



**Chulalongkorn University**

**Rajadapisek Sompoj Fund**

**Report**

**Development of Somatic Cell Nuclear Transfer  
Technique for Biomedical and Agricultural  
Research**

**By**

Mongkol Techakumphu  
Pranee Numchaisrika  
Ratajuk Rungsiwiwat  
Somchai Suwajanakorn  
Kamtorn Pruksananonda  
Pramuan Virutamasen

**February 2004**

### Acknowledgement

- This study was supported by Rajadapisek Sompoj Fund (3/2545), Chulalongkorn University. It was performed in collaboration between the Department of Obstetric Gynaecology and Reproduction, Faculty of Veterinary Science and Reproductive Unit, Department of Obstetrics Gynaecology, Faculty of Medicine.
- The authors wish to thank;
  - The Zoological Park Organization, Thailand for supporting the micromanipulation instrument
  - The Royal Golden Jubilee, Thailand Research Fund for supporting our RGJ-PhD candidate to participate in this project.
  - The staff of OGR, Vet. CU and OG, Med CU for valuable helps
- The manuscript was revised by Dr. Terry Heard, Former Editor of Pig Journal, UK.

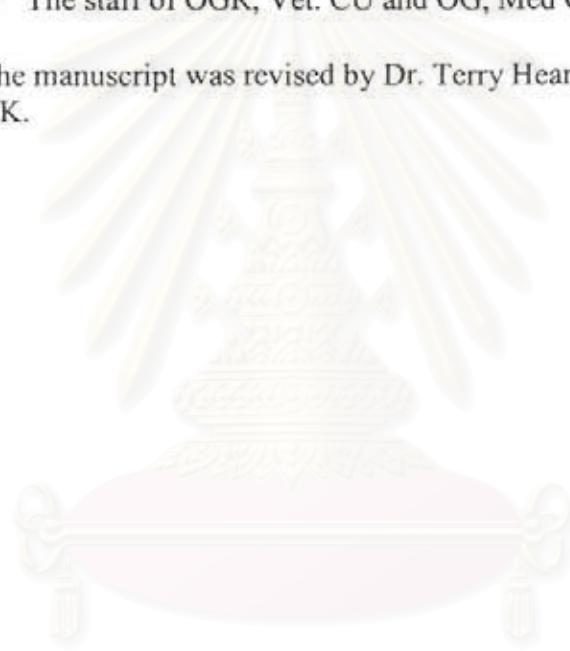

สถาบันวิทยบริการ  
จุฬาลงกรณ์มหาวิทยาลัย

**Subject:** Development of Somatic Cell Nuclear Transfer Technique for Biomedical and Agricultural Research  
**Investigators:** Mongkol Techakumphu, Pranee Numchaisrika, Ratajuk Rungsiwiwat, Somchai Suvajanakorn, Kamtom Prugsananon and Pramuan Virutamasen  
**Year:** February 2004

### Abstract

The objective of the studies was to develop somatic cell nuclear transfer by using the rabbit as a model in biomedical and agricultural research. The experiments are described in nine chapters:

- Chapter 1: Introduction
- Chapter 2: Superovulation and oocyte recipient production in rabbits
- Chapter 3: A technique for adult and foetal fibroblast cell culture, for donor cell preparation in somatic nuclear transfer
- Chapter 4: Preliminary studies on somatic cell nuclear transfer in rabbits
- Chapter 5: *In vitro* development of rabbit cloned embryos using adult fibroblast cells, after post-activation treatment with cyclohexamide and 6-dimethylaminopurine
- Chapter 6: Development of rabbit cloned embryos using cumulus cells, serum-starved and non-starved fibroblast cells, as the donor nucleus
- Chapter 7: Development of cloned embryos from adult and foetal rabbit fibroblast cells
- Chapter 8: A comparison of a cell fusion technique and intracytoplasmic donor cell injection for producing cloned rabbit embryos
- Chapter 9: Conclusion

*In conclusion*, the whole processes of somatic nuclear transfer using cell fusion technique was developed. This included recipient oocyte preparation, donor cell preparation, enucleation of recipient oocytes, fusion and activation, nuclear transfer and *in vitro* culture of cloned oocytes to the morula and blastocyst stage. A failure of *in vitro* development was observed when using intracytoplasmic donor cell injection in both mice or rabbits. Further studies will focus on the type of donor cells and interspecies cloning, embryonic stem cell development and the application of nuclear transfer in endangered species.

**Key words:** somatic cell nuclear transfer, rabbit, development

ชื่อโครงการวิจัย	การพัฒนาเทคนิคการย้ายฝากนิวเคลียสของเซลล์โรมาติกเพื่องานวิจัยทางการแพทย์และการเกษตร
ชื่อผู้วิจัย	มงคล เตชะกำพูน ปราณิ นำชัยศรีคำ รัฐจักร รังสิวิวัฒน์ สมชาย สุวจนกรณ์ กำธร พฤษพานานนท์ และประมวล วิฑูตเสนา
เดือนและปีที่ทำวิจัยเสร็จ	กุมภาพันธ์ 2547

### บทคัดย่อ

วัตถุประสงค์ของงานวิจัยนี้เพื่อพัฒนาเทคนิคการย้ายฝากนิวเคลียสของเซลล์โรมาติกเพื่องานวิจัยทางการแพทย์และการเกษตรโดยใช้กระต่ายเป็นต้นแบบในการพัฒนา รายงานวิจัยนี้แบ่งเป็น 9 บท ดังนี้

- บทที่ 1 บทนำ
- บทที่ 2 การกระตุ้นเพิ่มการตกไข่และการผลิตโอเอสโตรเจนในตัวรับในกระต่าย
- บทที่ 3 เทคนิคในการเลี้ยงเซลล์ไฟโบรบลาสต์จากกระต่ายที่โตเต็มวัยและฟิวส์เพื่อใช้ในการย้ายฝากเซลล์โรมาติกนิวเคลียส
- บทที่ 4 การศึกษาเบื้องต้นการย้ายฝากนิวเคลียสด้วยเซลล์โรมาติกในกระต่าย
- บทที่ 5 การพัฒนาในหลอดทดลองของตัวอ่อนกระต่ายที่ได้จากการโคลนโดยใช้เซลล์ไฟโบรบลาสต์จากกระต่ายที่โตเต็มวัยภายหลังการกระตุ้นด้วยไฟฟ้าร่วมกับสาร cyclohexamide และ 6-dimethylaminopurine
- บทที่ 6 การพัฒนาของตัวอ่อนกระต่ายที่ได้จากการโคลนโดยใช้เซลล์ตัวมูลัส และเซลล์ไฟโบรบลาสต์ที่อดอาหารและไม่อดอาหารเป็นตัวให้นิวเคลียส
- บทที่ 7 การพัฒนาของตัวอ่อนจากที่ได้จากการโคลนโดยใช้เซลล์ไฟโบรบลาสต์จากกระต่ายที่โตเต็มวัยและจากฟิวส์
- บทที่ 8 การเปรียบเทียบการผลิตตัวอ่อนกระต่ายจากการโคลนด้วยวิธีการเชื่อมเซลล์และการฉีดนิวเคลียสเข้าเซลล์
- บทที่ 9 สรุป

สรุปจากการศึกษาครั้งนี้ได้ทำการพัฒนาการย้ายฝากเซลล์โรมาติกนิวเคลียส ซึ่งประกอบด้วยวิธีการเตรียมโอเอสโตรเจนตัวรับ วิธีการเตรียมนิวเคลียสตัวให้ วิธีการดูแลสารพันธุกรรมออกจากเซลล์ตัวรับ การเชื่อมและการกระตุ้นเซลล์ให้หลอมรวมกัน การย้ายฝากเซลล์ตัวให้ไปยังเซลล์ตัวรับ และการเลี้ยงโคลนตัวอ่อนในหลอดทดลองจนถึงระยะมอรูลาและบลาสโตซิส อย่างไรก็ตามพบว่าการใช้เทคนิคการฉีดนิวเคลียสเข้าเซลล์ไม่เหมาะสมในการผลิตโคลนตัวอ่อนทั้งในหนูเม้าส์และกระต่าย งานวิจัยที่จะพัฒนาต่อไปคือการศึกษาชนิดของเซลล์ตัวให้ชนิดต่าง ๆ ต่อการพัฒนาของโคลนตัวอ่อน การศึกษาการโคลนตัวอ่อนข้ามสายพันธุ์สัตว์ การศึกษาด้านเซลล์ต้นแบบโดยร่วมกับเทคนิคการย้ายฝากนิวเคลียส รวมทั้งการศึกษากายการย้ายฝากนิวเคลียสในสัตว์ที่ใกล้จะสูญพันธุ์

คำสำคัญ: การย้ายฝากนิวเคลียสของเซลล์โรมาติก กระต่าย การพัฒนาในหลอดทดลอง

## Table of contents

	page
Acknowledgement	i
Abstract (English)	ii
Abstract (Thai)	iii
Table of contents	iv
Lists of Tables	v
Lists of Figures	vi
Lists of Symbols	vii
Chapter 1: Introduction	1-8
Chapter 2: Superovulation and oocyte recipient production in rabbits	9-16
Chapter 3: A technique for adult and foetal fibroblast cell culture, for donor cell preparation in somatic nuclear transfer	17-21
Chapter 4: Preliminary studies on somatic cell nuclear transfer in rabbits	22-28
Chapter 5: <i>In vitro</i> development of rabbit cloned embryos using adult fibroblast cells, after post-activation treatment with cyclohexamide and 6-dimethylaminopurine	29-32
Chapter 6: Development of rabbit cloned embryos using cumulus cells, serum-starved and non-starved fibroblast cells, as the donor nucleus	33-38
Chapter 7: Development of cloned embryos from adult and foetal rabbit fibroblast cells	39-43
Chapter 8: A comparison of a cell fusion technique and intracytoplasmic donor cell injection for producing cloned rabbit embryos	44-52
Chapter 9: Conclusion	53

## Lists of Tables

Table	Details	Chapter	Page
1.1	Projections for in-field applications of transgenic livestock	1	6
2.1	Mean ( $\pm$ SD) of ovulation, follicles and recovered oocytes per female and recovery rate after superovulation	2	13
2.2	Ovulations and oocyte production from superovulated doe rabbits	2	14
4.1	<i>In vitro</i> development of reconstructed rabbit embryos after fusion with cumulus and fibroblast cells	4	25
5.1	<i>In vitro</i> development of cloned rabbit embryos	5	30
6.1	The <i>in vitro</i> development of cloned rabbit embryos using cumulus cells, serum-starved and non-starved fibroblast cells, as donor nucleus	6	35
7.1	<i>In vitro</i> development of cloned rabbit embryos using adult fibroblasts and starved and non starved foetal fibroblasts	7	40
7.2	The ratio of oocytes with the MII close to the polar body (PB) and far from the polar body, when using young oocytes	7	41
8.1	The production cloned mice embryos by an intracytoplasmic donor cell injection technique	8	50
8.2	A comparison of the cloned rabbit embryos produced using a cell fusion technique and an intracytoplasmic donor cell injection	8	50

## Lists of Figures

Figure	Details	Chapter	Page
1.1	Merge of nuclear transfer and transgenesis technology to produce the transgenic animal	1	5
2.1	A New Zealand White, mature female used in the experiment	2	10
2.2	A schematic of the timing of FSH-HCG treatments in the rabbit	2	11
2.3	Processes of oocyte collection by ovariectomy	2	12
2.4	Matured oocytes with 1 <sup>st</sup> polar body (arrow) after removing surrounding cumulus cells	2	13
3.1	Fibroblast cell culture from ear-skin biopsy	3	18
3.2	The tissue preparation technique	3	19
4.1	The process of somatic cell cloning in rabbits	4	24
4.2	Cloned rabbit embryo after somatic cell nuclear transfer	4	26
5.1	Cloned morula (a) and blastocyst (b) after using an adult rabbit fibroblast cell as the donor cell	5	31
6.1	A fibroblast cell (arrow) being transferred to an enucleated oocyte	6	36
6.2	Cloned embryos at different stages	6	37
7.1	Schematic figure of metaphase II location as related to 1 <sup>st</sup> polar body. The MII (metaphase) is commonly adjacent to the 1 <sup>st</sup> polar body in a young oocyte (15 hpc, A), but in aged oocytes (20 hpc), at least 3 positions; a, b, c of MII can be found (B)	7	41
7.2	A rabbit oocyte before enucleation, stained with Hoechst 33342 to visualize the metaphase II	7	42
8.1	Four to six week-old of C57BL/6J (a) and ICR (b) female mice	8	45
8.2	Matured mouse oocytes collected after superovulation	8	46
8.3	The procedure for intracytoplasmic nuclear injection in mice	8	47
8.4	An intracytoplasmic cell injection in rabbit oocyte	8	49

## Lists of Symbols

2-C = 2-cell stage  
 6-DMAP = 6-dimethylaminopurine  
 $\text{Ca}^{++}$  = calcium  
 CHX = cyclohexamide  
 CL = corpus luteum, corpora lutea  
 cm = centrimetres  
 D = Day  
 DMSO = Dimethyl sulfoxide  
 FCS = foetal calf serum  
 FSH = Follicle Stimulating Hormone  
 hCG = Human Chorionic Gonadotropin  
 PMSG = Pregnant Mare Serum Gonadotropin  
 LH = Luteinizing Hormone  
 h = hour  
 hpc = hours post coitum  
 kg = Killogram  
 kV = kilovolts  
 min = minute  
 mm = millimole  
 $\text{ml}^{-1}$  = millilitres  
 $\text{Mg}^{++}$  = Magnisium  
 mg = milligrams  
 $\mu\text{m}$  = micrometers  
 $\mu\text{s}$  = microseconds  
 n = number  
 NT = nuclear transfer  
 SNT = somatic nuclear transfer  
 OVH = Ovariohysterectomy  
 PBS = Phosphate Buffer Saline  
 PVP = Polyvinylpyrrolidone



# Chapter 1

## Introduction

Nuclear transfer techniques (NT) are one of the most advanced reproductive technologies of the past decade. NT was originally developed in amphibians more than 60 yr ago by Speman (1938) and later introduced to mammals in 1983 by McGrath and Solter. In 1997, Willadsen and his collaborators demonstrated that sheep oocytes, at a matured stage, were an appropriate cytoplasm for reprogramming the donor nucleus after transplanting which supported the further development of cloned embryos. Their work also advanced the application of NT in farm animals. In the beginning, donor cells could only be collected from blastomeres or the inner cell mass of the preimplantation embryo, the breakthrough event of cloning was announced by Dr. Willmut and his collaborators in 1997 with the birth of *Dolly*, the first cloned sheep, using somatic differentiated cells. Since then, a large number of advanced researches on nuclear transfer have been made.

Many offspring from somatic nuclear transfer have been born involving many species, including cattle, sheep, goats and swine (review by Niemann and Kues, 2003a). A variety of cell types of embryonic, fetal and somatic origin have been successfully used as donor cells for nuclear transfer. However, the overall efficiency is still quite low and the average percentage of live offspring does not exceed 1 to 3% of transferred cloned embryos. It is now accepted that the objective of nuclear transfer, or cloning of animals, does not only allow the production of a number of genetically identical animals but can also aid the preservation of endangered wild animals. Furthermore pet cloning for emotional reasons and horse cloning for genetic preservation have also been a goal of cloning. Cloning technology could also find a major application in the production of transgenic animals for biomedical purposes because any desired genetic modifications can be produced in cultured cells and the value of such transgenic animals can be substantial (Galli et al., 2003).

### ***Technique of nuclear transfer***

The nuclear transfer procedure was developed using the basic techniques proposed by McGrath and Solter (1983) and utilizing either *in vivo* or *in vitro* matured oocytes as the cytoplasm recipient (cytoplasm). The genetic material, metaphase II and the first polar body of the cytoplasm, is removed using a micropipette, in a technique called "enucleation". Following enucleation of the oocyte, a donor nucleus (karyoplast) is transferred into the perivitelline space and attached to the surface of the enucleated oocyte called, or donor cell, which can be injected directly into the cytoplasm (Wakayama et al., 1998). The enucleated oocyte and donor cell are fused by electrofusion. Electrofusion is highly species-dependent in terms of its duration, amplitude of the pulse fusion medium and equilibration to the fusion medium. After fusion, the oocyte is activated either by chemical or by mechanical stimulation. Successful activation initiates further development into cleaved embryos, morula or blastocysts, which can be followed by transfer to a suitable recipient.

Before 1997, nuclear transfer was limited only to karyoplasts of embryonic origin. The karyoplast came from blastomeres or the inner cell mass of preimplantation stage embryos. This technique was called “**embryo cloning**”. Nowadays, “**somatic cell cloning or nuclear transfer (SNT)**” is practiced. Various cell types from many tissues (cumulus, oviduct, uterus, liver, skin, from adults, newborn and embryos) have been investigated for the production of cloned animals. In mice other cell types, foetal ovary and testis, immature Sertoli cells, spleen, thymus, macrophages from three strains of mice has been reviewed by Thibault, 2003. Cultured embryonic stem cells (ES cells) or ES-like cells have also been used as karyoplasts for nuclear transfer. The potential for nuclear transfer to be used in the production of transgenic animals depends greatly on the transfection of somatic, ES and/or embryonic germ cells (EG cells).

### ***Applications of nuclear transfer***

There are several applications for NT in the field of animal production and human medicine:

*For animal production;* It can increase the production of milk and meat as well as help better growth performance and disease resistance. NT will also assist in the production of genetically identical twins and more rapid genetic improvement, especially in males used for artificial insemination. NT can be used for the preservation and propagation of companion animals such as dogs, cats and horses and as a tool for the conservation of genetic material from endangered or unique animals. It also has a role in the production of biomedical models for human disease research (Long et al., 2003).

*For human medicine,* NT technology provides an alternative method for cell-based transgenesis using domestic species by offering genetic modifications. The genetically modified livestock can produce human therapeutic proteins in their milk and organs for xenotransplantation.

### ***Application in animal production***

#### ***Production of identical twins***

The production of genetically identical animals using NT has been steadily developed, the classical technique can be performed by embryo bisection, as developed by Dr. Willadsen in 1979. It was a most reliable technique for the production of identical twins. However, a disadvantage was the low number of identical twins. It was found that the maximum yield per embryo was limited to 2-4 offspring at best (>4, results in the complete loss of developmental competence, as the excessive reduction of cell numbers produces small blastocyst vesicles with no inner cell masses). Repeated embryo splitting does not result in greater numbers of progeny. However, the timing of subsequent cleavage divisions and blastocyst formation is unaffected by a reduction in cell numbers, as it does not change the original development program of the embryo. Furthermore, embryo splitting and blastomere separation is not highly compatible with embryo cryopreservation and as a result, most commercial transfer of half-embryos has been limited to fresh embryos.

NT technology is more advantageous than embryo bisection as it increases the number of identical twins and so development programs have been reprogrammed. It is hoped that cloning cows by nuclear transfer can be used to create ideal milk and meat animals which will be economically beneficial to the beef and dairy industries. Commercial interest in cloning technology was originally centered around the production of large numbers of genetically superior animals for agricultural purposes. Around 10 years ago there were several American companies setting up and putting in place, extensive research and development cloning programs, however, these could not overcome embryo cloning inefficiencies and the difficulty of producing multiple generation calves via re-cloning (Stice et al., 1998). In addition, we have seen a high rate of late abortions and early postnatal deaths, an abnormally high birth weight called "large calf syndrome" (LOS), neonatal anomalies, particularly when somatic cells are used as the donors of nuclei; Rates as high as 40-74% have been reported (Renard et al., 1999). This may relate to one deficiency or a combination of deficiencies, in either the nuclear transfer procedure itself, leading to incomplete nuclear reprogramming of the cultured donor cells, or in the *in vitro* maturation and embryo culture systems. These deficiencies, either collectively or singularly, may lead to inappropriate patterns of gene expression at specific key stages during embryo, fetal or placental development, all contributing to pregnancy loss (Wells et al., 1999). These are the reason why cloning is still not performed commercially on a large scale, and will not be until better pregnancy rate and normal development pre and postpartum are available.

From the past to the present, genetic selection has been an important tool for adapting animal production to various environmental and market demands. In cattle, rapid genetic improvements are limited by the low reproductive efficiency of cows and the large generation interval. Heyman and Renard (1992) suggested that NT could provide a great contribution to the genetic improvement of cattle. The rapid diffusion of genetic progress can be expected with a greater number of clones. A clone by 5 females, evaluated on their own production, is equivalent to the genetic value of a bull of the same merit, evaluating 25 of his daughters. In beef breeds, the utilization of a few clones would allow much better evaluation of maternal influence.

#### *Conservation of genetic materials from endangered or unique animals*

Advances in cloning offer a way to preserve and propagate endangered species that reproduce poorly in zoos. When their habitats can be restored they can be reintroduced to the wild. Saving a species from extinction is one of the more recent aims of embryo cloning. In January 2001, the world's first cloned endangered species, a baby Asian ox, Gaur, and going by the name of "Noah", was born on January 8<sup>th</sup>, in Iowa state, USA. Other endangered species to be cloned will be those whose reproduction has already been well studied. The African wild cat, an Indian desert cat, an eland, a red deer, a cheetah and a giant panda will be primary candidates. Nowadays, it is possible to preserve the somatic cells of captive and non-captive wild animals by biopsy material which can be cultured and preserved in liquid nitrogen, and used to maintain wildlife conservation. The *frozen zoo* or *zoo bank* has been developed in many countries, including Thailand. From our preliminary results (unpublished data), we have preserved at least 7 species of wild cats from Dusit and Kao Kiew Zoos. Recently, pieces of skin and muscle from a dead gibbon, a giraffe and

a stillborn Asian elephant (*Elephas maximus*) have been cultivated and successfully stored in liquid nitrogen. In collaboration with ZPO (Zoological Park Organization of Thailand), various endangered species will be preserved and research on cytological analysis will be performed.

#### Application in human medicine

##### *The Merger of nuclear transfer and transgenesis*

The ability to produce live offspring by NT from somatic cells provides a route for the precise genetic manipulation of animal species (Polejaeva and Campbell, 2000). *Transgenesis is a word defined as the alteration of genomic information with the intent to modify a specific physical trait of an animal* (Brink et al., 2000). Niemann and Kues (2000) suggested that *gene transfer is defined as the introduction of a protein coding DNA fragment into the host genome with the goal that the foreign DNA contribute to the protein synthesis of the host organism e.g. the transgenic animal*. Denning and Priddle (2003) suggested that nuclear transfer technology now provides an alternative route for cell-based transgenesis in domestic species, offering new opportunities for genetic modification. Farm animals, such as cattle and pigs, can provide human therapeutic proteins in their milk and or organs for xenotransplantation. They can provide the means to resist diseases such as spongiform encephalopathies by using NT from engineered, cultured somatic cells.

There are at least five techniques for transgenics that can be developed:

- Pronuclear microinjection of recombinant DNA
- Sperm-mediated DNA
- Retrovectors
- Embryonic stem cell transfection by injecting them into the blastocyst cavity
- Somatic nuclear transfer  
(Wheeler and Walters, 2001)

Among the techniques of transgenesis, NT has an advantage by accelerating the time scale, by prescreening the donor cells for the optimal expression of the desired trait *in vitro*, allowing 100% transgenic offspring to be produced (Niemann and Kues, 2000). DNA transfection was performed in cultivated foetal fibroblasts, screened for transgene integration and later transferred into enucleated cytoplasts (Niemann and Kues, 2003). The blastocysts obtained after the NT process were transferred to a synchronized recipient who produced transgenic offspring. It has been reported that NT in pigs, using genetically modified somatic cells as donor cells, improved the efficiency of the transgenesis compared to techniques such as pronuclear injection (Nagashima et al., 2003). The merger of nuclear transfer and transgenesis technology was presented in Fig. 1.1.

Transgenic animals are useful in the study of many areas:

- 1) Biological, biomedical and genetic research, such as gene regulation and developmental biology, oncogenic research, mechanisms of regulation and cell interaction in the immune system, models of human genetic diseases, mechanisms for controlling growth and basic mechanisms of biology and genetics

- 2) Livestock production
  - 3) Modification of milk
  - 4) Modification of growth and carcass composition
  - 5) Modification of disease resistance
  - 6) Modification of reproductive performance and proliferacy
  - 7) Modification of cell and tissue characteristics
- (Wheeler and Walters, 2001)

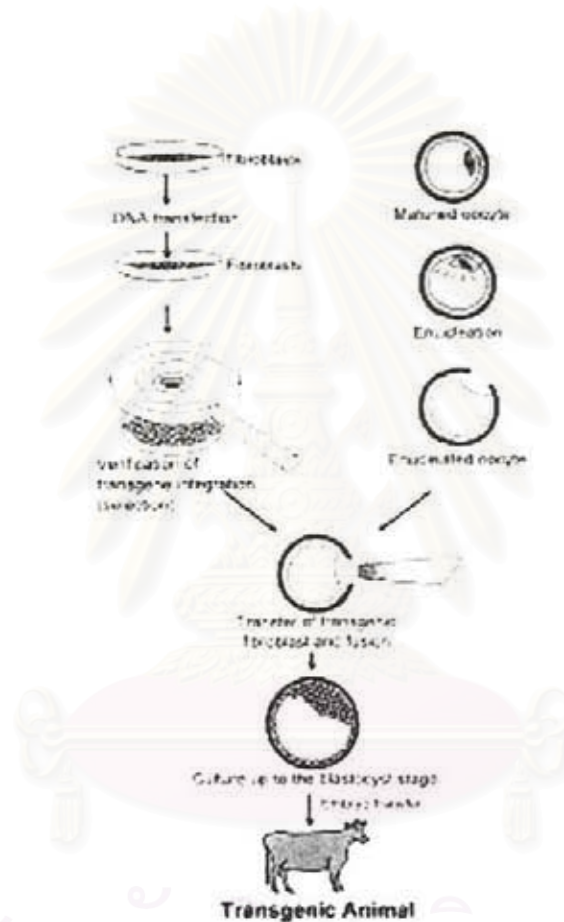

Figure 1.1 The merger of nuclear transfer and transgenesis technology to produce the transgenic animal (Niemann and Kue, 2000)

### *Xenotransplantation*

In the world today, there is a acute shortage of appropriate organs such as a heart, kidney, liver and pancreas for transplantation. Many patients are waiting for an organ donation and some of them have no chance of availability. The transplantation of organs between species, e.g. from animals to humans is called “*xenotransplantation*”. It is the solution of choice and has been studied for more than a decade. A baboon heart can be transplanted in a human body and the patient can survive for a normal life time. The pig seems to be the optimal donor animal because

its physiology is similar to human, with short reproductive cycles, large litter sizes and its organs a similar size to human organs, they can be produced in good condition (Piedrahita, 2000; Niemann and Kues, 2003). The production of transgenic pigs carrying human genes, by the technique of gene targeting and gene knockout technology will be a challenging issue for the future. At the moment, hyperacute reactions (HAR) are a major obstacle hampering xenotransplantation from pigs to humans. The 1-3 galactosyl transferase (1-3Gal) gene needs to be eliminated in order to prevent HAR. Furthermore, some viruses, such as the retroviruses need be eradicated, to prevent transmission to man.

Apart from xenotransplantation, using knockout technology, low fat, fat-free milk and hypoallergic milk, by using a knockout-lactoglobulin gene, can modify milk composition. This biomedical area is expected to be practical before the year 2010 (Table 1.1).

Table 1.1: Projections for in-field applications of transgenic livestock (Niemann and Kues, 2003)

	Year
Biomedical traits	
Recombinant pharmaceutical proteins	<2004
Xenogenic cells/tissue	>2005
Xenotransplantation of solid organs	>2008
Agricultural traits	>2010
Dairy products	>2008
Meat and meat products	>2005
Wool products	

#### *Transspecies nuclear transfer*

Transpecies nuclear transfer allows the generation of human embryonic stem cells from a somatic cell of a patient by fusion with an enucleated animal oocyte. Not only a somatic cell, but the blastomere from excess human IVF embryos can become donor cells that produce human cells lines through NT. It has been demonstrated that a bovine cytoplasm can reprogram the chromatin of human donor cells. These stem cells could be used to replace damaged neuronal cells or assist in the treatment of immune disorders. However, this kind of research may not be supported by research agencies in Thailand.

#### *ES cell lines establishment*

Therapeutic cloning is one of the applications making use of NT. Normal cells, from a patient suffering from diseases, such as Parkinson disease, diabetes mellitus (dB), spinal cord injury, Alzheimer's disease etc. will be used as donor cells that are transferred to an enucleated oocyte, which can produce an embryo of the blastocyst stage. The inner cell mass will be isolated as embryonic stem cells (ES cells). The cells can be controlled and differentiated as neuronal cells, islet of Langerhan cells or cardiovascular cells etc by supplying specific growth factors.

It is clearly that nuclear transfer is one of the advanced technologies that can serve either animal production in terms of breeding improvements and endangered

species conservation or for humans, in terms of therapeutic cloning. It can also be used for studying basic knowledge in cell biology. Furthermore, nuclear transfer in cooperation with genetic modification, will served transgenic technology in the future. Since the success of somatic cell cloning in sheep, a report of SNT in rabbits was presented by French researchers (Chesne et al., 2001). In Thailand, SNT has been developed in many species including cattle, buffalo, pig, goat, cat and rabbits (review by Parnpai, 2003). The rabbit provides a good model for other species and will help to elucidate the fundamental mechanisms involved in the nuclear transfer process (Dinnyes et al., 2001)

The objectives of the first phase of the studies were as followed:

1. Superovulation and oocyte recipient production
2. Somatic cell, nuclear transfer development using fibroblast and cumulus cells from adults and foetuses
3. Somatic cell, nuclear transfer by cell fusion techniques and whole cell intracytoplasmic injection

In this project, the rabbit was used as the model for cloning development, in order to apply this special science for both mankind and other animal species. The outcome of this project will help medical therapy of humans and breeding improvement in farm animals.

### *References*

- Brink M.F, Bishop M.D, Pieper F.R. 2000. Developing efficient strategies for the generation of transgenic cattle which produce biopharmaceuticals in milk. *Theriogenology*. 53(1):139-48.
- Chesne, P., Adenot, P.G., Viglietta, C., Baratte, M., Boulanger, L. and Renard, J.P. 2002. Cloned rabbits produced by nuclear transfer from adult somatic cells. *Nat. Biotechnol.* 20: 366-369.
- Denning, C. and Priddle, H. 2003. New frontiers in gene targeting and cloning; success, application and challenges in domestic animals and human embryonic stem cells. *Reproduction*. 126:1-11.
- Dinnyes, A., Dai, Y., Barber, M., Liu, L., Xu J., Zhou, P. and Yang, X. 2001. Development of cloned embryos from adult rabbit fibroblasts: Effect of activation treatment and donor cell preparation. *Biol. Reprod.* 64:257-263.
- Galli, C., Duchi, R., Crotti, G., Turini, P., Ponderato, N., Colleoni, S., Lagutina, I. and Lazzari, G. 2003. Bovine embryo technologies. *Theriogenology* 59: 599-616.
- Heyman, Y. and Renard, J.P. 1992. Embryo cloning by nuclear transfer in cattle and rabbits. *Jornadas Técnicas Sobre Biotecnología Aplicada a la Reproducción Animal. Feria Internacional Ganadera Quinto Centenario, Zafra* 92 5p.
- Long, C.R., Walker, S.C., Tang, R.T., and Westhusin, M.E. 2003. New commercial opportunities for advanced reproductive technologies in horses, wildlife and companion animals. *Theriogenology*. 59:139-149.
- McGrath, J. and Solter, D.. 1983. Nuclear transplantation in the mouse embryo by microsurgery and cell fusion. *Science*. 220:1300-1302.

- Nagashima, H., Fujimura, T., Takahashi, Y., Kurome, M., Wako, N., Ochiai, T., Esaki, R., Kano, K., Saito, S., Okabe, M., and Murakami, H. 2003. Development of efficient strategies for the production of genetically modified pigs. *Theriogenology*. 59:95-106.
- Niemann, H. and Kues, W.A. 2000. Transgenic livestock: premises and promises. *Anim. Reprod. Scie.* 60-61:277-293.
- Niemann, H. and Kues, W.A. 2003. Application of transgenesis in livestock for agriculture and biomedicine. *Anim. Reprod. Scie.* (in press).
- Parnpai, R. 2003. Mammalian somatic cell cloning status in Thailand. In: The 2<sup>nd</sup> Chulalongkorn Reproductive Biotechnology Symposium on Stem cell s and somatic cell cloning research: Present status and future trends. 3-4 December 2003, Chulalongkorn University, Bangkok, Thailand, p18-26.
- Piedrahita, J.A. 2000. Targeted modification of the domestic animal genome. *Theriogenology*. 53:105-116.
- Polejaeva, I.A. and Campbell, K.H.S. 2000. New advances in somatic cell nuclear transfer application in transgenesis. *Theriogenology*. 53:117-126.
- Prather, R.S., Hawley, R.J., Carter, D.B., Lai, L. and Greenstein, J.L. 2003. Transgenic swine for biomedicine and agriculture. *Theriogenology*. 59: 115-123.
- Renard, J.P., Chastant, S., Chesne, P., Richard, C., Marchal, J., Cordonnier, N., Chavatte, P. and Vignon, X. 1999. Lymphoid hypoplasia and somatic cloning. *The Lancet*. 353:1489-1491.
- Spemann, H. 1938. Embryonic development and induction. New York: Hafner Publishing Co., 210-211.
- Stice, S.L., Robl, J.M., Ponce de Leon, F.A., Jerry, J., Golueke, P.G., Cibelli, J.B. and Kane, J.J. 1998. Cloning: New breakthroughs leading to commercial opportunities. *Theriogenology*. 9:129-138.
- Thibault, C. 2003. Recent data on the development of cloned embryos derived from reconstructed eggs with adults cells. *Reprod. Nutri. Dev.* 43:303-324.
- Wells, D.N., Pavla, M.M. and Tervit, H. R. 1999. Production of cloned calves following nuclear transfer with cultured adult mural granulosa cells. *Biol. Reprod.* 60:996-1005.
- Wheeler, M.B. and Walters, E.M. 2001. Transgenic technology and application in swine. *Theriogenology* 56: 1345-1369.
- Willadsen, S.M. 1979. A method for culture of micromanipulated sheep embryos and its use to produce monozygotic twins. *Nature*. 277: 298-300.
- Wilmut, I, Schnieke, A.E, McWhir, J., Kind, K.L., Campbell, K.H.S. 1997. Viable offspring derived from fetal and adult mammalian cells. *Nature*. 385:810-813.
- Wakayama, T., Perry, A.C.F., Zuccotti, M., Johnson, K.R., Yanagimachi, R. 1998. Full-term development of mice from enucleated oocytes injected with cumulus cells. *Nature*. 394:369-374.



## Chapter 2

### Superovulation and Oocyte Recipient Production in Rabbit

#### Abstract

The objective of the experiment was to study the oocyte recovery rate and their quality after superovulation, in order to use these oocytes as recipient cytoplasm in a nuclear transfer program.

**Experiment I:** To study the appropriate dose of gonadotropin hormone for superovulation in rabbit. A total of 38 New Zealand White, mature does were divided into 3 groups according to the dose of Follicle Stimulating Hormone (FSH) that was given; 21 mg (group A), 28 mg (group B) and 40 mg (group C). Five IM injections of FSH were given at 12 h intervals in increasing doses for groups A and B and as a constant dose for group C. Ovulation was induced using 100 iu human chorionic gonadotropin (hCG) and mating with a vasectomized buck. The oocytes were collected following ovariectomy and direct flushing. The number of corpora lutea (CL), non hemorrhagic and hemorrhagic follicles were counted. The numbers CL was  $24.5 \pm 8.8$ ,  $21.3 \pm 11.6$  and  $20.4 \pm 8.6$  ( $P > 0.05$ ) respectively. The recovery rate of group A, 77.7%, was higher than those of group B, 55.7% and C, 50.9% ( $P < 0.001$ ). A higher number of recovered oocytes was found in group A,  $19.1 \pm 8.0$  than those of group B,  $11.8 \pm 7.0$  ( $P < 0.01$ ) and group C,  $10.4 \pm 8.3$  ( $P < 0.001$ ). More than 90% of the recovered oocytes in every group were morphologically normal. This study showed that the dose of FSH influenced the oocyte recovery rate and the number of oocytes collected from each female.

**Experiment II:** To study the effect of the season on oocyte recovery in superovulated rabbit does. A total of 46 New Zealand, mature doe rabbits, with an average weight of 3.0 kg, were superovulated with 21 mg FSH. All procedures were followed as in Exp. I. The studies were performed from August 2002 to March 2003. It was found that the ovulation number was  $27.8 \pm 12.0$  ( $n=1277$ ) while the mean number of oocytes collected was  $21.0 \pm 10.5$  ( $n=965$ ), representing a recovery rate of  $76.9 \pm 20.6\%$ . The season seemed to influence the ovulation and recovery of oocytes. However, it was found that most of recovered oocytes could be used as recipient cytoplasm in the somatic cell nuclear transfer program.

**Key words:** oocyte production, rabbit, superovulation

### ***Introduction***

In order to develop somatic cell nuclear transfer, good quality recipient oocytes are required. The oocyte at metaphase II was suitable as a recipient cytoplasm and was capable of reprogramming the nuclear donor with a high degree of success (Willadsen, 1986). In farm animals, immature oocytes were collected from a slaughterhouse or by surgical oocyte aspiration and later matured *in vitro*, while in laboratory animals, mature oocytes were collected by oviduct flushing, after *in vivo* maturation. The rabbit is one of the more interesting animal models as it provides a high number of recipient oocytes per donor. Rabbit oocytes can be produced using the technique of superovulation with exogenous gonadotropin and collected by direct tubal flushing (Kauffman et al., 1998; Yang, 1991). Superovulation treatment can increase, by a factor of two- or three, the number of embryos as compared to natural ovulation. There are two types of gonadotropins; Pregnant Mare Serum Gonadotropin (PMSG) and Follicle Stimulating Hormone (FSH) that can be used for superovulation in rabbits. Treatment with PMSG can often induce an unsatisfactory result and Techakumphu (1987) found that Follicle Stimulating Hormone (FSH) was effective in providing a high number of embryos per animal. FSH can be given twice a day, at 12 h intervals over a period of 3 days and an injection of Luteinizing Hormone (LH) is injected on the following day, at the same time as natural or artificial mating for ovulation induction (Tsunoda et al., 1980). The objective of these experiments was to study the oocyte recovery rate and their quality, after superovulation, in order to use these oocytes as cytoplasm recipients in our nuclear transfer program. The effect of season on the superovulation treatment was also investigated.

### ***Materials and Methods***

The studies were designed in the form of two experiments:

#### ***Experiment I:***

A total of 38, six-month-old, New Zealand White, doe rabbits, weighing  $\geq 3.0$  kg were used (Fig. 2.1). These rabbits when 1.5 kg, were bought from a colony kept at the Department of Animal Husbandry, Faculty of Veterinary Science, Chulalongkorn University and raised in Nakorn Pathom province for 4 wks., before the experiment started. Then, they were housed in individual cages at 25°C with 12h of artificial light daily, in animal housing at the Department of Physiology, Faculty of Medicine, Chulalongkorn University. A concentrated diet, containing 14% protein and fresh water, was given *ad libitum*. Two vasectomized bucks were prepared for mating and raised under the same condition as the doe rabbits.

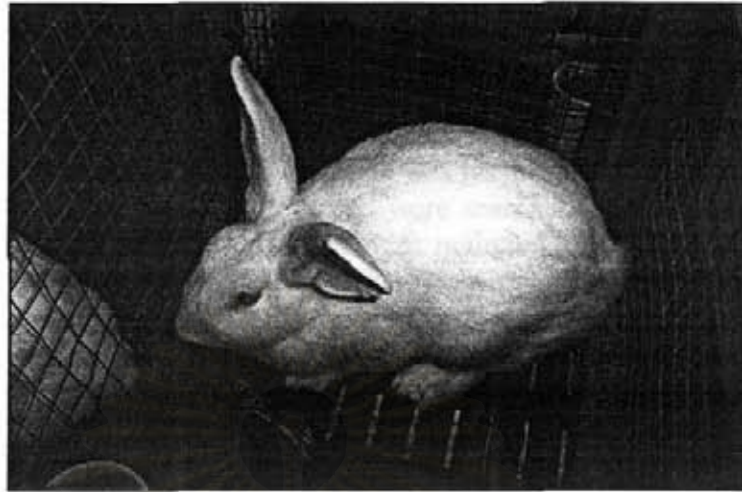

Figure 2.1: A New Zealand White, mature female used in the experiment

*Superovulation program:*

The animals were injected with Follicle Stimulating Hormone (FSH, Vetapharm®, Australia) intramuscularly using five injections at 12 h intervals in increasing doses for groups A and B and as a constant dose for group C, starting in the evening and continuing over 3 days. The three experimental groups were treated as follows: Group A: 21 mg FSH (n=15) (3,3+3,6+6), Group B: 28 mg FSH (n=12) (4,4+4,8+8) and Group C: 40 mg FSH (n=11) (8, 8+8, 8+8) (Fig. 2.2). Ovulation was induced by mating with a vasectomized buck and by injecting a 100 IU of intravenous Human Chorionic Gonadotropin (hCG, Chorulon®, Intervet, The Netherlands) (Schmidt et al., 1992). The dose of FSH was modified according to previous observations (Techakumphu, 1987). The rabbits were laparotomized, under general anesthesia 16 h post coitus and their genital tracts, kept in Phosphate Buffer Saline (PBS), were brought to the laboratory for oocyte flushing.

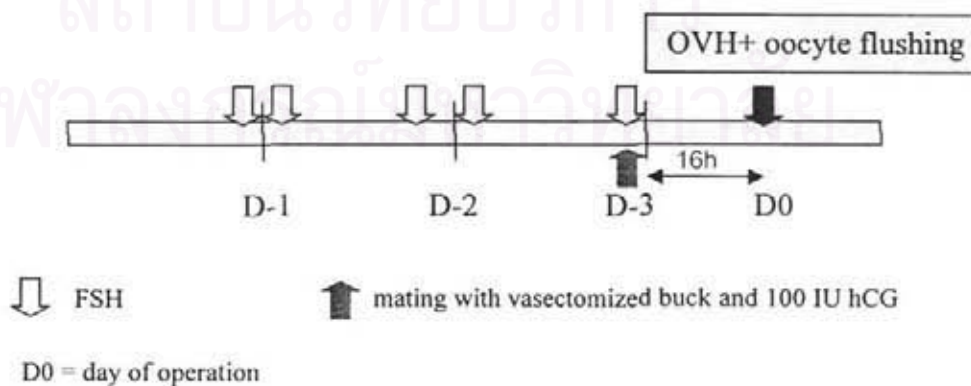

Figure 2.2: A schematic of the timing of FSH-HCG treatments in the rabbit

### *Oocyte collection*

Direct flushing of the oviduct as described previously by Techakumphu (1987) was used to collect the oocytes. A blunt-end 18 g needle was inserted through the uterine end to the fimbria and flushed using 10 ml of Phosphate Buffer Saline (PBS)+2% Fetal Calf Serum (FCS). Flushing was performed twice and the media were received a 35-mm petri dish. The oocytes were searched immediately under a 10X stereomicroscope and recovered oocytes were maintained in TCM 199 Hepes+10% FCS. They were then washed twice in fresh media and incubated in 0.5% Hyarulonidase (Sigma, USA) for 30 min. After the end of incubation, the cumulus cells around the oocyte were removed by pipetting. The oocytes were investigated under a microscope to ensure the presence of a 1<sup>st</sup> polar body, so they could be classified as a mature oocyte. The number of corpora lutea, non hemorrhagic and hemorrhagic follicles was counted. The oocyte recovery rate was compared with the number of corpora lutea in both ovaries.

The processes of oocyte collection are presented in Fig. 2.3.

### *Experiment II:*

A total of 46, six-month-old, New Zealand White, doe rabbits, weighing  $\geq 3.0$  kg were used in the experiment. The animals were treated with 21 mg FSH using the same protocol as in Experiment I. The experiment was conducted between August 2002 and March 2003.

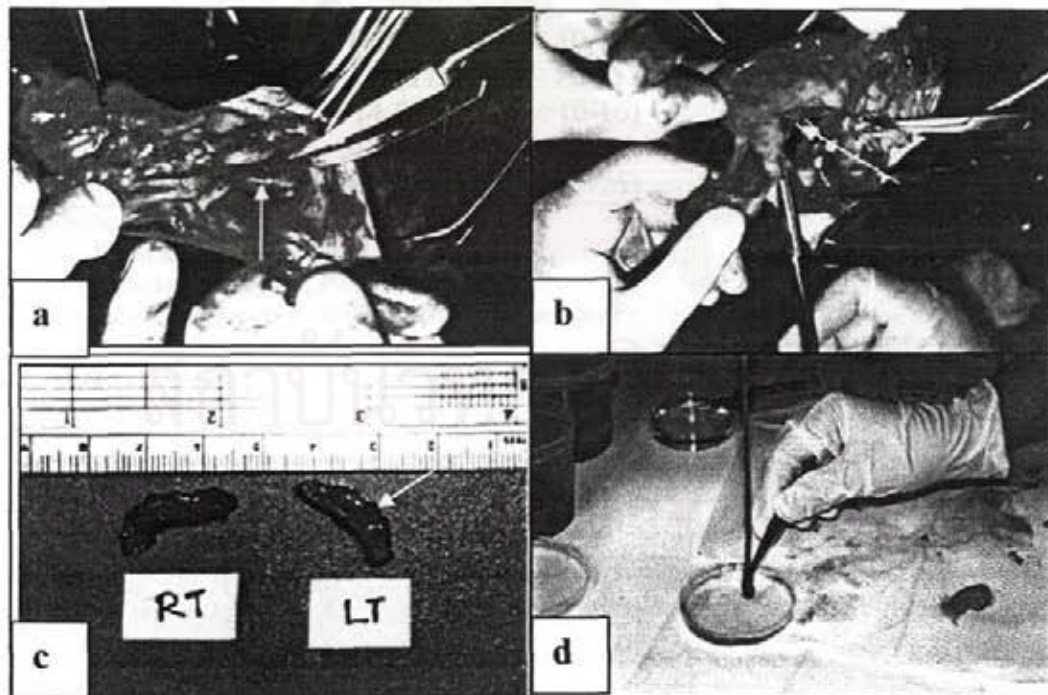

Figure 2.3. Processes of oocyte collection by ovariectomy

- the oviduct (arrow) was exposed at the incision site
- the oviduct (arrow) was removed
- the number of ovulations (arrow) in both ovaries were counted
- the oocytes were flushed directly from oviduct

### Statistical analysis

The number of ovulations, follicles and recovered oocytes per donor were compared according to the month of treatment, using a one-way analysis of variance and by the Chi-square test.

### Result

Table 1.2 shows the mean number of ovulations, and the mean number of non hemorrhagic and hemorrhagic follicles, per donor in each program which were significantly different ( $P>0.05$ ). The number of recovered oocytes per donor were higher in group A than in B and C ( $P<0.01$ ). A high variation in the ovulation rate and in the number of recovered oocytes was observed in all treatments. The recovery rate was highest in group A ( $P<0.001$ ). More than 90% of oocytes in all the treated groups were morphologically normal with homogenous cytoplasm and a first polar body (Fig. 2.4).

Table 2.1: Mean ( $\pm$ SD) of ovulation, follicles and recovered oocytes per female and recovery rate after superovulation

Program	No. of rabbit does	No. of ovulations	No. of follicles	No. of recovered oocytes	% Recovery rate
A	15	24.5 $\pm$ 8.6 (10-46)	8.9 $\pm$ 7.4 (0-30)	19.1 $\pm$ 8.0 <sup>a</sup> (7-33)	77.7 <sup>d</sup>
B	12	21.3 $\pm$ 11.6 (4-31)	7.5 $\pm$ 5.6 (0-16)	11.8 $\pm$ 7.0 <sup>b</sup> (2-23)	55.7 <sup>c</sup>
C	11	20.4 $\pm$ 8.6 (14-39)	10.5 $\pm$ 7.7 (1-25)	10.4 $\pm$ 8.3 <sup>c</sup> (4-23)	50.9 <sup>c</sup>

<sup>a, b</sup> significant difference,  $P<0.05$  (chi<sup>2</sup> test)

<sup>a, c</sup> significant difference,  $P<0.01$  (chi<sup>2</sup> test)

<sup>b, c</sup> no significant difference,  $P>0.05$  (chi<sup>2</sup> test)

<sup>d, c</sup> significant difference,  $P<0.001$  (analysis of variance)

สถาบันวิทยบริการ  
จุฬาลงกรณ์มหาวิทยาลัย

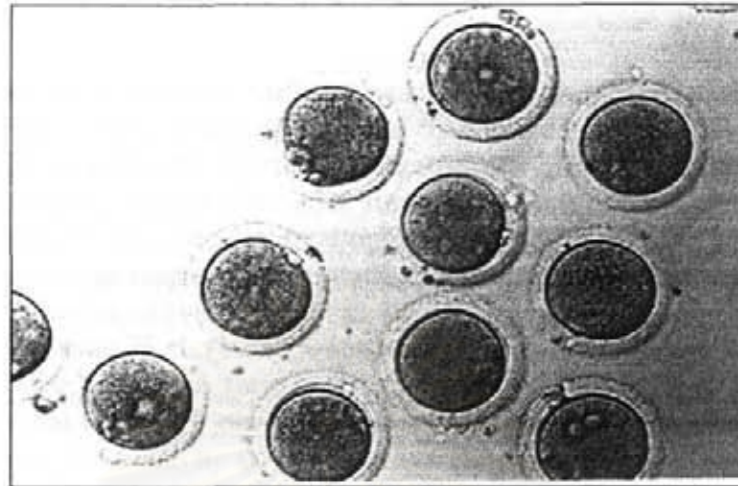

Figure 2.4: Matured oocytes with 1<sup>st</sup> polar body after removing surrounding cumulus cells (x200)

Table 2.2 shows the mean number of ovulations, oocytes per donor and the recovery rate over the period of August 2002 to March 2003. No experiments were performed in November and December. A high variation in ovulation rate and the number of recovered oocytes were observed in the treatments.

Table 2.2: Ovulations and oocyte production from superovulated doe rabbits

Month	No rabbits	Ovulations (mean±SD)	Oocytes (mean±SD)	Recovery rate
Aug-02	10	21.7±7.9 <sup>b</sup> (217)	12.9±4.22 <sup>b</sup> (129)	65±28%
Sep-02	8	25.3±8.14 <sup>b</sup> (202)	17.38±7.53 (139)	70.4±19.4%
Oct-02	10	28.7±8.64 <sup>b</sup> (287)	24±8.43 (240)	83±11%
Jan-03	6	32.17±12.3 (193)	27.8±11.7 <sup>a</sup> (167)	87±15.2%
Feb-03	6	44.7±14.7 <sup>a</sup> (268)	31.17±13.5 <sup>a</sup> (187)	69±16.7%
Mar-03	6	18.3±6.2 <sup>b</sup> (110)	17.2±7.5 (103)	90.28±15.2%
	46	27.8±12.0 (1277)	21.0±10.5 (965)	76.7±20.4%

<sup>a, b</sup> significant difference,  $P < 0.05$  (chi<sup>2</sup> test)

### **Discussion**

In rabbits, it is usual for the embryos to be collected post-mortem, but there is only one paper where collection is done by repeated surgery (Forcada and Lopez, 2000). In our experiment, we used laparotomy and oviduct removal with *in vitro* flushing, leaving the rabbit alive after surgery for use in other experiments. After the first experiment, it was seen that treatment with 21, 28 or 40 mg FSH and 100 IU hCG provided an average response of 20 ovulations per female. This number was twice as much as the non-superovulated rabbits (8 to 10 ovulations). Our observations were similar to Kauffman et al. (1998) who showed the mean ( $\pm$ SD) number of ovulations per female to be  $25.6\pm 15.6$  for a 3 d regimen and  $23.5\pm 8.4$  for 4 d. It was however lower than that seen in our previous observations (Techakumphu, 1987). The difference was believed to come from various factors such as the environment, management system, type of gonadotropin, number of injections, methods of ovulation induction, the mating system, age of donor etc. (Kenelly and Foote, 1965; Techakumphu, 1987; Schmidt et al., 1992; Kauffman et al., 1998). It was noted that the higher concentration of FSH in programs B and C did not improve the number of ovulations but to the contrary resulted in an increased number of non hemorrhagic and hemorrhagic follicles and a lower oocyte recovery rate. Our preliminary study which increased FSH to 48 mg, in four doe rabbits, gave a significantly lower number of oocytes per female with a recovery rate of only 37.7%. Overstimulation tended to reduce the rate of oocyte recovery which was attributed, partially, to the effect of endogenous estrogen production on the oocyte transport and partially to oocytes being trapped in follicles (Kenelly and Foote, 1965). The failure of ova to leave the ruptured follicles was due to being trapped in the follicular lumen or embedded in the granulosa cell of a ruptured follicle. Furthermore, oocyte loss may come from rapid transport through the oviduct after FSH overstimulation, as mentioned by Greenwald (1961). This may explain the low recovery rates in rabbits that received a high dose of FSH. A high variation in ovulation rates was also evident in every group and for both a low or a high dose of FSH. However, most recovered oocytes were matured as seen by the presence of the first polar body, on the surface of oocyte and morphologically suitable for using as a recipient oocyte in our somatic nuclear transfer program (Techakumphu et al., 2001).

The overall recovery rate in Experiment II was 77%, which corresponded to the first experiment. From our observations during enucleation in somatic nuclear transfer, it was noted that the metaphase chromatin location, as related to the polar body, depended on the age of the ovulated oocytes. Using aged oocytes, micromanipulated about 20 hpc (hours post coitus) had a MII less close to polar body, than young oocytes, 15 hpc. For facilitating enucleation, the time of the last FSH injection was adjusted from 16.00 to 19.00 and ovariectomy was changed from 10.00 to 8.00, in order to reduce the age of the micromanipulated oocytes. Since then, more than 80% of ovulated oocytes, possessing MII chromatin adjacent to the polar body were found and enucleation was done more effectively.

Our study showed that the ovulations and number of oocytes were higher in January and February, when there is less effect from heat stress and temperature variations in Thailand. During the summer, the outdoor temperature is more than 37°C and leads to rising indoor temperatures, due to the release of latent heat from the

cement wall. We observed a reduction in both ovulations and oocytes during the summer from March to early April. Wolfenson and Blum (1988) observed a reduction of conception rate of about 15% and the development of the remaining live embryos was retard in heat treated rabbits after fertilization. This indicated that rabbit embryos are susceptible to heat stress during blastocyst formation and during implantation and ovarian function impairment is more pronounced during the rapid linear growth stage of the corpus luteum. Heat stress, different environments and management are involved in such responses.

*In conclusion, the present program of treatments showed, the oocytes at an average of 20 per donor, could be obtained; high variations were noted and the season affected the outcome of superovulation.*

### **References:**

- Forcada, F. and Lopez, M. 2000. Repeated surgical embryo recovery and embryo production in rabbits. *Anim. Reprod. Scie.* 64:121-126.
- Greenwald, G.S. 1961. A study of the transport of ova through the rabbit oviduct. *Fertil. Steril.* 12:80.
- Kauffman, R.D., Schmidt, P.M., Rall, W.F. and Hoeg, J.M. 1998. Superovulation of rabbits with FSH alters *in vivo* development of vitrified morulae. *Theriogenology.* 50:1081-1092.
- Kenelly, J.J. and Foote, R.H. 1965. Superovulatory response of pre- and post-pubertal rabbits to commercially available gonadotropins. *J. Reprod. Ferti.* 9:177-188.
- Schmidt, P.M., Hollifiedl, V.M., Lin, X. and Wildt, D.E. 1992. Induced ovulation and adequate embryo recoveries in New Zealand White rabbits treated with a low PMSG/HCG dose or single, daily injections of FSH-P. *Theriogenology.* 37(1):293. (Abstr.)
- Techakumphu, M. 1986. Superovulation in rabbit. *Thai J. Vet. Med.* 16(4): 272-285.
- Techakumphu, M., Wintenberger, S. and Sevellec, C. 1987. Survival of rabbit embryos after synchronous and asynchronous transfer. *Anim. Reprod. Sci.* 12: 297-304.
- Techakumphu M., Numchaisrika, P., Ahnonkitpanit, V., Suwajanakorn, S., Pruksananonda, B., Boonkasemsanti, W. and Virutamasen, P. 2001. Preliminary study on somatic cell nuclear transfer in rabbit in Thailand. The 16<sup>th</sup> Annual Conference of The Royal Thai College of Obstetrician and Gynaecologist, 16-19 October 2001, p187.
- Tsunoda, Y., Soma, T. and Sugie, T. 1981. Frozen storage of rabbit and hamster embryos. In : *Frozen Storage of Laboratory Animals.* G.H. Zeilmaker (ed), New York, p129-138.
- Willadsen, S.M. 1986. Nuclear transplantation in sheep embryos. *Nature.* 320:63-65.
- Wolfenson, D. and Blum, O. 1988. Embryonic development, conception rate, ovarian function and structure in pregnant rabbits heat-stressed before and during implantation. *Ani. Reprod. Sci.* 17(3-4):259-270.
- Yang, X. 1991. Embryo cloning by nuclear transfer in cattle and rabbits. *Embryo Transfer Newsletter.* 9(4):10-22.



## Chapter 3

### A Technique for Adult and Foetal Fibroblast Cell Culture for Donor Cell Preparation in Somatic Nuclear Transfer

#### *Abstract*

This paper describes the technique of somatic cell culture from adult and foetal tissue in order to use them as nuclear donors in a somatic nuclear program. Biopsies from ear skin and abdominal muscle from adult doe rabbits were used for cell culture and muscle from whole, decapitated foetuses aged 21 days were prepared. Our technique, modified from Vignon et al. (1998), showed that fibroblast cells from skin and muscle of either adults or foetuses could be cultivated and passaged successfully as donor nuclei in nuclear transfer program.

**Key words:** fibroblast cell, adult, foetus, rabbit

#### *Introduction*

In mammals, successful somatic cell cloning has been achieved by using various type of cells collected from prenatal (foetus) and postnatal tissues. Mammary gland cells were first used as donor cells in the first sheep born by SNT (Wilmut et al., 1997). Since then, sertoli cells, oviductal cells, granulosa cells, cumulus cells, uterine cells, white blood cells, liver cells, kidney cells, lung cells, heart cells and fibroblast cells either from adults or foetuses have been studied (Kato et al., 2000). Fibroblast cells are most commonly used as donor cells, because they are easy to obtain, have a high proliferation rate in culture and can be stored frozen. Fibroblast cells can be preserved without any limitations of animal age, sex or physiological state (Dinnyes et al., 2000). They can be prepared from the skin or muscle of adult animals or from the muscle of a foetus. This paper described a technique for the establishment of adult and foetal fibroblast cell lines in rabbits, using nuclear transfer.

#### *Materials and Methods*

##### *Adult fibroblast preparation*

1. Fibroblast cells were collected from biopsied ear-skin or the muscle (rectus abdominis) of an adult female rabbit.
2. The biopsy area was shaved and the surface was cleaned with 70% alcohol.
3. A small piece (0.5 cm in length) of tissue was cut from the ear and washed 3 times in PBS-penicillin+streptomycin solution before being cut into 2-3-mm cubes and placed, fresh side down on the surface of a 35 ml petri dish, to culture as explants. The petri dish was filled with a medium (1 ml DMEM+10% FCS) to cover the explants before they were incubated, without being moved, at 38°C in a 5% CO<sub>2</sub> humidified atmosphere, for 2 days.

4. After 14 days, the fibroblast cells, growing out of these explants, were washed twice with  $\text{Ca}^{2+}$  and  $\text{Mg}^{2+}$  free PBS and then trypsinized with 0.25% trypsin and 0.02% EDTA (Sigma, USA).
5. These primary cells were then washed by centrifugation, resuspended in DMEM+10% FCS in a dilution of 1:3, and cultured with as many as 10 passages, in DMEM, with 10% FCS. The cell passage was performed every 3-4 days when the cells had reached more than 90% confluence. The cells from passage 2 were used as donor cells for nuclear transfer.
6. The remaining of primary cells were stored at  $-80^{\circ}\text{C}$  in DMEM+10%FCS+10% DMSO (Dimethyl sulfoxide, Sigma)
7. Nuclear-donor cells were isolated from starved or non starved cultures drops, supporting a fully confluent cell monolayer, for 5 days before the experiment.
8. Trypsinization: The donor cells from passage>3 were selected, from a confluent cell and later, after adding 0.5, 1.0 and 2.0 ml trypsin-EDTA, incubated in a  $\text{CO}_2$  incubator for 5-10 min, until the cells floated. The cell was washed by centrifugation at 1200 g for 5 min before the precipitate was recovered. The cells were then ready to use as donor cells (Fig. 3.1a to 3.1d)

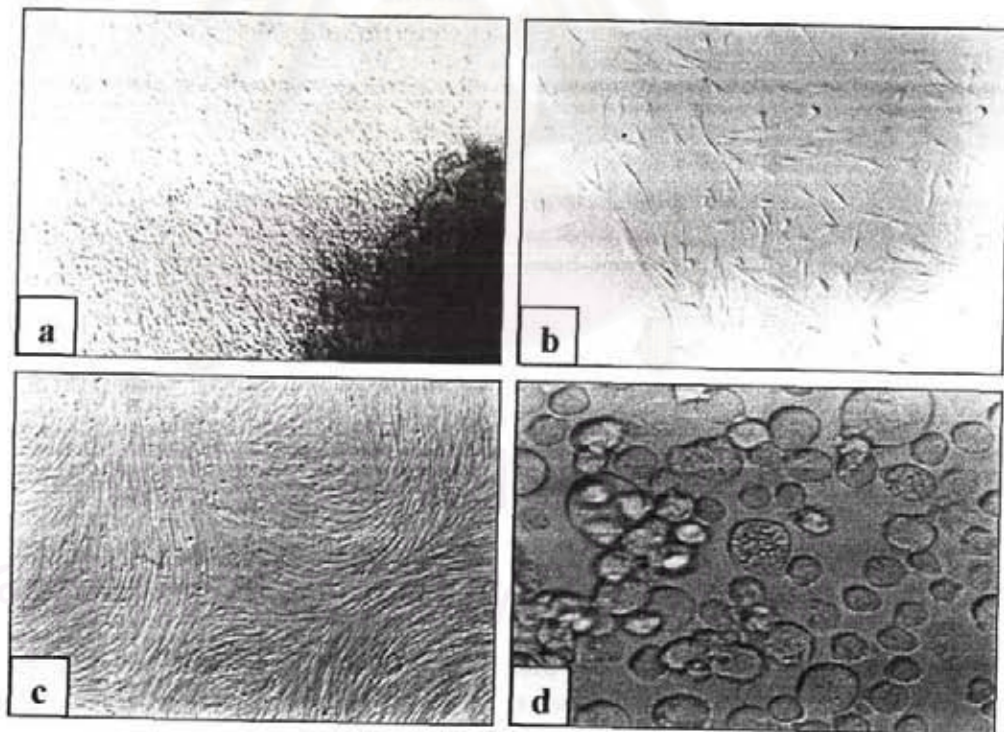

Figure 3.1: Fibroblast cell culture from ear-skin biopsy

- a) fibroblast growing from primary tissue (x100)
- b) a small population of fibroblasts, 7 days after culture (x100)
- c) a full population (confluence) of fibroblasts after passaging (x100)
- d) fibroblast donor cells for somatic cell cloning (x400)

### *Foetal fibroblast preparation*

Foetuses were recovered by caesarian section from 21 day-pregnant does under anesthesia. The foetuses were rinsed in PBS, the head and internal organs were removed and the remaining tissues were prepared by 3 techniques:

- a) by chopping in pieces with a scalpel blade and seeded into a petri dish (Fig. 3.2a or 3.2b)
- b) by cutting into 1-mm cubes (Fig 3.2b)
- c) by placing whole tissue on the petri dish. The tissue was cultured in DMEM+10% FCS. The culture medium was changed every 2 days and after 14 days, the cells were harvested and recultured by passaging. The process of fetal fibroblast preparation was followed from step 4 to 8 as for adult fibroblasts.

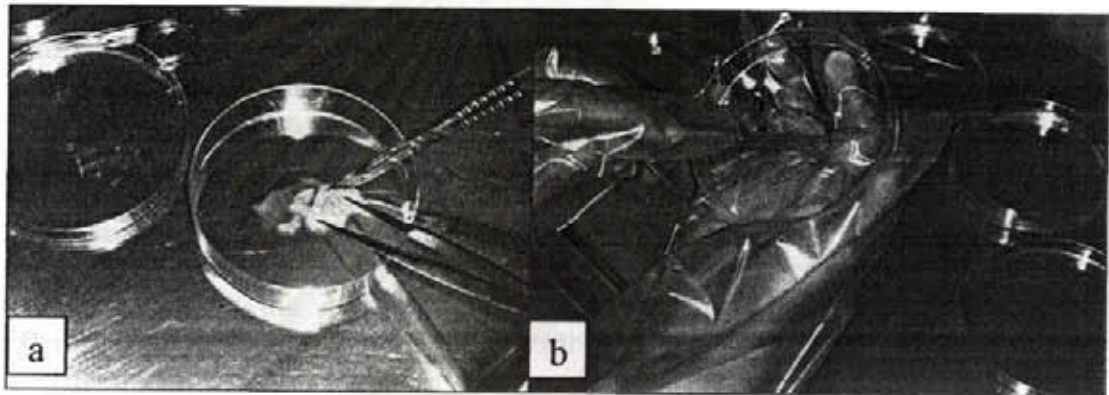

Figure 3.2: The tissue preparation technique

- (a) Tissue chopping technique
- (b) tissue cutting into 1-mm cubes from the rabbit foetus

### *Result and Discussion*

Using the technique of cell culture and preservation, modified from Vignon et al (1998), rabbit fibroblasts cell lines have been established from adult and foetal tissues. It was considered that fibroblasts from adult animals are the cell type, most suitable as nuclear donors, in somatic cloning technologies either for biodiversity conservation or animal breeding (Pennisi and Vogel, 2000). It was remarked that at the beginning of primary cell culture, fat tissue should be removed from the muscle samples, the cartilage and the hair from skin biopsies before being put on to the petri dish. Later, after full growth, the passaging of cells is necessary to maintain the population. Adequate cautions such as the correct culture medium, temperature and proper aseptic techniques should always be used to avoid any contamination. The pH of the medium may indicate the time to refill with fresh medium. A fall of pH from 7.0 to 6.5, turning the colour from pink to orange, will affect cell viability. If the medium changes to yellow, it means that the medium should be immediately removed and replaced. The morphology and the attachment of the cells also indicates cell viability. Healthy fibroblasts should be in spindle form with an extension at both ends (Fig 3.1b, 3.1c). In contrast, when the cells become round, vacuolate or become detached from the

bottom plate, it shows that the cells have degenerated. This may also arise from medium contamination or cell senescence.

It has been suggested that primary cell cultures exhibit a limited number of cell doublings before they reach, a so-called crisis (i.e., senescences), when they cease to divide further, or undergo spontaneous transformation and become "immortal" cell lines (Dinnyes et al., 2001). Cell passage can prevent cell senescence if nutrients are added to them. The cells after passage will divide more rapidly because there is more space and fresh nutrient from the new culture medium. In this study, the cells were passaged every 3 to 4 days until full confluence. It was demonstrated that primary cells from foetuses are capable of undergoing a finite number of population doublings (PDs) in culture before becoming senescence, approximately 30 PDs compared with 20 PDs for fibroblasts obtained from adult animals. Cell lines derived from foetuses differed from those derived from calves and adults in respect of their growth kinetics. At the beginning after plating, foetal fibroblasts grew much faster than calf and adult fibroblasts but later the rate declined more rapidly than that of calf and adult fibroblasts (Kasinathan et al., 2001). Furthermore, the mean cell cycle length, in isolated cells, varied from 9.6 to 15.5 h and was similar to that of embryonic cells, while in population or confluence cultures where the cell cycle length was extended. This means that the cell cycle length is primarily determined by the degree of contact inhibition that takes place between cells. The passaging of cells from confluent cultures results in the immediate resumption of more rapid cell cycles and no differences are observed in cell cycle length between adult and foetal cells. In this experiment, fresh skin samples were used, however tissue preservation can be performed, in the case of valuable specimens, which have died before live skin samples have been obtained. Silvestre et al. (2003) showed that lower in storage temperatures allowed an extension of the time interval between an animal death and successful epithelial tissue collection. At a temperature of 4°C, rabbit and pig skin specimen can be conserved for at least 14 days.

Using this somatic cell culture and preservation technique and from our collaboration project with the Zoological Park Organization of Thailand (ZPO), biopsies from 5 species of endangered feline species were cultivated, fibroblast populations was produced and have been kept in Liquid Nitrogen in the form of primary cells. Furthermore, for agriculture, it would be advantageous to use cells from progeny-tested animals for the multiplication of superior genotypes. Proven sires well adapted to tropical conditions should be kept and preserved. In addition to animals, the endometrium cells from a human patient, submitted by the IVF unit of the Faculty of Medicine; Chulalongkorn University were cultivated, in order to reproduce an endometrial cell population, with the aim of future use in the infertility clinic. Future studies should be focussed on cell cycle manipulation, in order to find the appropriate stage in the cells cycle for cloned embryos to develop properly.

**References:**

- Dinnyes, A., Dai, Y., Barber, M., Liu, L., Xu, J., Zhou, P. and Xiangzhong, Y. 2001. Development of cloned embryos from adult rabbit fibroblasts: Effect of activation and donor cell preparation. *Biol. Reprod.* 64:257-263.
- Kasinathan, P., Knott, J.G., Pedro, Moreira, P.N., Burnside, A.S., Jerry, D.J. and Robl, J.M. 201. Effect of fibroblast donor cell stage and cell cycle on development of bovine nuclear transfer embryos *in vitro*. *Biol. Reprod.* 64:1487-1493.
- Kato, Y., Tani, T. and Tsunoda, Y. 2000. Cloning of calves from various somatic cell types of male and female adult, newborn and fetal cows. *J.Reprod. Fert.* 120:231-237.
- Pennisi, E. and Vogel, G. 2000. Clones: a hard act to follow. *Science*, 288:1722-1727.
- Silvestre, M.A., Saeed, A.M., Cervera, R.P., Escriba, M.J. and Garcia-Ximenez. 2003. Rabbit and pig ear skin sample cryobanking: effects of storage time and temperature of the whole ear extirpated immediately after death. *Theriogenology*. 59:1469-1477.
- Vignon, X., Chesne, P., Le Bourhis, D., Flechon, J.E., Heyman, Y. and Renard, J.P. 1998. Developmental potential of bovine embryos reconstructed from enucleated matured oocytes fused with cultured somatic cells. *Reprod. Biol.* 321:735-745.
- Wilmut, I., Schnieke, A.E., McWhir, J., Kind, A.J. and Campbell. K.H.S.1997. Viable offspring derived from fetal and adult mammalian cells. *Nature*. 385:810-813.

สถาบันวิทยบริการ  
จุฬาลงกรณ์มหาวิทยาลัย

## Chapter 4

### Preliminary Study on Somatic Cell Nuclear Transfer in Rabbits

#### **Abstract**

The objective of the study was to develop a somatic nuclear transfer technique using rabbits as a model. The oocytes recipients, aged 16 h post coitus, were collected surgically from 20 doe rabbits superovulated with 28 and 40 mg Follicle Stimulating Hormone (FSH) after being mated with a vasectomized male. The metaphase II plate and 1<sup>st</sup> polar body of the oocyte was later aspirated using an enucleated micropipette under an inverted microscope. A single donor cell; cumulus cell, cultured or frozen fibroblast cell, from passage 1 to 9, were transferred to the enucleated oocyte and fused with triple DC pulses, 3.2 kv, 20  $\mu$ s. The fused embryos were cultivated in TCM 199NaHCO<sub>3</sub> +10% fetal calf serum for 4 days. The cleavage rate (2 cell stage) was 37.2%(32/86) from eight experiments, and 18.8%(6/32) developed to the early morula stage (>16 cell stage). This study indicated that the enucleation pipette and the somatic cell type influenced the success.

**Key words:** rabbit, fibroblast cells, cumulus cells, nuclear transfer

#### ***Introduction***

Cloning by somatic nuclear transfer is an updated technique for producing multiple numbers of identically genetic animals for breeding purposes and currently it has been recommended for human medical purposes. The production of human therapeutic proteins and xenotransplantation, especially using pig organs for humans. were the objectives for the cloning application in man (Vignon et al., 2000). In this study, the rabbit was selected to be the model for somatic cell cloning, due to its many advantages, such as a high number of oocytes produced per superovulation, a short gestation period, an embryo that develops well in the culture medium and a predictable time of ovulation after mating induction. (induced ovulator) (Yang, 1991). Furthermore, the size of the oocyte is quite similar to the human and other kinds of farm animals. The objective of this study was to develop the technique of somatic cell nuclear transfer.

## ***Materials and Methods***

### *Somatic cell donor preparation:*

The technique of somatic cell donor preparation is presented in Chapter 3. Briefly, skin biopsies from the ear were obtained from a mature New Zealand White doe. The fibroblast cell population was prepared by a technique described by Vignon et al. (1998) and were produced by the subculture of primary cells in DMEM+10% foetal calf serum. After 14 days of culture, the fibroblast cells were trypsinized and later subcultivated. The cultured fibroblast cells at passage 1 to 9 and the fresh cumulus cells recovered after decoronization from matured oocytes. The cells were washed twice by centrifugation in DMEM+10% FCS (Gibco BRL, USA) at 1000g for 10min. The donor cells were kept in DMEM +10% FCS until being transferred to an enucleated oocyte or frozen to  $-196^{\circ}\text{C}$ .

### *Recipient oocyte preparation*

Oocytes were obtained from superovulated rabbit does, as mentioned in Chapter 2.

### *Oocyte enucleation*

The metaphase II and the 1<sup>st</sup> polar body were removed in a microdrop of TCM199  $\text{NaHCO}_3$  +  $7\mu\text{g}\cdot\text{ml}^{-1}$  cytochalasin B (Sigma, USA), using an inverted microscope, as described by Heyman et al. (1990) and Chesne et al. (2000). The success of metaphase II removal was identified by showing it under fluorescing after using  $5\mu\text{M}$  Hoechst #33342 (Sigma, USA).

### *Somatic cell transfer*

Nuclear transfer was performed by a technique described by Heyman et al. (1990) and Chesne et al. (2001). Each isolated cell (cumulus or fibroblast cell) was inserted under the zona pellucida of the oocyte recipient (fig. 3) and later fused by electrostimulation (Grass stimulator, Astro-Med, INC. USA),  $3.2\text{ kV/cm}$   $20\ \mu\text{sec}$  3 pulses in  $0.3\text{ M}$  mannitol solution containing  $0.1\text{ mM}$   $\text{Ca}^{++}$  and  $\text{Mg}^{++}$ . Each fused embryo was placed in a small drop of TCM 199  $\text{NaHCO}_3$  +10% FCS under mineral oil, for 4 days at  $37^{\circ}\text{C}$  and 5%  $\text{CO}_2$  in air. Cleavage was assessed every 24 h using a binocular microscope.

The process of somatic cell nuclear transfer is described in Fig. 4.1.

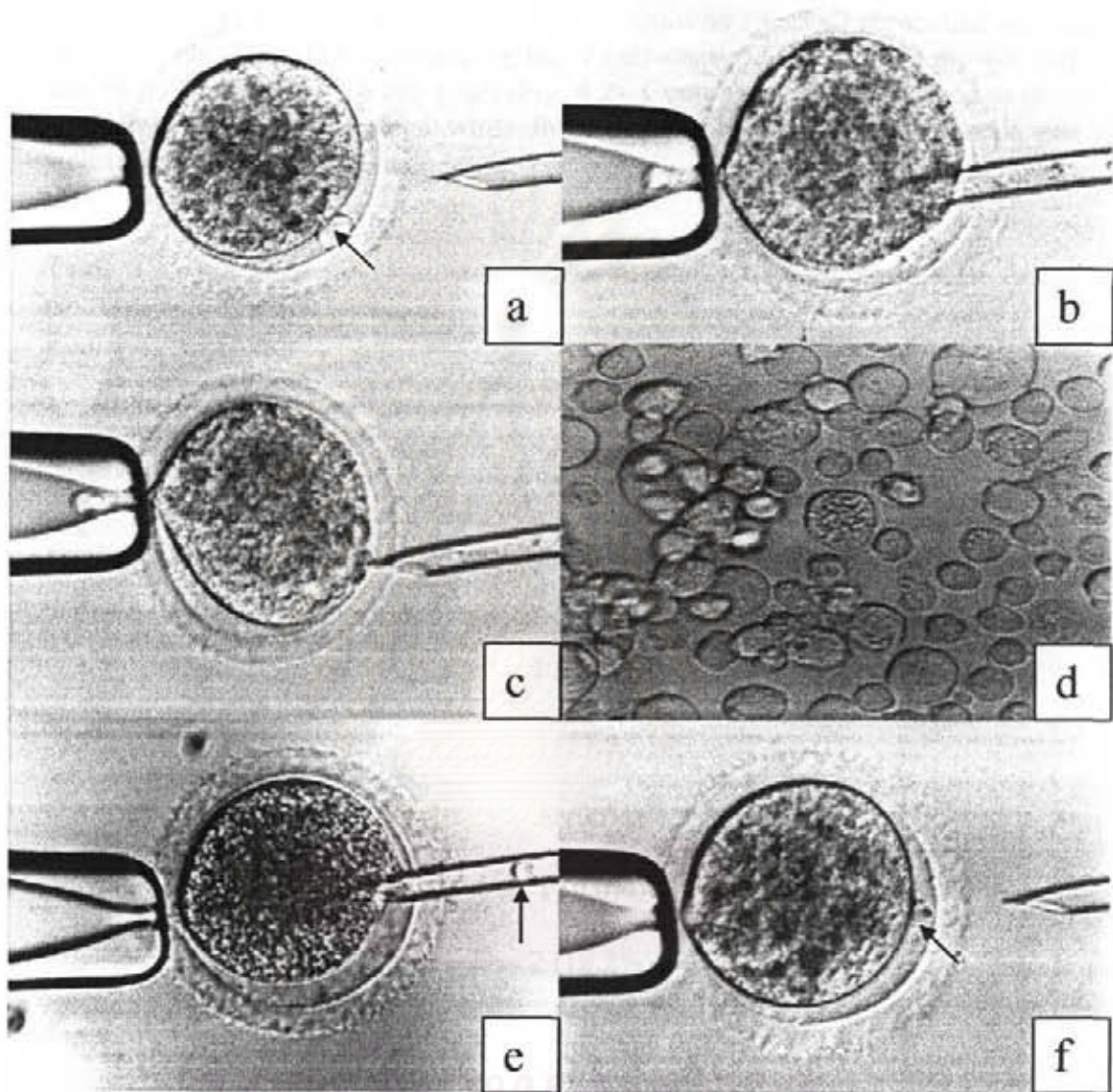

Figure 4.1: The process of somatic cell cloning in rabbits (x300)

a: A matured oocyte with a 1<sup>st</sup> polar body on the surface of the cytoplasm (arrow). The oocyte was maintained by a holding pipette, with an internal diameter (ID) of 20µm, and the polar body was placed between 4 to 5 o'clock. Facing the beveled pipette (BP) of 20 µm ID

b: The BP was penetrated, through the zona pellucida into the cytoplasm of the oocyte, above the polar body. The surrounding cytoplasm, around 15-20%, was aspirated by delicate, slow aspiration.

c: The BP was later pulled back after enucleation had occurred

d: A group of fibroblast cells as donor cells.

e: The single fibroblast cell (arrow) was aspirated into the BP and its tip penetrated through the same enucleation opening

f: The donor cell (arrow) was expelled into the oocyte under the zona pellucida and attached to the cytoplasm



## Result

The results in Table 4.1 showed that 32 from 86 (37.2%) reconstructed embryos cleaved with 43.8% (14/32) reaching the 2 cell stage, 37.5% (12/32) the 4-8 cell stage and 18.8% (6/32) the  $\geq 16$  cell stage (Fig. 4.2). Cumulus cells can be used as donor cell providing 69.2% of cleavage while frozen and cultivated fibroblast cells can give a cleavage ranging from 9% to 90%.

Table 4.1. *In vitro* development of reconstructed rabbit embryos after fusion with cumulus and fibroblast cells

EXP	Donor cell type	No. oocytes	Cleaved embryos (%)	Stage of embryo		
				2 cell	4-8 cell	$\geq 16$ cell
1	Frozen fibroblast	5	4 (80%)		4	-
2	Frozen fibroblast	19	3 (29.2%)	1	2	-
3	Cumulus cell	13	9 (69.2%)	5	4	-
4	Fibroblast cell (P1)	6	1 (16.7%)	1	-	-
5	Fibroblast cell(P3)	11	3 (27.2%)	2	1	-
6	Fibroblast cell(P4)	10	9 (90%)	4	1	4
7	Fibroblast cell (P6)	11	1 (9.0%)			1
8	Fibroblast cell(P9)	11	2 (18.2%)	1		1
Total		86	32 (37.2%)	14(43.8 %)	12 (37.5%)	6 (18.8%)

(P)= passage

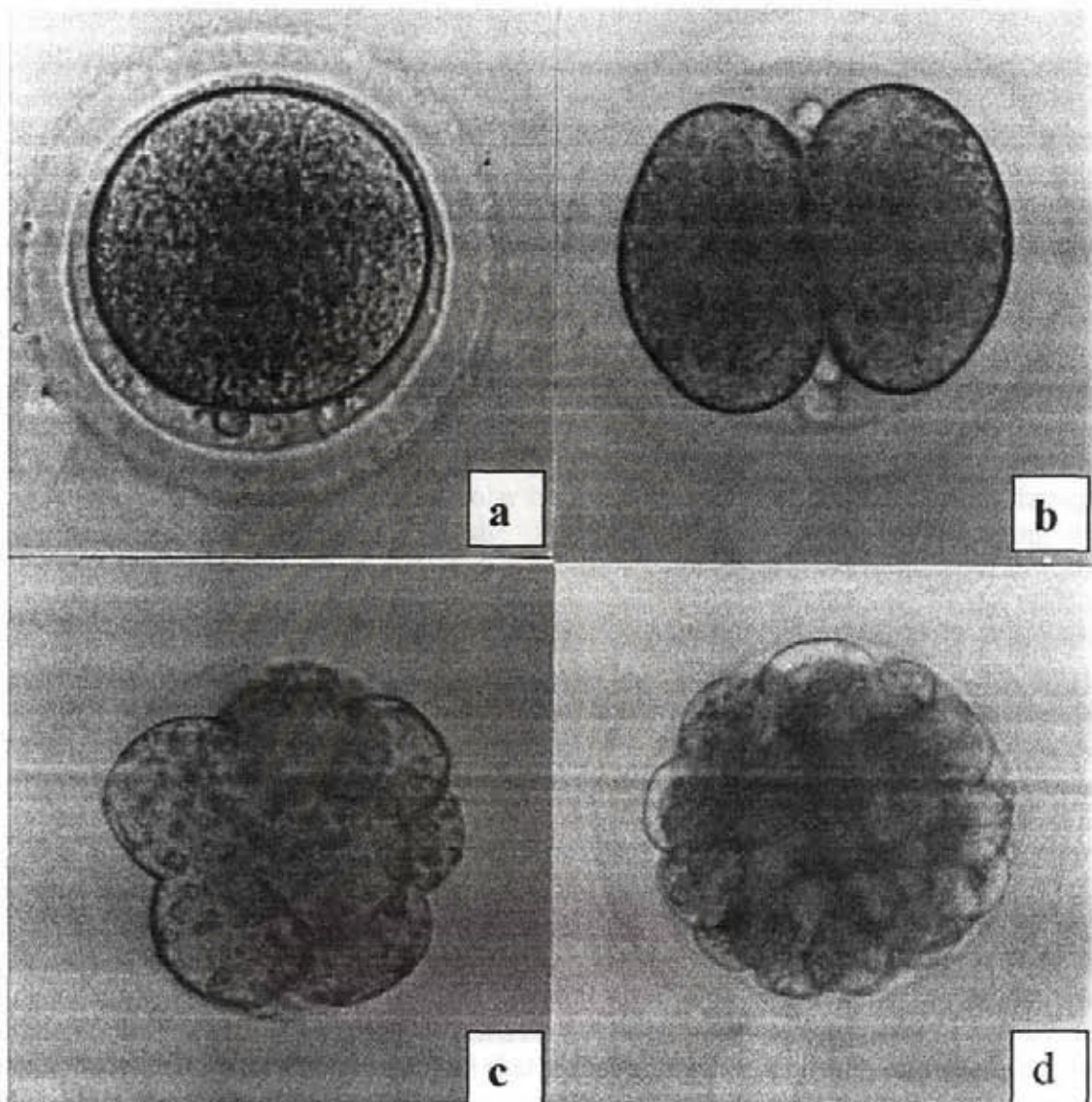

Figure 4.2: A cloned rabbit embryo after somatic cell nuclear transfer  
a: A reconstructed embryo with a fibroblastic cell on the surface (X400)  
b: A two-cell stage embryo (X400)  
c: An eight-cell stage embryo (X400)  
d: A early morula stage (>16 cell) (X400)

### *Discussion*

This paper describes the technique of somatic cell nuclear transfer using rabbit oocytes and fibroblasts as a model. Every processes influenced the success of embryo reconstruction and *in vitro* development. The essential steps and factors for somatic cell nuclear transfer are discussed. *Firstly*, the microtool preparation; the sharpness, cleanliness, angle and diameter (about 20  $\mu\text{m}$  ID) of enucleating pipette, including the spike at the end of pipette, facilitated the enucleation. Delicate control during somatic cell aspiration and transfer into the oocyte was also required. Donor cell aspiration by the pipette should be done before enucleation. The holding pipette was also important, especially its diameter, which should not be wider than 20  $\mu\text{m}$ . *Secondly*, the quality of the cytoplasm of the oocyte recipient. *Thirdly*, the location of the 1<sup>st</sup> polar body, should be between 4 to 5 o'clock, which helps to simplify enucleation. It was suggested that the tip of the beveled pipette should be pinched through the zona pellucida at the same level as the polar body before enucleation. Penetration through the zona pellucida should be at the 3 o'clock position and after removing the surrounding cytoplasm (Fig. 4.1B), the pipette should be pressed downward towards the polar body, before aspiration. In some oocytes, a loose polar body, on the surface of an oocyte can occur and make polar body removal fail. The amount of enucleated cytoplasm should not be excessive, in order to have better contact between the oocyte and the donor cell. *Fourthly*, the selection of donor cells was a prerequisite to success, a medium size with a clear, shiny cytoplasm should be selected. In this study, fibroblasts, both frozen and cultivated, were used as donor cells, as well cumulus cells. It was demonstrated that fibroblast cells in the form of cultivated or frozen, as well as cumulus cells, can be used as nuclear donors which accords with Chesne *et al* (2001).

Furthermore, incubation in cytochalasin B, the depolymerizing product, was beneficial for enucleation, by preventing cytoplasm lysis. The incubation time in cytochalasin B was 30 mins before enucleation. The success of the study was determined by cleavage to the 2 cell and 8-16 cell stage during *in vitro* culture. In conclusion, this study demonstrated that fibroblast cells, cultured or frozen can be used in a somatic cell nuclear transfer program.

สถาบันวิทยบริการ  
จุฬาลงกรณ์มหาวิทยาลัย

### References

- Heyman, Y., Chesne, P. and Renard, JP. 1990. Reprogrammation complete de noyaux embryonnaires congelés, après transfert nucléaire chez la lapin. C.R. Acad. Sci. Paris, t. 311, Serie III, p321-326.
- Chesne, P., Vignon, X., Heyman, Y., Adenot, P. and Renard, J.P. 2000. Methods for cloning in domestic mammals. The Workshop in Application of Somatic Cell Cloning for Medical Research. August 8-10, 2000, Fac. Medicine, Chulalongkorn Univ. p19-34.
- Chesne, P., Adenot, PG., Boulanger, L. and Renard, JP. 2001. Somatic nuclear transfer in rabbit. Theriogenology. 55(1):260 (Abstr.)
- Techakumphu, M. 1986. Superovulation in rabbit. Thai J. Vet. Med. 16(4): 272-285.
- Vignon, X., Chesne, P., Le Bourhis, D., Flechon, J.E., Heyman, Y. and Renard, J.P. 1998. Developmental potential of bovine embryos reconstructed from enucleated matured oocytes fused with cultured somatic cells. Reprod. Biol. 321:735-745.
- Vignon X., Chesne P., Heyman Y. and Renard J.P. 2000. The somatic cloning in mammals: present situation and applications. The Workshop in Application of Somatic Cell Cloning for Medical Research. August 8-10, 2000, Fac. Medicine, Chulalongkorn Univ. p47-61.
- Yang, X. 1991. Embryo cloning by nuclear transfer in cattle and rabbits. Embryo Transfer Newsletter. 9(4):10-22

สถาบันวิทยบริการ  
จุฬาลงกรณ์มหาวิทยาลัย

## Chapter 5

### *In vitro* Development of Cloned Rabbit Embryos from Adult Fibroblast Cells after Post-activation Treatment with Cyclohexamide and 6-Dimethylaminopurine

#### Abstract

The objective of the study was to improve the technique of somatic cell nuclear transfer by using double electrical activation and post-activation with two drugs; cyclohexamide (CHX; a protein synthesis inhibitor) and 6-Dimethylaminopurine (6-DMAP, a kinase inhibitor) after oocyte reconstruction. The metaphase II and 1<sup>st</sup> polar body of the oocyte was aspirated using an enucleating micropipette under an inverted microscope. Cultivated fibroblast cells from passage 9 to 15 were transferred to the enucleated oocyte. Reconstructed oocytes were later activated by two sets of electrical stimulation, 1 h apart, (3 DC pulses of 1.2 Kv.cm<sup>-1</sup> for 20 μsec each in Mannitol 0.3 M). After the second set of electrostimulation they were incubated in Cyclohexamide 5 μg.ml<sup>-1</sup> and 6-DMAP 2 mM in M199 for 1 h then washed and cultured in M199, supplemented with 10% FCS. The cleavage, morula and blastocyst rates were recorded every 24 h for 7 days. The study showed that the cleavage rate was 68.6%(109/159) and the morula/blastocyst rate was 28.9% (46/159). It can be concluded that cloned morula and blastocysts can be obtained using this protocol.

**Key words:** rabbit, nuclear transfer, fibroblast cell

#### Introduction

Oocyte activation is one the key factors that determines the success of somatic nuclear transfer. Optimized activation of the recipient cytoplasm enhances better reprogramming of the reconstructed embryo, which leads to successful rabbit cloning. Electrostimulation or incubation with a single activation chemical, such as ionophore or ethanol, has been used to activate reconstructed oocytes (Ozil, 1990; Lui et al., 2002). Recently a report on rabbits by Chesne and collaborators (2001), showed that the combination of two sets of electrostimulation, together with the protein synthetic inhibitor cyclohexamide and the protein kinase inhibitor, 6-Dimethylaminopurine (6-DMAP), provided a high number of blastocysts after somatic nuclear transfer. The same observation was made by Dinnyes et al. (2000) and Lui et al. (2002). Our preliminary researches in chapters 2 and 4, showed that oocyte recipients could be produced with satisfactory results and cloned rabbit embryos, using frozen-thawed, cultivated fibroblast and cumulus cells, as donor cells, cleaved and developed beyond 16 cells. However, low cleavage rates with a high variation of cloned embryo development were observed. The objective of the study was to improve the

development of cloned embryos by using double electrical activation and post-activation, by using two drugs; cyclohexamide and 6-DMAP, after oocyte reconstruction.

### **Materials and Methods**

#### *Preparation of donor cells and Preparation of recipient oocytes*

The fibroblast cells from passage 9 to 15 and the oocytes used in this experiment were prepared as described in previous chapters.

#### *Reconstruction by Somatic Nuclear Transfer*

The genetic material removal, "enucleation", was performed under an inverted microscope. The 1<sup>st</sup> polar body and about 20% of the surrounding cytoplasm was removed in a small drop of TCM199+Hepes+ 7 $\mu$ g.ml<sup>-1</sup> cytochalasin-B. Single donor cells were introduced into the perivitelline space of the enucleated oocytes by the technique described in previous chapters. Later, the oocyte-donor cell complexes (ODC) were manually placed in a 5.5-mm gap chamber of Grass stimulator (USA), in 0.3 M mannitol solution, containing 0.1 mM calcium chloride and 0.1 mM magnesium chloride, then exposed with 3 short, 2- to 3- sec AC pulses of 3.2 kV/cm 20 $\mu$ s, to enable fusion. The ODC were cultivated for 1 h in TCM 199+10% FCS, at 37 °C, in 5% CO<sub>2</sub>. The fused embryos were activated by electric current as above and were then incubated in Cyclohexamide 5  $\mu$ g ml<sup>-1</sup> and 6-DMAP 2 mM (Sigma, USA), in M199+10% FCS for 1h (Chesne et al.,2001, then washed and cultured in a small drop of TCM199+10% FCS, under mineral oil, at 37°C, in 5% CO<sub>2</sub>. The *in vitro* development was assessed every 24h under a microscope. The cleavage, morula and blastocyst formation rates were calculated, based on the number of reconstructed embryos.

### **Results**

Table 5.1 shows the results of *in vitro* development of rabbit cloned embryos by using donor cells, from passage 9 to 15. The cleavage rate varied from 58.7% to 83.3% and the morula/blastocyst formation rate was 15.2% to 51.7% with an average of 28.9% (46/159) (Fig. 5.1).

Table 5.1: *In vitro* development of cloned rabbit embryos

No. passages	No. reconstructed embryos	No. cleaved embryos (%)	No. morula/blastocysts (%)
9	12	10 (83.3%)	0
10	29	18(62.1%)	15(51.7%)
11	27	22(80.9%)	6(22.2%)
12	46	27(58.7%)	7(15.2%)
13-15	45	32(71.1%)	12 (28.9%)
<b>total</b>	<b>159</b>	<b>109(68.6%)</b>	<b>46(28.9%)</b>

% morula and blastocysts calculated from the number of reconstructed embryos

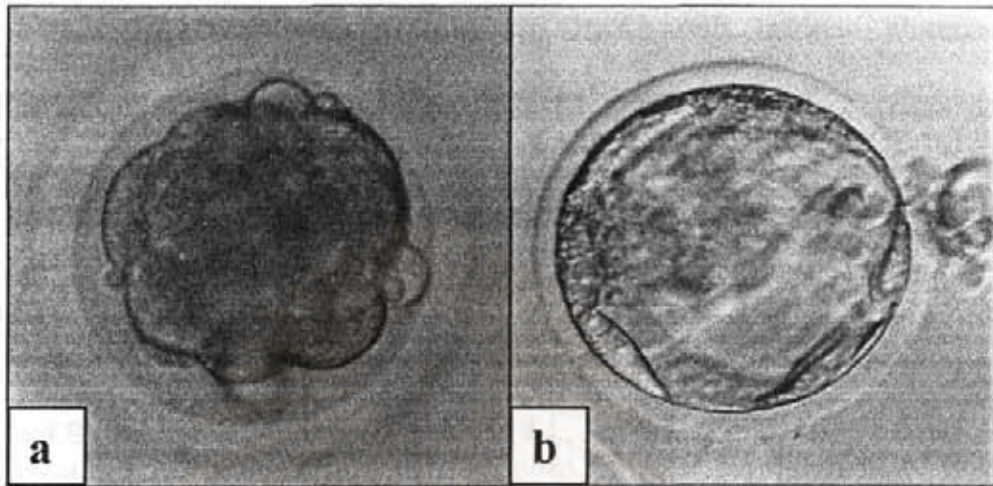

Figure 5.1: Cloned morula (a) and blastocyst (b) after using an adult rabbit fibroblast cell as the donor cell. (X400)

#### Discussion

Before April 2002 there were no offspring from cloned rabbits using somatic nuclear transfer. The first successful report was by Chesne et al. (2002). This permitted its use in biopharmaceutical, as a method for large-scale production of foreign proteins (Chesne et al., 2002). Our previous study in Chapter 4, using the techniques of Chesne et al. (2000) and Vignon et al. (2000), found it possible to successfully perform *in vitro* development of cloned rabbit embryos, after fibroblast and cumulus cell transfer, although with limited success. The cleavage rate (2-cell stage) was 37.2%(32/86) out of which 18.8%(6/32) developed to an early morula stage (>16 cell). The application of double electrical activation and post-activation, using the two drugs cyclohexamide (CHX) and 6-DMAP facilitating the exit of the artificially activated MII stage, seemed to provide a higher *in vitro* development rate, than in our previous results. The cleavage rate was 70% and development to the morula-blastocyst stage rate was 30%, with some hatched blastocysts found after 7 days of culture. Cyclohexamide was used to maintain a low level of Maturation Promoting Factor (MPF) activity, which was normally at a high level in mature oocytes. It was suggested however that 6-DMAP treatment might affect the reprogramming process of the donor nuclear material in nuclear transfer. The combination of electrical and 6-DMAP treatment for the activation of recipient cytoplasm has been used in cattle nuclear transfer (Cibelli et al., 1998). In rabbits, Dinnyes et al. (2000) found that activation of cloned rabbit embryos, by one or two electrical pulses resulted in significant lower blastocyst development (0% and 8% respectively) than one electrical pulse, followed by 1- or 2-h exposure to DMAP. The blastocyst rate can be increased from 23 to 29% by the later treatment. A similar DMAP effect was observed by Liu et al. (2002) who showed that the blastocyst formation and cleavage rates were greater in parthenote oocytes, when submitted to a combination of single activation agents, either calcium ionophore A23187, thimerosal

or ethanol with DMAP. It means that the DMAP treatment can be an efficient component in activation procedures in rabbits, as is found in cattle (Dinnyes et al., 2000). However, long term exposure to DMAP will lead to chromosomal abnormalities in cloned embryos.

### **References:**

- Chesne, P., Adenot, P.G., Boulanger, L. and Renard, J.P. 2001. Somatic nuclear transfer in rabbit. *Theriogenology*. 55(1):260 (Abstr.)
- Chesne, P., Adenot, P.G., Viglietta, C., Baratte, M., Boulanger, L. and Renard, J.P. 2002. Clone rabbits produced by nuclear transfer from adult somatic cells. *Nature biotechnology*. 20:366-369.
- Cibelli, J.B., Stice, S.L., Golueke, P.J. Kane, J.J., Jerry, J., Blackwell, C., Ponce, de Leon, F.A. and Robl, J.M. 1998. Cloned transgenic calves produced from non quiescent fetal fibroblast. *Science*. 280:1256-1258.
- Dinnyes, A., Dai, Y., Barber, M., Liu, L., Xu, J., Zhou, P. and Xiangzhong, Y. 2001. Development of cloned embryos from adult rabbit fibroblasts: Effect of activation and donor cell preparation. *Biol. Reprod.* 64:257-263.
- Liu, C.T., Chen, C.H., Cheng, S.P. and Ju, J.C. 2002. Parthenogenesis of rabbit oocytes activated by different stimuli. *Anim. Reprod. Sci.* 70:267-276.
- Ozil, J.P. 1990. The parthenogenetic development of rabbit oocytes after repetitive pulsatile electrical stimulation. *Development*. 109:117-128.
- Vignon, X., Chesne, P., Le Bourhis, D., Flechon, J.E., Heyman, Y. and Renard, J.P. 1998. Developmental potential of bovine embryos reconstructed from enucleated matured oocytes fused with cultured somatic cells. *Reprod. Biol.* 321:735-745.
- Vignon X., Chesne P., Heyman Y. and Renard J.P. 2000. The somatic cloning in mammals: present situation and applications. *The Workshop in Application of Somatic Cell Cloning for Medical Research*. August 8-10, 2000, Fac. Medicine, Chulalongkorn Univ. p47-61.
- Wolf, E., Zakhartchenko, V and Brem, G. 1998. Nuclear transfer in mammals: Recent developments and future perspectives. *J. Biotech.* 65:99-110.



## Chapter 6

### Development of Cloned Rabbit Embryos Using Cumulus Cells, Serum-Starved and Non-Starved Fibroblast Cells as The Donor Nucleus

#### Abstract

This research was designed to study the *in vitro* development of cloned rabbit embryos using cumulus cells (EXP I) and muscular fibroblast cells (EXP II) as the differentiated donor nucleus. The effect of serum starvation on donor fibroblast cells on cloning success was examined. Cell starvation was performed by cultivation in DMEM culture medium, supplemented with 0.5% foetal calf serum for 5 days. A total of 311 ovulated oocytes, obtained from FSH-superovulated doe rabbits were enucleated under a microscope and later fused-activated after donor nuclear insertion. The technique of enucleation, fusion and activation the same as in our previous studies. After fusion-activation, the reconstructed embryos were cultivated in B2 medium for 7 days, under 5% CO<sub>2</sub>, in air, at 38.5°C. The *in vitro* development was observed and recorded every 24 h. In EXP I, the cleavage of cloned embryos was 71.8% (74/103) and the blastocyst rate was 15.5% (16/103). In EXP II, there was no difference ( $P>0.05$ ) in the development rates between starved and non starved groups. The blastocyst rates of each group were 25.0% (21/84) in starved group and 28.6%(20/70) in non starved groups, respectively. It can be concluded that cumulus cells and muscular fibroblast cells can be used as donor nuclear cells in rabbit cloning and there was no effect from serum starvation on the donor nucleus for the *in vitro* development of cloned embryos.

**Keywords:** rabbit, fibroblast cells, cumulus cells, nuclear transfer

#### Introduction

Nowadays, there has been much progress in nuclear transfer by using either totipotent differentiated donor cells, since the discoveries of Wilmut and collaborators (1997). In our previous work, we reported on the *in vitro* development of cloned rabbit embryos using frozen-thawed or fresh fibroblast cells from skin biopsy and fresh cumulus cells, however the results showed limited success (Techakumphu *et al.*, 2001). Since modifying fusion and activation protocol has been applied, as described previously (Chesne *et al.*, 2001), the *in vitro* development of cloned embryos has improved as described in Chapter 5. It was found that the type and stage of cell cycle of donor cells, influenced the efficiency of nuclear transfer (Stice *et al.*, 1993) and serum starvation can induce the presumed G<sub>0</sub> stage (Wilmut *et al.* 1997). The result from G<sub>0</sub> stage donor nuclei provided a higher result in somatic cell cloning than other stage. From this knowledge, this experimental work was designed to study the *in vitro*

development of cloned rabbit embryos, by using cumulus cells (EXP I) and cultured muscular fibroblast cells, in serum-starved and non-starved conditions (EXP II).

### **Materials and Methods**

#### *Preparation of donor cells*

The donor cells came from cumulus cells and fibroblast cells. The cell preparation followed the procedures described below:

##### *a) Cumulus cell isolation (EXP I)*

Fresh cumulus cells from the mature oocyte were recovered at the same time as the oocyte recovery. The cells were dissociated mechanically by pipetting in TCM 199 for several times and preserved until used.

##### *b) Primary cell culture of fibroblast cells (EXP II)*

The fibroblast cells were obtained from biopsy of muscle and prepared as described in Chapter 3. The fibroblast cells from passage 2-5 were used as donor nuclear cells. The cell starvation was performed by culture in TCM 199+0.5% foetal calf serum for 5 days before usage.

#### *Preparation of recipient oocytes*

The ovulated mature oocytes recovered from mature New Zealand White doe rabbits after superovulation were used as recipient oocytes as described in Chapter 2. The oocytes were incubated in TCM-199 (Sigma, USA) supplemented with 0.1% Hyalurodinase for 15 min. in 5% CO<sub>2</sub> at 38.5°C. The cumulus cells were removed and oocytes were later incubated in TCM-199+ 2.5 M HEPES, with 7 µg/ml cytochalasin-B for 30 min. Each oocyte was then enucleated by micromanipulation under an inverted microscope. The technique of enucleation was as previously described in Chapter 4.

#### *Reconstruction by somatic nuclear transfer*

An isolated cumulus cell or a fibroblast cell was inserted inside the zona pellucida (Fig. 6.1), next to the surface of the ooplasm of the recipient oocyte and subsequently fused by electrostimulation (Grass stimulator, USA), with 3.2 kV/cm 20µs 3 pulses in 0.3 M mannitol solution and 0.1 mM Ca<sup>++</sup> and Mg<sup>++</sup>. After 1 h activation, fused embryos were activated by an electric current using the same pulse. The oocytes were immediately incubated in 5 µg/ml cyclohexamide and 2mM 6-DMAP (Sigma USA), dissolved in TCM199+10% FCS for 1 h (Chesne *et al.*,2001), then washed and cultured in a small drop of B2 medium (Menezo, France), covered with mineral oil, at 38.5°C, in 5% CO<sub>2</sub> in air. The *in vitro* development was assessed every 24 h under a microscope. The cleavage, morula and blastocyst formation rates were calculated based on the number of reconstructed embryos. The starved and non-starved groups were compared by using Chi-square analysis.

### **Result**

Fused and cultivated embryos were seen from 73.5% cumulus cells, 91.3% for starved fibroblast cells and 88.6% non-starved fibroblast cells. For cumulus cells, the cleavage rate was 71.8% and the rate of 4 cells, 8-16 cells, morula and blastocyst formation were 11.7%, 7.8%, 35.0% and 15.5% respectively. The development of cloned embryos when compared between starved and non-starved groups, was not

significantly different for either the cleavage and the development rate of each category. The blastocyst rates were 25.%(21/84) and 28.6%(20/70) in starved and non starved groups respectively (Table 6.1, Fig. 6.2).

Table 6.1: The *in vitro* development of cloned rabbit embryos using cumulus cells, serum-starved and non-starved fibroblast cells, as the donor nucleus

EXP	Type of cell	Replicates	Reconstructed oocytes	Fused-Cultivated Embryos (%)	Cleavage (%)	4 cell (%)	8-16 cell (%)	Morula (%)	Blastocyst (%)
I	CUMU	12	140	103	74	12	8	36	16
	LUS			(73.5)	(71.8)	(11.7)	(7.8)	(35.0)	(15.5)
II	SFB	10	92	84	74	14	8	31	21
	NSFB			(91.3)	(88.1)	(16.6)	(9.5)	(36.9)	(25.0)
	NSFB	9	79	70	58	8	7	22	20
				(88.6)	(82.9)	(11.4)	(10.0)	(31.4)	(28.6)

SFB = serum-starved fibroblast, NSFB = non-starved fibroblast

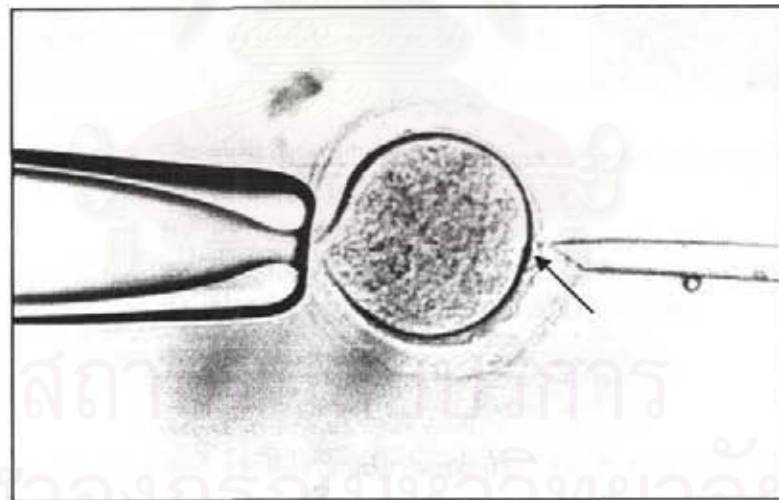

Figure 6.1: A fibroblast cell (arrow) being transferred to an enucleated oocyte (x300)

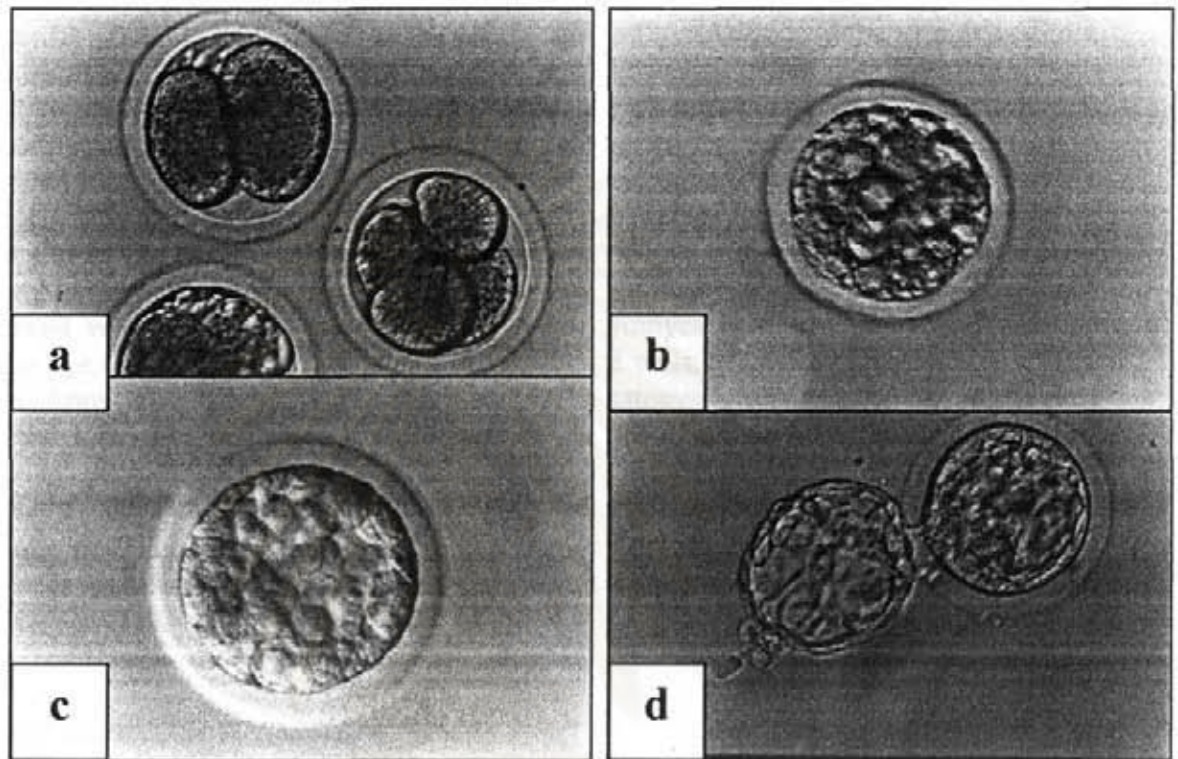

Figure 6.2: Cloned embryos at different stages

- a) 2–4 cell stage (x300)
- b) morula stage (x300)
- c) Blastocyst (x 300)
- d) Hatched blastocyst from SNT (x200)

### Discussion

The results obtained in this study were 10-15% better than the cleavage and morula rates, seen in Chapters 4 and 5. It was remarkable that the hatched blastocyst rate could be increased from 3% in Chapter 5 to approximately 15% in EXP I and 30% in EXP II. Hatched blastocysts were obtained in almost every replication. The result was comparable to other reports (Dinnyes *et al.*, 2001; Li *et al.*, 2002) but lower than that from Chesne *et al.* (2001). Improvement came from two factors, the first was the duration of enucleation and donor nuclei transfer, which was around 3-5 min. for each oocyte. It has been recommended that a faster process could provide a higher cloned embryonic development (Chesne, 2002; personal communication). The second factor was the culture condition; culture medium and culture temperature. In this experiment, a B2 complex medium was used instead of TCM 199+10% foetal calf serum, and the temperature, being changed from 37°C to 38.5°C which have been used effectively for embryo culture in manipulated rabbit embryos (Techakumphu *et al.*, 1987)

In our study, it was demonstrated that cumulus cells and cultivated fibroblast were totipotent and could be used as donor cells. This finding was in agreement with reports in the literature (Dinnyes *et al.*, 2001; Chesne *et al.*, 2000, 2001; Kühholzer *et al.*, 2001). It was remarked that the size of the cumulus cells was small, around 50% of the size of fibroblast cells and this may cause a poorer fusion rate, compared to that from fibroblast cells. The fibroblast cells were easily obtained by the primary culture of biopsied muscle. From our experience, muscle biopsy provided a better fibroblast cell outgrowth from the explant, approximately 2 weeks after seeding and higher multiplication, than skin biopsy. It has been suggested that serum starvation can assist the cell into entering G0 stage of the cycle and these cells provide a higher success rate for somatic cell cloning when correct and complete reprogramming is done, after transfer to the oocyte cytoplasm (Wilmut *et al.*, 1997). From our results, the *in vitro* development of cloned embryos showed no significant difference between non-starved versus serum-starved fibroblast cells. Dinnyes *et al.* (2001) found that the cleavage rate of embryos produced from starved cells, was significantly higher than that from non-starved cells, however, the blastocyst rate showed no difference between the two treatments. Kühholzer *et al.* (2001) found that the use of serum-starved cells (G0) showed no positive effect on the development of cloned embryos *in vitro*, when compared to cycling cells. It can be concluded that cumulus cells and muscular fibroblast cells can be used as donor nuclear cells for rabbit cloning and there is no effect of serum starvation on the donor nucleus on the *in vitro* development of cloned embryos.

### References

- Chesne P., Adenot, P.G., Boulanger, L. and Renard. J.P. 2001. Somatic cell nuclear transfer in rabbit. *Theriogenology*. 55(1):260(Abstr.).
- Chesne, P. 2002 (personal communication).
- Dinnyes, A., Dai, Y., Barber, M., Liu, L., Xu, J., Zhou, P. and Yang. X. 2001. Development of cloned embryos from adult rabbit fibroblasts: Effect of activation treatment and donor cell preparation. *Biol. Reprod.* 64: 257-263.
- Kühholzer, B., Hawley, R. J., Lai, L., Kolber-Simonds, D. and Prather, R.S. 2001. Clonal lines of transgenic fibroblast cells derived from the same fetal result in different development when used for nuclear transfer in pigs. *Biol. Reprod.* 64:1695-1698.
- Li, G.P., Chen, D.Y., Lian, L., Han, Z.M., Zhu, Z.Y. and Seidel, G.E. 2002. Rabbit cloning: Improved fusion using cytochalasin B in the fusion buffer. *Mol. Reprod. Dev.* 61:187-191.
- Stice, S.L., Keefer, C.L., Maki-Laurila, M. and Matthews, L. 1993. Donor blastomere cell cycle stage affects developmental competence of bovine nuclear transfer embryos. *Theriogenology*. 39:318. (Abstr.)
- Techakumphu, M. Wintenberger,-Torres, S., Sevellec, C. and Menezo, Y. 1987. Survival of rabbit embryos after culture or culture/freezing *Anim. Reprod. Sci.* 13:208-221.

- Techakumphu M., Numchaisrika, P., Ahnonkitpanit, V., Suwajanakorn, S., Pruksananonda, K., Boonkasemsanti, W. and Virutamasen, P. 2001. Preliminary study on somatic cell nuclear transfer in rabbit in Thailand. The 16<sup>th</sup> Annual Conference of The Thai Royal Obstreticians and Gynaecologists, 16-19 October, 2001, p187.
- Vignon, X., Chesne, P., Le Bourhis, D., Flechon, J.E., Heyman, Y. and Renard, J.P. 1998. Developmental potential of bovine embryos reconstructed from enucleated matured oocytes fused with cultured somatic cells. *Reprod. Biol.* 321:735-745.
- Wilmot, I., A.E. Schnieke, J. McWhir, A.J. Kind, and K.H.S. Campbell.1997. Viable offspring derived from fetal and adult mammalian cells. *Nature.* 385:810-813.



สถาบันวิทยบริการ  
จุฬาลงกรณ์มหาวิทยาลัย

## Chapter 7

### Development of Cloned Embryos from Adult and Foetal Rabbit Fibroblast Cells

#### *Abstract*

The objective of the study was to investigate the *in vitro* development of cloned rabbit embryos using adult and foetal fibroblasts as donor cells. A total of 473 matured oocytes obtained by superovulation were used as the recipient cytoplasm. The oocytes were subjected to epifluorescent staining, with 5 $\mu$ M Hoechst 33342 for 15 min, to visualize the metaphase chromatin. All processes followed our previous studies. It was found that a higher development rate was found in cloned rabbit embryos using adult fibroblast cells as donors (11.8%, 16/104) than those using foetal fibroblast cells, either starved cells (4.7%, 3/64) or non starved cells (4.3%, 1/11). The major obstacle was oocyte lysis after enucleation.

**Key words:** *in vitro* development, adult and foetal fibroblast cells

#### *Introduction*

There are many factors affecting the efficiency of somatic nuclear transfer. One of them is the source of the donor nucleus. Before the birth of the sheep Dolly in 1997 (Wilmut et al., 1997), rabbit embryos at stages, between 8-cell to blastocyst, had been used to study nuclear transfer (reviewed by Heyman and Renard, 1996; Wolf et al., 1998). Nowadays differentiated cells are used, such as fresh cumulus cells (Chesne et al., 2002), cultivated cumulus cells (Yin et al., 2000) and adult fibroblasts (Dinnyes et al., 2001). The fibroblast cells can be obtained not only from adults but also from foetuses and be used as donor cells in a nuclear transfer program. In this paper, we report on the *in vitro* development of cloned rabbit embryos, using adult and foetal fibroblast cells, as donors.

#### *Preparation of Donor Cells:*

Adult fibroblasts and foetal fibroblasts were obtained according to the techniques reported in Chapter 3. The cells were starved by culturing in DMEM+0.5% FCS for 5 days, before using. The study was made on 3 groups; AF, adult fibroblasts, SFF, starved foetal fibroblasts and NSFF, non-starved foetal fibroblasts.

#### *Micromanipulation*

Oocytes were obtained after superovulation according to our report in Chapter 2 and later stained with 5  $\mu$ M Hoechst 33342 (Sigma, USA) for 15 min when the fluorescent metaphase and the first polar body were removed under an ultraviolet microscopy, with a 20  $\mu$ m (inside diameter) glass pipette, in TCM 199 HEPES (Gibco, USA), together with 0.3% BSA (Gibco, USA) and 7.5  $\mu$ g/ml cytochalasin B. Medium

sized-fibroblasts, with a clear cytoplasm, were transferred to the enucleated oocyte. The enucleation, donor nuclear transfer, fusion, activation and culture were followed, as in our previous reports.

### **Result and Discussion**

In this study, it was found that a high percentage of oocyte lysis occurred in all three groups about 40-60%. Almost all of them were lysed before fusion and activation. This made the number of cultured embryos to be lower than expected. The exposure to Hoechst staining and the trauma from cytoplasmic penetration during enucleation were the causes of lysis. The results in bovines previously showed that the cytoplasm efficiency was reduced after the ultraviolet stain exposure (Smith, 1993) or from the removal of a significant amount of cytoplasm (Westhusin et al., 1996).

Table 7.1: *In vitro* development of cloned rabbit embryos using adult fibroblasts and starved and non starved foetal fibroblasts

Group	Oocytes	Reconstructed oocytes	Cultured oocytes	Cleavage (%)	Development (%)			
					4 cell	8-16 cell	CM	B to HB
AF	259 (10)*	251	136	104 (76.5%) <sup>a</sup>	43 (31.6%)	26 (19.1%)	19 (14.0%) <sup>a</sup>	16 (11.8%)
SFF	182 (8)*	160	64	37 (57.8%) <sup>b</sup>	18 (28.1%)	5 (7.8%)	0 <sup>b</sup>	3 (4.7%)
NSFF	40 (5)*	40	23	11 (47.8%) <sup>b</sup>	5 (21.7%)	4 (17.4%)	0 <sup>b</sup>	1 (4.3%)

(\*) \* replications, % of cleavage calculated by no. of cultured oocytes

AF=adult fibroblasts, SFF=starved fibroblasts, NSFF=non starved fibroblasts

CM=compact morula, B=blastocyst, HB=hatched blastocyst

Values with different letters (a, b) in the same column differ significantly (chi-square analysis,  $P < 0.05$ ).

In nuclear transfer, enucleation of metaphase II (MII) oocytes is commonly used as the recipient cytoplasm for donor differentiated cells. Metaphase II oocytes can be enucleated blindly by aspirating the first polar body and 10-20% of the adjacent cytoplasm material. It is impossible to visualize metaphase chromatin with standard light microscopy (Mohamed and Takashashi, 1999). In this study, the oocytes were incubated in Hoechst dye before enucleation and it was found that a MII chromatin in a >20hpc oocyte was scattered in at least 3 positions, as shown in Fig 7.2, while for young oocytes (15 hpc), more than 90% was located near the first polar body (Table 7.2, Fig 7.1a). In rabbits, Dinnyes et al. (2001) reported that the metaphase plate was adjacent to the polar body in 55% of the observed oocytes, aged 15 hpc. They suggested that in most cases, the coloration and texture of the cytoplasm allowed visualization of the metaphase plate when using Normarski optics. The metaphase plates in some oocytes were not clearly visible and these oocytes needed epifluorescent staining to verify the success of enucleation.





Figure 7.1: Schematic figure of the metaphase II location as related to the 1<sup>st</sup> polar body. The MII (metaphase) is commonly adjacent to the 1<sup>st</sup> polar body in a young oocyte (15 hpc, a), but in aged oocytes (20 hpc), at least 3 positions; a, b, c of MII can be found (b)

Table 7.2: The ratio of oocytes with the MII close to the polar body (PB) and far from the polar body, when using young oocytes in each experiment of nuclear transfer

Exp.	No. oocytes	closed to PB	far from PB	hCG time
NT14-03	20	16	4	19.30 pm
NT16-03	19	19	-	20.30 pm
NT17-03	21	21	-	19.00 pm
NT18-03	10	7	3	19.00 pm
NT19-03	9	9	-	19.00 pm
total	79	72(91.1%)	7(8.8%)	

NT= Experimental number in nuclear transfer

The effectiveness of enucleation depended on the location of the MII chromatin, with only those located peripherally to the cytoplasm enucleated at the best rate, with less traumatizing of the oocyte. Mohamed and Takahashi (1999) reviewed the literature which only showed a 60% success rate when using a blind enucleation technique. The differences in MII chromatin location was expected to affect migration of the meiotic spindle after postovulatory aging (Webb et al., 1986).



Figure 7.2: A rabbit oocyte before enucleation, stained with Hoechst 33342, in order to visualize the metaphase II (arrow) (x200)

The percentage of successful *in vitro* development was lower for the foetal fibroblast group than for the adult fibroblasts. Only 2.3% of cultured oocytes in the former group reached the blastocyst stage compare to 11.8% in the latter group, which was comparable to that of Dinnyes et al (16-18%). This result seemed to be lower than reported in our previous chapters when using cumulus cells as donor cells, with enucleation performed by a blind technique. It is likely that some of the embryos produced were the result of parthenogenetic development. The cell cycle phase of the donor cells, at the time of nuclear transfer, is one of the factors affecting the efficiency of nuclear transfer (Fulka et al., 1998; Thibault, 2003). The G0-stage foetal fibroblast may not be suitable for cloning and further experiments comparing G0 and Interphase stage foetal fibroblasts need to be conducted to look for the effect of the cell cycle phase on development.

*In conclusion, this study makes progress in terms of the effectiveness of enucleation, using fluorescent staining, although a high percentage of cytoplasm lysis and low in vitro development was recorded. Overcoming these limitations will enable us to produce increased numbers of recipient cytoplasts for the production of cloned embryos.*

**References:**

- Chesne, P., Adenot, P.G., Viglietta, C., Baratte, M., Boulanger, L. and Renard, J.P. 2002. Cloned rabbits produced by nuclear transfer from adult somatic cells. *Nature biotechnology*. 20:366-369.
- Dinnyes, A., Dai, Y., Barber, M., Liu, L., Xu J., Zhou, P. and Yang, X. 2001. Development of cloned embryos from adult rabbit fibroblasts: Effect of activation treatment and donor cell preparation. *Biol. Reprod.* 64:257-263.
- Fulka, J., First, N.L., Pasqualino, L., and Moor, R.M. 1998. Cloning by somatic cell nuclear transfer. *BioEssays*20:847-851.
- Heyman, Y. and Renard, J.P. 1996. Cloning of domestic species. *Anim. Reprod. Scie.* 42:427-436.
- Mohamed, M.S. and Takahashi, Y. 1999. Preparation of young preactivated oocytes with high enucleation efficiency for bovine nuclear transfer. *Theriogenology*. 51:661-666.
- Smith, L.C. 1993. Membrane and intracellular effects of ultraviolet irradiation with Hoechst 33342 on bovine secondary oocytes matured *in vitro*. *J. Reprod. Fert.* 99:39-44.
- Thibault, C. 2003. Recent data on the development of cloned embryos derived from reconstructed eggs with adults cells. *Reprod. Nutri. Dev.* 43:303-324.
- Webb, C.B., Hawlett, S.K. and Maro, B. 1986. Parthenogenesis and cytoskeletal organization in ageing mouse eggs. *J. Embryol Exp Morphol.* 95:131-145.
- Westhusin, M.E., Collas, P., Marek, D., Sullivan, E., Stepp, P., Pryor, J. and Barnes, F. 1999. Reducing the amount of cytoplasm available for early embryonic development decreases the quality but not quantity of embryos produced by *in vitro* fertilization and nuclear transplantation. *Theriogenology*. 46:243-252.
- Wilmut I, Schnieke AE, McWhir J, Kind KL, Campbell KHS. 1997. Viable offspring derived from foetal and adult mammalian cells. *Nature*. 385:810-813.
- Wolf, E., Zakhartchenko, V. and Brem, G. 1998. Nuclear transfer in mammals: Recent developments and future perspectives. *J. Biotech.* 65:99-110.
- Yin, X.J., Tani, T., Kato, Y. and Tsunoda, Y. 2000. Development of rabbit parthenogenetic oocytes and nuclear transferred oocytes receiving cultured cumulus cells. *Theriogenology*. 54:1469-1476.

## Chapter 8

### A Comparison of A Cell Fusion Technique and An Intracytoplasmic Donor Cell Injection for The Production of Cloned Mouse and Rabbit Embryos

#### Abstract

The aim of this study was to examine the possibility of using an intracytoplasmic donor cell injection technique to produce cloned mouse and rabbit embryos and compare it to the cell fusion technique, developed previously. The study was divided in two experiments; Exp I, in mice and Exp II, in rabbits. From the study, it was found that lysis of oocytes during micromanipulation was the main obstacle when cloning both mice and rabbit embryos. It was found that the injection technique, caused less development *in vitro* especially in mice, than the fusion technique. However, cumulus cells or fibroblasts can be used as donor cells for intracytoplasmic donor cell injection, which is an advantage.

**Key words** : cell fusion technique, intracytoplasmic donor cell injection, mice, rabbit

#### Introduction

At present, there are two procedures used to produce cloned animals. The cell fusion method, places a donor cell in the perivitelline space of an enucleated recipient oocyte, fusing the donor and recipient cell with electrical pulses and has been used to generate cloned sheep (Wilmut et al., 1997), cattle (Cibelli et al., 1998), goats (Baguisi et al., 1999), pigs (Polejaeva et al., 2000) and rabbits (Chesne et al., 2002). Subsequently, a distinctive nonfusion method, in which donor nuclei were isolated and injected into the cytoplasm of enucleated oocytes was developed, using piezo-driven or a non piezo, mechanical injection method to generate cloned mice (Wakayama et al., 1998). However, this technique requires expensive piezo generators, technical skills and additional equipment. Zhou et al. (2000, 2001) produced cloned mice by the injection technique without using the piezo instrument. In rabbits, cell fusion technique, was developed to produced cloned embryos as described in previous Chapters, however, only Chesne and colleagues (2002) have generated cloned rabbit offspring. The aim of this study was to examine the possibility of using the intracytoplasmic, donor cell, injection technique to produce cloned mouse and rabbit embryos.

### *Materials and Methods*

**Experiment I** : Producing cloned mice embryos by a whole cell intracytoplasmic injection technique

#### *Preparation of oocytes and cumulus cells*

Four to six week-old ICR and C57BL/6J female mice (Fig. 8.1) were superovulated with pregnant mare serum gonadotropin (PMSG, 10 IU) and human chorionic gonadotropin (hCG, 5 IU) by intraperitoneal injections given 48 hours apart. Matured oocytes (M II oocytes, Fig. 8.2) were collected from the oviducts 13 h after hCG injection. Cumulus cells were removed by gentle pipetting in 0.1% hyaluronidase, oocytes and cumulus cells were washed in M2 medium several times. The oocytes were then cultured in M16 medium at 37°C, under 5%CO<sub>2</sub>, in a humidified atmosphere and the cumulus cells were cultured in polyvinylpyrrolidone (PVP) and kept at room temperature until used.

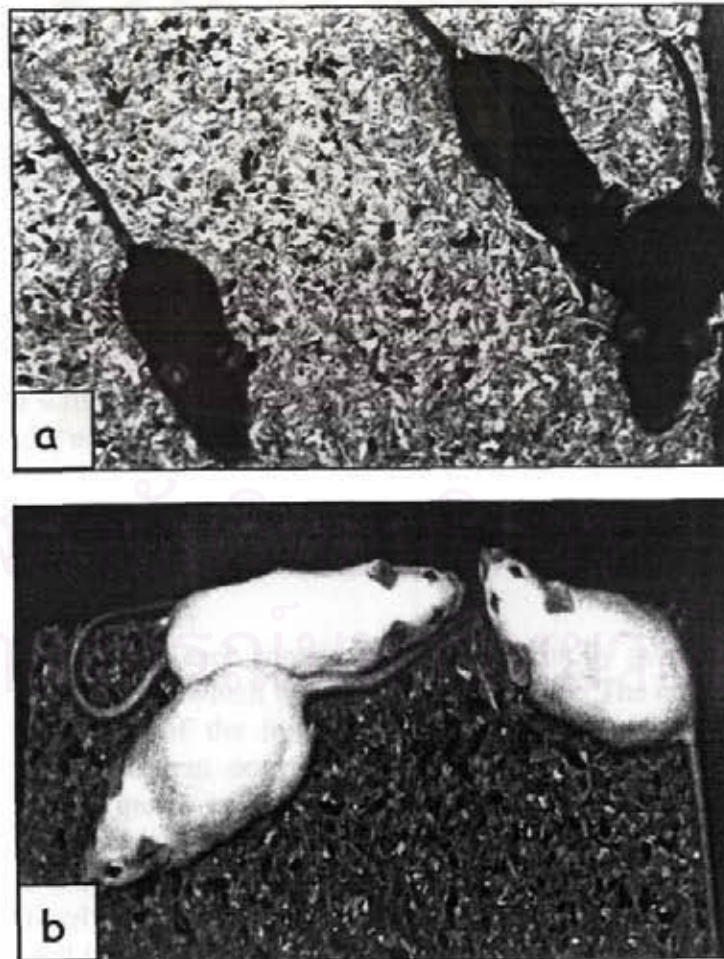

Figure 8.1: Four to six week-old C57BL/6J (a) and ICR (b) female mice



Figure 8.2: Matured mouse oocytes collected after superovulation (x200)

#### *Enucleation of MII oocytes*

MII oocytes were incubated for 5 minutes at 37 °C, in M2 medium containing 5 µg/ml cytochalasin B, then placed in a microdrop of the same medium. For enucleation, the metaphase II plate and a minimal volume of cytoplasm surrounding the metaphase II plate was removed, as described by Zhou et al (2000). The oocyte was rotated by a micropipette to allow visualization of the metaphase II chromatin seen as a bright area in the 4 o'clock region (Kono, 1993). The enucleation pipette, with an outer diameter between 8-10 µm was then gently pushed, first through the zona pellucida, then the perivitelline space with the tip of the enucleation pipette kept in close contact with the plasma membrane above the chromatin area. When drawing out the cytoplasm and chromatin, the pipette will be blocked by the tough chromatin before slowly pulling the pipette out of the perivitelline. The enucleated oocytes were subsequently washed and cultured in M16 medium for 1 h, until they were injected with a cumulus cell.

#### *Injection of cumulus cells*

The cell membrane of each cumulus cell was broken by gentle aspiration, in and out, of the injection pipette which was 5-8 µm of diameter. The cumulus cell was then placed close to the tip of the injection pipette and the pipette inserted into the perivitelline of the recipient oocyte, through the hole made for enucleation. The pipette was advanced gently into the ooplasm until its tip almost reached the opposite side of the oocyte cortex. Gently aspiration of a small amount of cytoplasm into the injection pipette bringing it into performed, bringing into close contact with the donor nucleus. Immediately, the donor nucleus was expelled with the surrounding cytoplasm into the oocyte and the pipette was carefully withdrawn.

### *Activation and embryo culture*

Reconstructed embryos were activated about 1 hour after the injection and then placed in  $\text{Ca}^{++}$  free M16 containing 10 mmol/L  $\text{Sr}^{++}$  and 5  $\mu\text{g/ml}$  cytochalasin B, for 6 h. Activated embryos were cultured in M16 medium and incubated at  $37^\circ\text{C}$ , under 5%  $\text{CO}_2$ , in a humidified atmosphere. The rates of cleavage and the development to the blastocyst stage were recorded. All the processes of intracytoplasmic nuclear injection are presented in Fig. 8.3.

### *Statistical analyses*

Differences in the percentage of oocytes developing to a particular stage were compared by chi-square analysis.

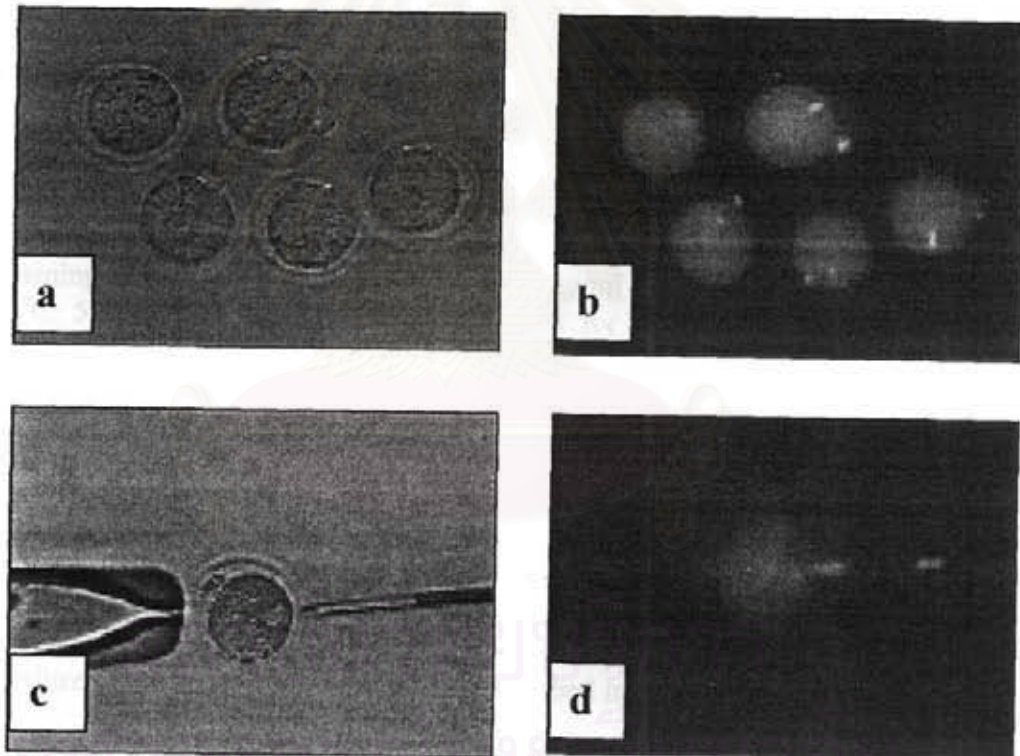

Figure 8.3: The procedure for intracytoplasmic nuclear injection in mice (x200)

- a) The mature oocyte with a visible polar body
- b) The mature oocyte stained with vital dye, Hoechst 33342
- c) A bevelled sharp pipette with a donor nucleus, facing to oocyte, before introducing into cytoplasm
- d) The introduction of micropipette into cytoplasm, stained with vital dye, Hoechst 33342

**Experiment II :** Comparing the production of cloned rabbit embryos using a cell fusion technique and an intracytoplasmic donor cell injection

*Recipient oocyte preparation*

Ovulated mature oocytes were recovered from mature New Zealand White doe rabbits after superovulation, as described in Chapter 2. The oocytes were incubated in 0.1% hyaluronidase, 5% CO<sub>2</sub>, at 38.5°C, for 15 min before the cumulus cells were removed by gentle pipetting.

*Preparation of donor cells*

*I : Fresh cumulus cells*

Fresh cumulus cells from the matured oocytes were recovered at the time of oocyte recovery. The cumulus cells were washed several times, dissociated mechanically by pipetting in TCM199 and preserved in polyvinylpyrrolidone (PVP), at room temperature, until used.

*II : Fibroblast cells*

Fibroblast cell lines were established from skin samples taken from rabbit ear biopsies. The frozen fibroblast cells were thawed and cultured to confluences, which normally took 3-4 days. The confluent culture was then extended for 2-3 days with serum starvation. The technique is described in Chapter 3.

*Enucleation of MII oocytes*

For enucleation, a group of oocytes were transferred into a droplet of TCM199 containing 5 µg/ml cytochalasin B and 5 µg/ml Hoechst 33342 and incubated at 38.5°C, 5% CO<sub>2</sub>, in a humidified atmosphere for 15 min. Enucleation was done by aspirating the first polar body and the metaphase II plate with a small amount of cytoplasm. Successful enucleation was confirmed under UV light.

*Nuclear transfer*

*I : Cell fusion technique*

To transfer the donor nucleus into the perivitelline space of the recipient oocyte by the technique as described in Chapter 4.

*II : Whole cell intracytoplasmic injection (Fig. 8.4)*

The intracytoplasmic donor cell injection was conducted using a similar procedure to the cumulus cell injection, described in Experiment I.

*Fusion and activation of reconstructed oocytes*

The reconstructed oocytes produced by the cell fusion technique were fused and activated as described in Chapter 4. The reconstructed oocytes produced by the intracytoplasmic donor cell (Fig. 8.4) injection technique were washed several times and preincubated for 1 h, in an activation medium, in 38.5°C, 5% CO<sub>2</sub>, in a humidified atmosphere. Activation of this group of oocytes used the same procedure as the one used by the cell fusion technique.



*In vitro culture of reconstructed embryos and parthenotes*

After activation, the reconstructed and control embryos (parthenotes) were thoroughly washed and cultured in a 50  $\mu$ l drop of B2 medium, for 7 days at 38.5°C, 5% CO<sub>2</sub>, in a humidified atmosphere, without any medium changes. The rates of cleavage and development to the blastocyst stage were recorded.

*Statistical analyses*

Differences in the percentages of oocytes developing to a particular stage were determined by chi-square analysis.

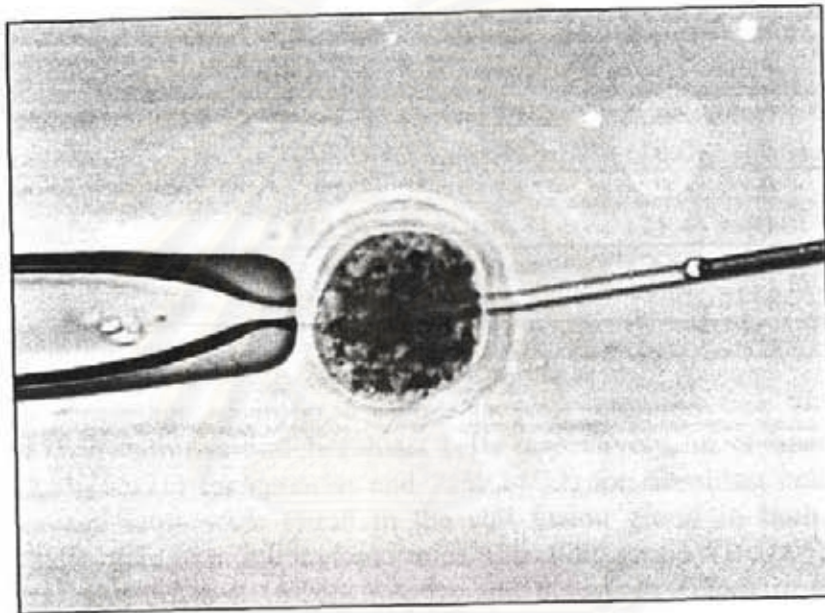

Fig. 8.4: An intracytoplasmic cell injection into a rabbit oocyte (x250)

สถาบันวิทยบริการ  
จุฬาลงกรณ์มหาวิทยาลัย

## Results

From Table 8.1, it can be seen that enucleation succeeded in 36% (41/114) and 42.9% (21/49) in the two strains of mice. The survival rate of intact oocytes was 61.0% (25/41) and 66.7% (14/21) respectively. No injected oocytes cleaved in comparison to that seen in the parthenote group, which was 18.2%(10/55).

Table 8.1: The production of cloned mice embryos by an intracytoplasmic donor cell injection technique

Breed	Treatment	Total oocytes	Enucleated oocytes (%)	Intact oocytes after injection (%)	Culture oocytes (%)	<i>In vitro</i> development			
						2-4 (%)	8-16 (%)	CM (%)	B (%)
ICR	nuclear transfer	114	41 (36.0)	25 (61.0)	4 (16.0)	0 <sup>a</sup> (0.0)	0 (0.0)	0 (0.0)	0 (0.0)
C57BL/6J	nuclear transfer	49	21 (42.9)	14 (66.7)	3 (21.4)	0 <sup>a</sup> (0.0)	0 (0.0)	0 (0.0)	0 (0.0)
	parthenotes	55	-	-	55 (100)	10 <sup>b</sup> (18.2)	0 (0.0)	0 (0.0)	0 (0.0)

CM=compact morula

The percentage of injected rabbit oocytes cultured was 74%(37/50) and 25.3%(22/87) in cumulus and fibroblast cells respectively, in comparison to fused oocytes, 77.5%(55/71) for cumulus and 75%(24/32) for fibroblast cells (Table 8.2). Higher cleavage rates were found in the cell fusion group in both cumulus and fibroblast cells than the intracytoplasmic injection group ( $P<0.05$ ). The cloned embryos can develop to 8-16-cell, morula and blastocyst stages in the cell fusion group while almost all of the cloned, injected embryos did not develop beyond 4-cell stage

Table 8.2. A comparison of the cloned rabbit embryos that were produced using intracytoplasmic donor cell injection (INJ) and a cell fusion technique (CF)

Techniques	Donor cell	Total oocytes	Cultured oocytes (%)	<i>In vitro</i> development			
				2-4 (%)	8-16 (%)	CM (%)	blastocyst (%)
INJ	cumulus	50	37 (74.0)	1 (2.7) <sup>a</sup>	0 (0.0)	0 (0.0)	0 (0.0)
CF	cumulus	71	55 (77.5)	24 (43.6) <sup>b</sup>	2 (3.6)	1 (1.8)	3 (5.5)
INJ	fibroblast	87	22 (25.3) <sup>a</sup>	1 (4.5) <sup>a</sup>	1 (4.5)	0 (0.0)	0 (0.0)
CF	fibroblast	32	24 (75.0) <sup>b</sup>	7 (29.2) <sup>b</sup>	1 (4.2)	0 (0.0)	0 (0.0)

CM = compact morula

<sup>a, b</sup> significant difference ( $P<0.05$ ) in the same column

### **Discussion**

In this study, a technique for intracytoplasmic nuclear injection was developed in mice and rabbits. At the beginning of the development of nuclear transfer techniques in mice, microinjection was used but no mice offspring were born. The first fusion technique was performed successfully by the birth of Dolly (Wilmut et al., 1997). At the present time, new breakthrough techniques to reduce the problems of oocyte lysis and the successful cloning of mice, have done using the piezo-driven mechanical injection method (Wakayama et al., 1998). However, piezo-driven mechanical injection requires a number of technical skills and much additional equipment. In the study, an intracytoplasmic donor cell injection, without piezo, was developed to produce cloned mice and rabbit embryos.

In the first experiment, it was shown that less than 50 % of oocytes survived after metaphase II plate removal. The main cause was oocyte lysis during zona penetration or during withdrawal of the enucleation pipette. It was found that the cytoplasmic membrane of mice is very sensitive and fragile during enucleation. Attempts to reduce the lysis, a minimize trauma at the time of enucleation is required (Zhou et al., 2000). An alternative technique, which can increase the success of enucleation, is a partial zona free or total zona free technique, before enucleation. It was noted that the *in vitro* development of reconstructed mouse embryos was not good and this included the parthenotes group of oocytes. Development blocking at the 2-cell stage was observed. Haydar et al. (2001) has suggested that several strains of mice exhibited a block at the 2-cell stage which may also be caused by adverse culture conditions, such as imbalance in the concentration of certain constituents (Biggers, 1971).

In experiment II, the number of surviving rabbit oocytes, after enucleation was higher than that in mice, because the cytoplasmic membrane of rabbit oocytes is less sensitive to enucleation than the mouse oocytes. This was so even though a larger diameter of enucleation pipette was used, 15-20  $\mu\text{m}\phi$  compared to 8-10  $\mu\text{m}\phi$  in mice. The cloned embryos produced by cumulus cell or fibroblast cell injection can develop the 2-4 cell stage but this is lower than that seen in the cell fusion technique. This result may indicate that donor rabbit cells were not well reprogrammed, so that DNA transcription did not occur (Lee et al., 2003). However, it can be seen from the results that both cumulus cells and fibroblast cells can be a source of donor cells for injection.

*In conclusion*, intracytoplasmic, donor cell injection procedures were not suitable to produce mouse and rabbit cloned embryos. A lower rate of success was seen in both species when compared to the cell fusion technique which has been developed and described in previous chapters.

## References

- Baguisi, A., Behboodi, E., Melican, D.T., Pollock, J.S., Destrempes, M.M., Cammuso, C., Williams, J.L., Nims, S.D., Porter, C.A., Midura, P., Palacios, M.J., Aryes, S.L., Denniston, R.S., Hayes, M.L., Ziomek, C.A., Meede, H.M., Godke, R.A., Gavin, W.G., Overstrom, E.W. and Echelard, Y. 1999. Production of goats by somatic cell nuclear transfer. *Nat. Biotechnol.* 17:456-461.
- Biggers, J.D. 1971. New observations on the nutrition of the mammalian oocyte and the preimplantation embryo. In: Blandau RJ (ed), *Blastocyst Biology*. Chicago: Chicago University Press. :p319-327.
- Chesne, P., Adenot, P.G., Viglietta, C., Baratte, M., Boulanger, L. and Renard, J.P. 2002. Cloned rabbits produced by nuclear transfer from adult somatic cells. *Nat. Biotechnol.* 20:366-369.
- Cibelli, P., Stice, S.L., Golueke, P.J., Kane, J.J., Jerry, J., Blackwell, C., deLeon, F.A.P. and Robl, J.M. 1998. Cloned transgenic calves produced from non-quiescent fetal fibroblast. *Science*. 280:1256-1258.
- Haydar, B., Levent, K., Hande, O. and Hakan, S. 2001. Effect of CZB medium on the two cell block of preimplantation mouse embryos. *Turk. J. Vet. Anim. Sci.* 25:725-729.
- Kono, T., Stomaru, Y., Sato, Y. and Nakahara, T. 1993. Development of androgenetic mouse embryos produced by *in vitro* fertilization of enucleated oocytes. *Mol. Reprod. Dev.* 34:43-46.
- Lee, J.W., Wu, S.C., Tian, X.C., Barber, M., Hoagland, T., Riesen, J., Lee, K.H., Tu, C.F., Cheng, W.T.K. and Yang, X. 2003. Production of cloned pigs by whole cell intracytoplasmic microinjection. *Biol. Reprod.* 69:995-1001.
- Polejaeva, I.A., Chen, S.H., Vaught, T.D., Page, R.L., Mullins, J., Ball, S., Dai, Y., Boone, J., Walker, S., Ayares, D.L., Colman, A. and Campbell, K.H.S. 2000. Cloned pig produced by nuclear transfer from adult somatic cells. *Nature*. 407:86-90.
- Techakumphu, M., Numchaisrika, P., Suktrakun, V., Phanitkitchareon, S., Kaewnanuer, A. and Suwajanakorn, S. 2002. Superovulation responses in rabbits to different doses of follicle stimulating hormone. *Thai J. Vet. Med.* 32(3):53-58.
- Wakayama, T., Perry, A.C., Zuccotti, M., Johnson, K.R. and Yanagimachi, R. 1998. Full term development of mice from enucleated oocytes injected with cumulus cell nuclei. *Nature*. 394:369-374.
- Wilmut, I., Schnieke, A.E., McWhir, J., Kind, A.J. and Campbell, K.H. 1997. Viable offspring derived from fetal and adult mammalian cells. *Nature*. 385:810-813.
- Zhou, Q., Boulanger, L. and Renard, J.P. 2000. A simplified method for the reconstruction of fully competent mouse zygotes from adult somatic donor nuclei. *Cloning*. 2: 35-44.
- Zhou, Q., Jouneau, A., Brochard, P., Adenot, P. and Renard, J.P. 2001. Developmental potential of mouse embryos reconstructed from metaphase embryonic stem cell nuclei. *Biol. Reprod.* 65:412-419.

## Chapter 9

### Conclusion

Nuclear transfer is one of the advanced technologies that can serve either animal production in terms reproductive cloning or humans, in the role of therapeutic cloning. It can also be used for studying basic cell biology. Furthermore, nuclear transfer in cooperation with genetic modification, will serve transgenic technology in the future. In this study every step of the technique of somatic cell nuclear transfer using rabbit oocytes as a model, were developed. Each step influences the success of embryo reconstruction and the *in vitro* development, so that it can be concluded that:

1. Oocytes production by a superovulation program with rabbit does produced a moderate number of oocytes, at an average of 20 per donor, although high variations of response were noted and the season affected the outcome. These oocytes can serve as recipient oocytes in somatic cell nuclear transfer.
2. Somatic cell culture and preservation can be developed by using fibroblast cells from skin and muscle of either adults or foetuses and it was found that these tissues could be cultivated and passaged successfully as donor nuclei in the nuclear transfer program. This technique is already used in other species such as wild endangered, felidae species.
3. The success of the study was determined by cleavage to a 2 cell, 8-16 cell, morula and blastocyst stage during *in vitro* culture. It was demonstrated that fibroblast cells cultured or frozen can be used in a somatic cell nuclear transfer program.
4. The success of somatic cell nuclear transfer can be improved by using a double electrical activation and post-activation with two drugs; cyclohexamide (CHX; a protein synthesis inhibitor) and 6-Dimethylaminopurine (6-DMAP, a kinase inhibitor) after oocyte reconstruction. A higher *in vitro* development rate and later embryo stages; morula and blastocyst, can be produced by this technique.
5. Cumulus cells and muscular fibroblast cells can be used as donor nuclear cells for rabbit cloning and there is no effect from serum starvation of the donor nuclei on the *in vitro* development of cloned embryos.
6. The application of epifluorescent staining helps the effectiveness of enucleation, however a high percentage of cytoplasm lysis and low *in vitro* development was recorded. Overcoming these limitations will enable us to produce increased numbers of recipient cytoplasts for the production of cloned embryos.
7. Finally, the study in mice and rabbits showed clearly that intracytoplasmic, donor cell injection procedures were not suitable to produce either mouse or rabbit cloned embryos. A lower rate of success was seen in both species when it was compared to the cell fusion technique which had been previously developed.