

รายการอ้างอิง

ภาษาไทย

- เป็นหนึ่งใน วานิชชัย และ อาเต ลิซานโตโน(1994). การวิเคราะห์ความเสี่ยงภัยแผ่นดินไหวสำหรับประเทศไทย. วิศวกรรมสาร ฉบับวิจัยและพัฒนา วิศวกรรมสถานแห่งประเทศไทย ปีที่5 ฉบับที่1 พ. ศ. 2537 หน้า 69-91
- สมาลี ประจวบ และ บุรินทร์ เวชบรรเทิง (1992). Earthquake Data Report of Thailand and Adjacent Areas 1983-1989. กรมอุตุนิยมวิทยา, กรุงเทพมหานคร.
- สุรจักร สัมพันธ์รักษ์. วิศวกรรมปฐพี พิมพ์ครั้งที่1 พ.ศ. 2540. กรุงเทพมหานคร: วิศวกรรมสถานแห่งประเทศไทย

ภาษาอังกฤษ

- Abbiss, C., P. (1981). Shear wave measurements of the elasticity of ground. Geotechnique, Vol.31.No.1,pp 91-104.
- Abbiss, C., P. (1986). The effects of damping on the interpretation of geophysical measurements. Geotechnique, Vol. 36, No.4,pp. 565-580
- Alarcon-Guaman, A., Chameau, J. L. Leonard, G. A. and Frost, J. D.(1989).Shear modulus and cyclic undrained behavior of sands. Soils and Foundations, Vol.29, No.4, pp.105-119.
- Ashford, S. A., Jakrapiyanum, W. and Lukkunaprasit, P.(1997). Amplification of earthquake ground motion in Bangkok. Research Report Cu\CE\EVR\1997.002, Department of Civil Engineering, Faculty of Engineering, Chulalongkorn University.
- ASTM D3999-91. Standard Test Methods for the Determination of Modulus and Damping Properties of Soil using the Cyclic Triaxial Apparatus. 1991

- Athanasopoulos, G., A. and Tikou, M. (1990). Site dependent ground response for the 1986 Kalamate earthquakes. Earthquake Resistant Construction and Design. Savidis (Ed.), pp.21-32
- Braja M. Das. Principles of Soil Dynamics. PWS-KENT Publishing Company: BOSTON, 1993
- Chung, R. M., Yokel, F. Y. and Wechsler, H. (1984). Pore pressure buildup in resonant column test. Journal of Geotechnical Engineering. ASCE. Vol.110. No.2 pp.247-261.
- Drnevich, V. P. and Richart, F. E. (1970). Dynamic pre-straining of dry sand. Journal of the Soil Mechanics and Foundation Engineering Division. ASCE. Vol.96. No.SM2, pp.453-469.
- Guha, S., Drnevich, V. P. and Bray, J. D. (1997). Dynamic characteristics of Old Bay clay. Geotechnical Testing Journal. Vol.20. No.4. December, pp.383-393.
- Hadley, P. K., Askan, A. and Cakmak, A. S. (1990). Subsoil geology and soil amplification in Mexico Valley. Earthquake Resistant Construction and Design. Savidis (Ed.), Rotterdam. pp.9-20.
- Hardin, B. O. and Drnevich, V. P. (1963). Elastic wave velocities in granular soils. Journal of the Soil Mechanics and Foundation Engineering Division. ASCE. Vol. 89. No. SM1, pp. 33-65.
- Hardin, B. O. and Drnevich, V. P. (1972). Shear modulus and damping in soils Measurement and parameter effects. Journal of the Soil Mechanics and Foundation Engineering Division. ASCE. Vol. 98. No. SM6, pp. 603-624.
- Hardin, B. O. (1978). The nature of stress-strain behavior for soils. Proc. Earthquake Engineering and Soil Dynamic Conference. ASCE, Pasadena, California. Vol.1, pp.3-90.
- Hardin, B., O. and Black, W., L. (1968). Vibration Modulus of Normally consolidated clay. Proc. ASCE, Vol.94, SM2. pp. 353-369
- Hardin, B., O., and Black, W., L. (1969). Closure to Vibration modulus of normally consolidated clay. J. Soil Mech. And Found. Div. ASCE 95(6). pp1531-1537

- Hight, D., W., Bennell, J.D., Chana, B., David, P., D., Jardine, R., S. and Porovic, E. (1997). Wave velocity and stiffness measurements of the crag and lower London Tertiaries at Size well. Geotechnique, Vol. 47, No.3, pp. 451-474.
- Hisada, T., Nakagawa, K., and Izumi, M. (1965). Normalized acceleration spectra for earthquakes recorded by strong motions accelerographs and their characteristics related with subsol conditions. BRI Occasional Report No.23, Building Research Institute, Ministry of Construction, Japan.
- Ishihara, K. (1976). Fundamental of soil dynamics. Japan: Kagoshima Publishing Company, pp.302.
- Iwasaki, T., Tatsuoka, F. and Takagi, Y. (1978). Shear moduli of sand under cyclic torsional shear test. Soils and Foundations, Vol. 18, No.1, pp. 39-56.
- Jardin, R. J., Symes, M. J., and Burland, J. B. (1984). The measurement of soil stiffness in the triaxial apparatus. Geotechnique, Vol.34 No.3 ,pp.323-334
- Kenji Ishihara. Soil Behaviour in Earthquake Geotechnics. Clarendon Press: OXFORD, 1996
- Kim, T., C. and Novak, M. (1981). Dynamic properties of some cohesive soils of Ontario. Canadian Geotechnical Journal, 18. pp. 371-389.
- Kokusho, T., Yoshida, Y., and Esashi, Y. (1982). Dynamic properties of soft clays for wide strain range. Soils and Foundations, 22. pp1-18.
- Kudo, H., Kokusho, T., Tanaka, Y., Kawai, T., Sawada, Y., Suzuki, K., and Yajima, H. (1994). Change of S-wave velocity of foundation ground just beneath a building during construction Pre-failure Deformation of Geomaterial. Shibuya. Mitachi and Miura (Eds.), Sapporo, pp. 175-180
- Lanzo, G., Vucetic, M. and Doroudian, M. (1996). Reduction of shear modulus at small strains in simple shear. Journal of the Geotechnical and Geoenvironmental Engineering, ASCE, Vol.123, No.11, pp.1035-1042.

- Larkin, T., J., and Taylor, P., W. (1979). Comparison of down hole and laboratory shear wave velocity. Canadian Geotechnical Journal. Vol.16 No.1, pp. 152-162.
- Lo Presti, D. C. F., Jamiolkowski, M., Lancellotta, R. and Vercellii, L. (1993). Maximum shear modulus Measurement Using Bender Elements in Oedometer Tests. Rivista Italiana di Geotecnica. Vol XXVII. N.1, pp. 5-9
- Marcuson, W. F. and Wahis, H. E. (1972). Time effects on dynamics shear modulus of clays. Journal of the Soil Mechanics and Foundation Engineering Division, ASCE. Vol.98. No.SM12, pp.1359-1372.
- Nakajima, M., Hosono, T. and Shibuya, S (1994). Effects of rate of shear stress increment on cyclic behaviour of clay. Proc. Symposium on Deformation Characteristics of Geomaterials associated with Dynamic Problems of Gound and Soil-structures.JSSMFE,pp. 133-136
- Nishio, S., and Katsura, Y. (1994). Shear wave anisotropy in Edogawa Pleistocene deposit. Pre-failure Deformation of Geomaterials, Shibuya, Mitachi and Miura (Eds), Sapporo, pp. 169-174
- Richart Jr. F. E. (1975). Some effects of dynamic soil properties on soil-structure interaction. Journal of the Geotechnical Engineering Division, ASCE. Vol. 101. No. GT12, pp. 1193-1240
- Rosenblueth, E. (1960). The earthquake of 28 July 1957 in Mexico City. Proc. of 2nd Conference on Earthquake Engineering, Japan, pp. 301-305.
- Salgado, R., Drnevich, V. P., Ashmawy, A., Grant W. P. and Valenas P. (1997). Interpretation of large-strain seismic cross-hole test. Journal of the Geotechnical Engineering Disision, ASCE. Vol. 123. No. GT4, pp. 392-388.
- Seed, H. B. and Idriss, I. M. (1969). Influence of soil conditions on ground during earthquakes. Journal of the Soil Mechanics and Foundations Division, ASCE. Vol. 95. No. SM1,pp. 99-137.

- Seed, H. B., Charey, R.C. and Pamukcu, S. (1991). Earthquake effects on soil-foundation system. Foundation Engineering Handbook, 2nd Edition, Hsai-Yang Faing (Ed.), Van Nostrand Reinhold, pp. 594-670.
- Shibuya, S., Hwang, C. and Mitachi, T. (1997). Elastic shear modulus of soft clays from shear wave velocity measurement. Geotechnique, Vol. 47, No.3, pp 593-603.
- Shibuya, S., Mitachi T., Fukuda, F., and Degoshi, T. (1995). Strain rate effects on shear modulus and Damping of normally consolidated clay. Geotechnical Testing Journal (in press).
- Stokoe, II. K. H. and Woods, R. D. (1972). In-situ shear wave velocity by cross-hole method. Journal of the Soil Mechanics and Foundation Engineering Division, ASCE, Vol. 98, No. SM5, pp. 443-460.
- Tanizawa, F., Teachavorasinskun, S., Yamaguchi, J., Sueoka, T. and Goto, S. (1994) Measurement of shear wave velocity of sand before liquefaction and during cyclic mobility. Proc. of the Pre-Failure Deformation of Geomaterial, Eds., Shibuya, Mitachi&Miura, Vol.1, pp.63-68.
- Tatsuoka, F., Inasaki, T., Fukushima, S., and Sudo, H. (1979). Stress conditions and stress histories affecting shear modulus and damping of sand under cyclic loading. Soils and foundations, Vol. 19, No.2, pp. 19-43
- Teachavorasinskun, S.(1992). Deformation characteristics of sands at small strains. Doctor Thesis, University of Tokyo, Japan.
- Teachavorasinskun, S., Tatsuoka, F., Kenkyo, K. and Yasuhara, K. (1992). Effect of cyclic prestaining on the liquefaction resistance of sand. Behaviour of Offshore Structure Conference, pp. 1345-1357
- Vucetic, M. and Dobry, R. (1991). Effect of soil plasticity on cyclic response. Journal of Geotechnical Engineering 117. pp.89-107.

Wood, H. O. (1908). Distribution of apparent intensity in San Francisco. The California Earthquake of April 18,1906, Report of the State Earthquake Investigation Commission, Carnegie Institution of Washington DC.,pp. 220-245.

Yamazaki H. and Zen K. (1991). Strength reduction and deformation due to cyclic loading. Proc. of GEO-COAST'91.AA. Ballcema, Vol. 1, pp. 661-665



สถาบันวิทยบริการ
จุฬาลงกรณ์มหาวิทยาลัย



ภาคผนวก ก.

ผลการทดสอบ Cyclic Triaxial Test

สถาบันวิทยบริการ
จุฬาลงกรณ์มหาวิทยาลัย



-ผลการทดสอบของตัวอย่างดินมหาวิทยาลัยมหิดล

สถาบันวิทยบริการ
จุฬาลงกรณ์มหาวิทยาลัย

MU/20/50/0.10/1

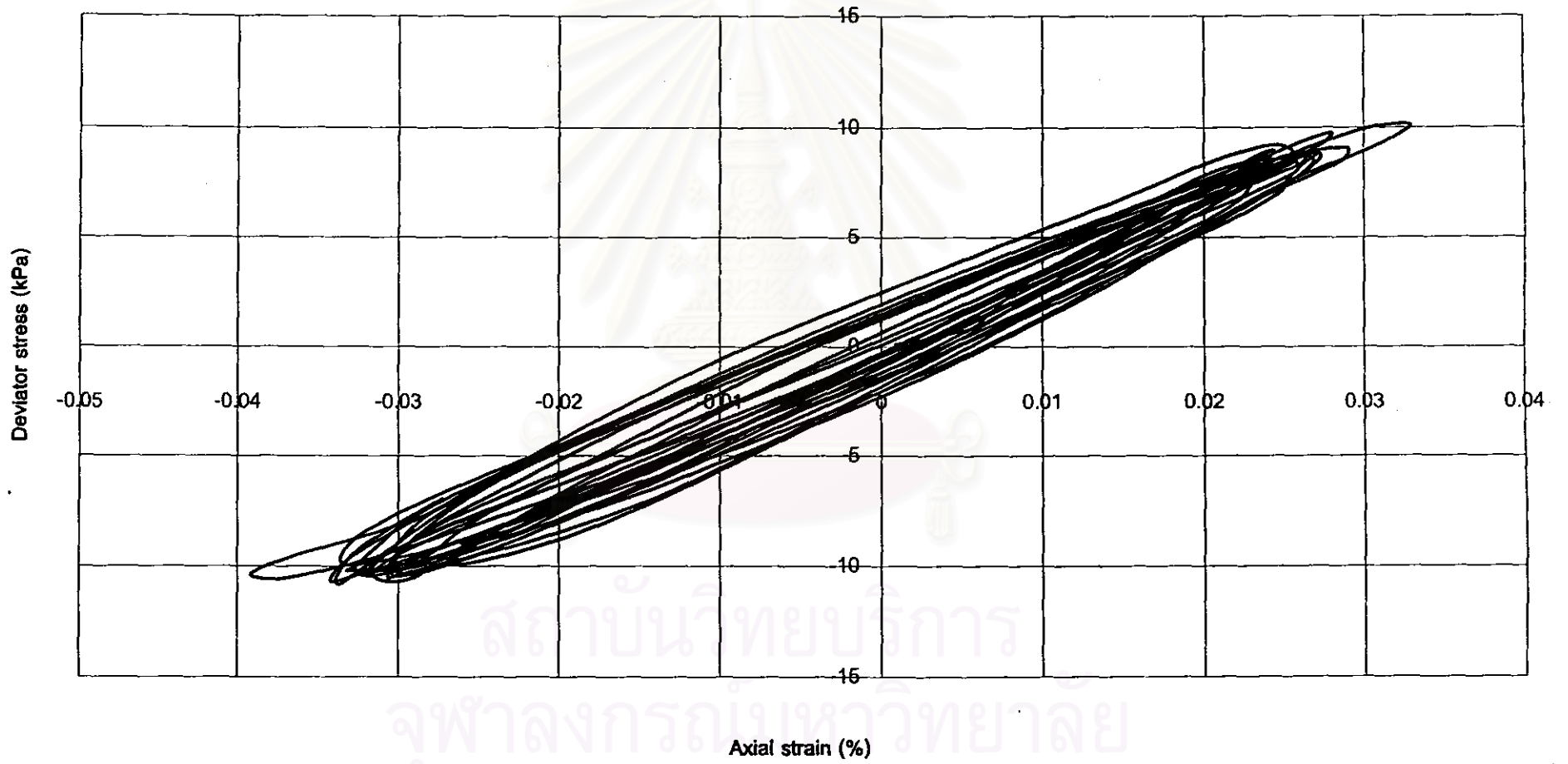

สถาบันวิทยบริการ
จุฬาลงกรณ์มหาวิทยาลัย

MU/40/50/0.10/1

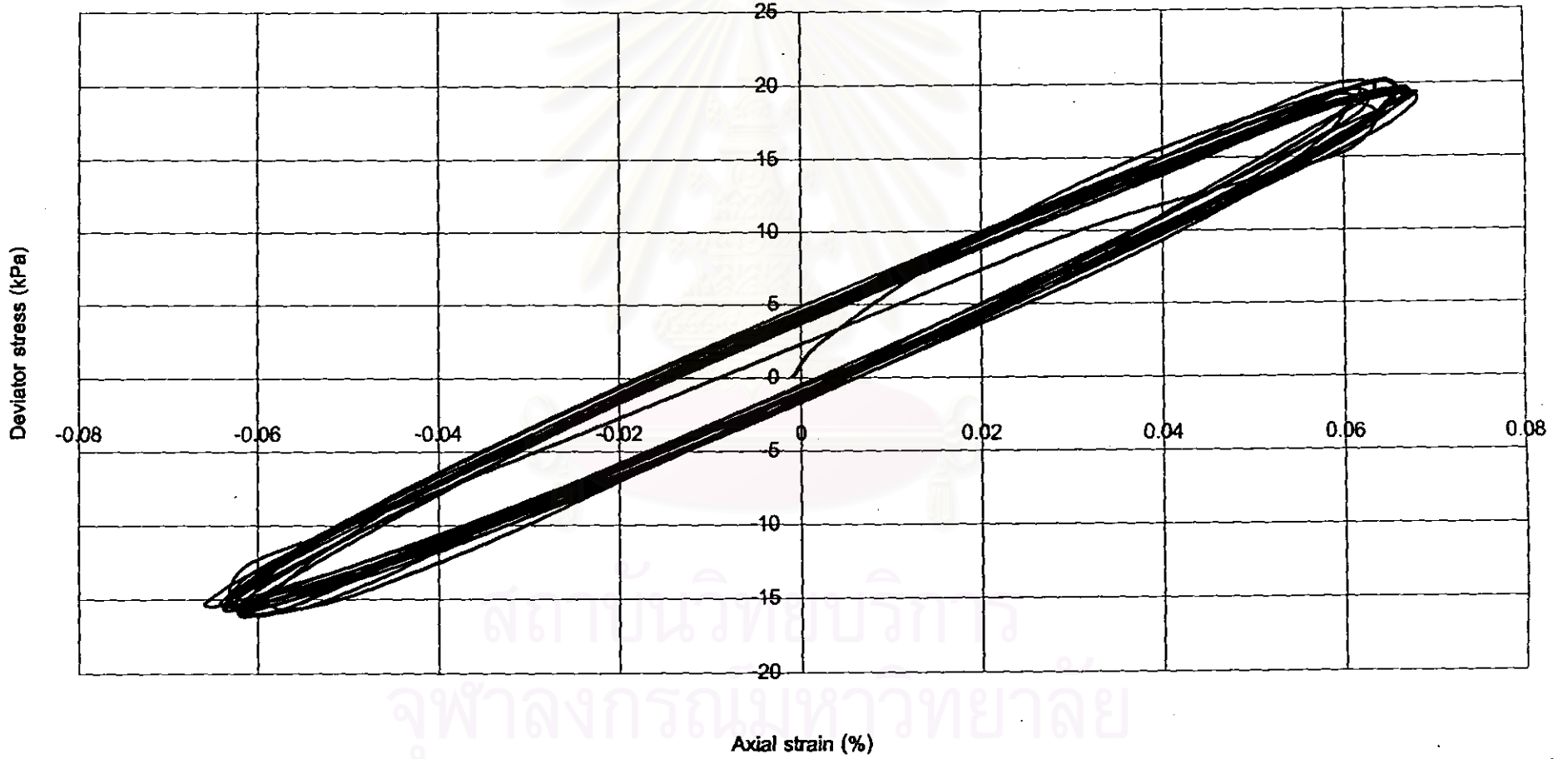

MU/70/50/0.10/1

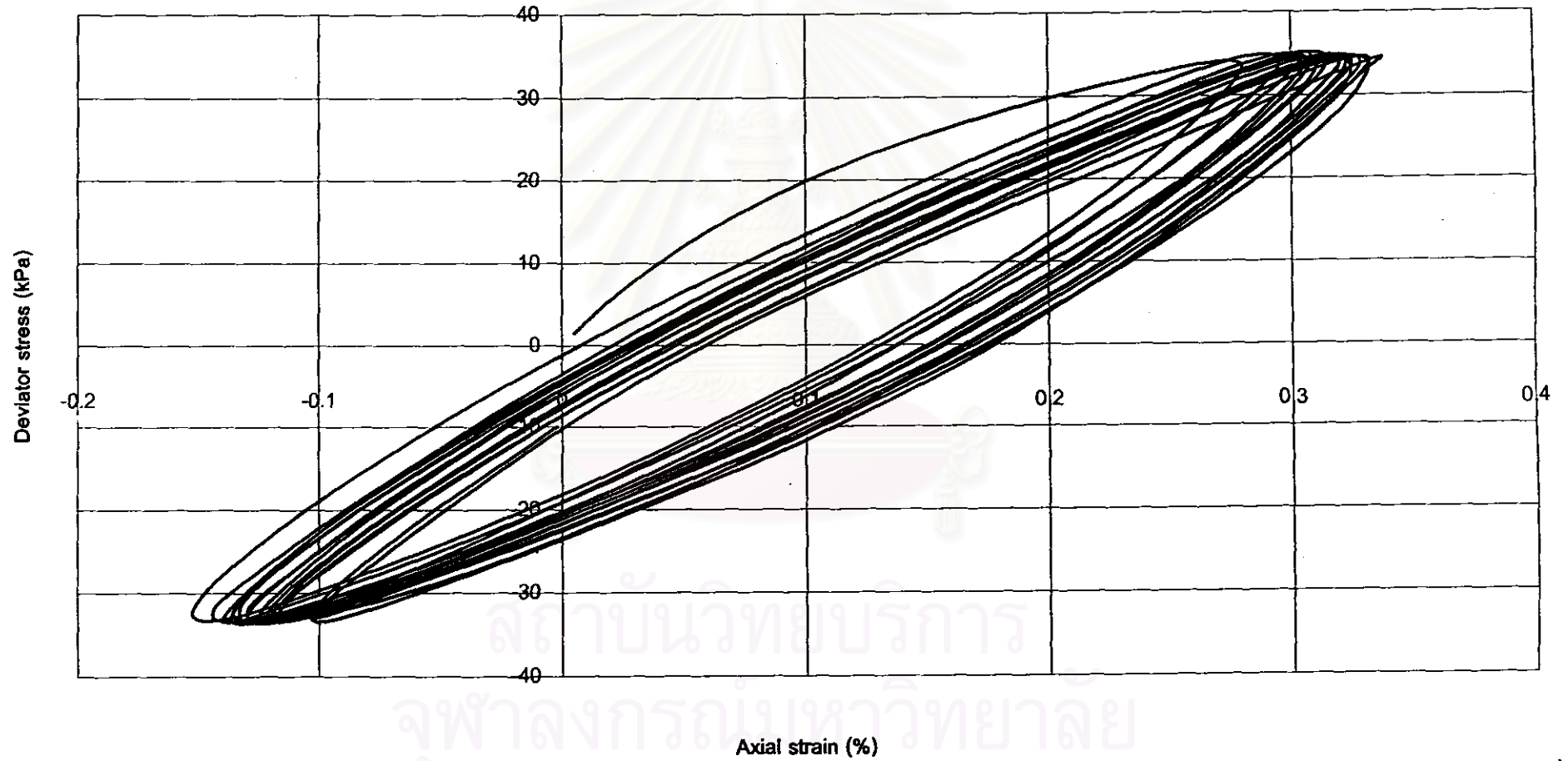

MU/20/50/0.10/2

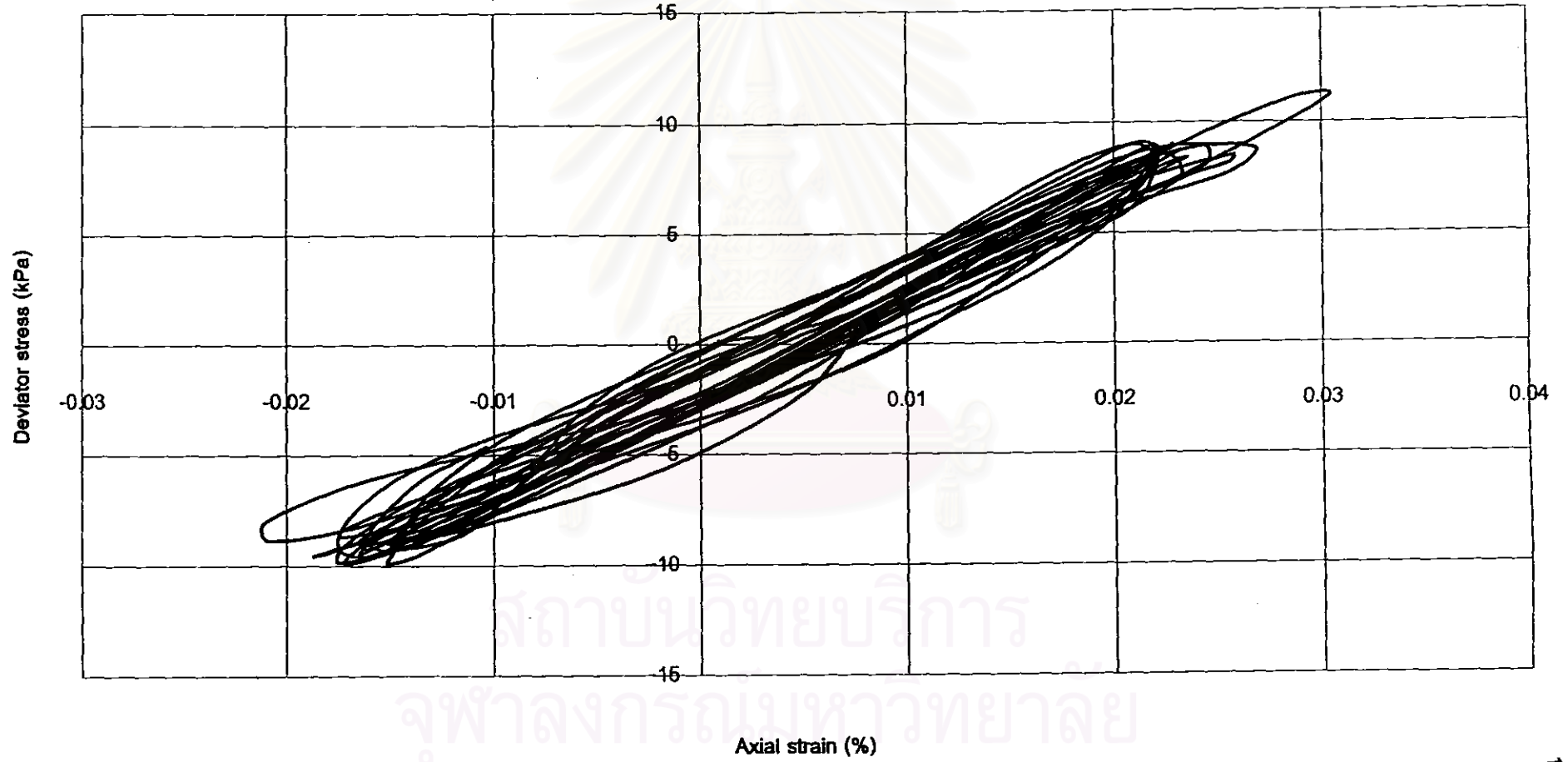

สถาบันวิทยบริการ
จุฬาลงกรณ์มหาวิทยาลัย

MU/40/50/0.10/2

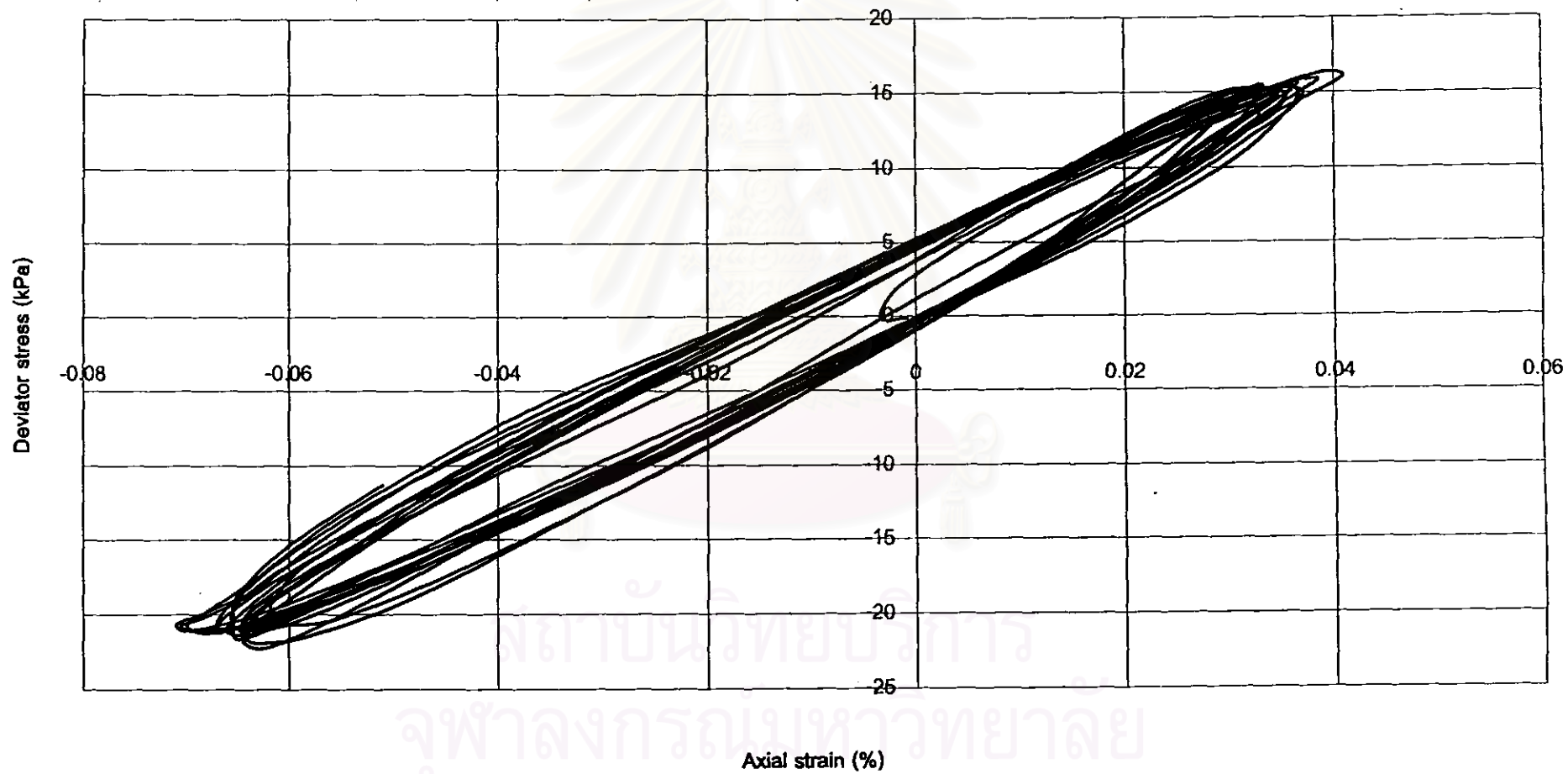

MU/15/50/1.0/1

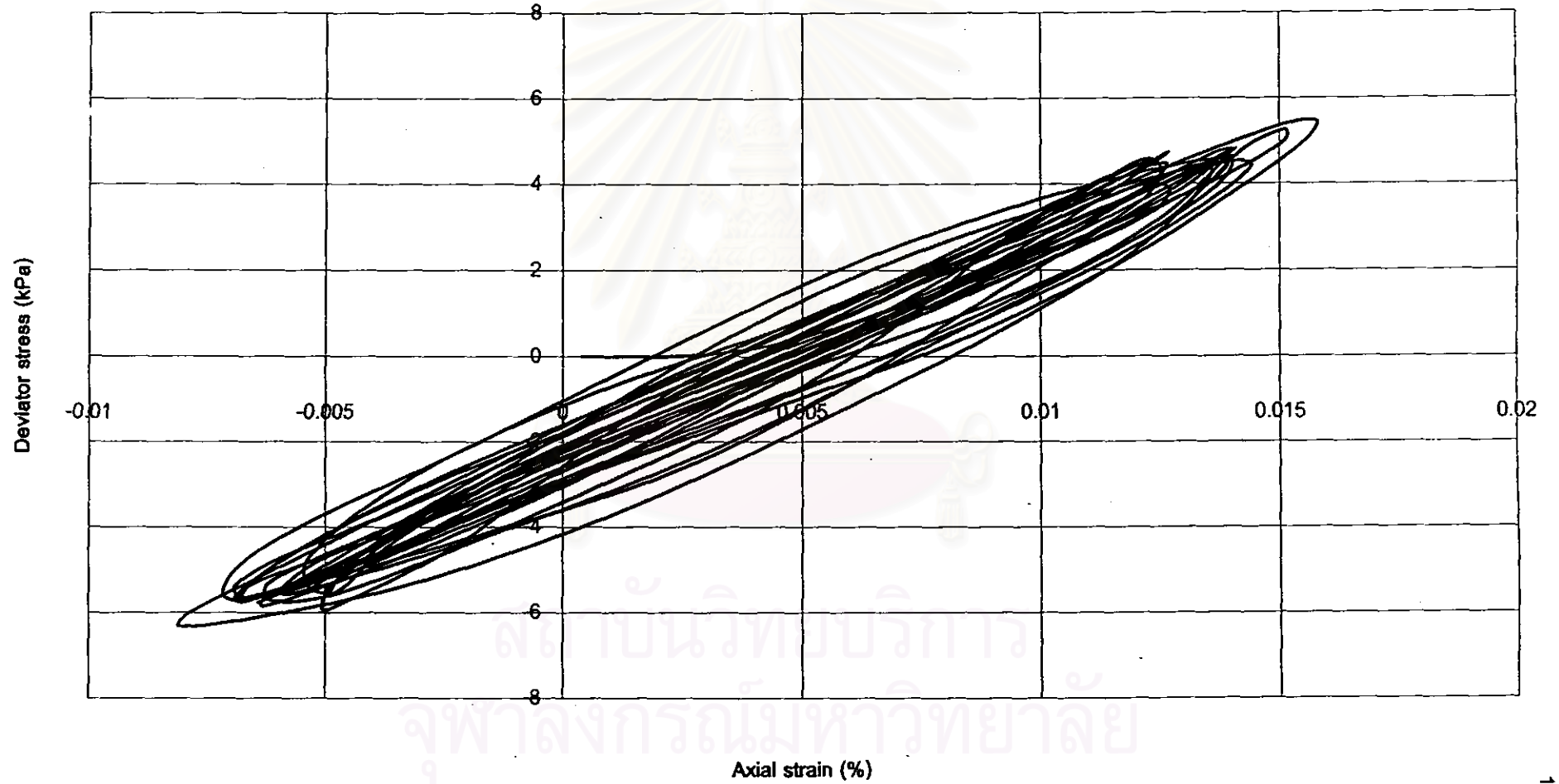

MU/40/50/1.0/1

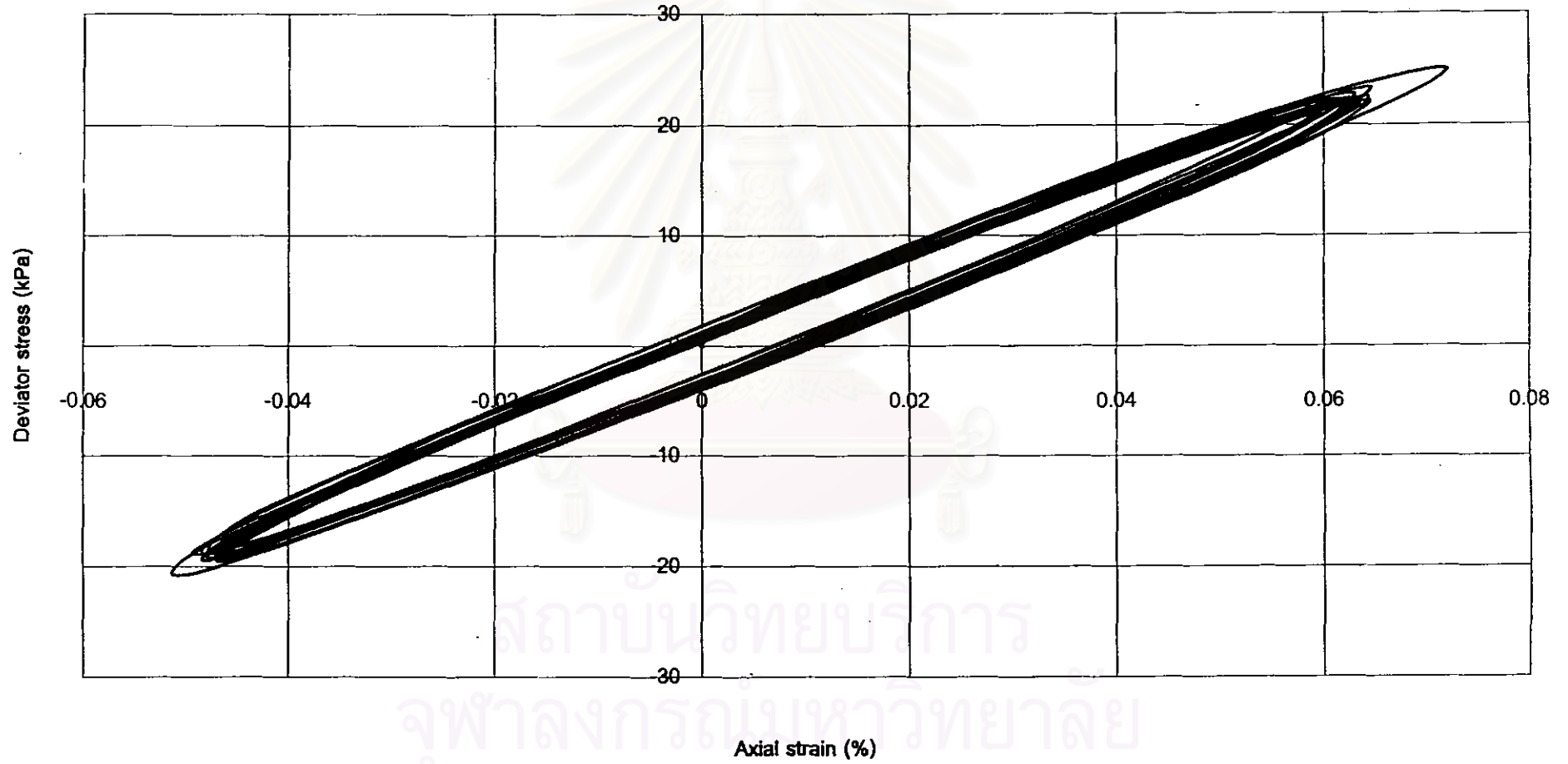

สถาบันวิทยบริการ
จุฬาลงกรณ์มหาวิทยาลัย

MU/75/50/1.0/1

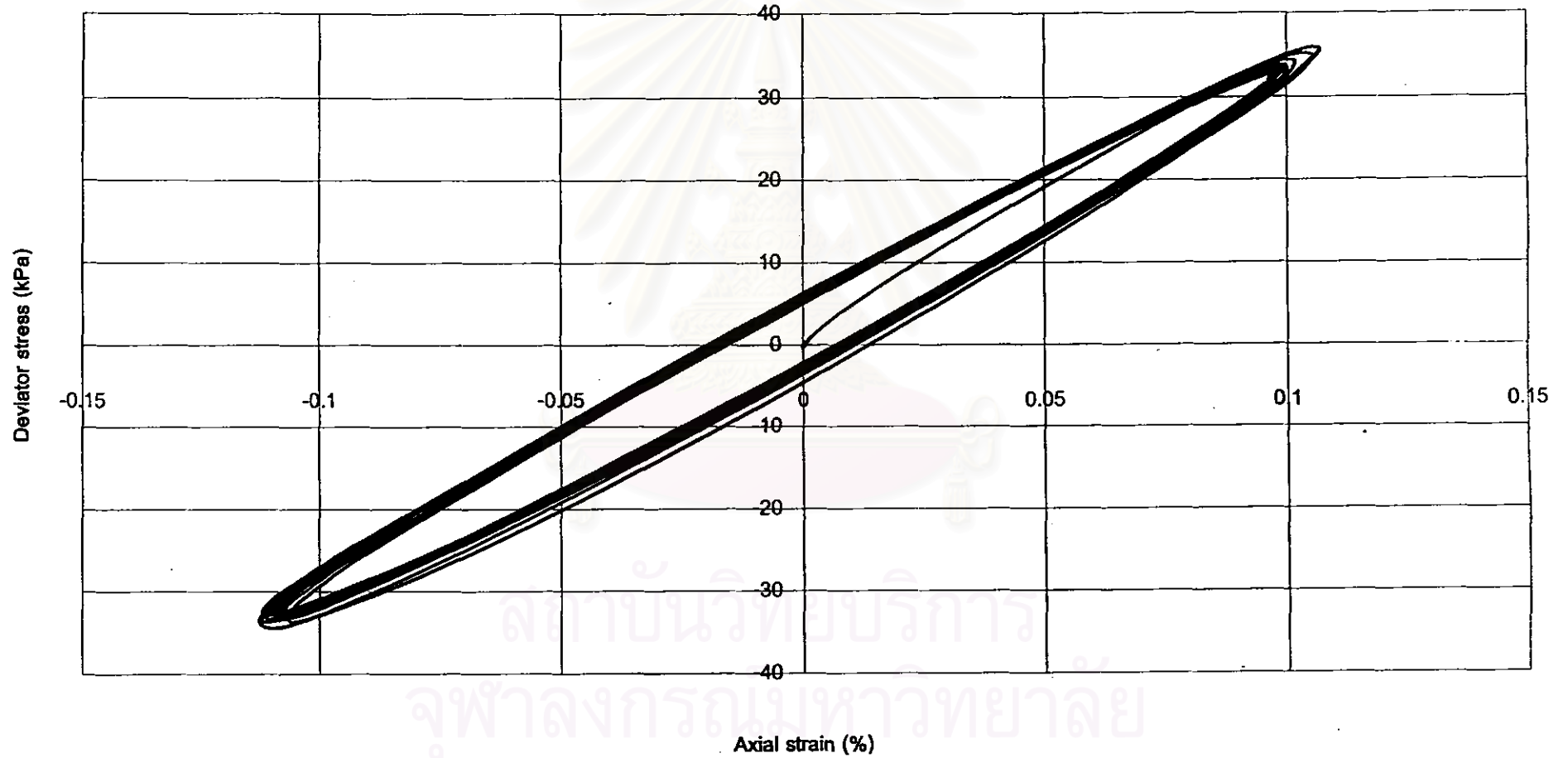

สถาบันวิจัยบริการ
จุฬาลงกรณ์มหาวิทยาลัย

MU/15/50/1.0/2

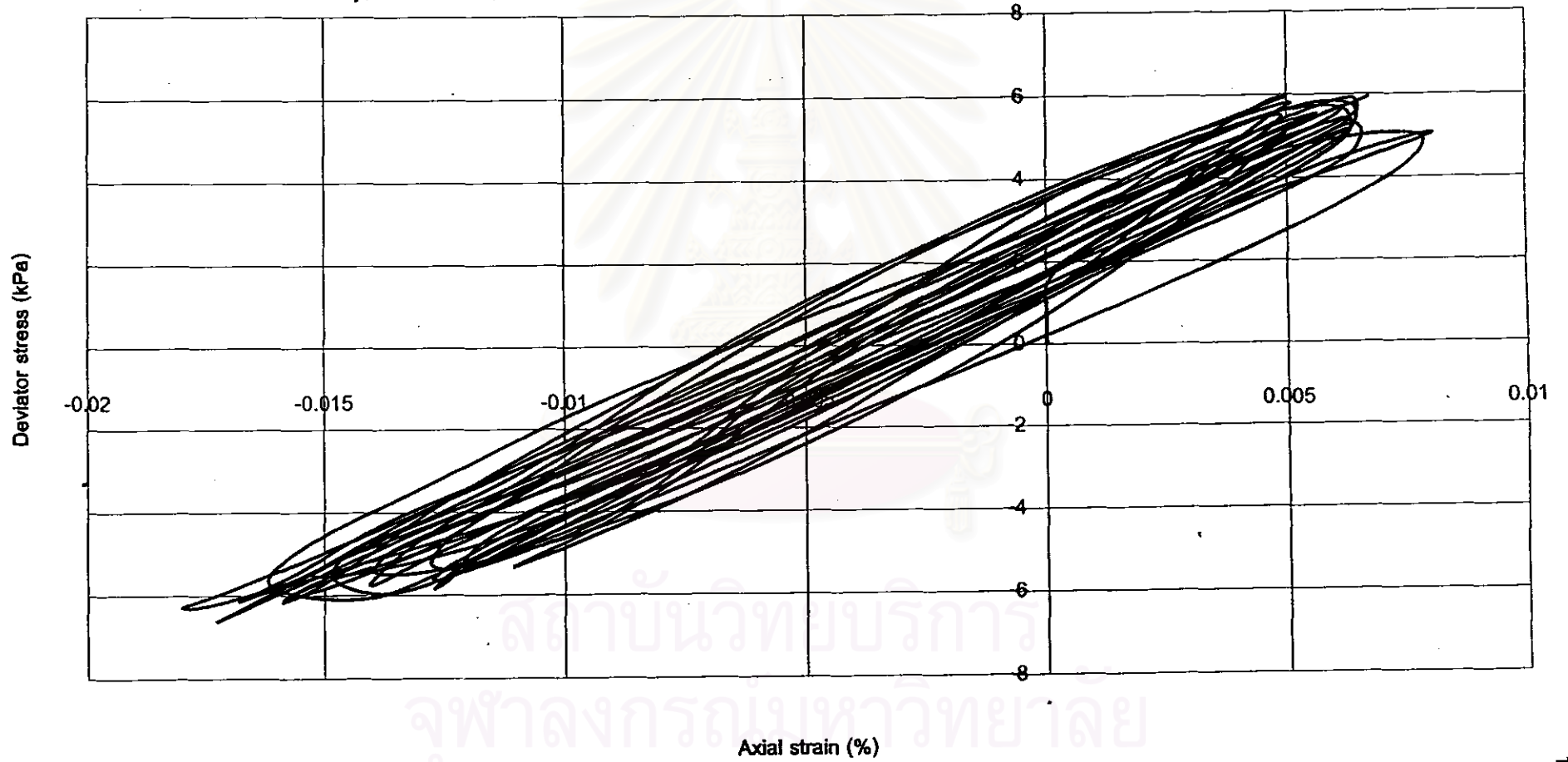

สถาบันวิทยบริการ
จุฬาลงกรณ์มหาวิทยาลัย

MU/80/50/1.0/2

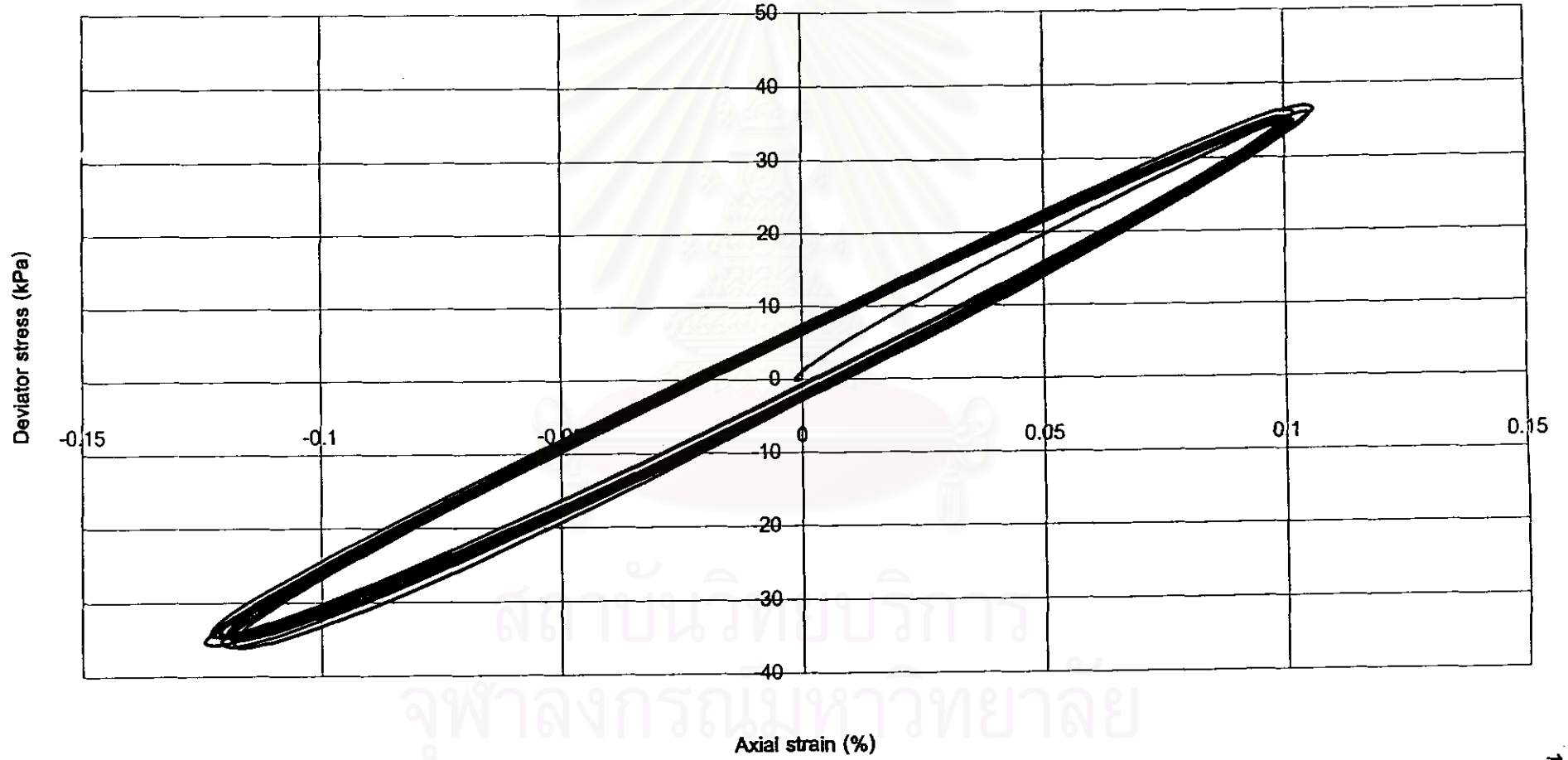

ศูนย์บริการ
จุฬาลงกรณ์มหาวิทยาลัย

MU/100/50/1.0/2

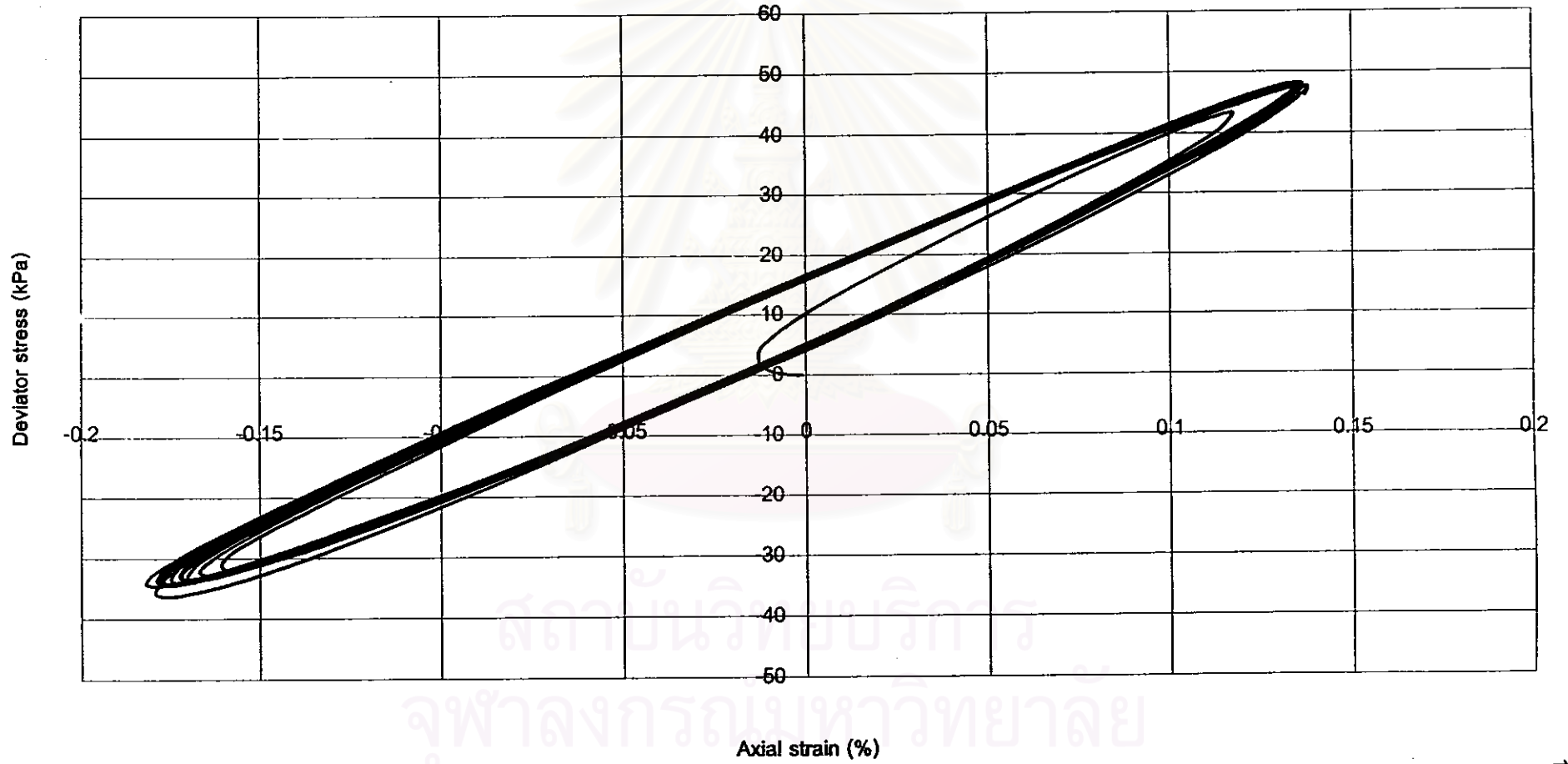

สถาบันวิทยบริการ
จุฬาลงกรณ์มหาวิทยาลัย

MU/30/50/1.0/3

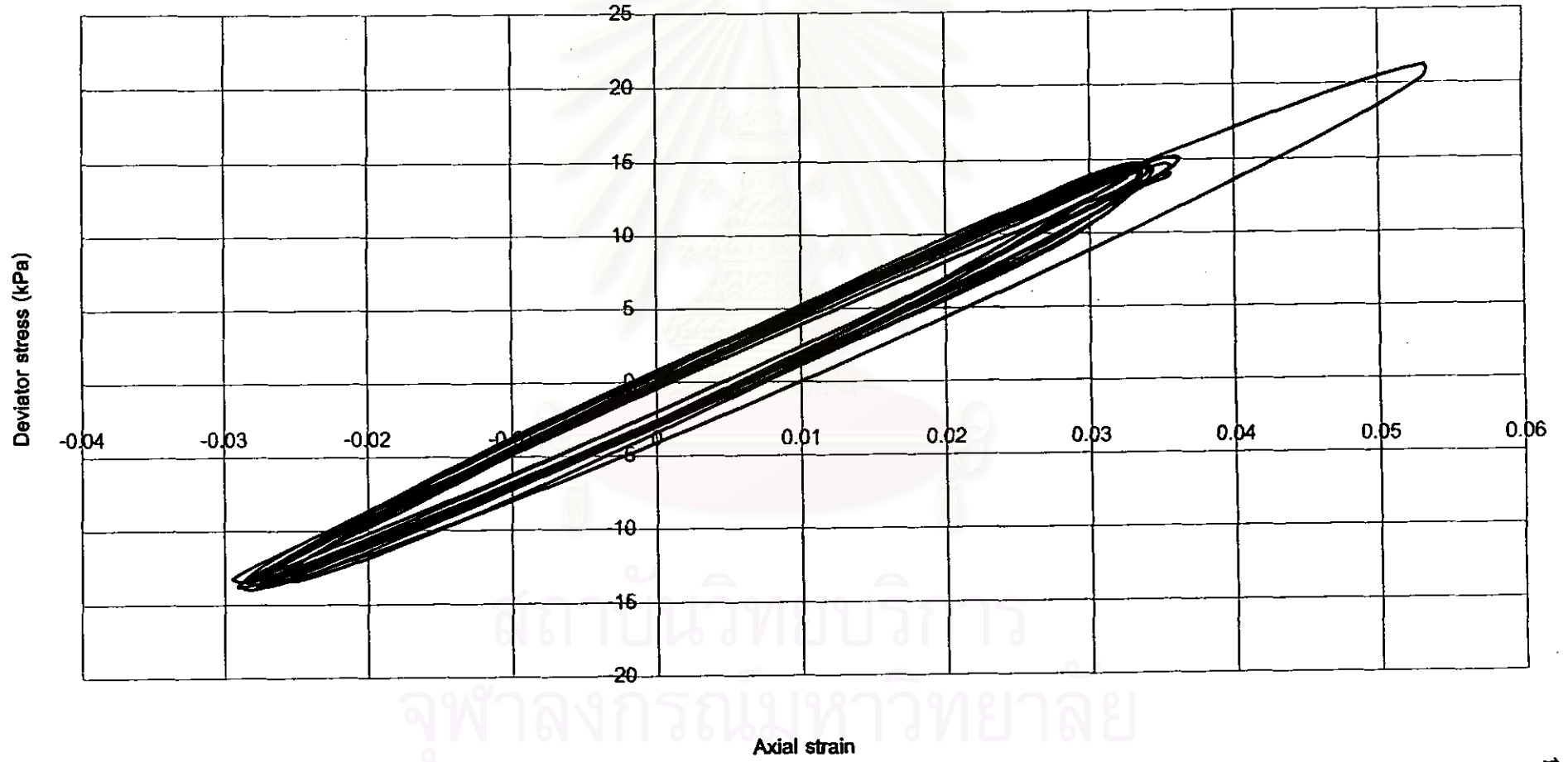

จุฬาลงกรณ์มหาวิทยาลัย

MU/50/40/1.0/3

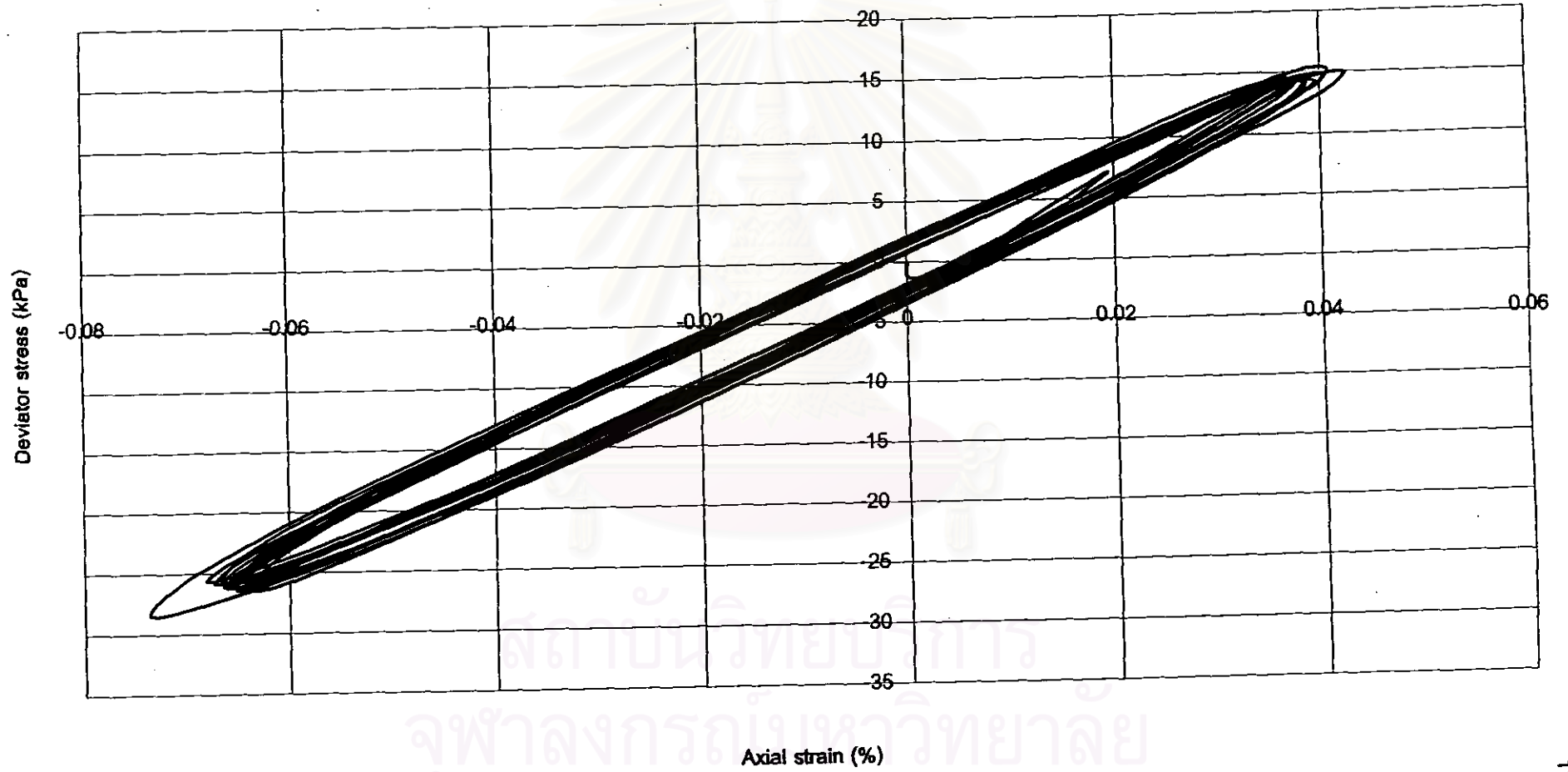

MU/160/50/1.0/3

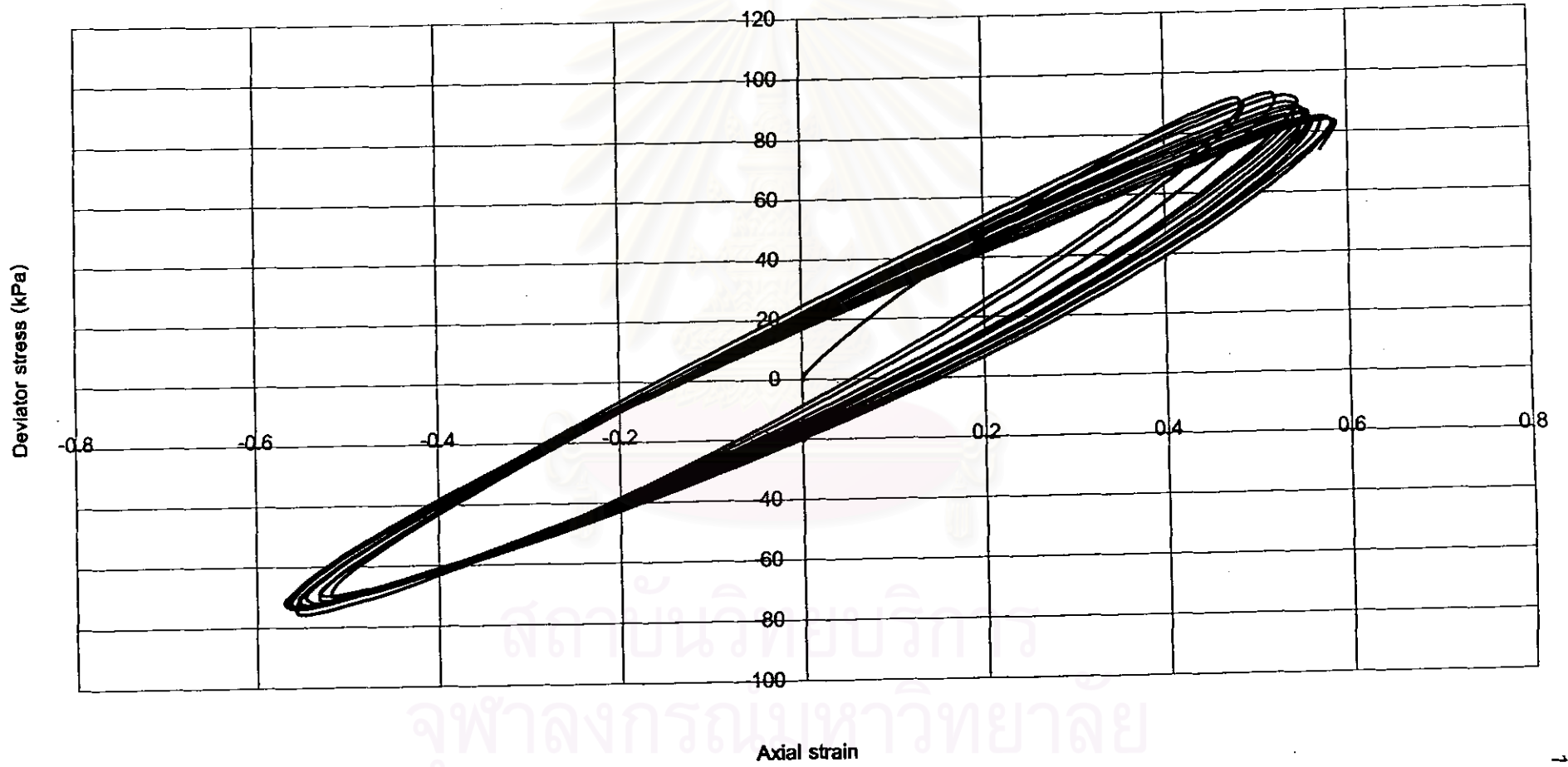

สถาบันวิจัยบริการ
จุฬาลงกรณ์มหาวิทยาลัย

MU/180/50/1.0/3

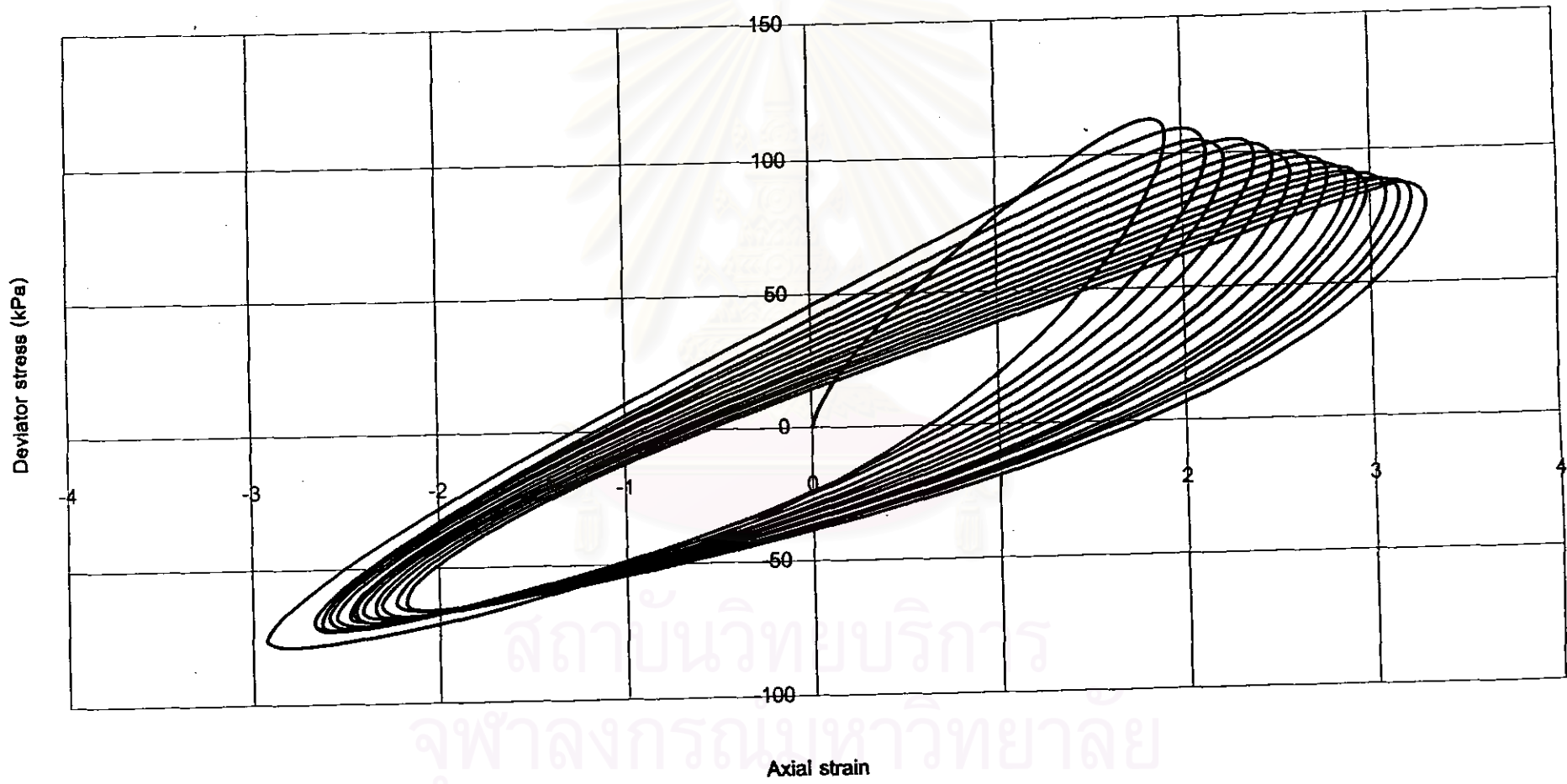

สถาบันวิฑฒบรืการ
จุฬาลงกรณมหาวิทยาลัย

MU/30/150/0.10/1

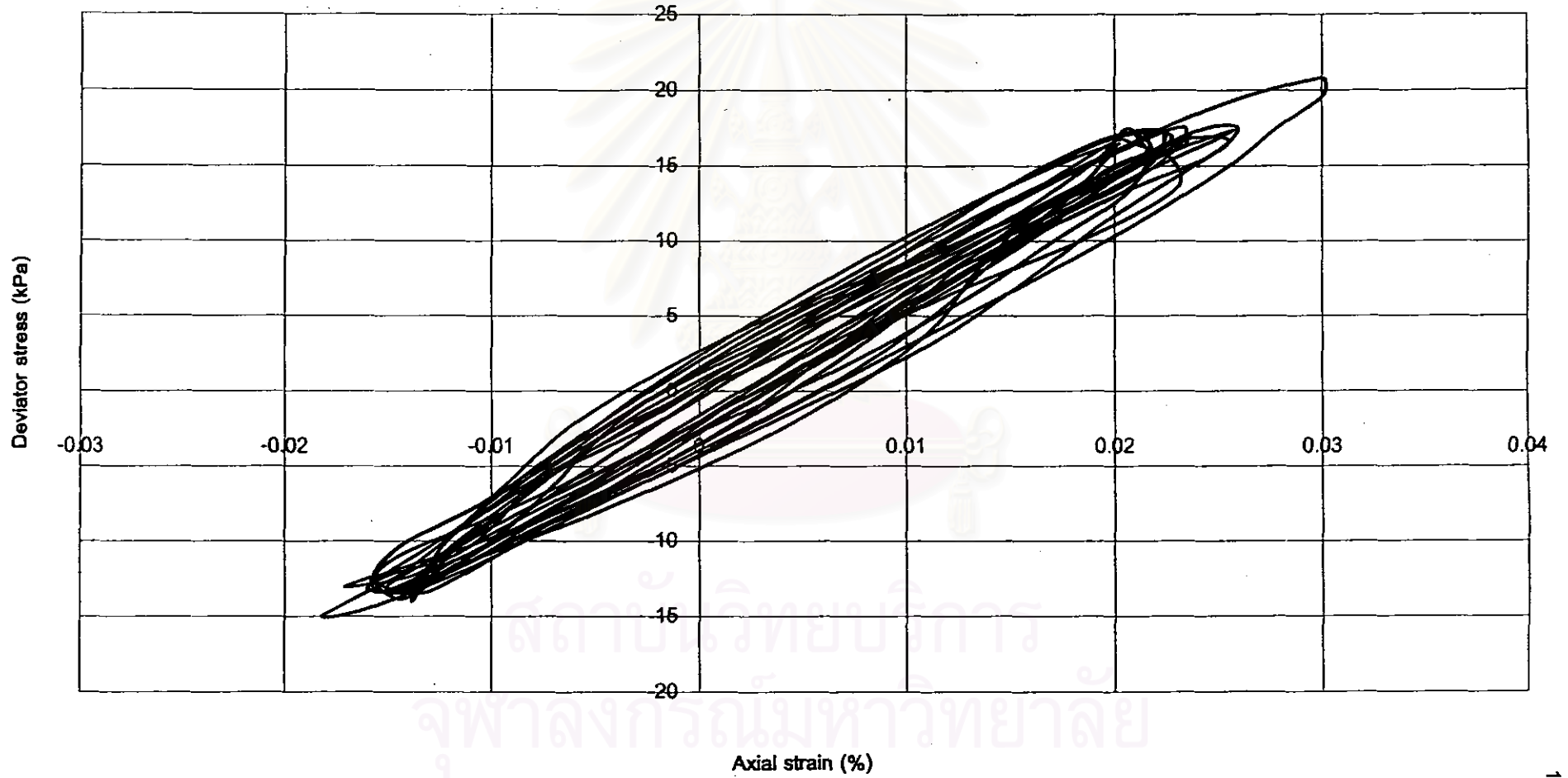

MU/90/150/0.10/1

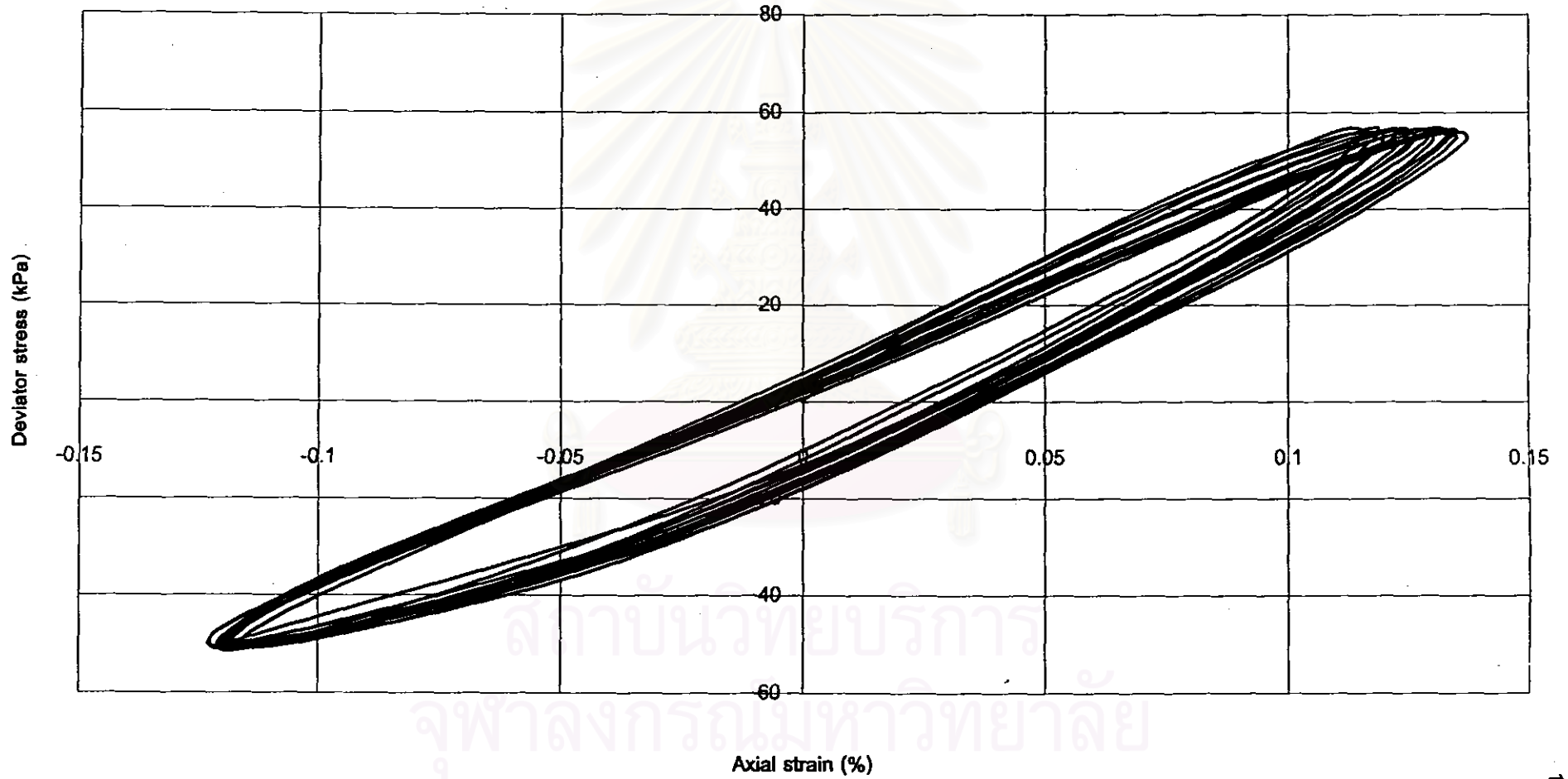

MU/110/150/0.10/2

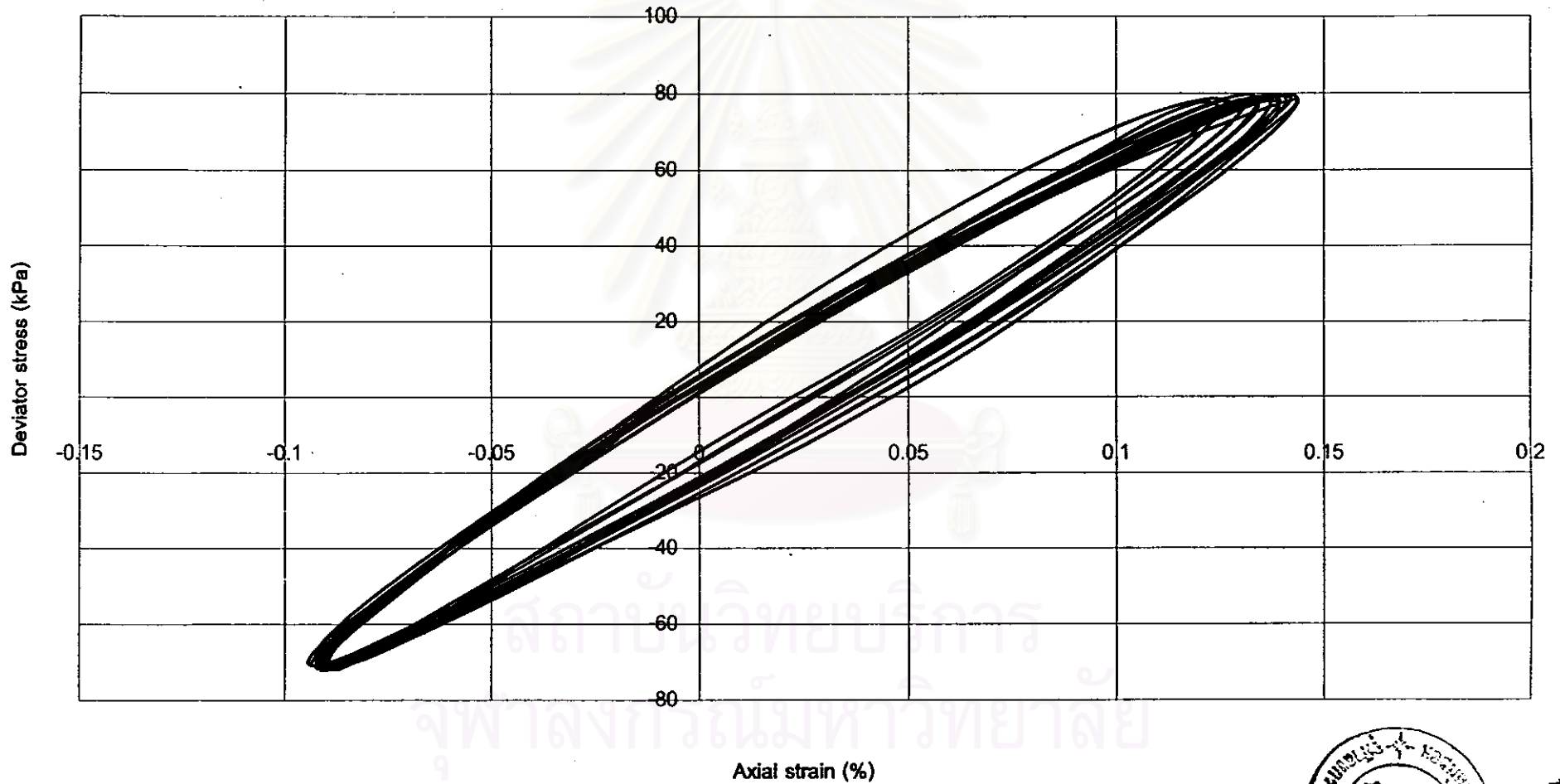

MU/150/150/0.10/2

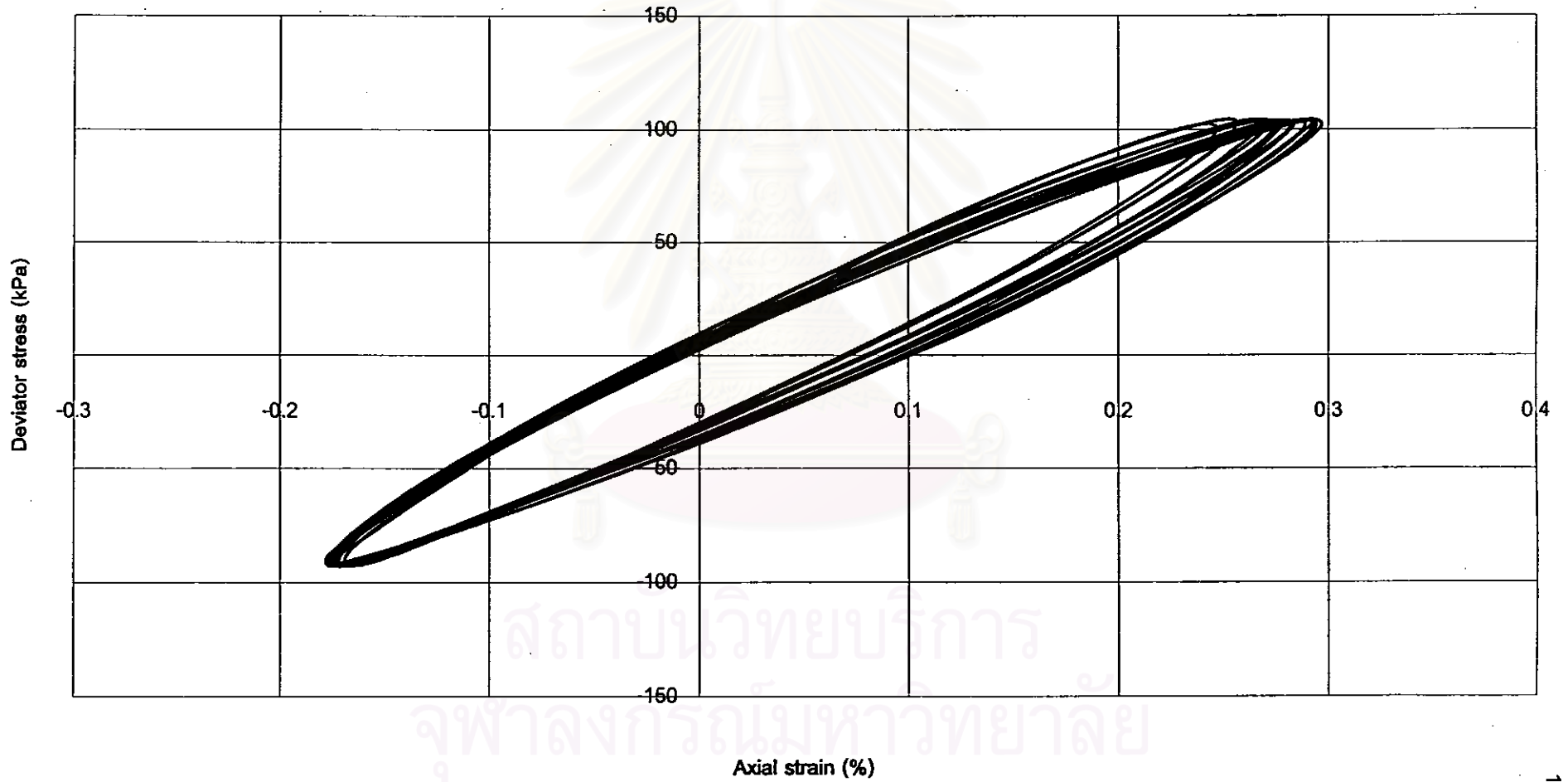

MU/50/150/1.0/1

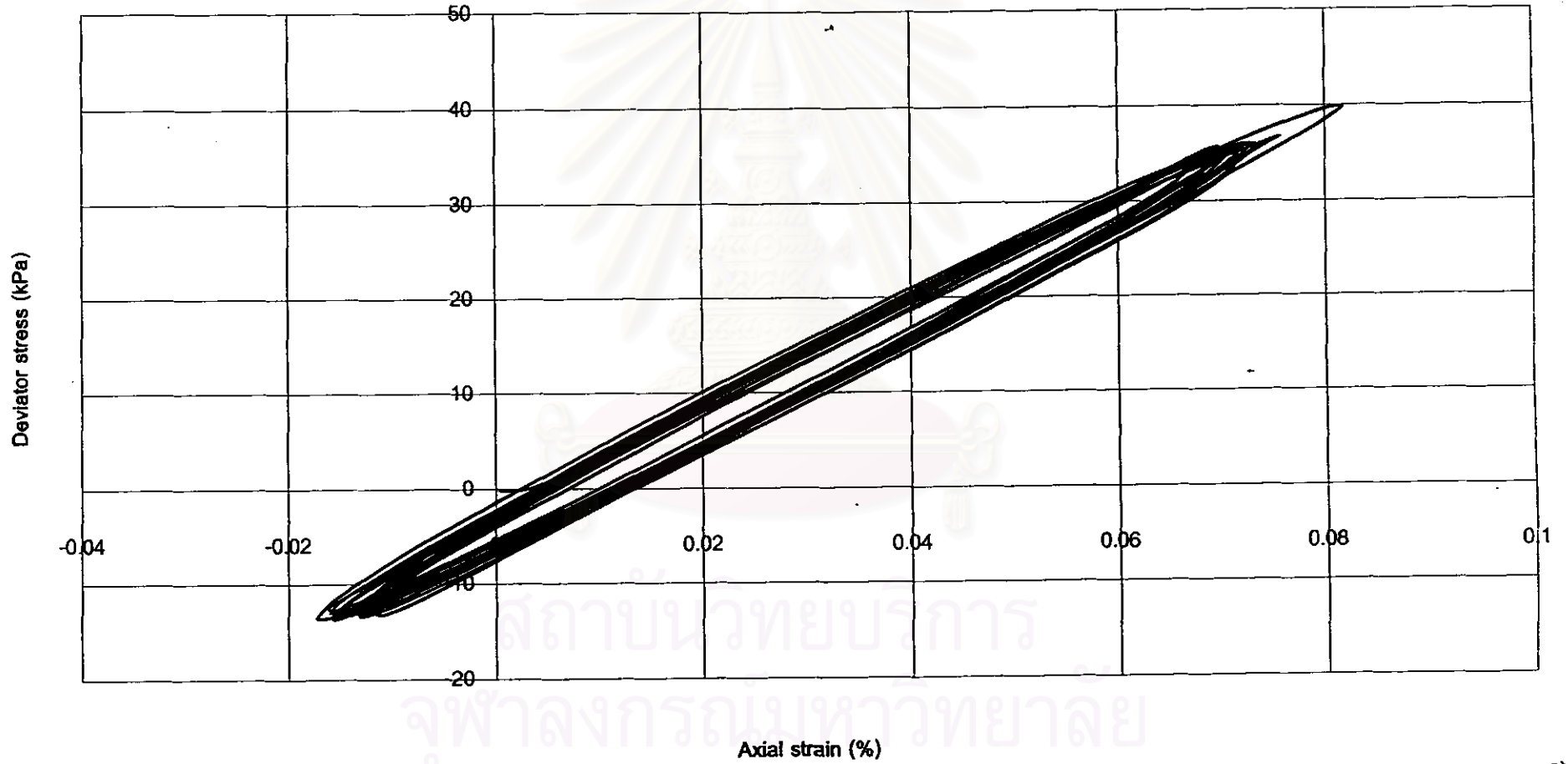

สถาบันวิทยบริการ
จุฬาลงกรณ์มหาวิทยาลัย

MU/100/150/1.0/1

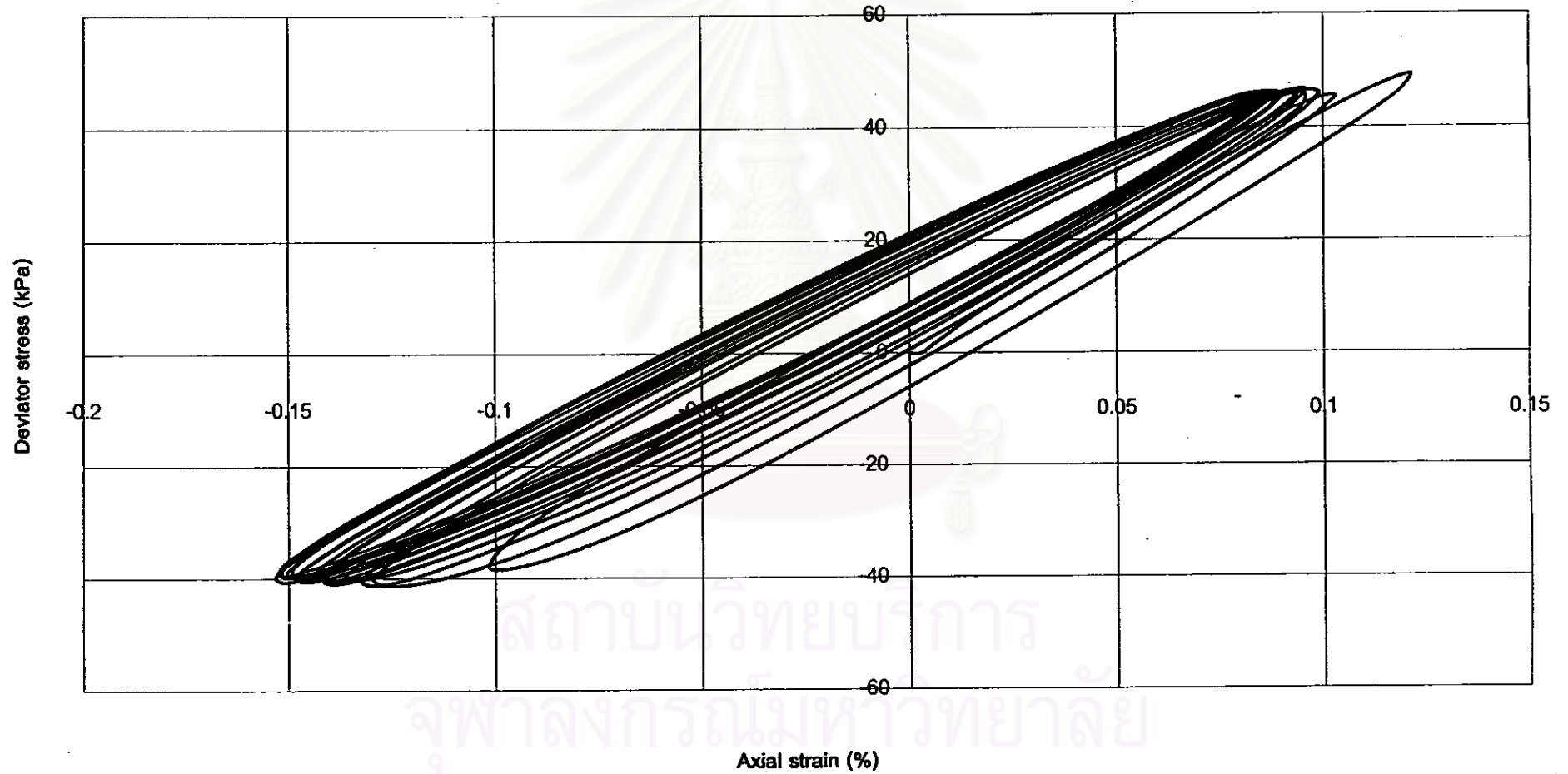

MU/110/150/1.0/2

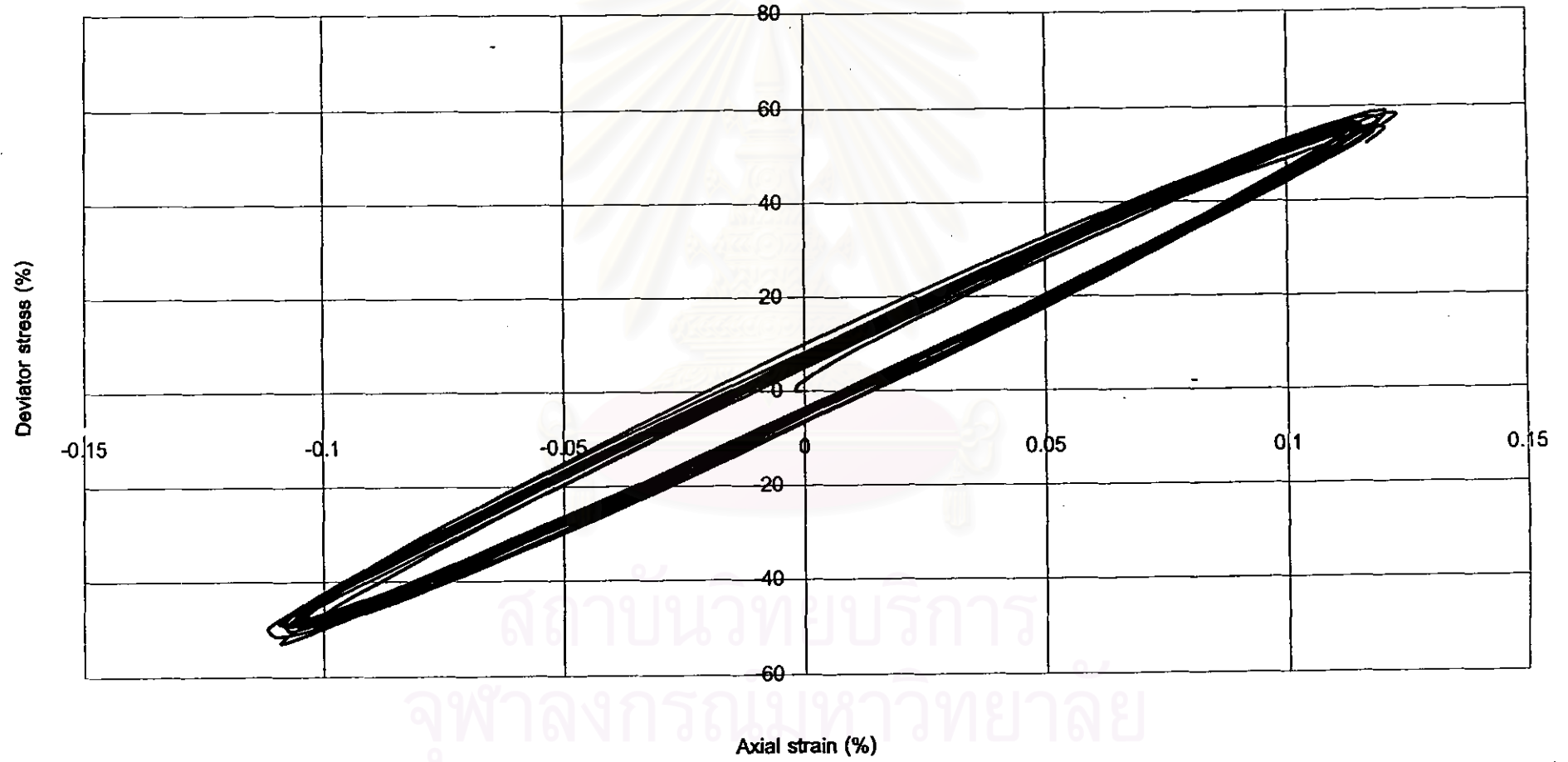

MU/160/150/1.0/2

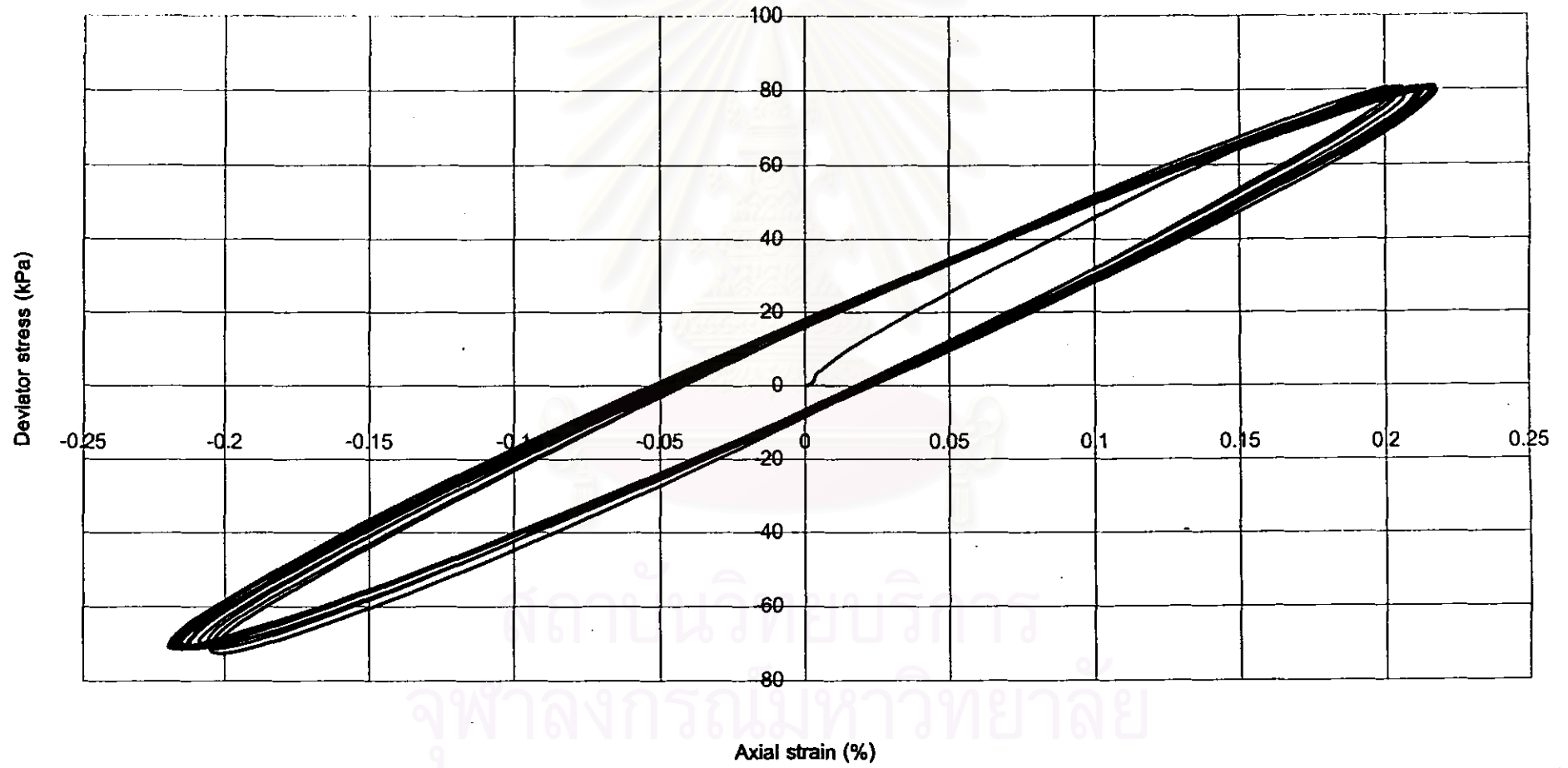

MU/230/150/1.0/3

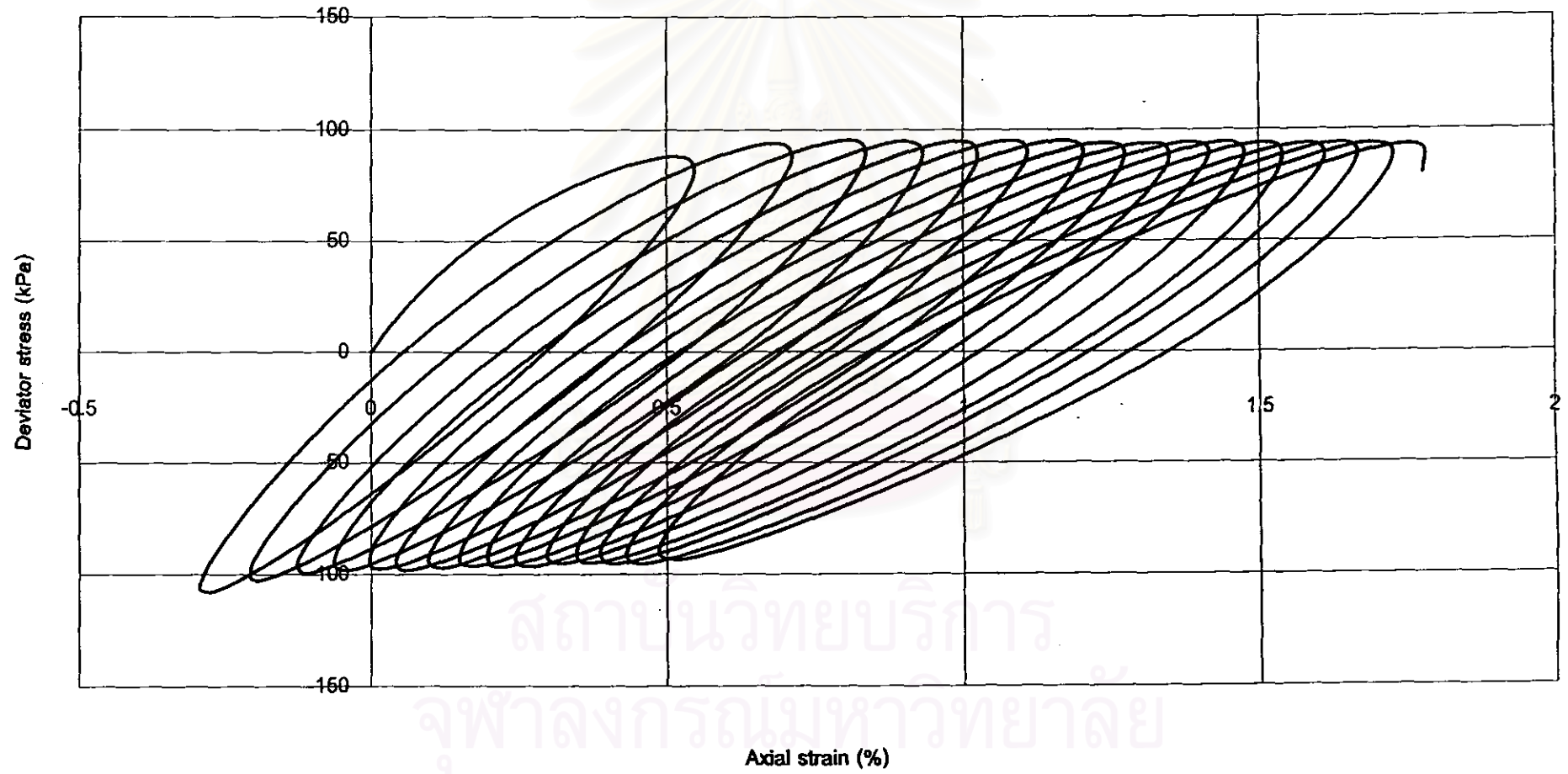

สถาบันวิทยบริการ
จุฬาลงกรณ์มหาวิทยาลัย

Mu/200/150/1.0/3

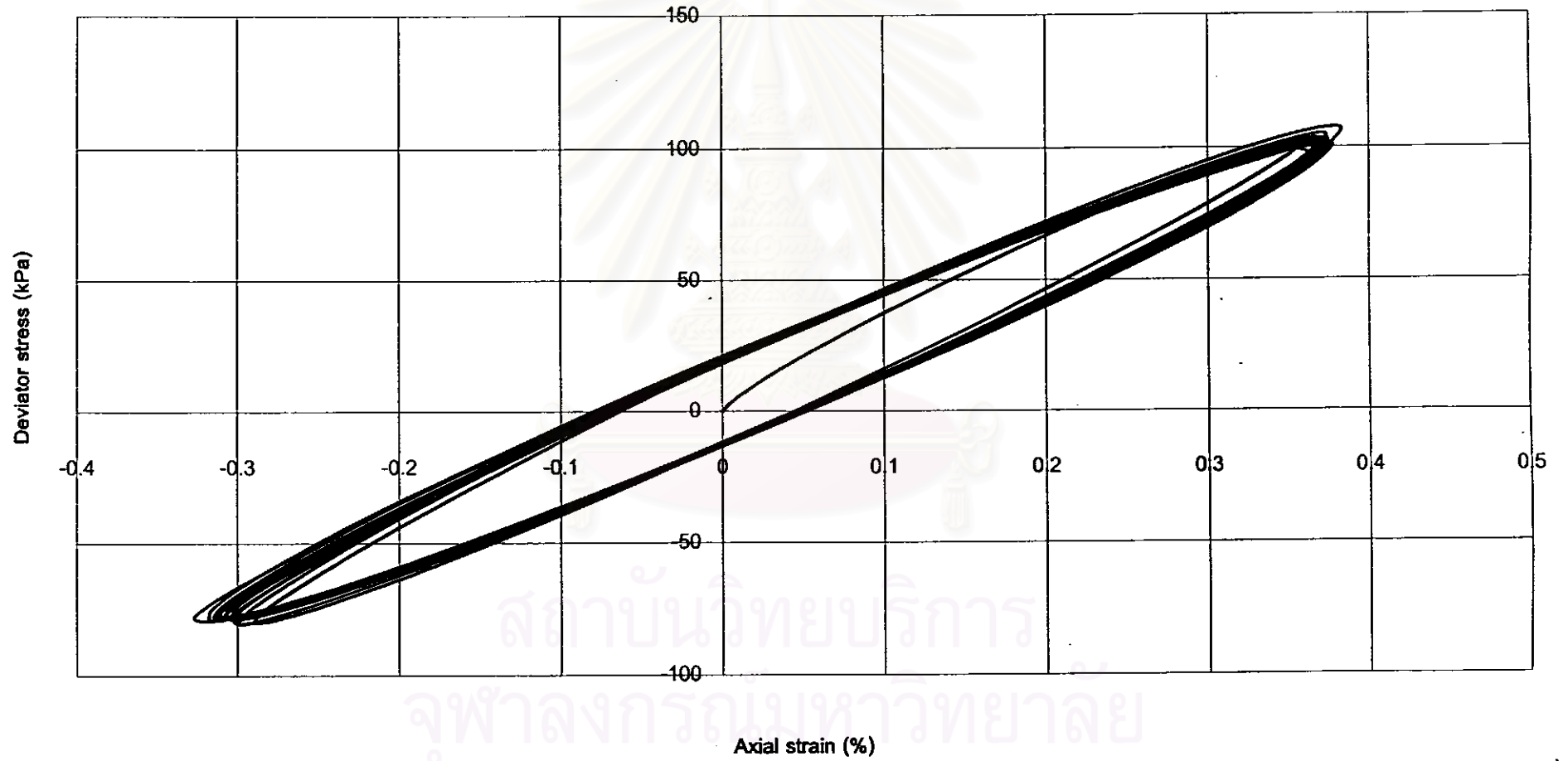

สถาบันวิทยบริการ
จุฬาลงกรณ์มหาวิทยาลัย

MU/250/30/0.10/1

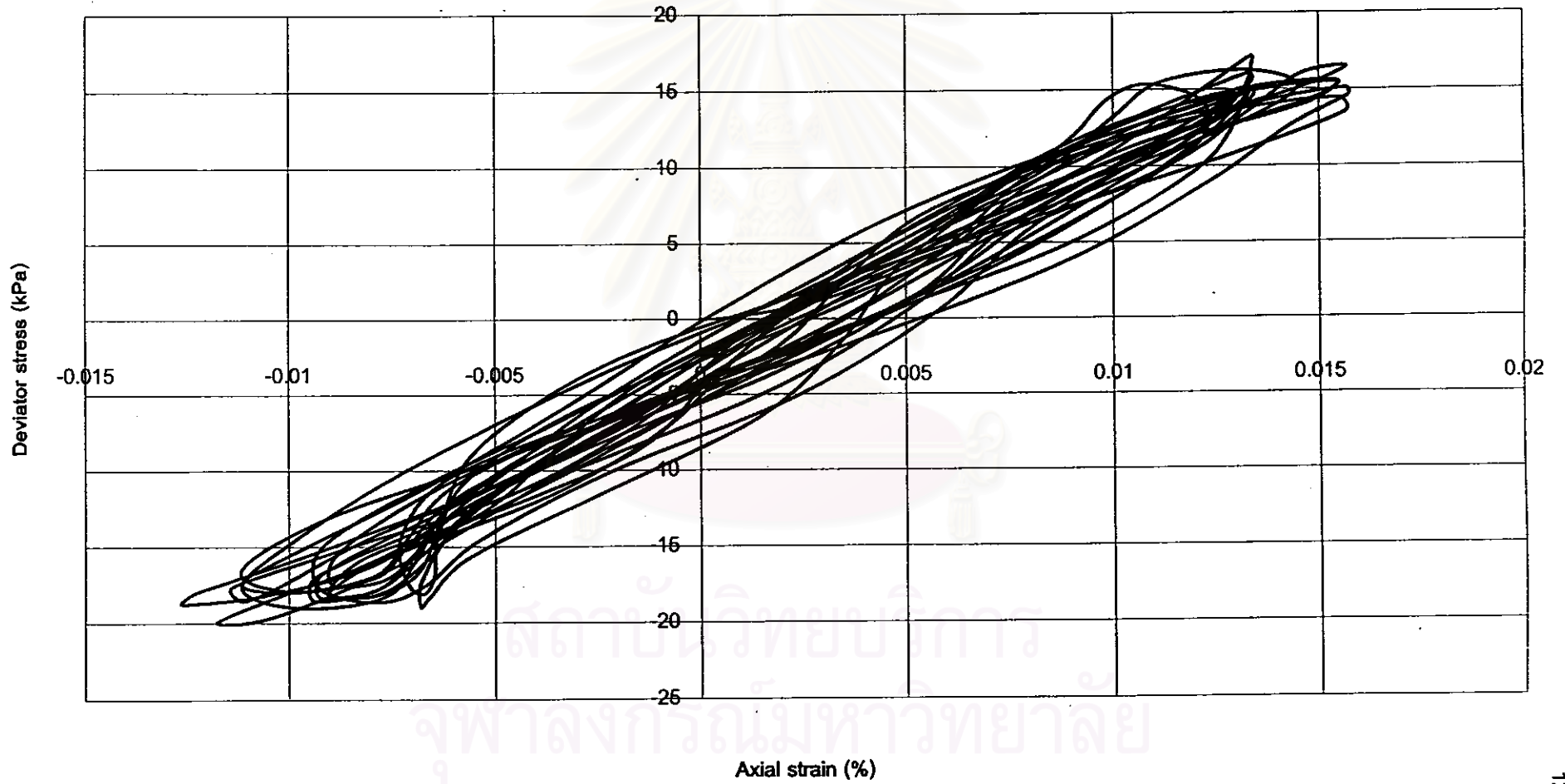

MU/250/90/0.10/1

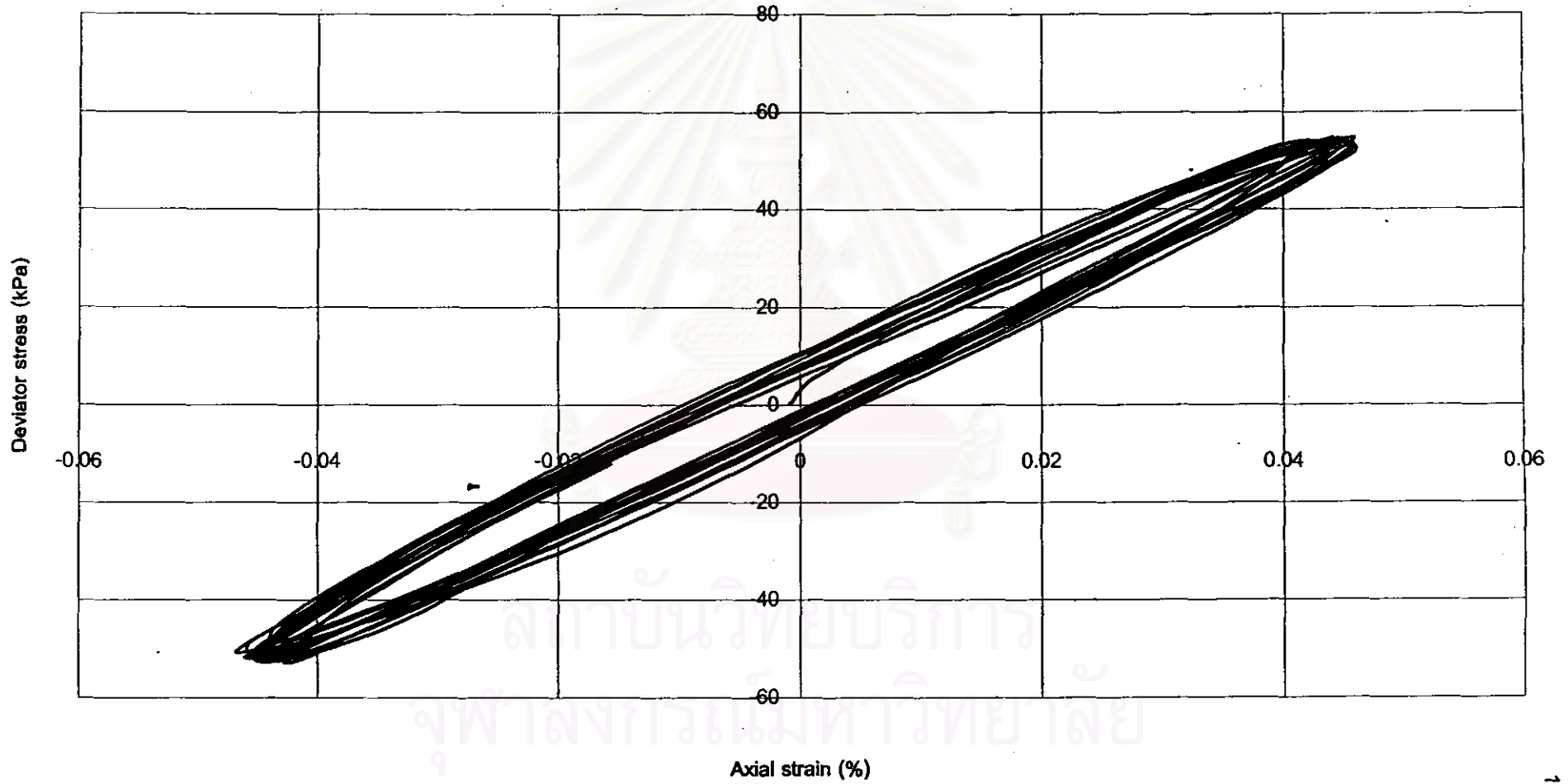

MU/200/250/0.10/1

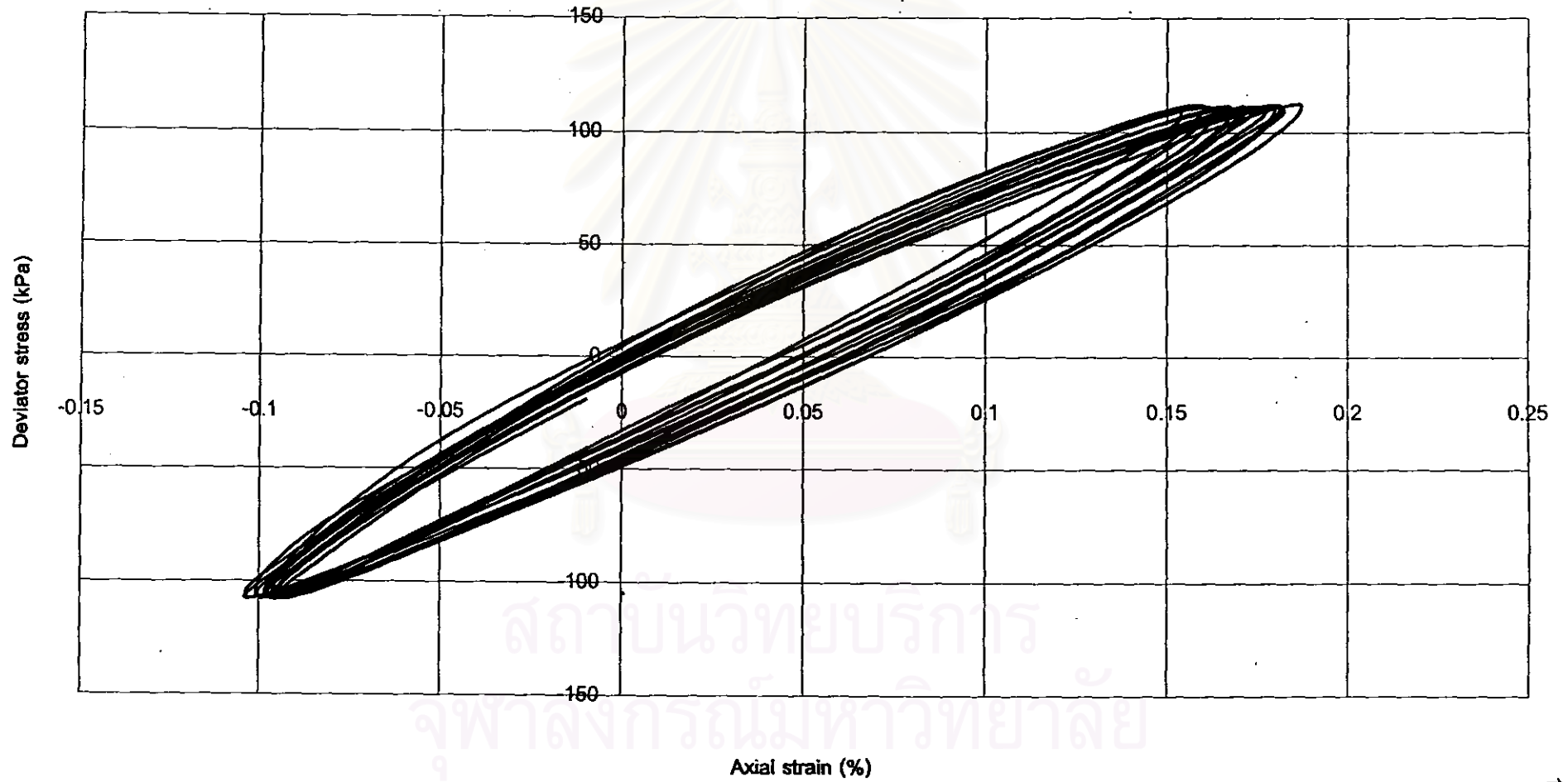

MU/60/250/0.10/2

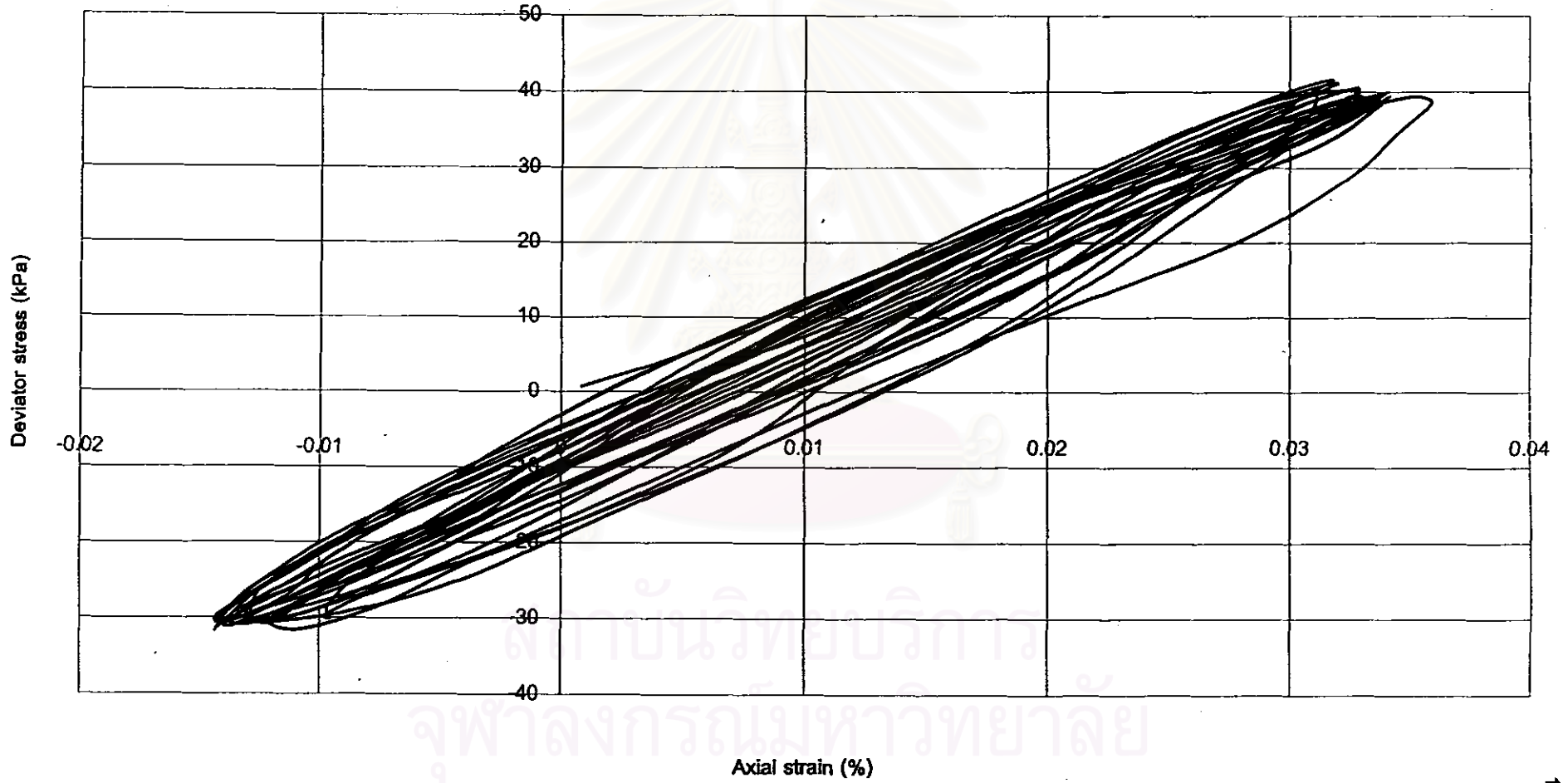

MU/250/250/0.10/2

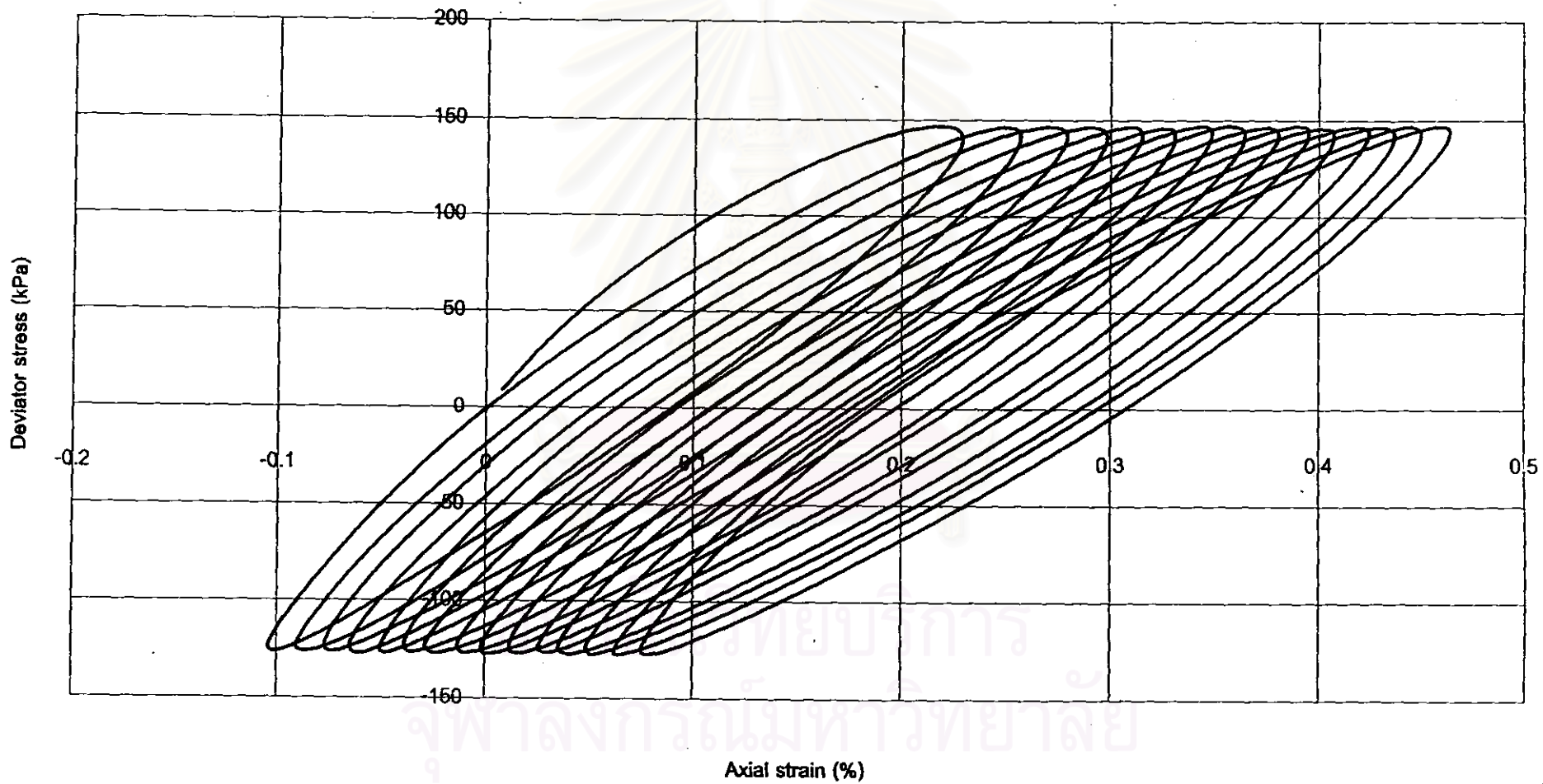

MU/30/250/1.0/1

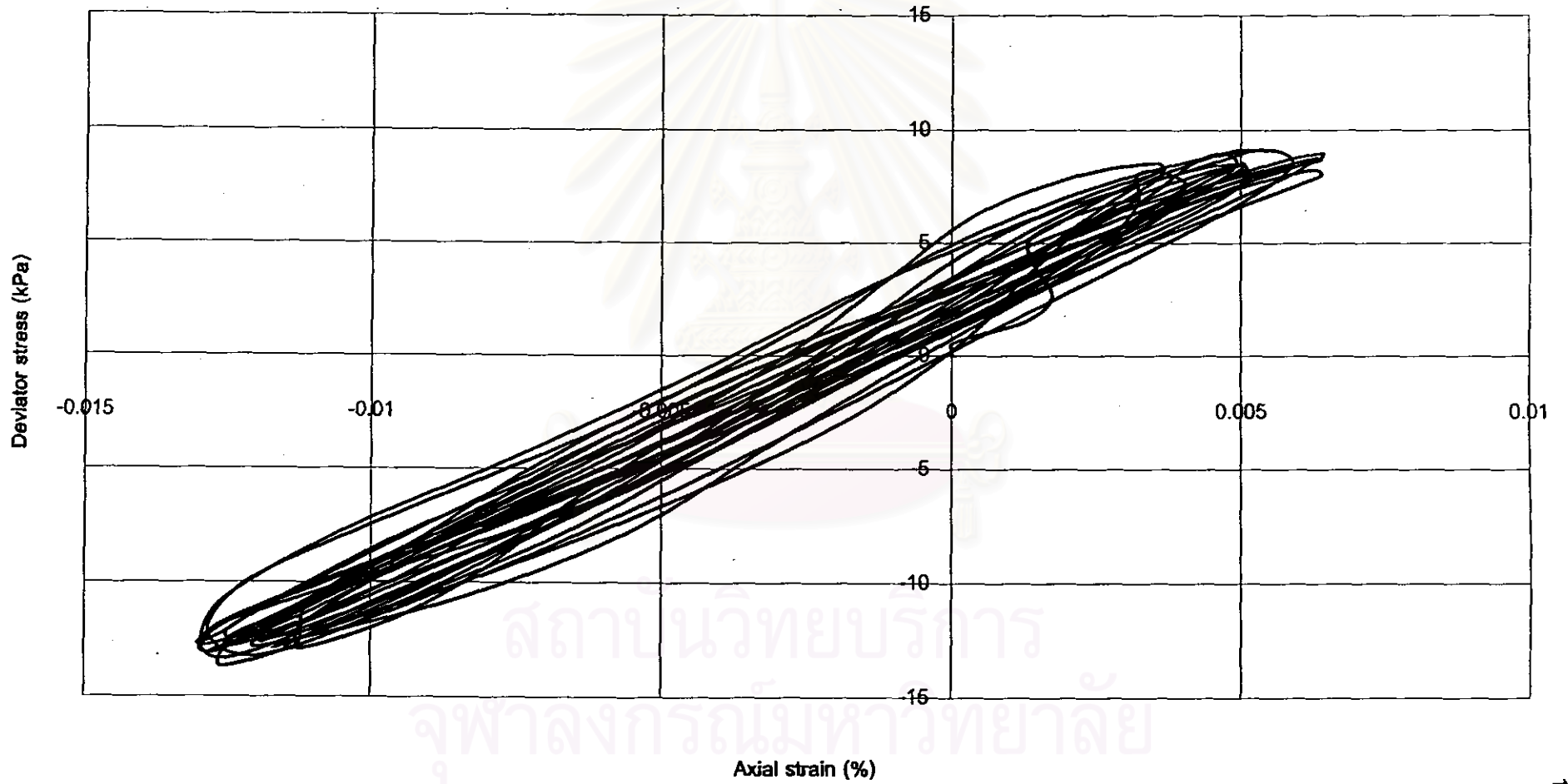

MU/90/250/1.0/2

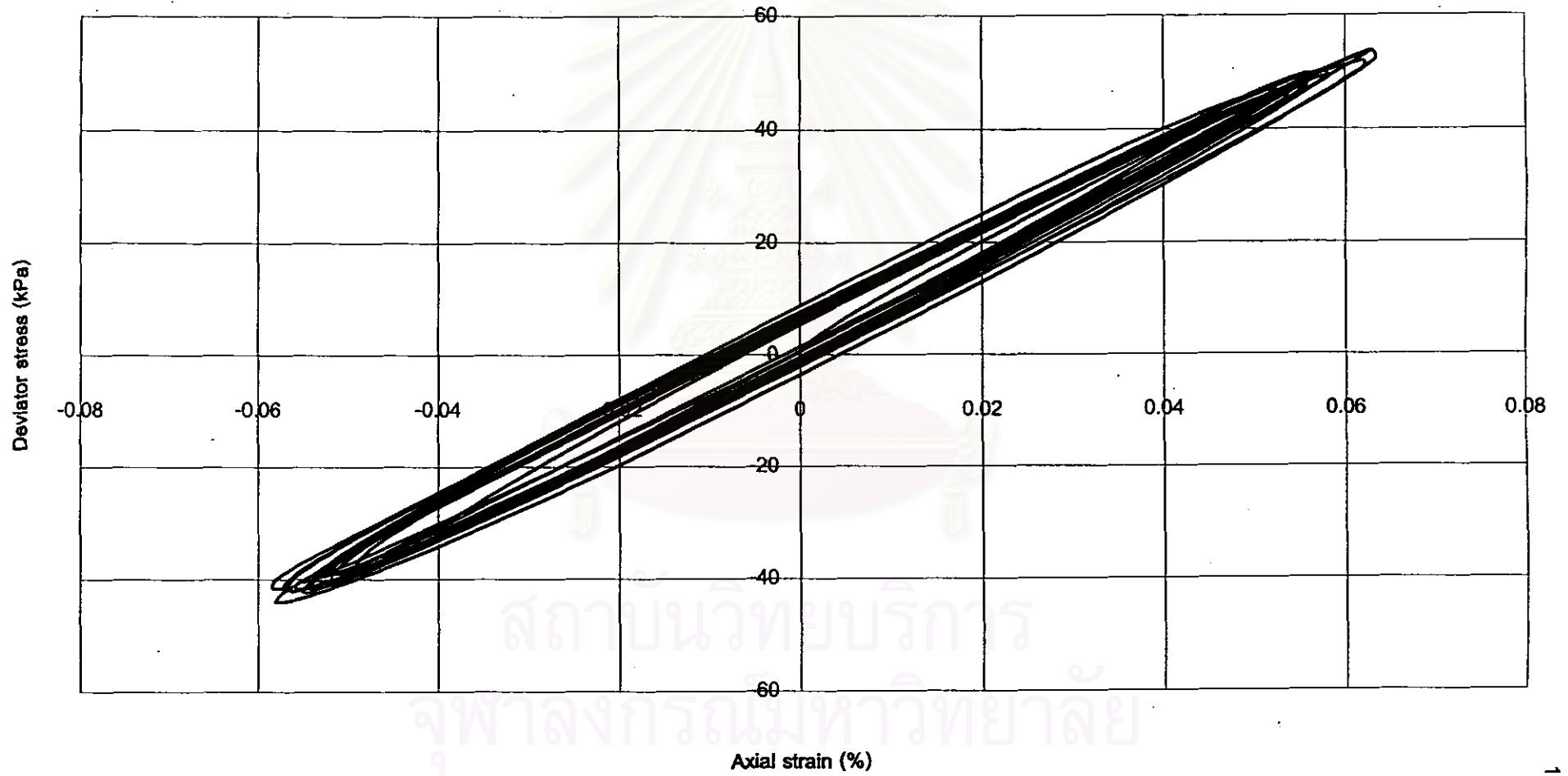

สถาบันวิทยบริการ
จุฬาลงกรณ์มหาวิทยาลัย

MU/250/220/1.0/3

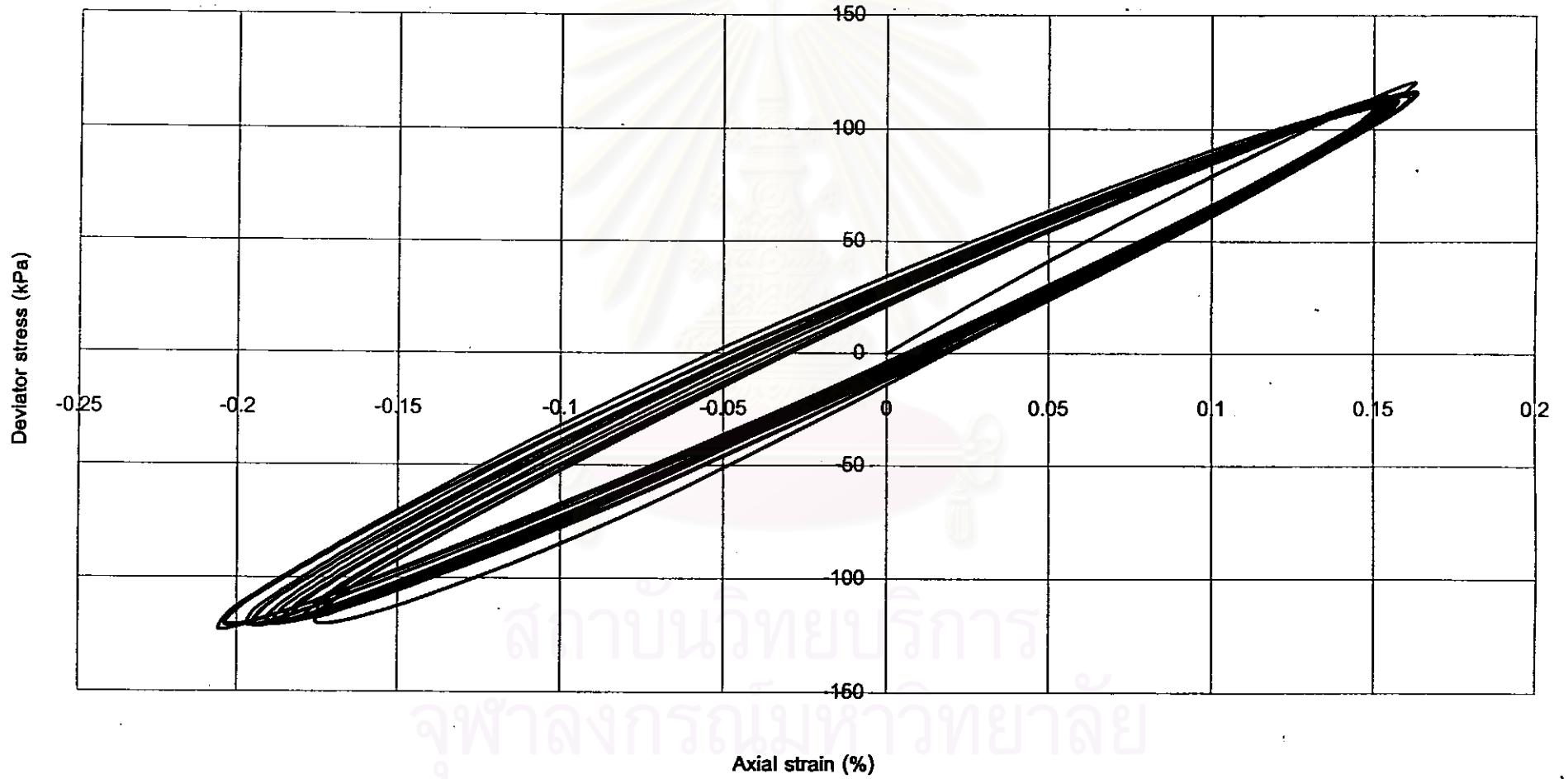

สถาบันวิทยบริการ
จุฬาลงกรณ์มหาวิทยาลัย

MU/250/260/1.0/3

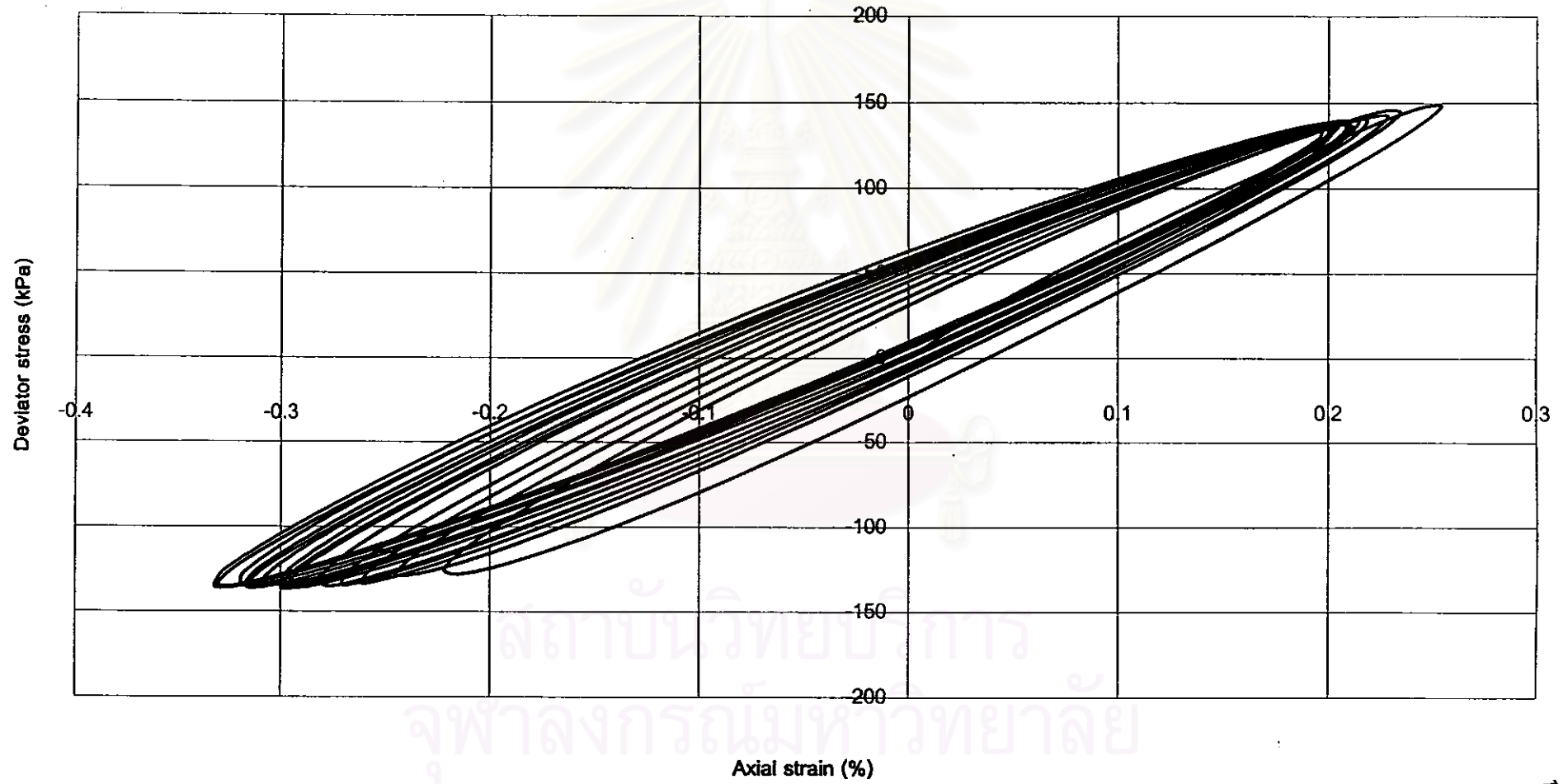

สถาบันวิทยบริการ
จุฬาลงกรณ์มหาวิทยาลัย



-ผลการทดสอบของตัวอย่างดินมหาวิทยาลัยเกษตรศาสตร์

สถาบันวิทยบริการ
จุฬาลงกรณ์มหาวิทยาลัย

KU/15/60/0.10/1

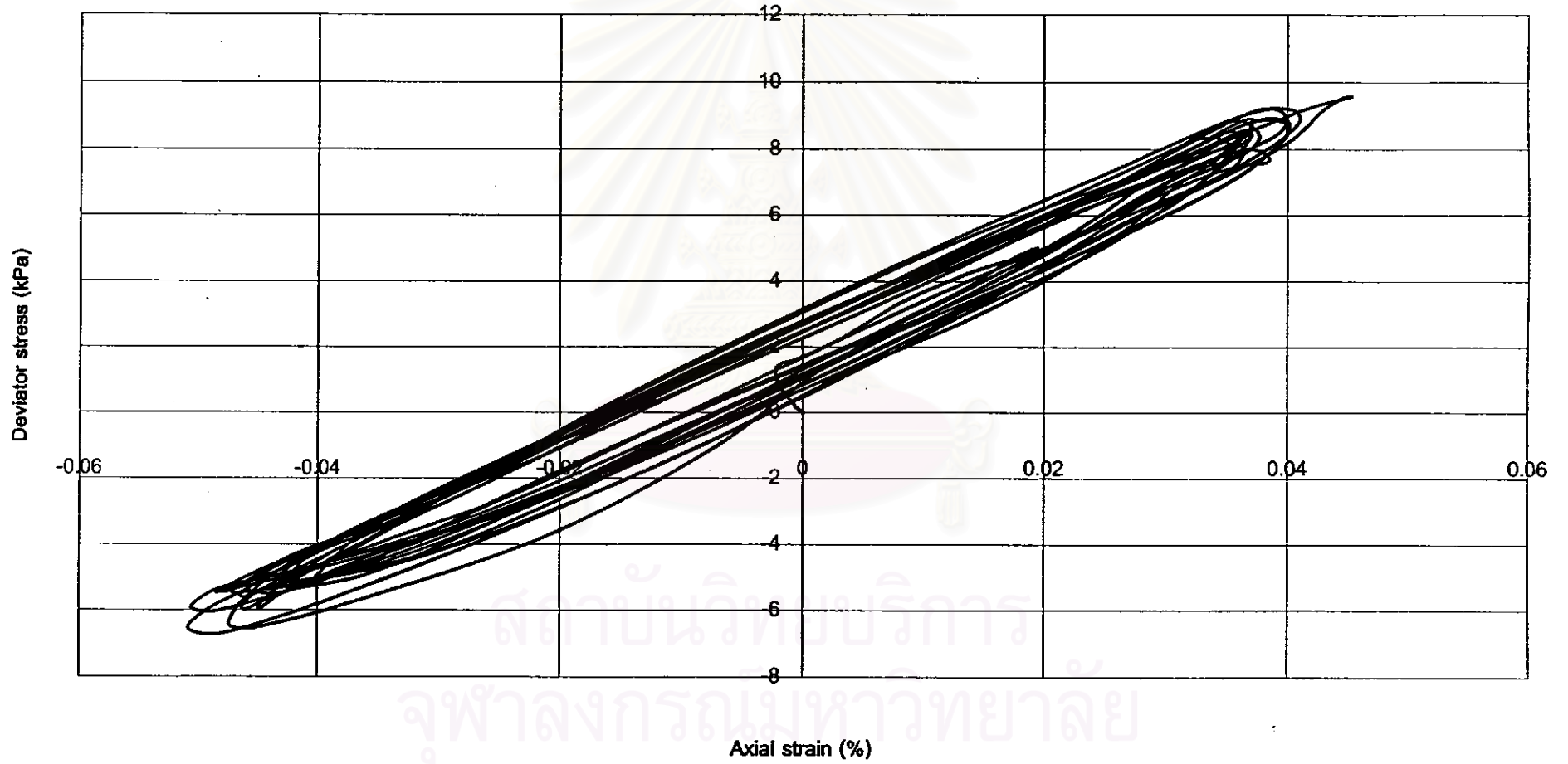

สถาบันวิทยบริการ
จุฬาลงกรณ์มหาวิทยาลัย

KU/20/60/0.10/1

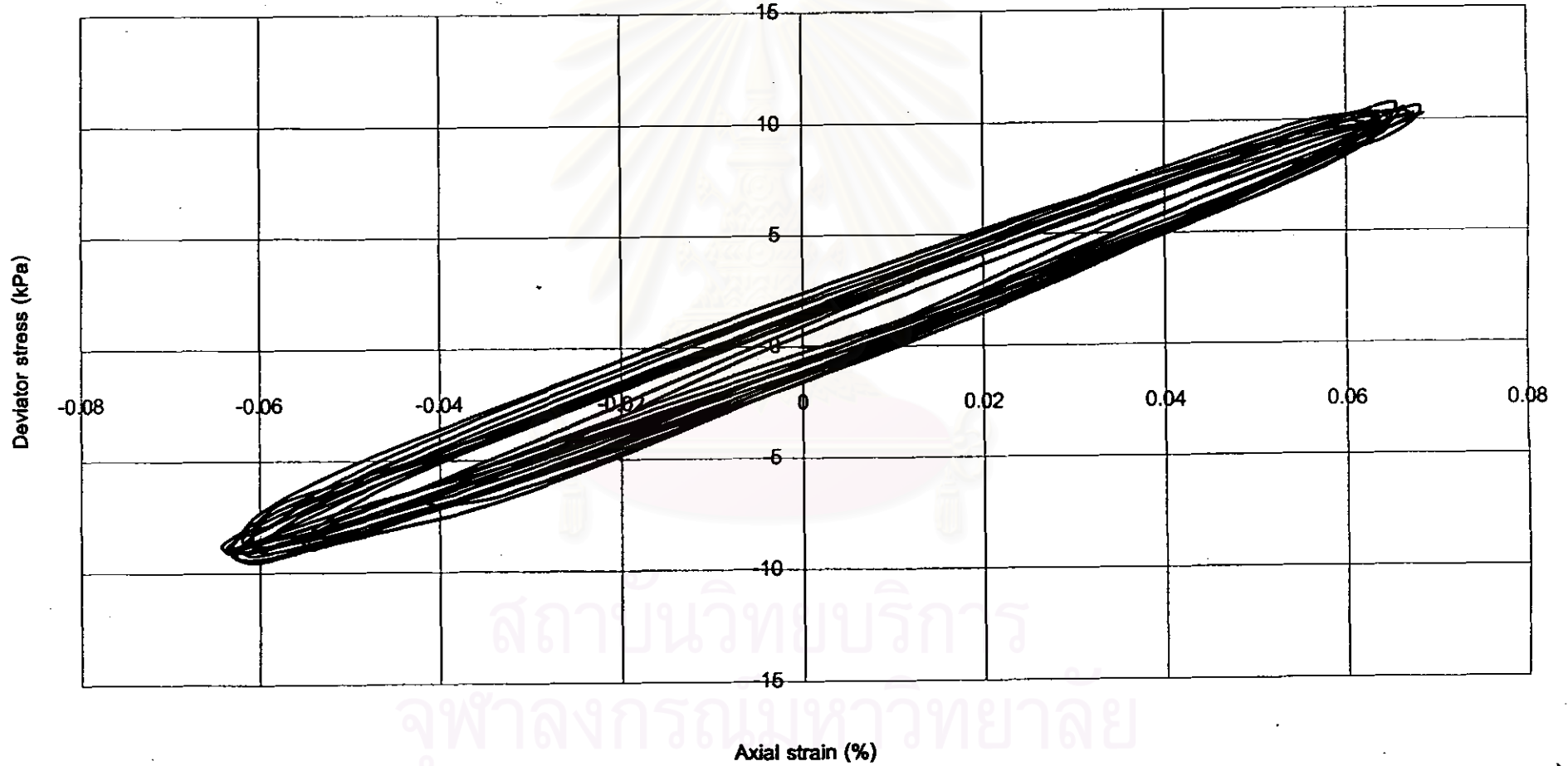

สถาบันวิทยบริการ
จุฬาลงกรณ์มหาวิทยาลัย

KU/15/60/0.10/2

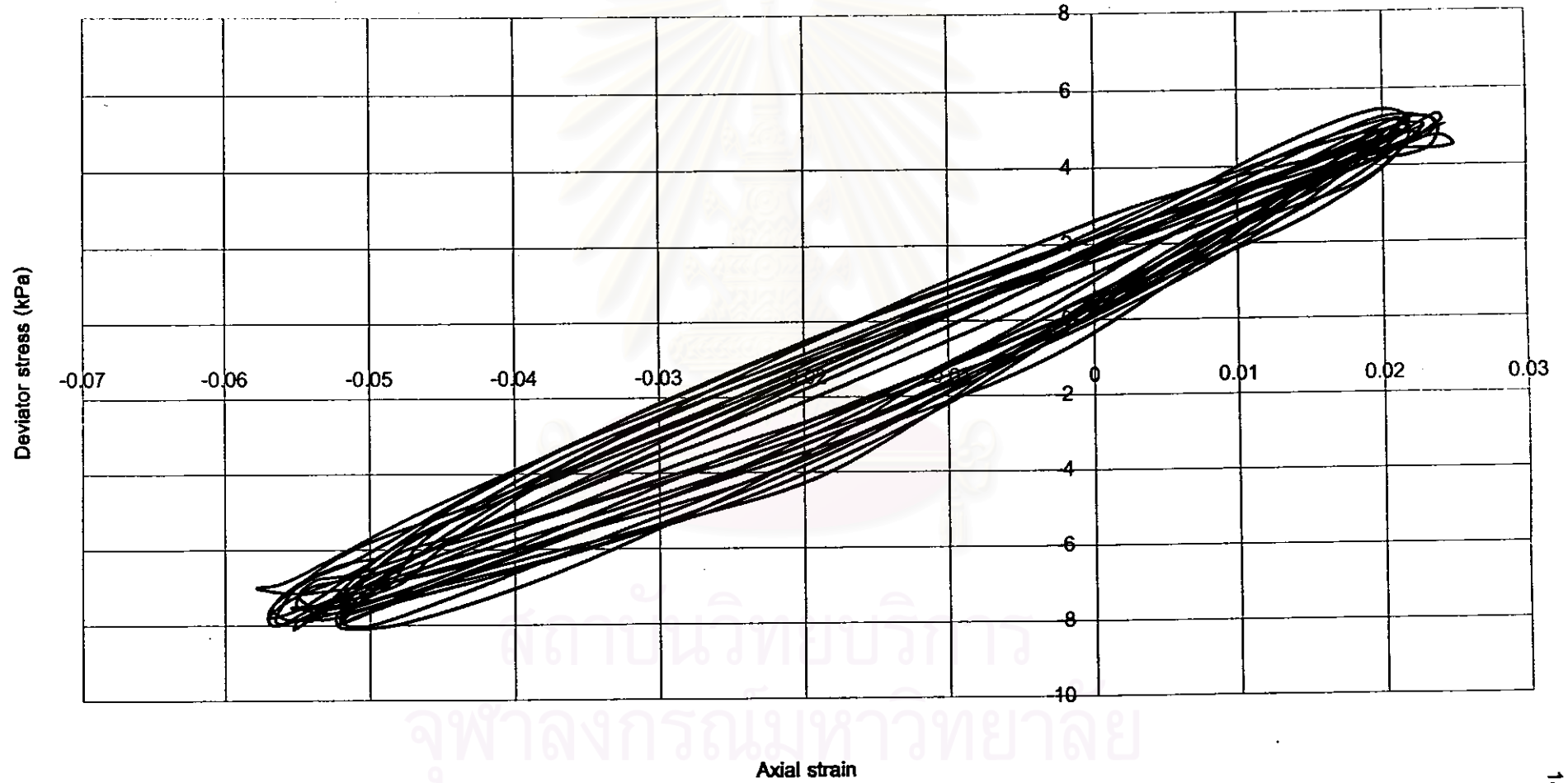

ศูนย์วิจัยบริการ
จุฬาลงกรณ์มหาวิทยาลัย

KU/40/60/0.10/2

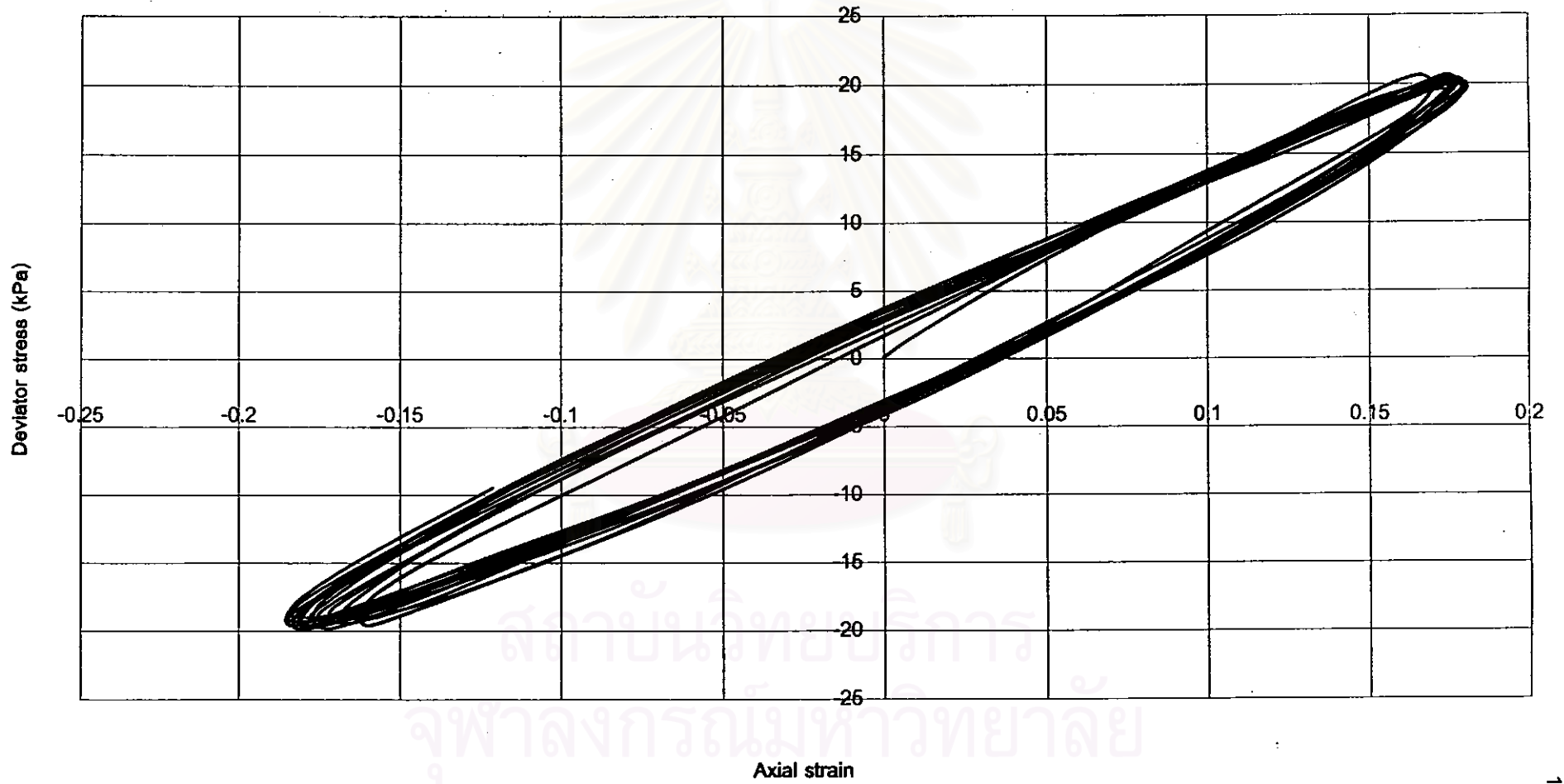

สถาบันวิทยบริการ
จุฬาลงกรณ์มหาวิทยาลัย

KU/45/60/0.10/2

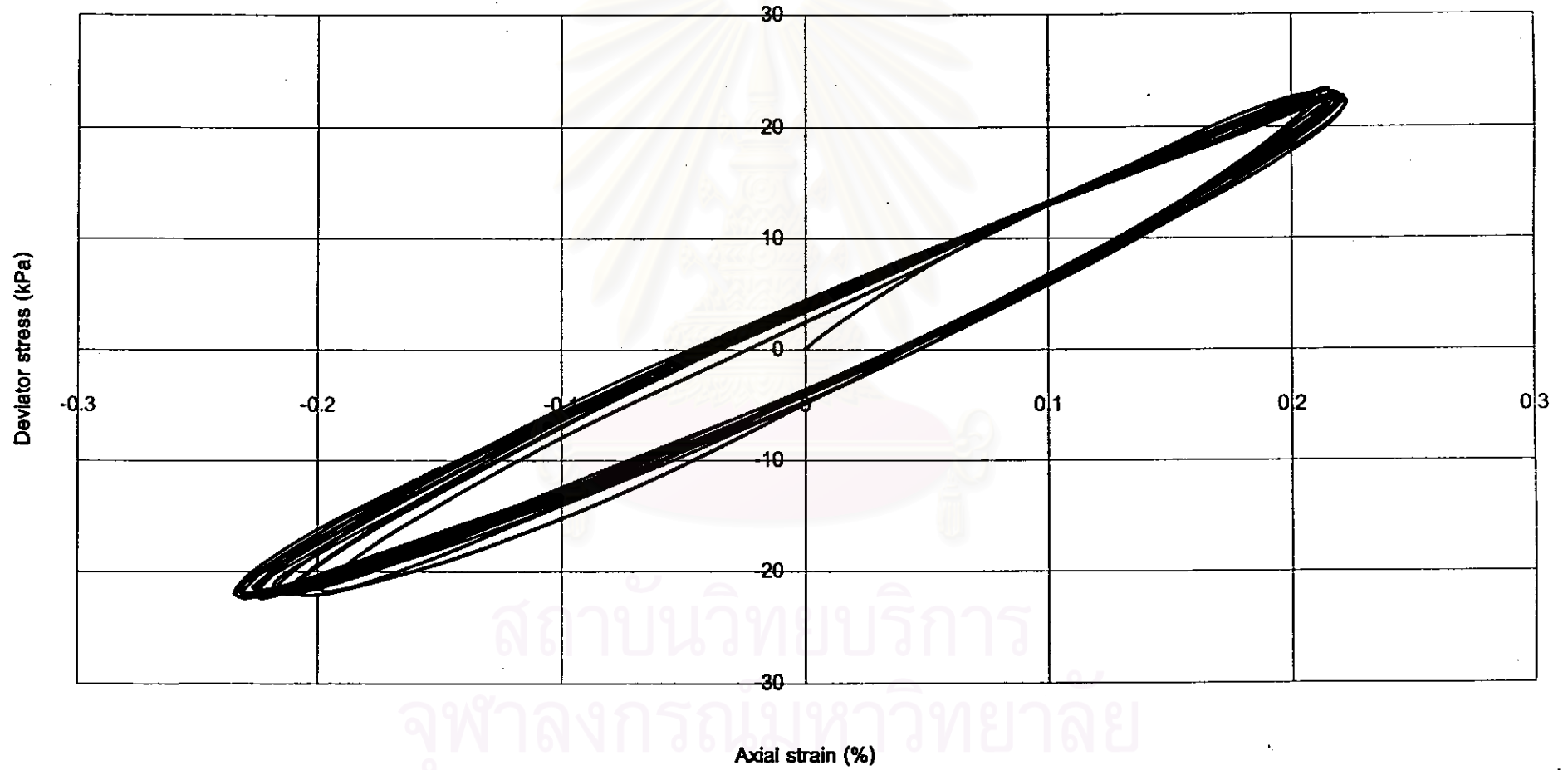

สถาบันวิทยบริการ
จุฬาลงกรณ์มหาวิทยาลัย

KU/20/60/0.10/3

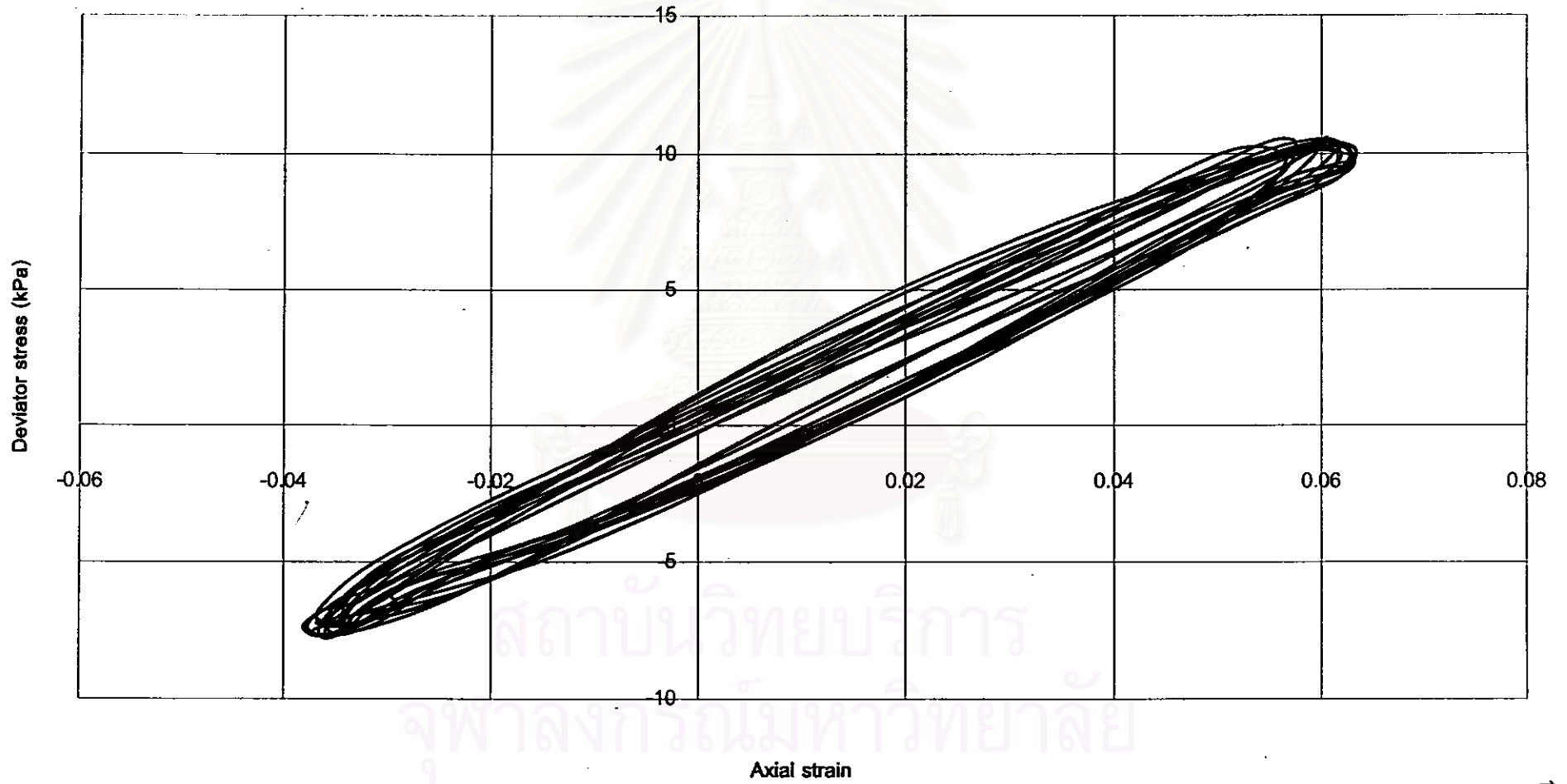

KU/90/60/0.10/3

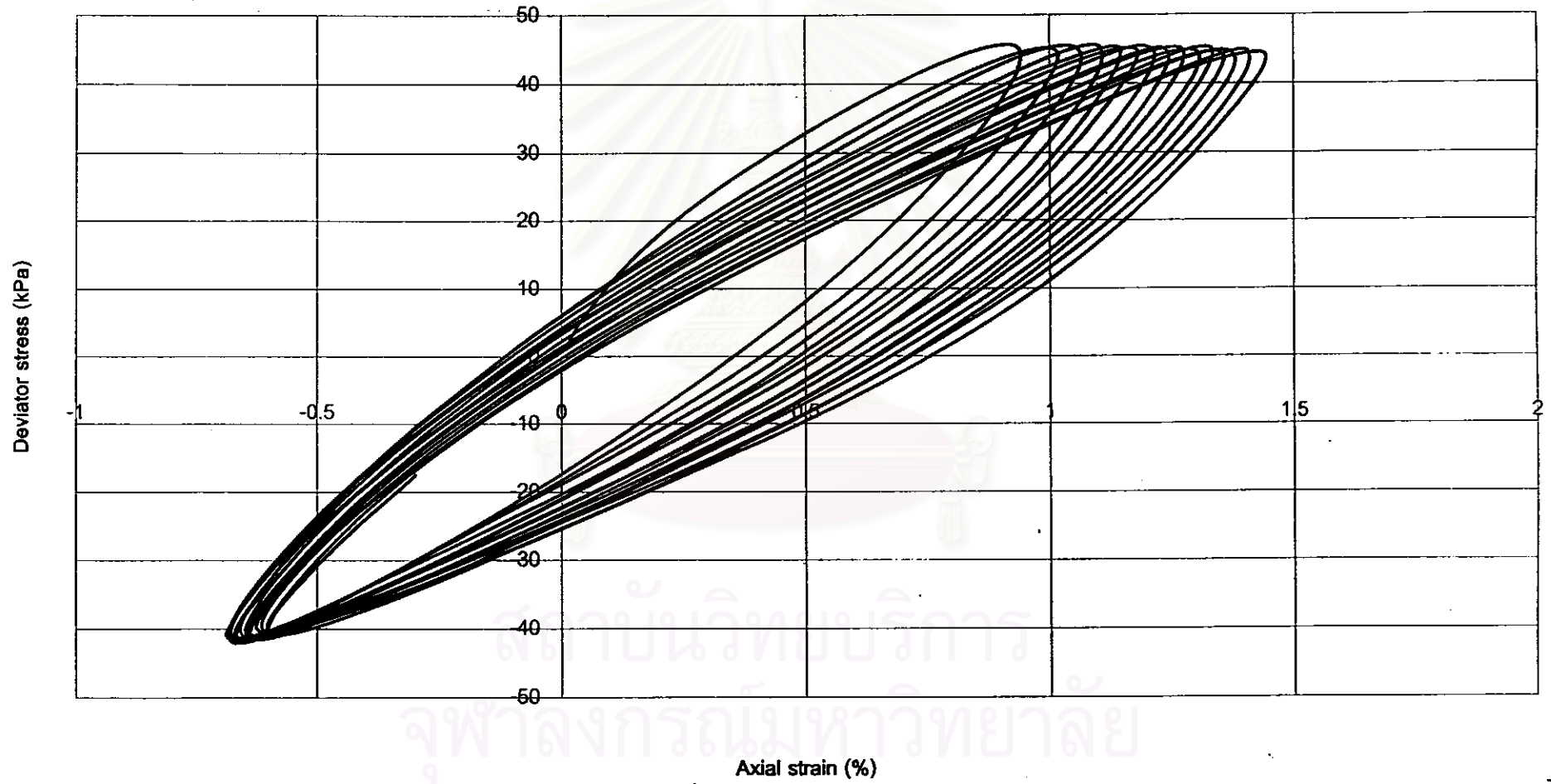

KU/110/60/0.10/3

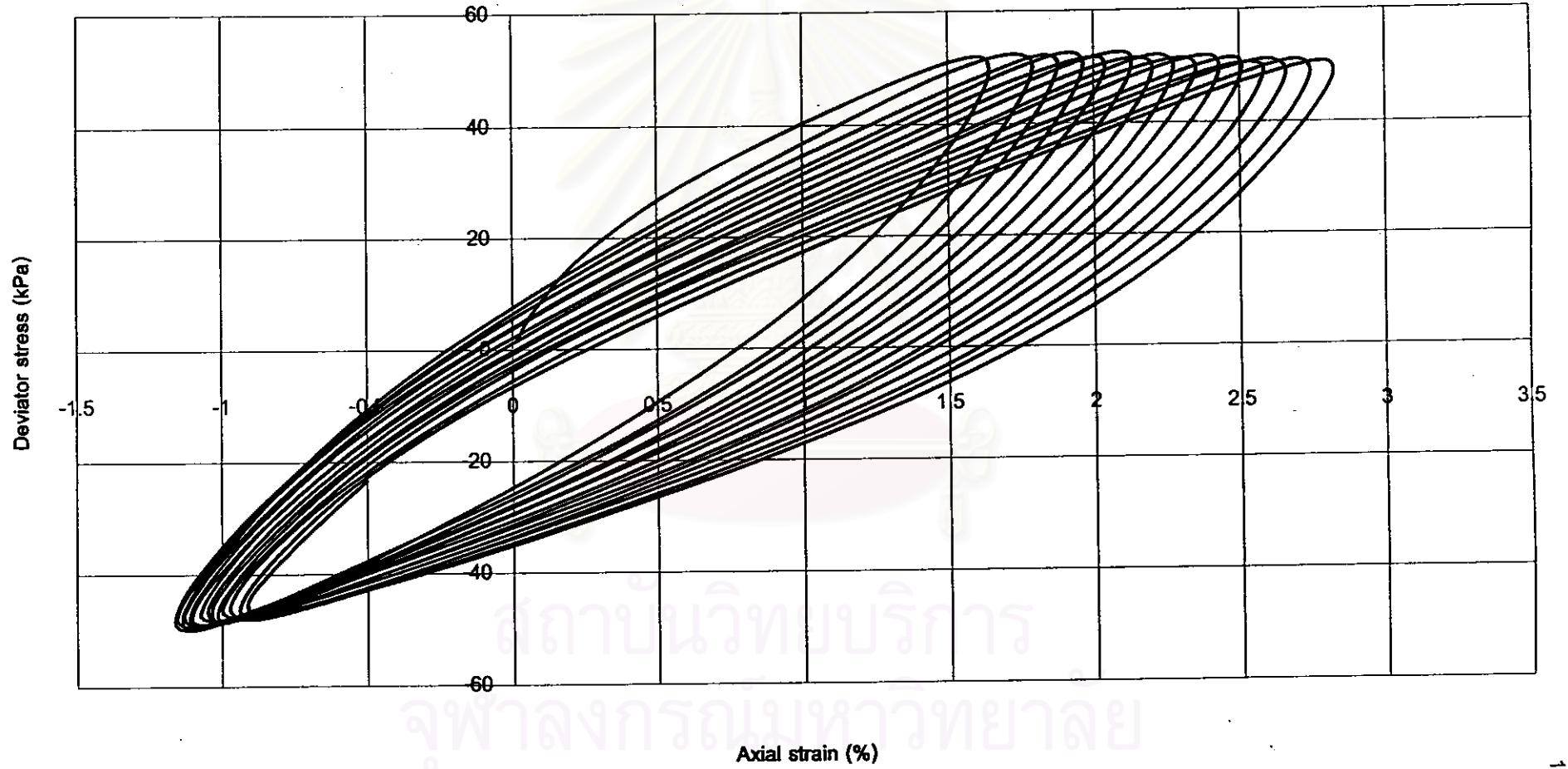

KU/120/60/0.10/3

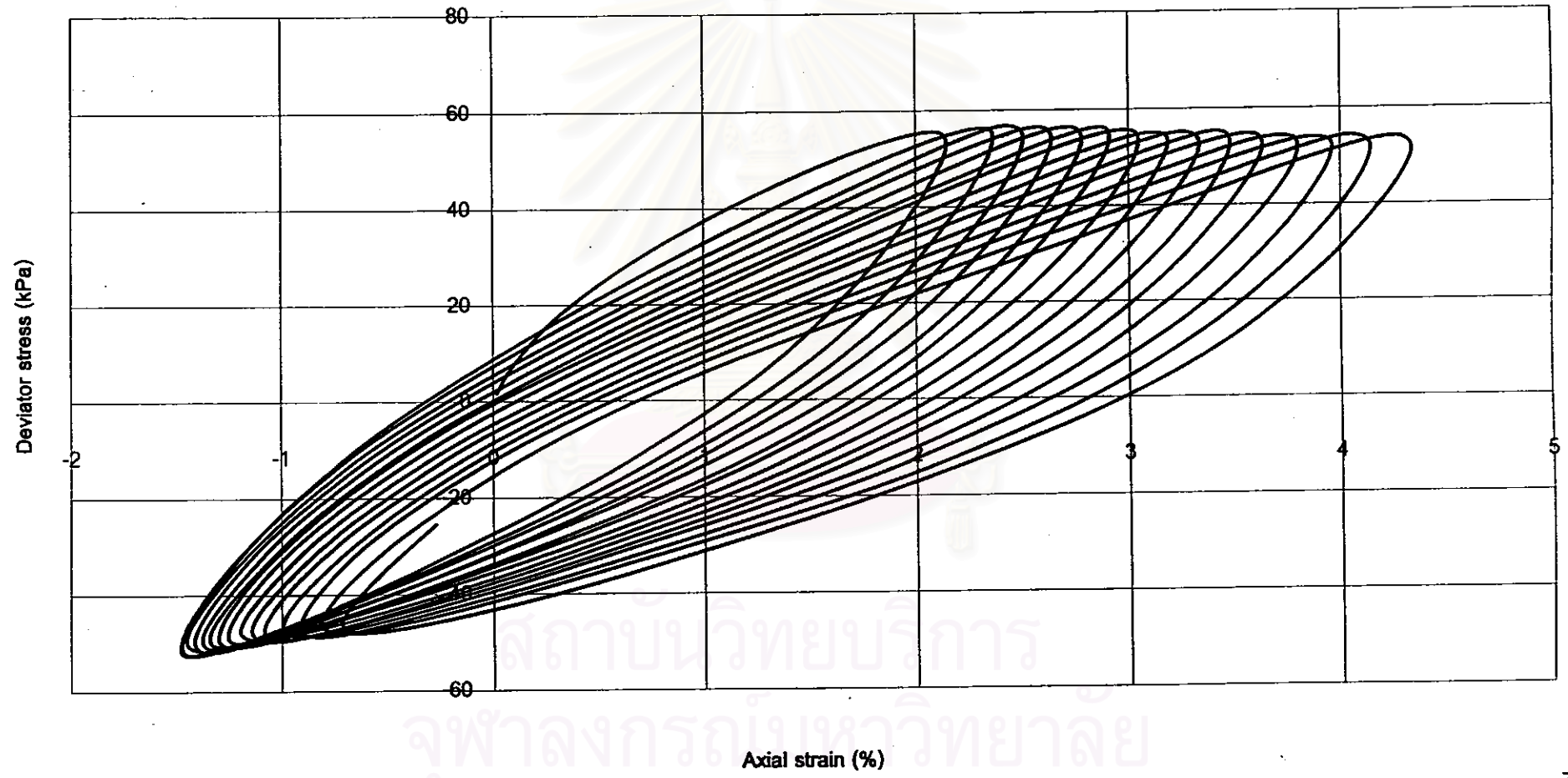

สถาบันวิทยบริการ
จุฬาลงกรณ์มหาวิทยาลัย

KU/20/60/1.0/1

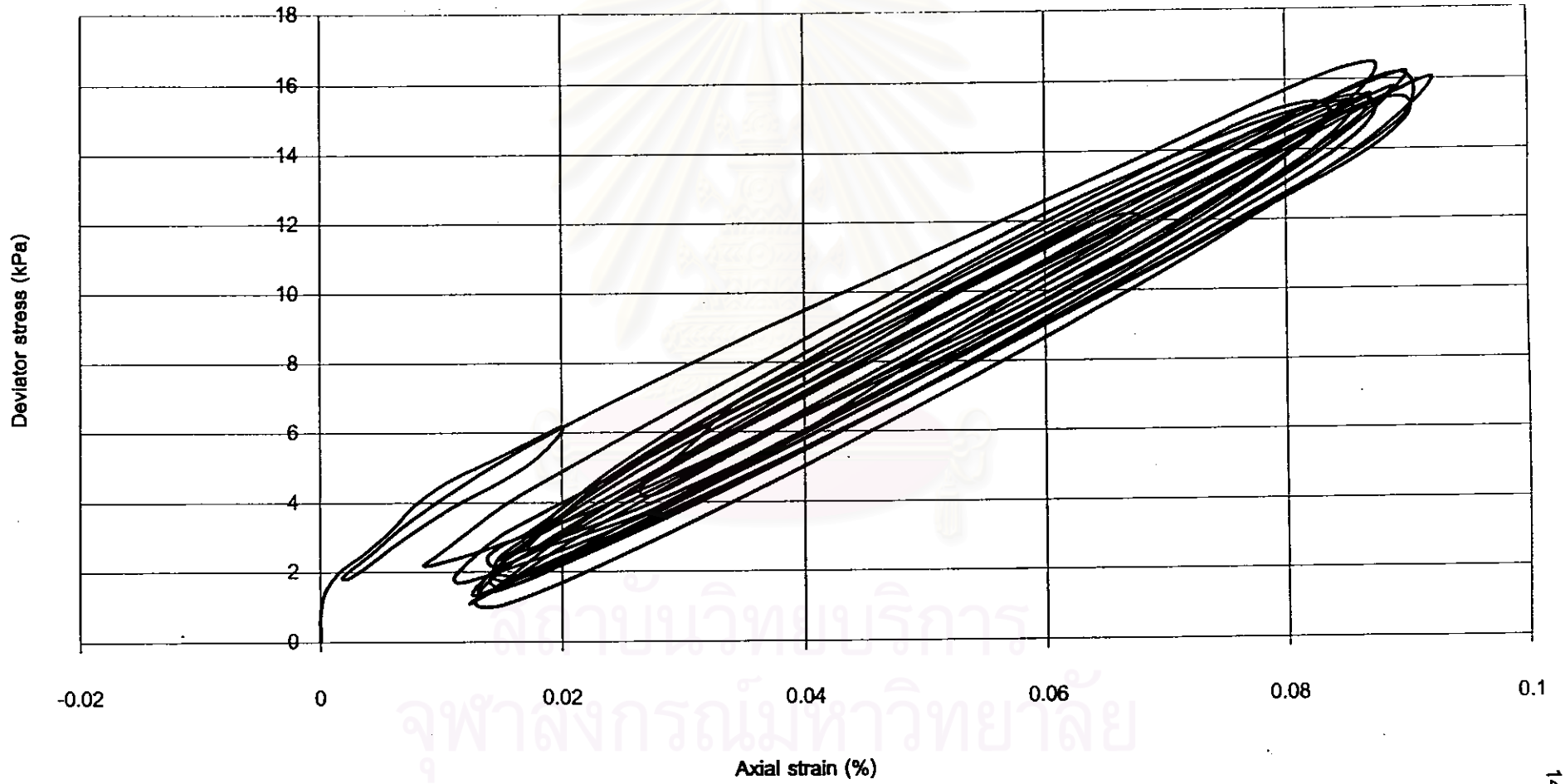

KU/40/60/1.0/2



สถาบันทบบริการ
จุฬาลงกรณ์มหาวิทยาลัย

KU/20/60/1.0/3

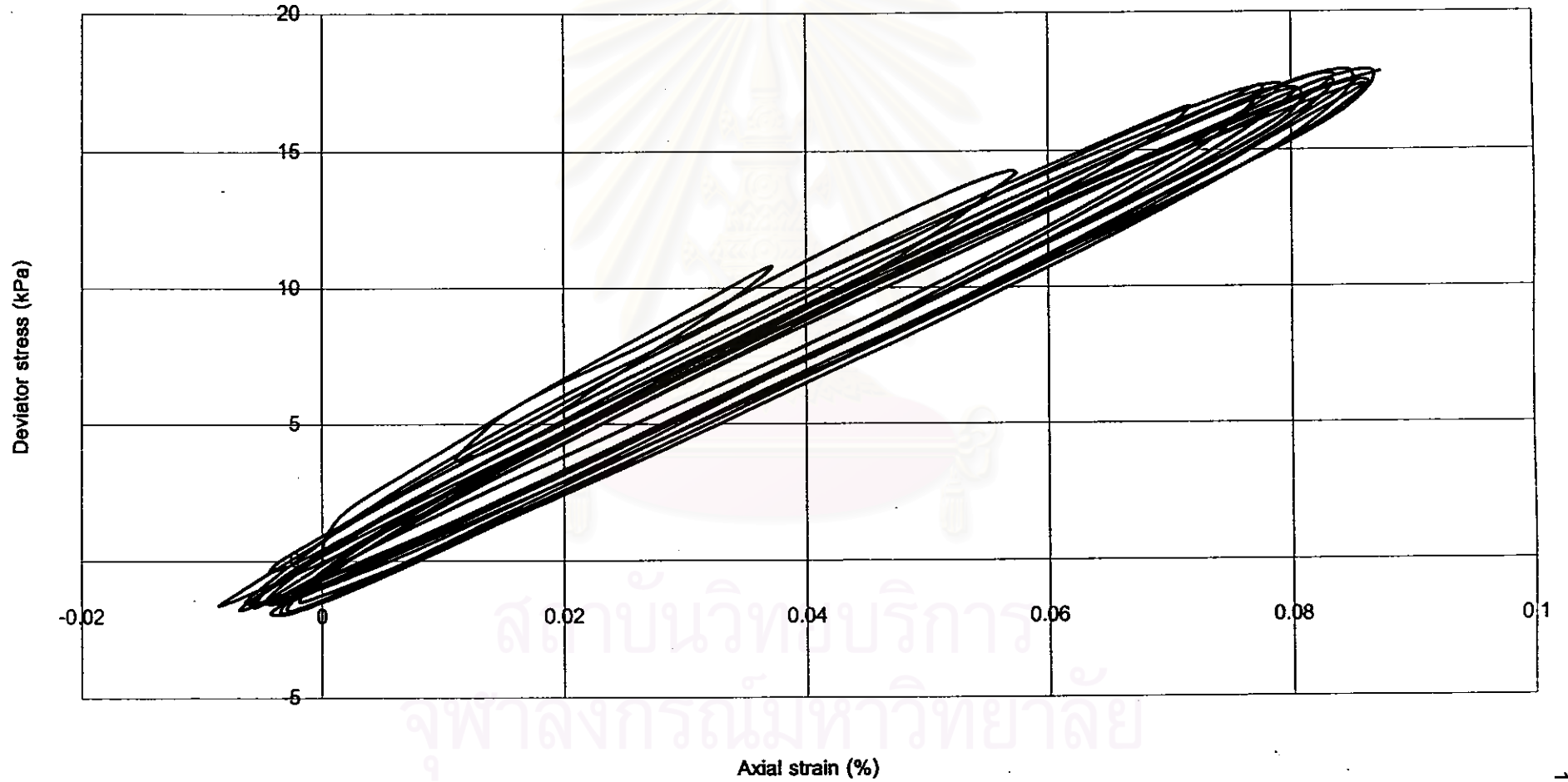

KU/110/60/1.0/3



KU/130/60/1.0/3

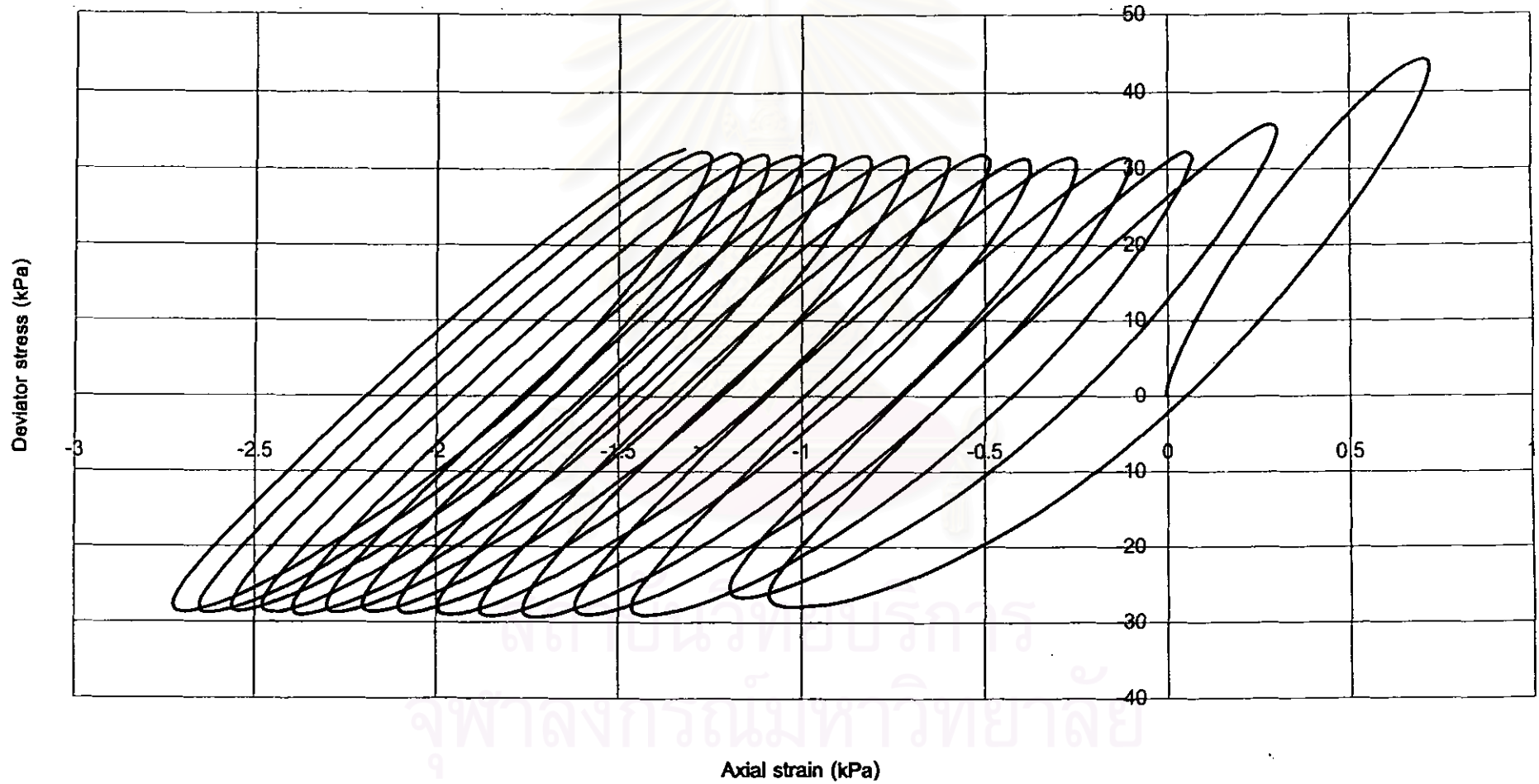

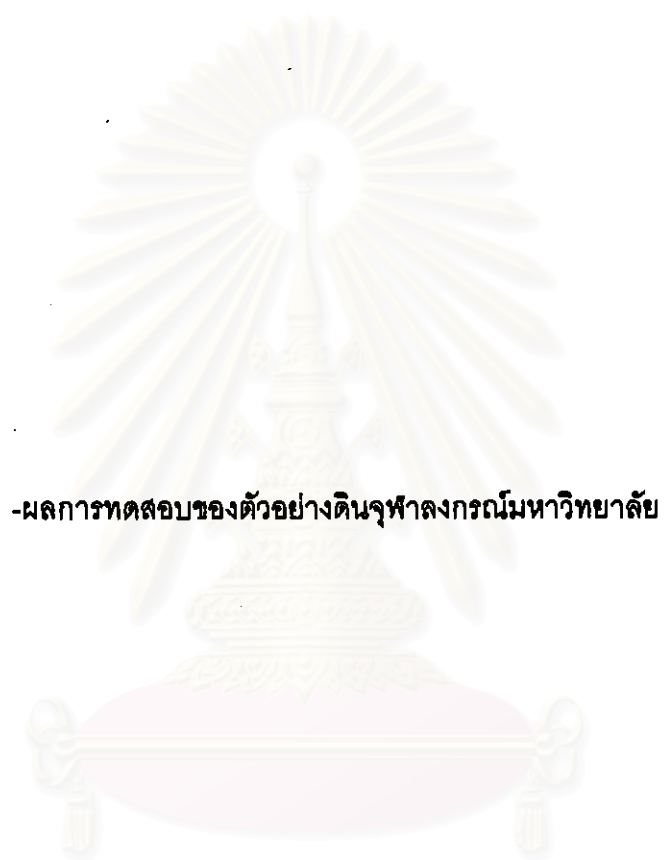

-ผลการทดสอบของตัวอย่างดินจุฬาลงกรณ์มหาวิทยาลัย

สถาบันวิทยบริการ
จุฬาลงกรณ์มหาวิทยาลัย

CU/20/40/0.10/1

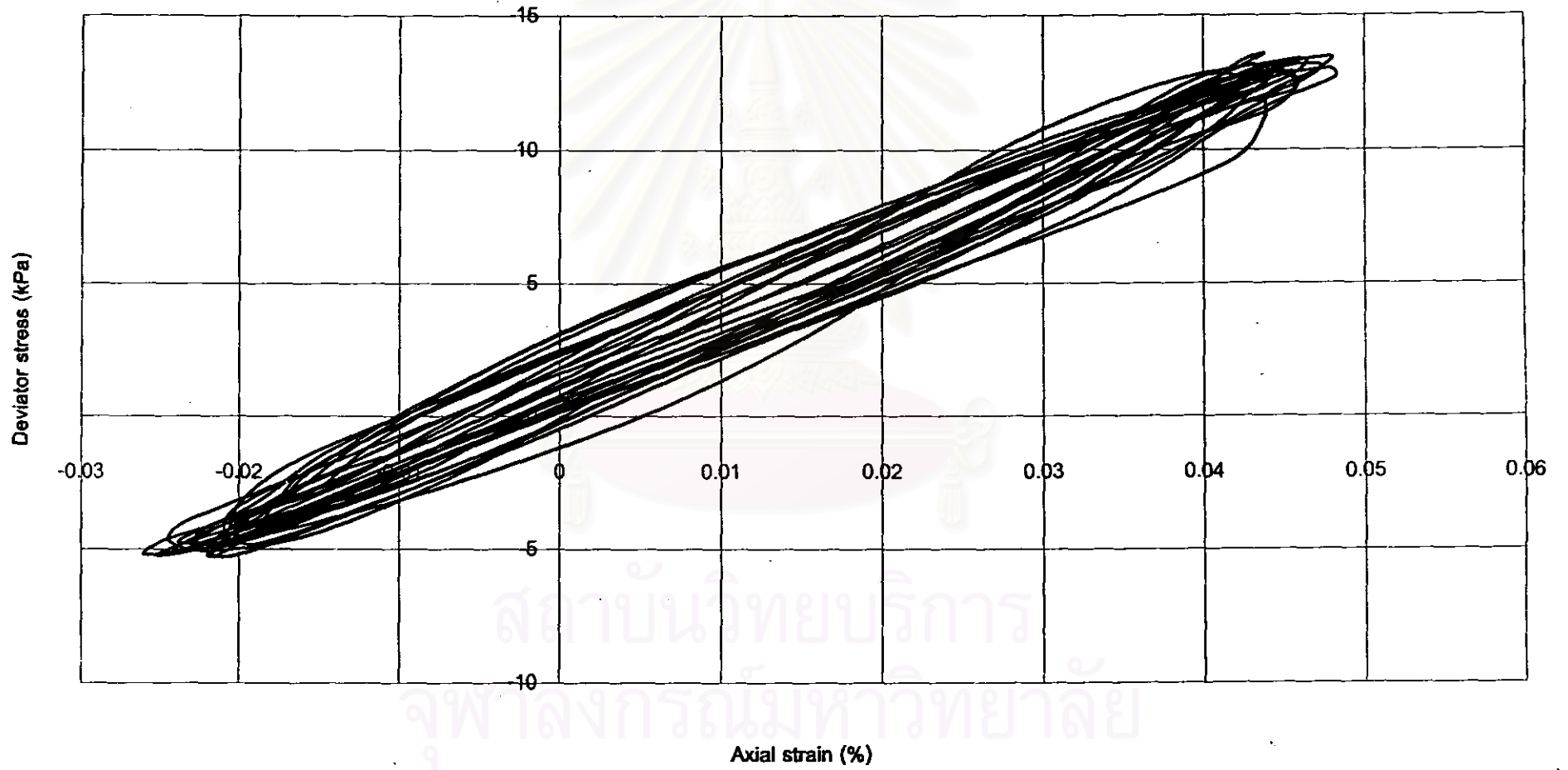

สถาบันวิทยบริการ
จุฬาลงกรณ์มหาวิทยาลัย

CU/25/40/0.10/1

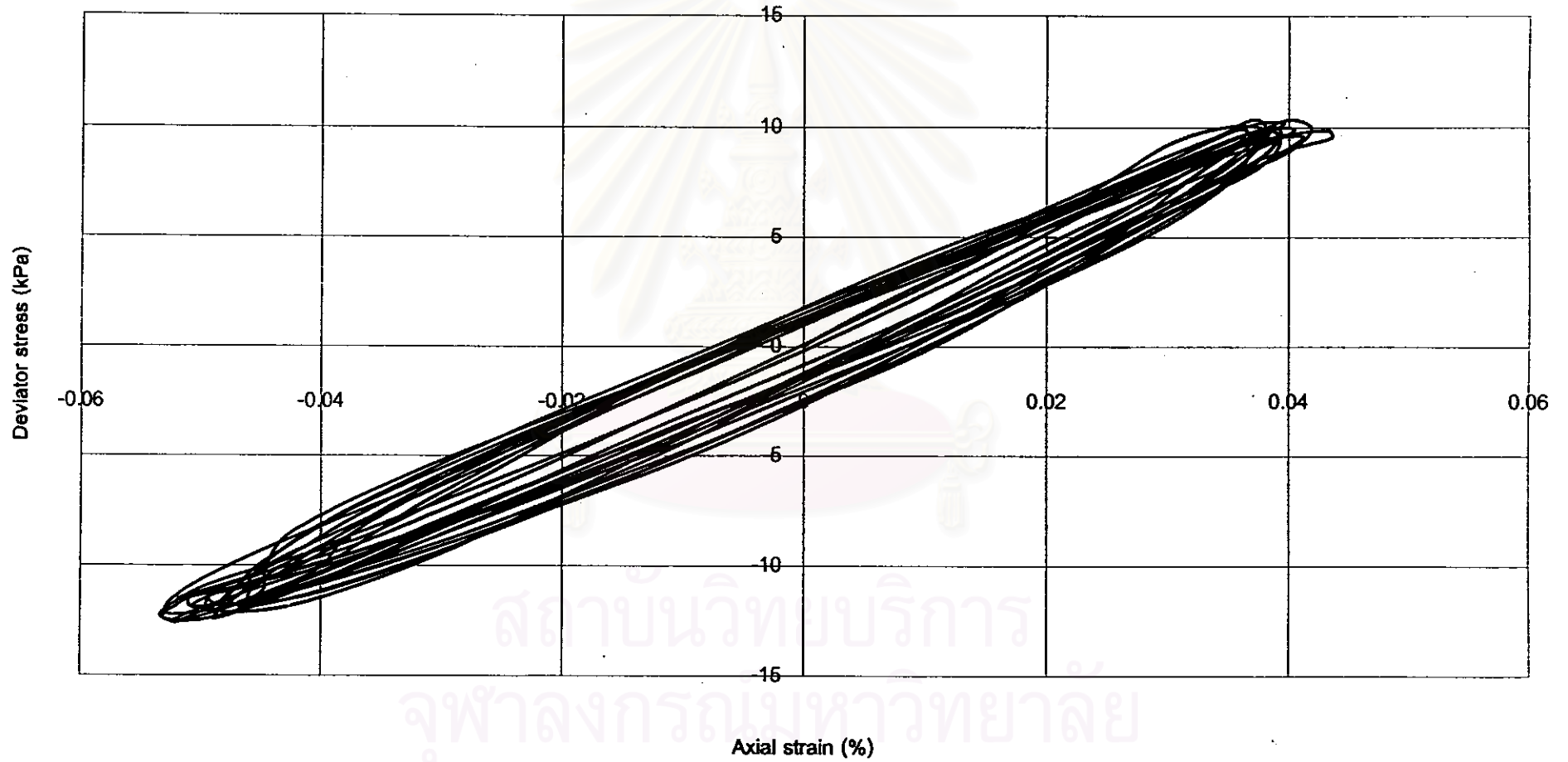

สถาบันวิทยบริการ
จุฬาลงกรณ์มหาวิทยาลัย

CU/30/40/0.10/1

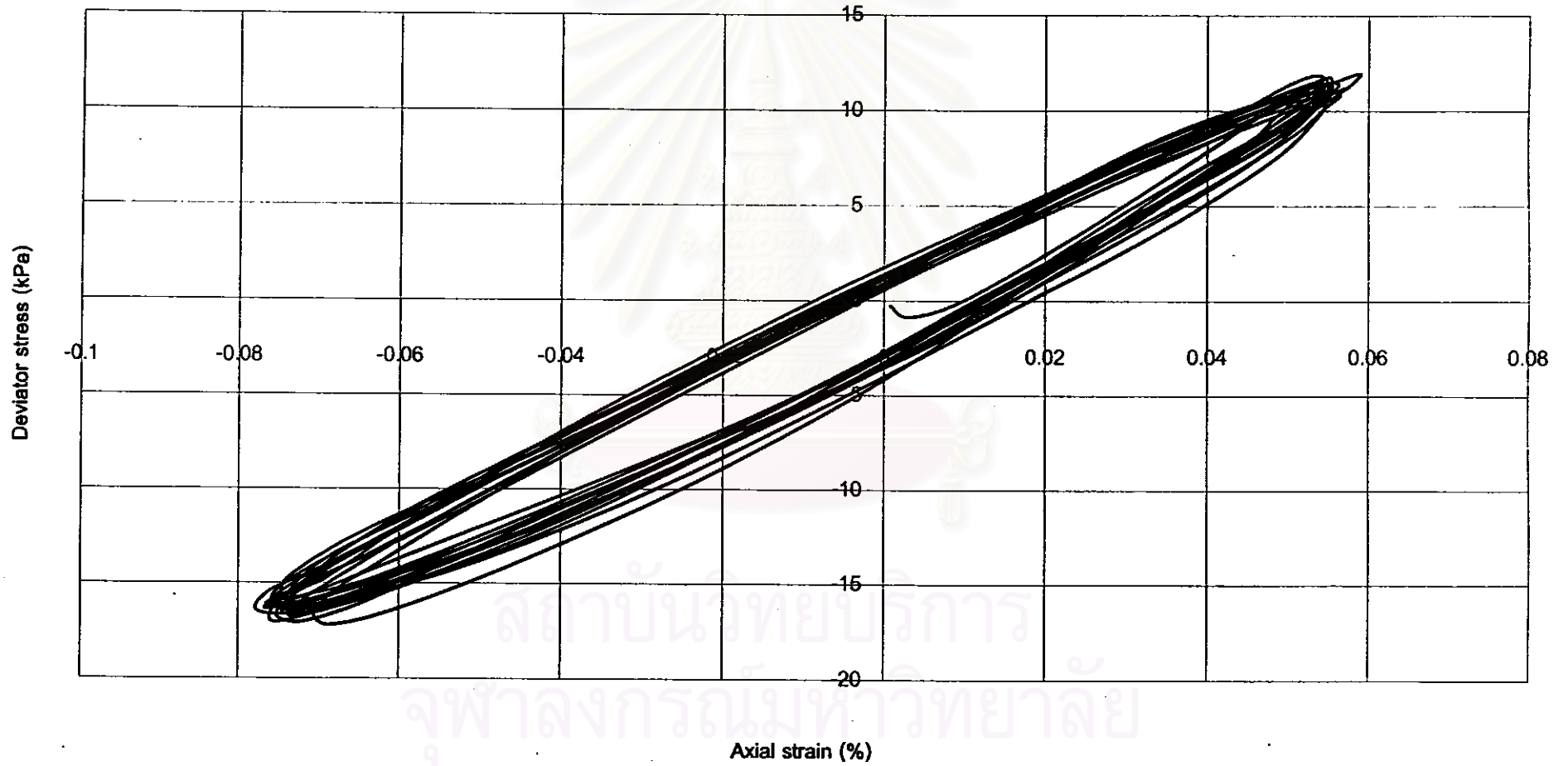

CU/35/40/0.10/1

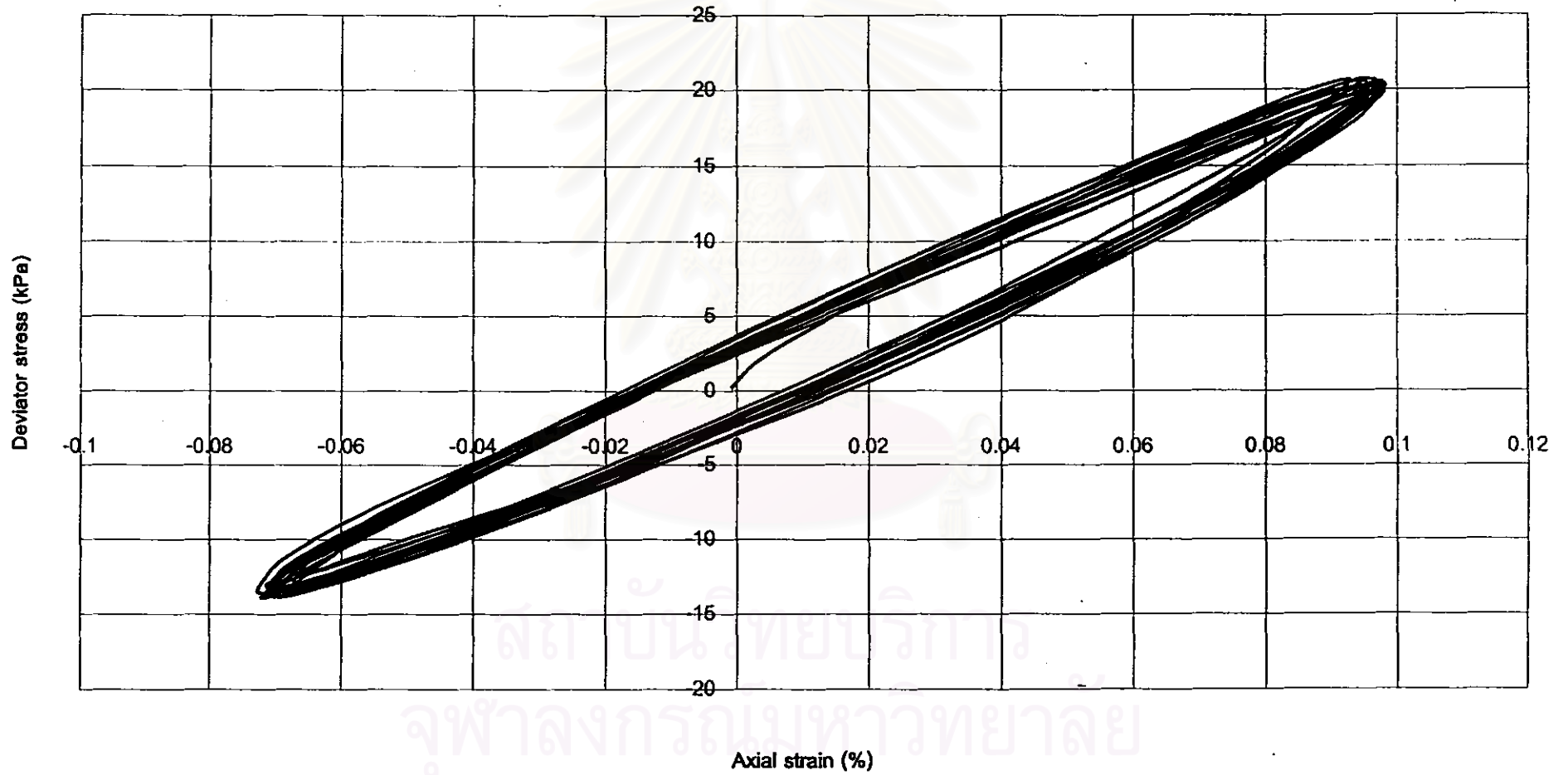

สถาบันเทคโนโลยีการ
จุฬาลงกรณ์มหาวิทยาลัย

CU/40/40/0.10/1

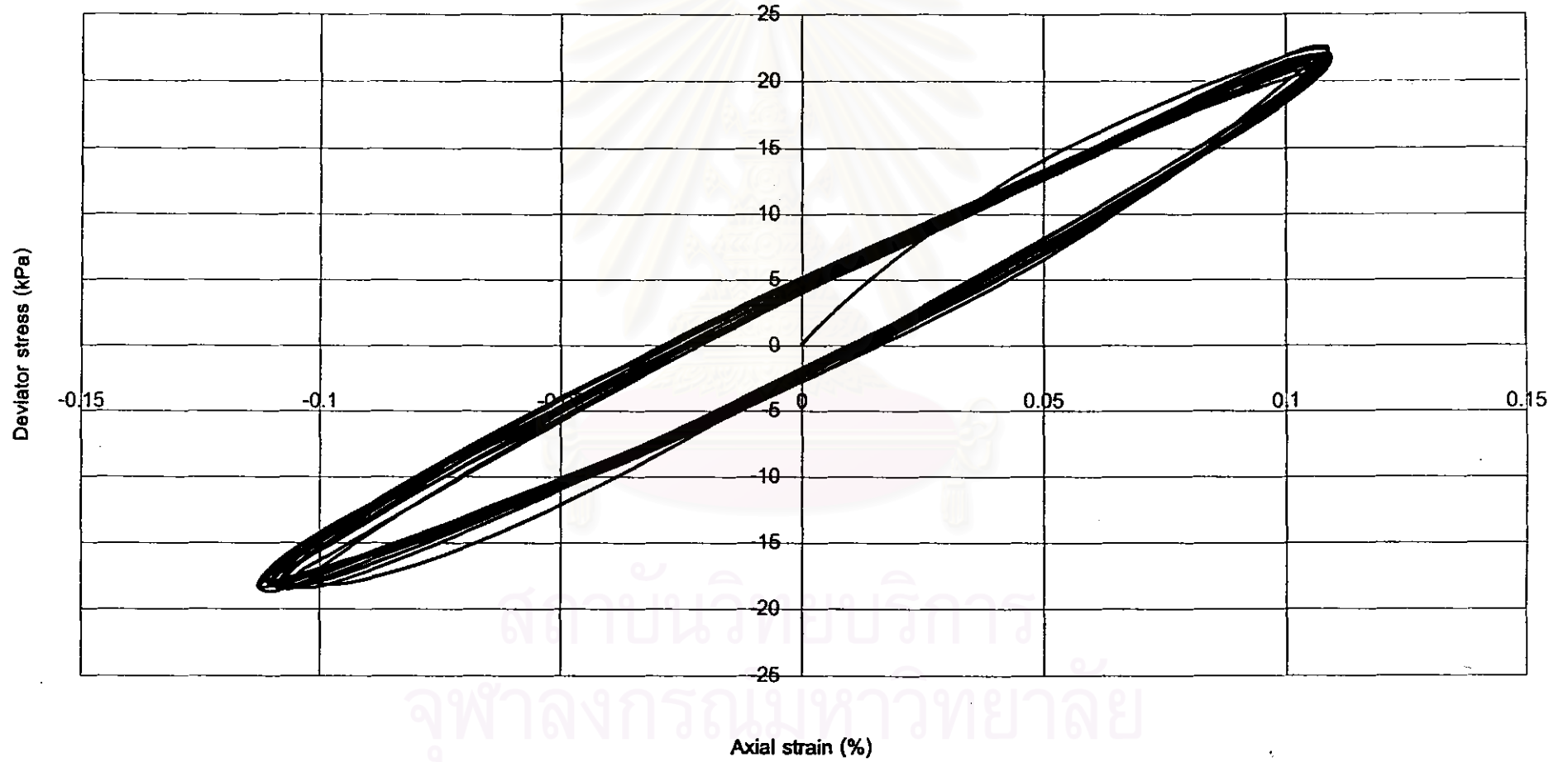

สถาบันวิทยบริการ
จุฬาลงกรณ์มหาวิทยาลัย

CU/45/40/0.10/1

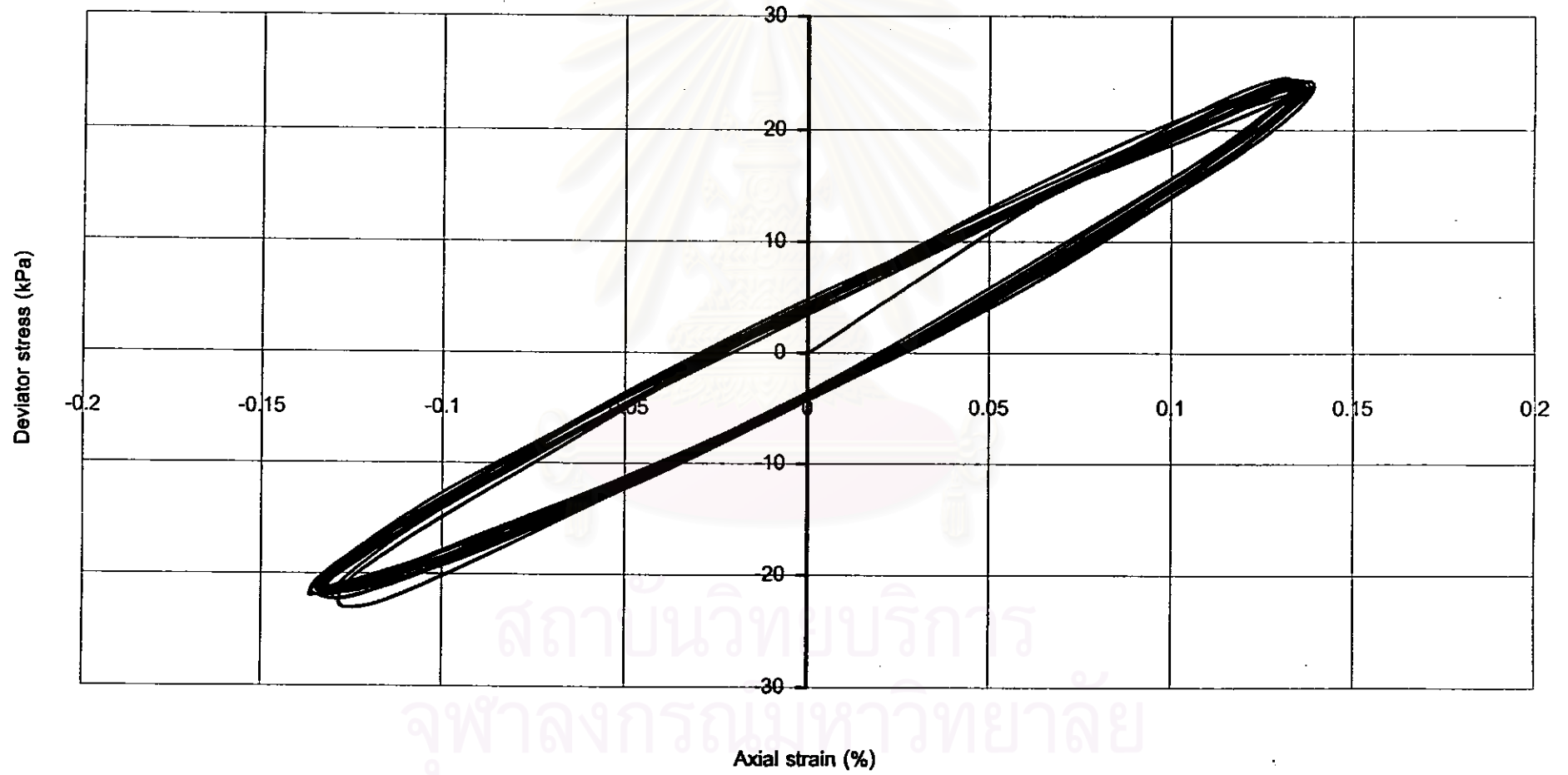

CU/20/40/0.10/2

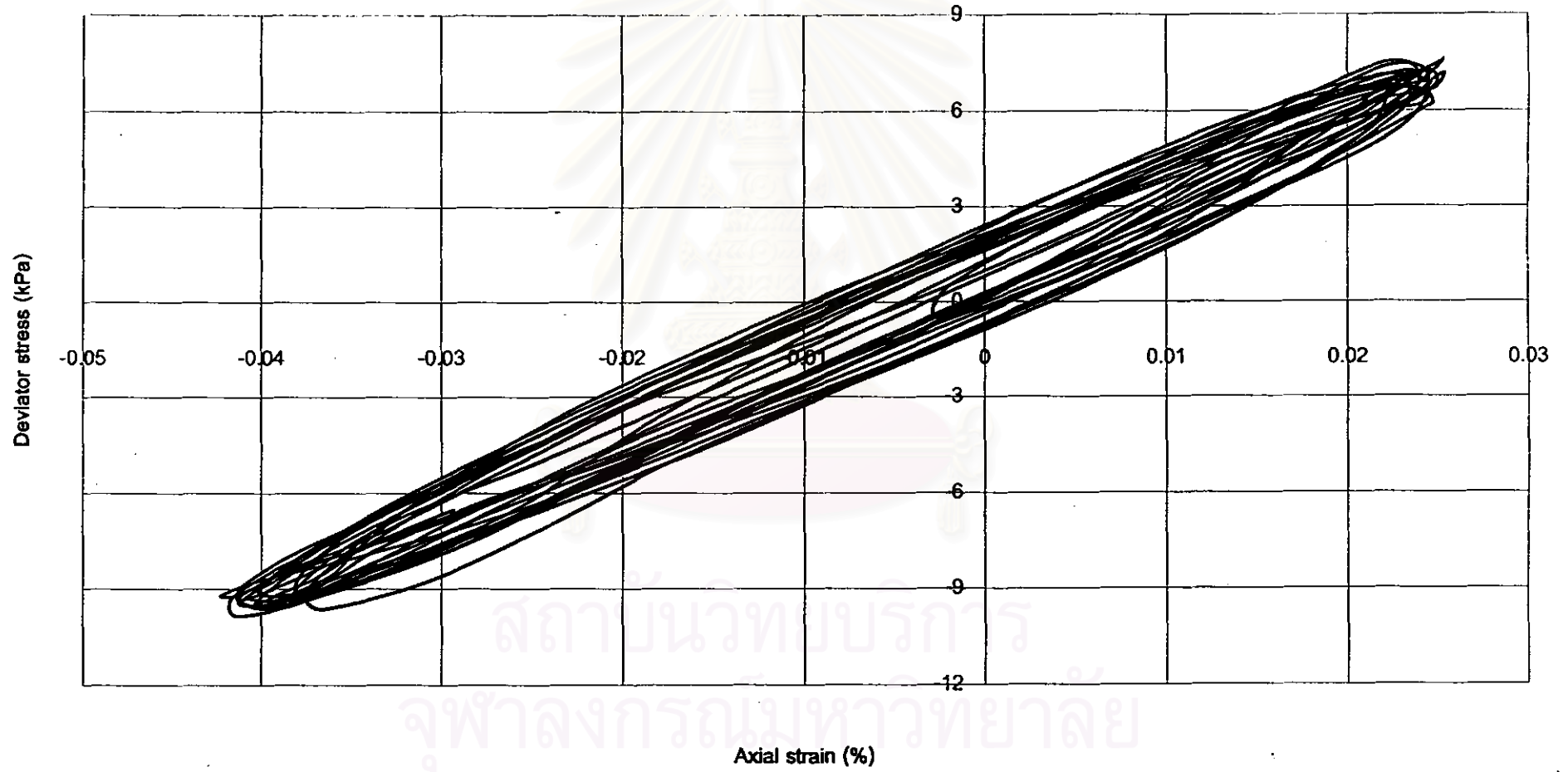

สถาบันวิทยบริการ
จุฬาลงกรณ์มหาวิทยาลัย

CU/30/40/40/0.10/2

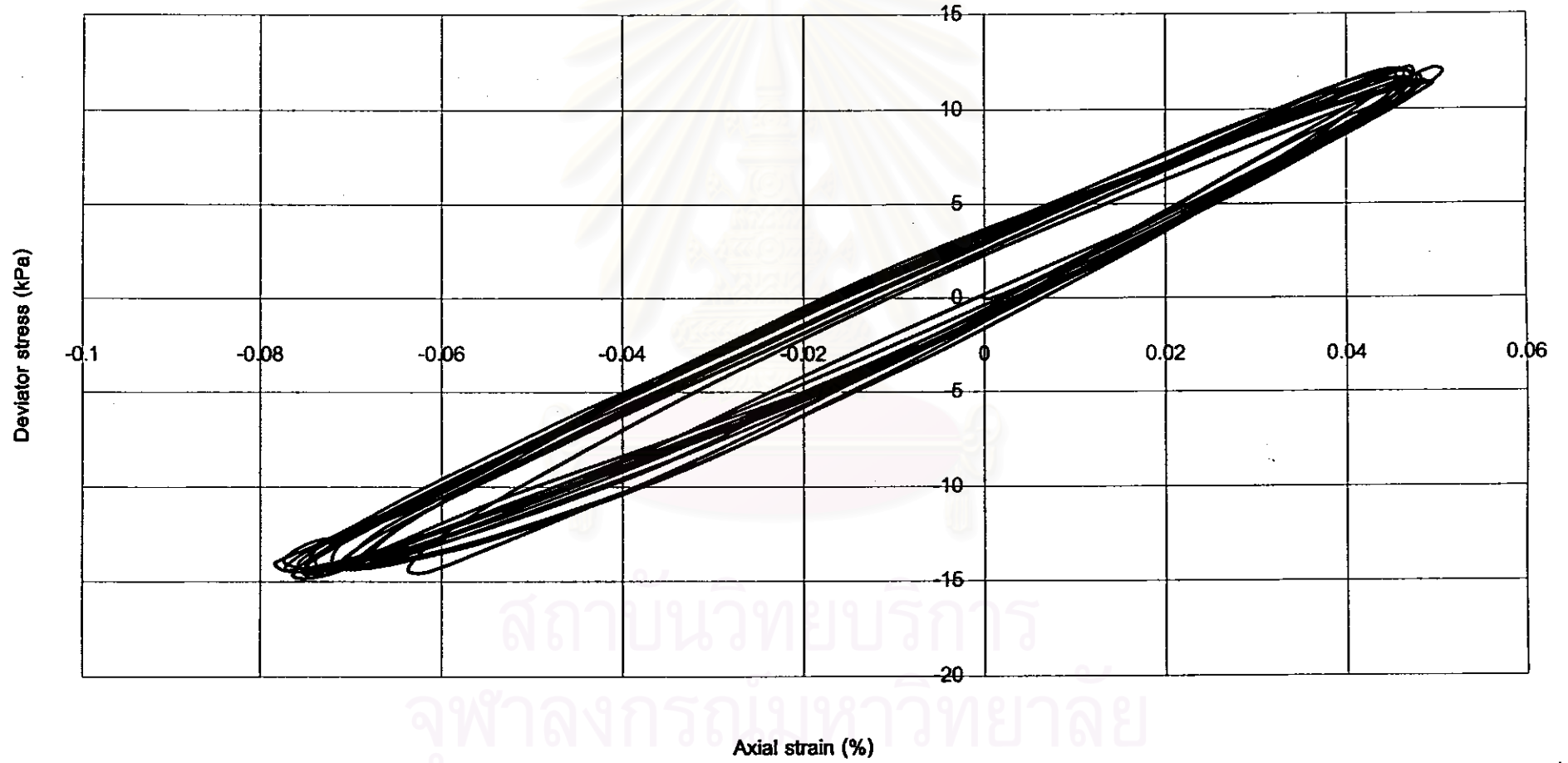

CU/45/40/0.10/2

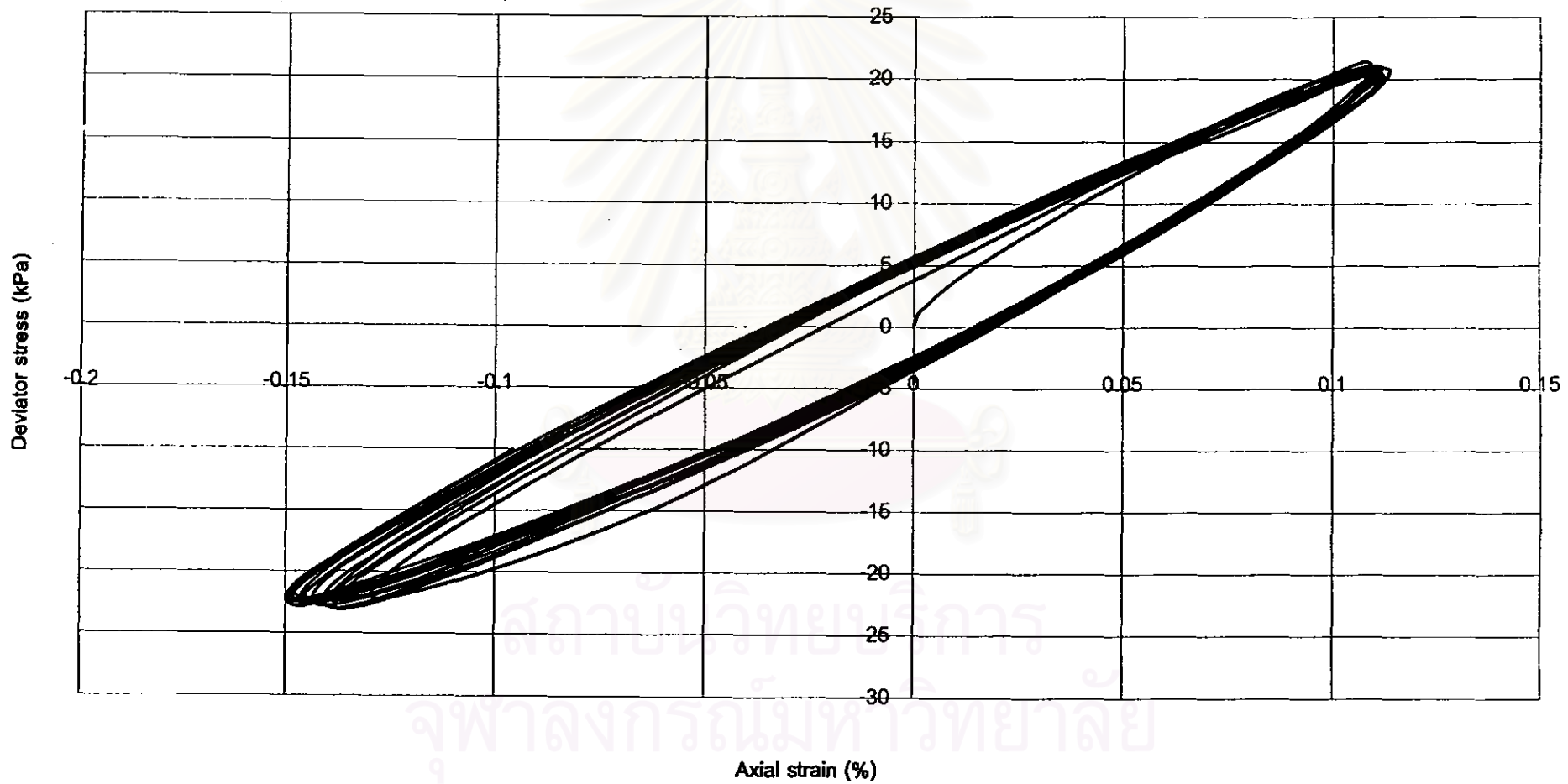

CU/60/40/0.10/2

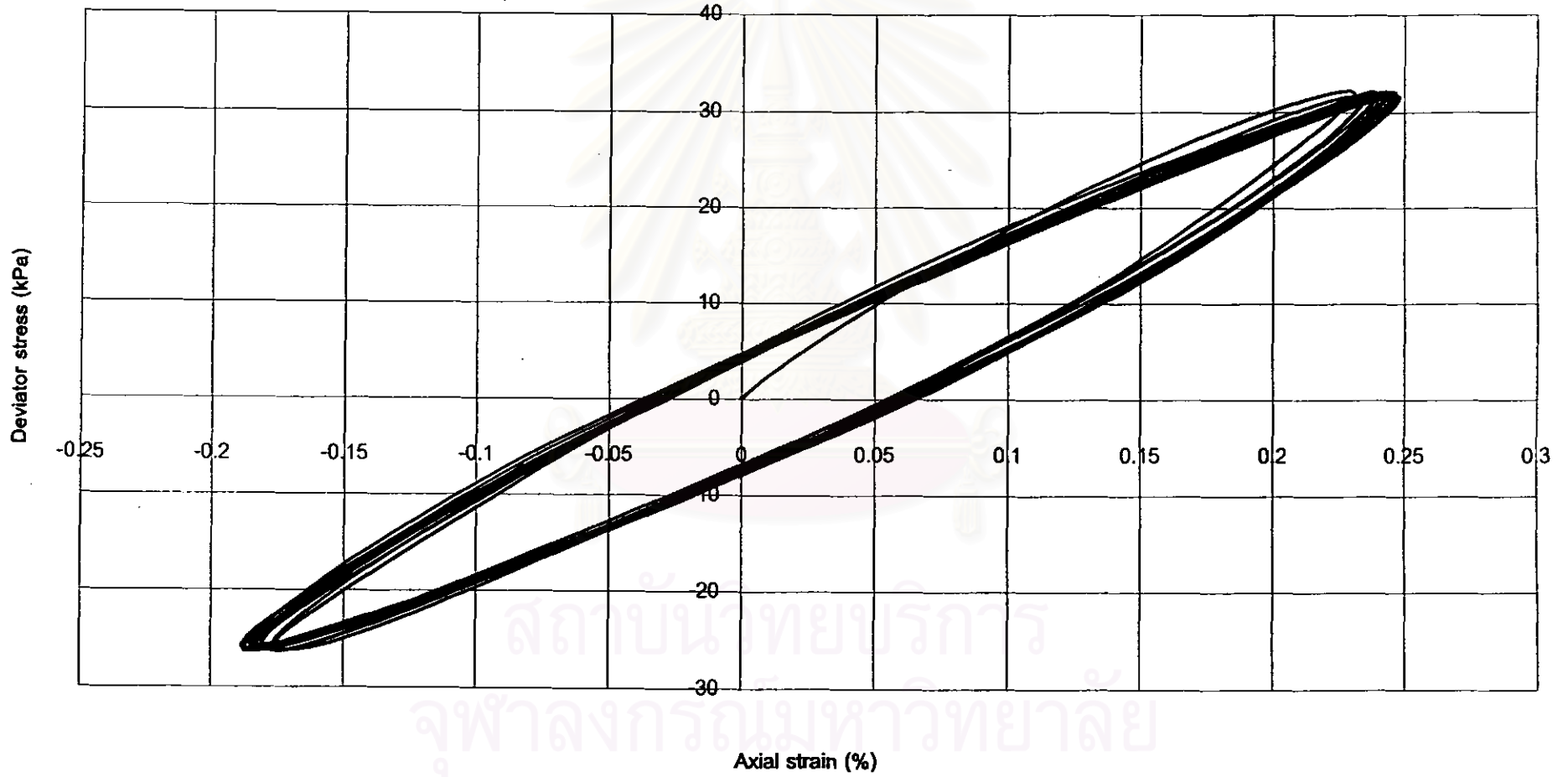

CU/100/40/0.10/3

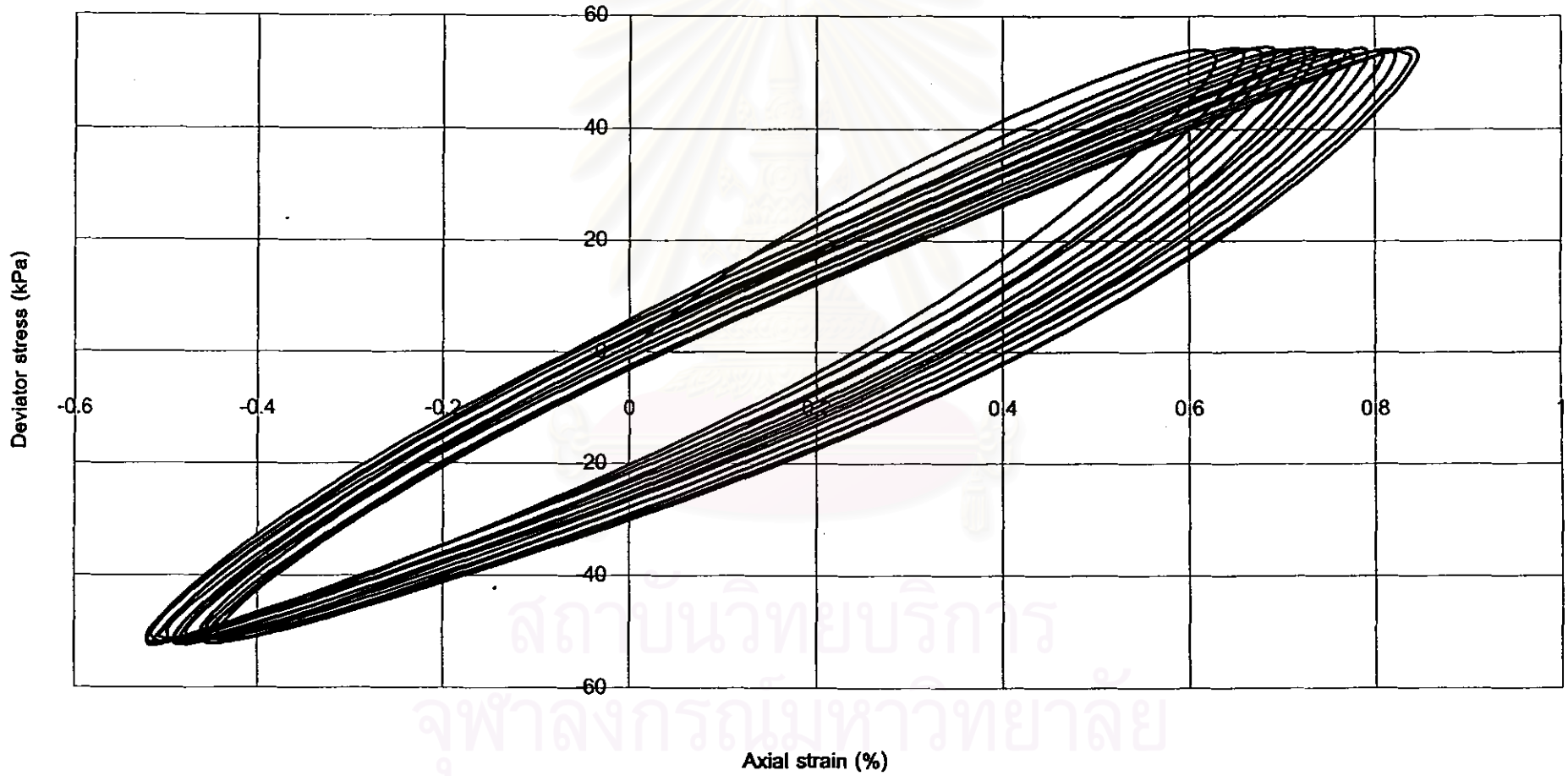

สถาบันวิทยบริการ
จุฬาลงกรณ์มหาวิทยาลัย

CU/130/40/0.10/3

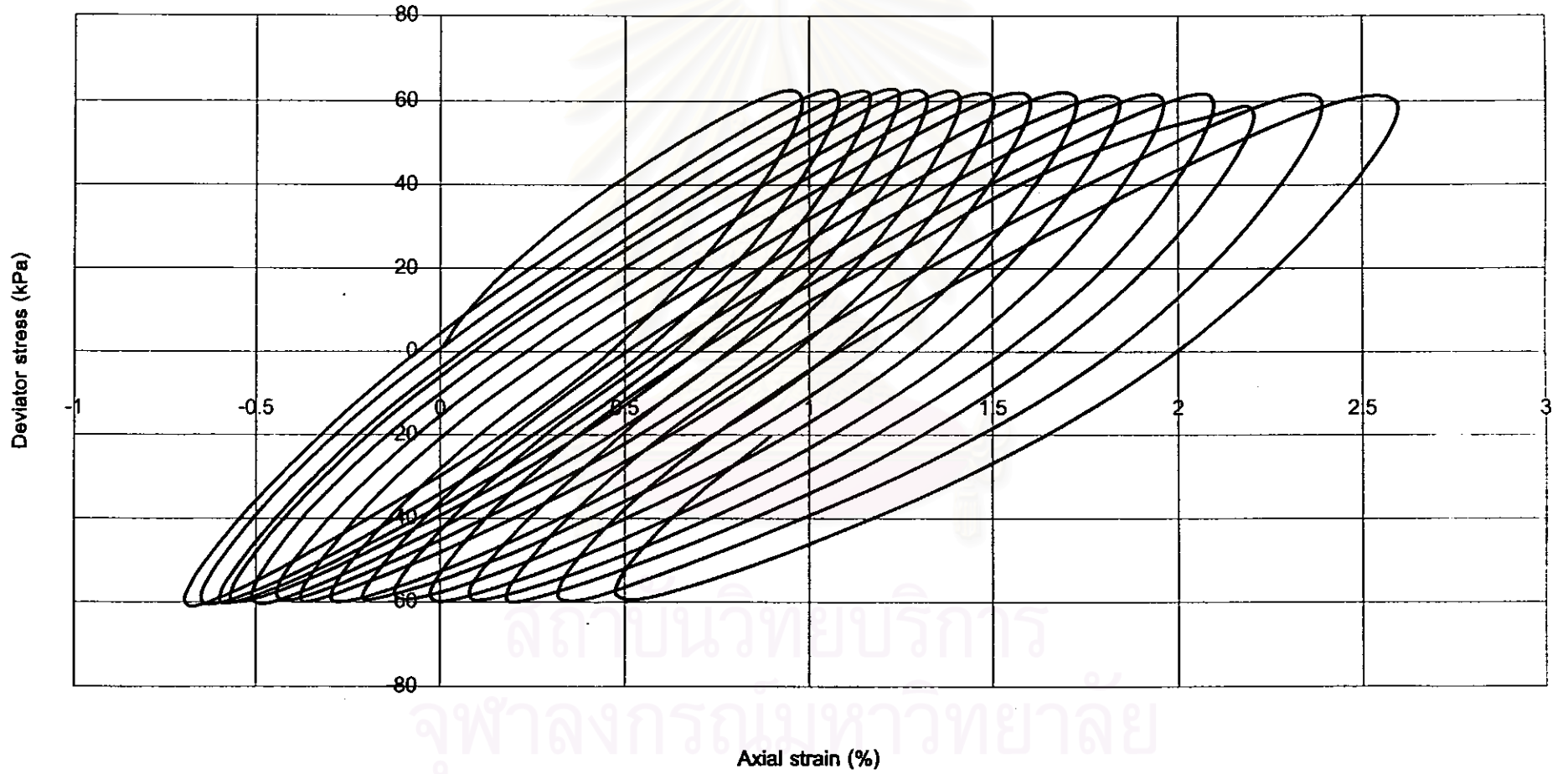

CU/20/40/1.0/1

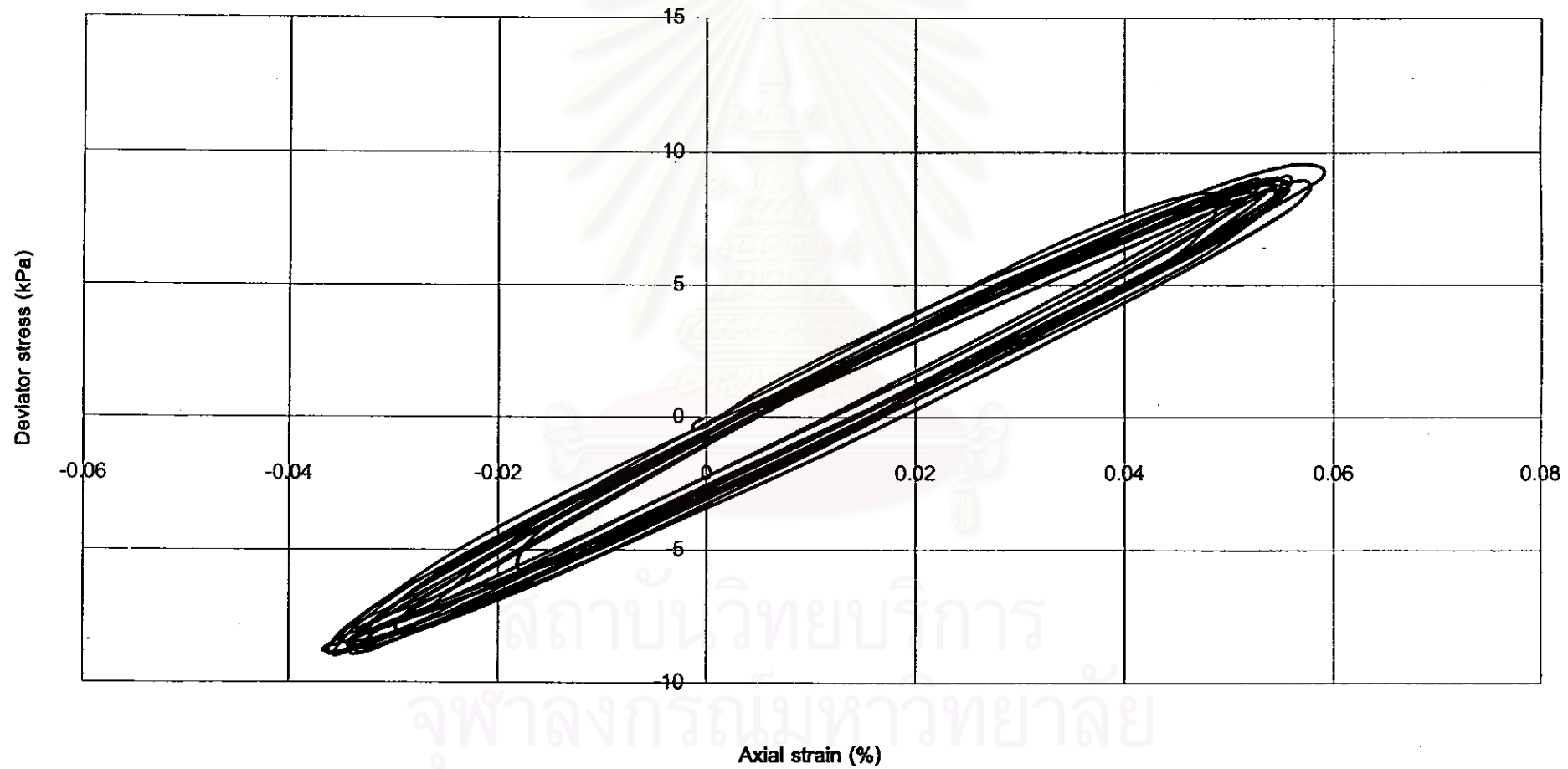

สถาบันวิทยบริการ
จุฬาลงกรณ์มหาวิทยาลัย

CU/55/40/1.0/1

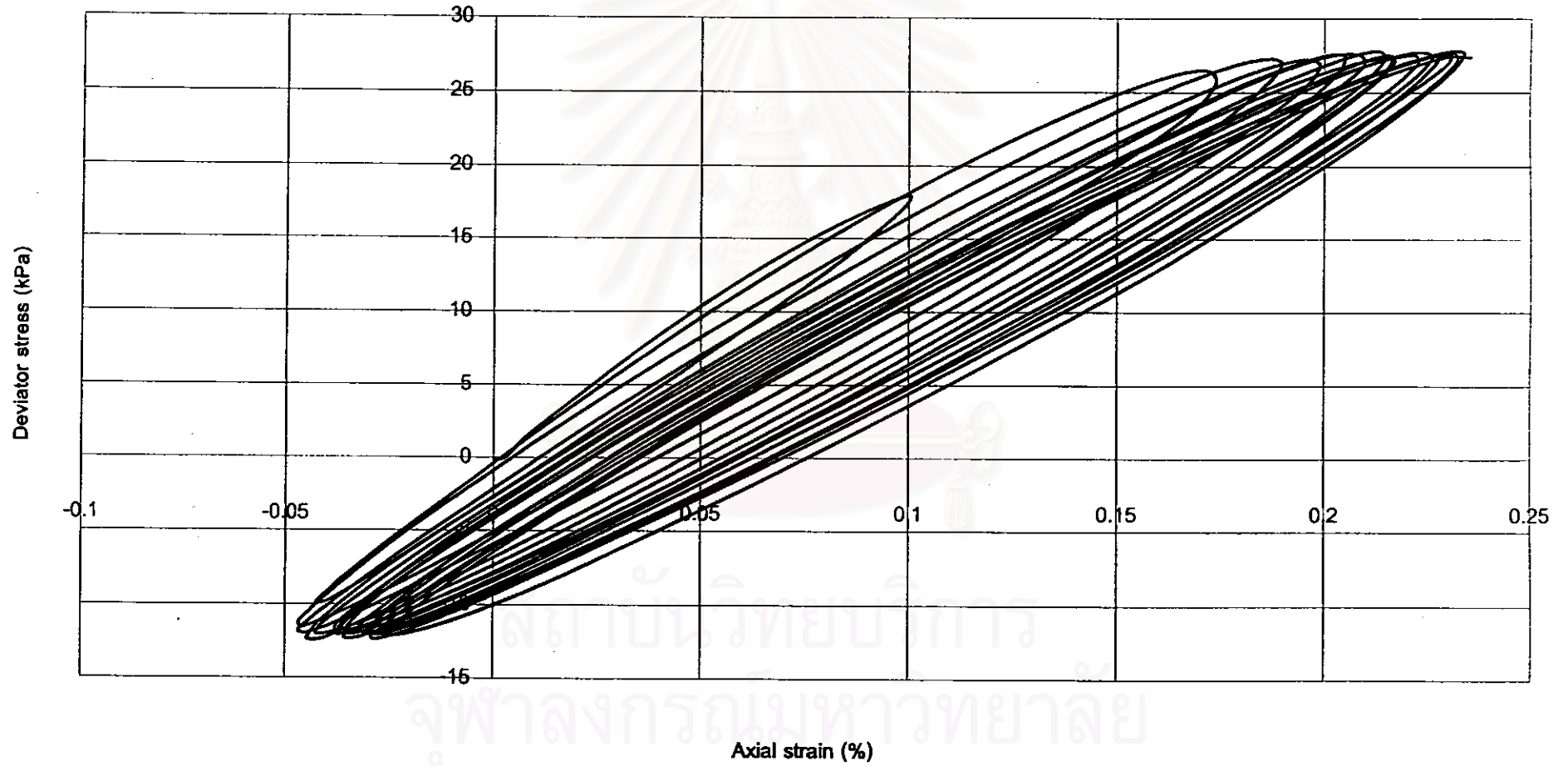

CU/20/40/1.0/2

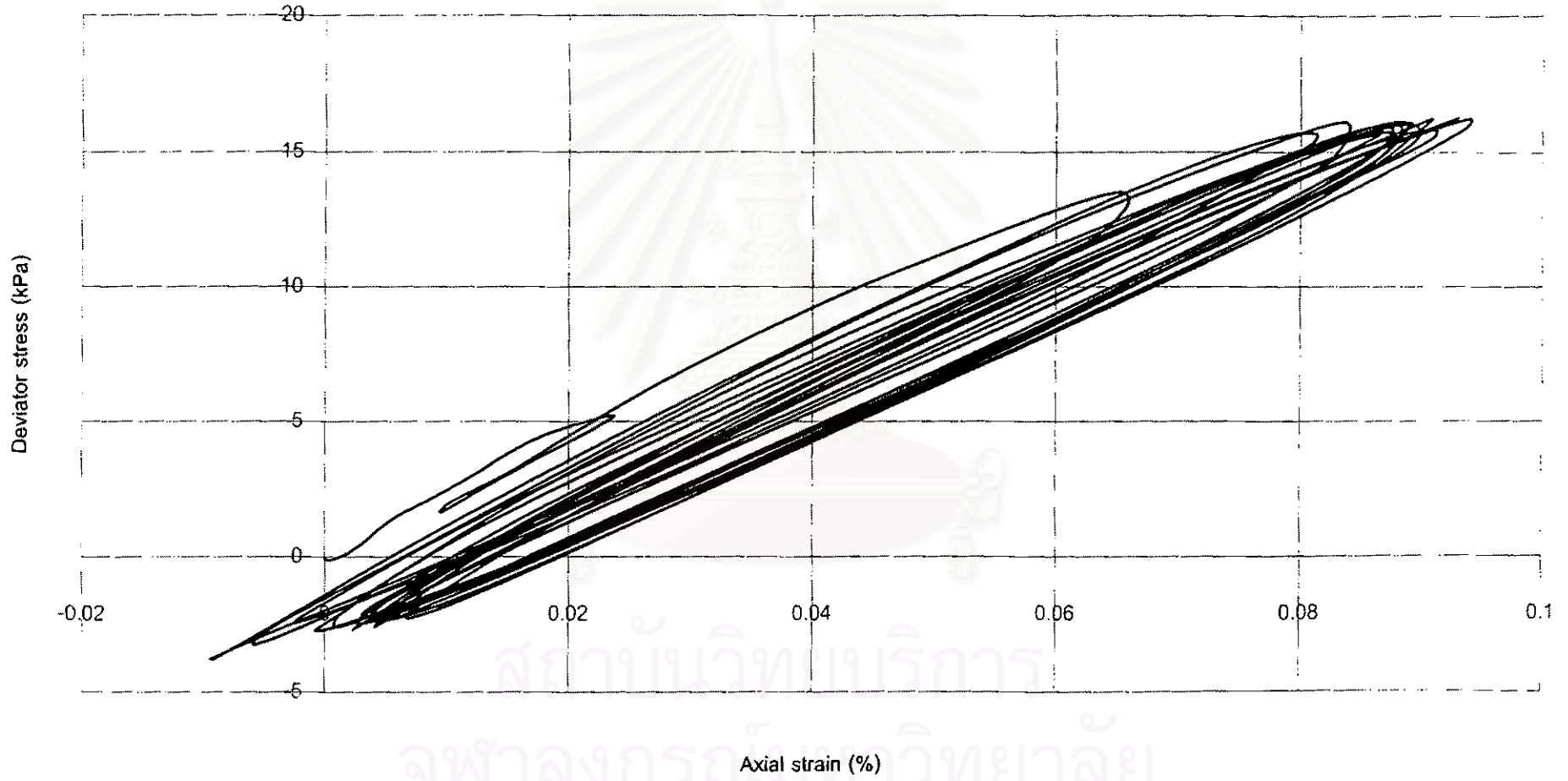

สถาบันวิศวกรรม
จุฬาลงกรณ์มหาวิทยาลัย

CU/30/40/1.0/2

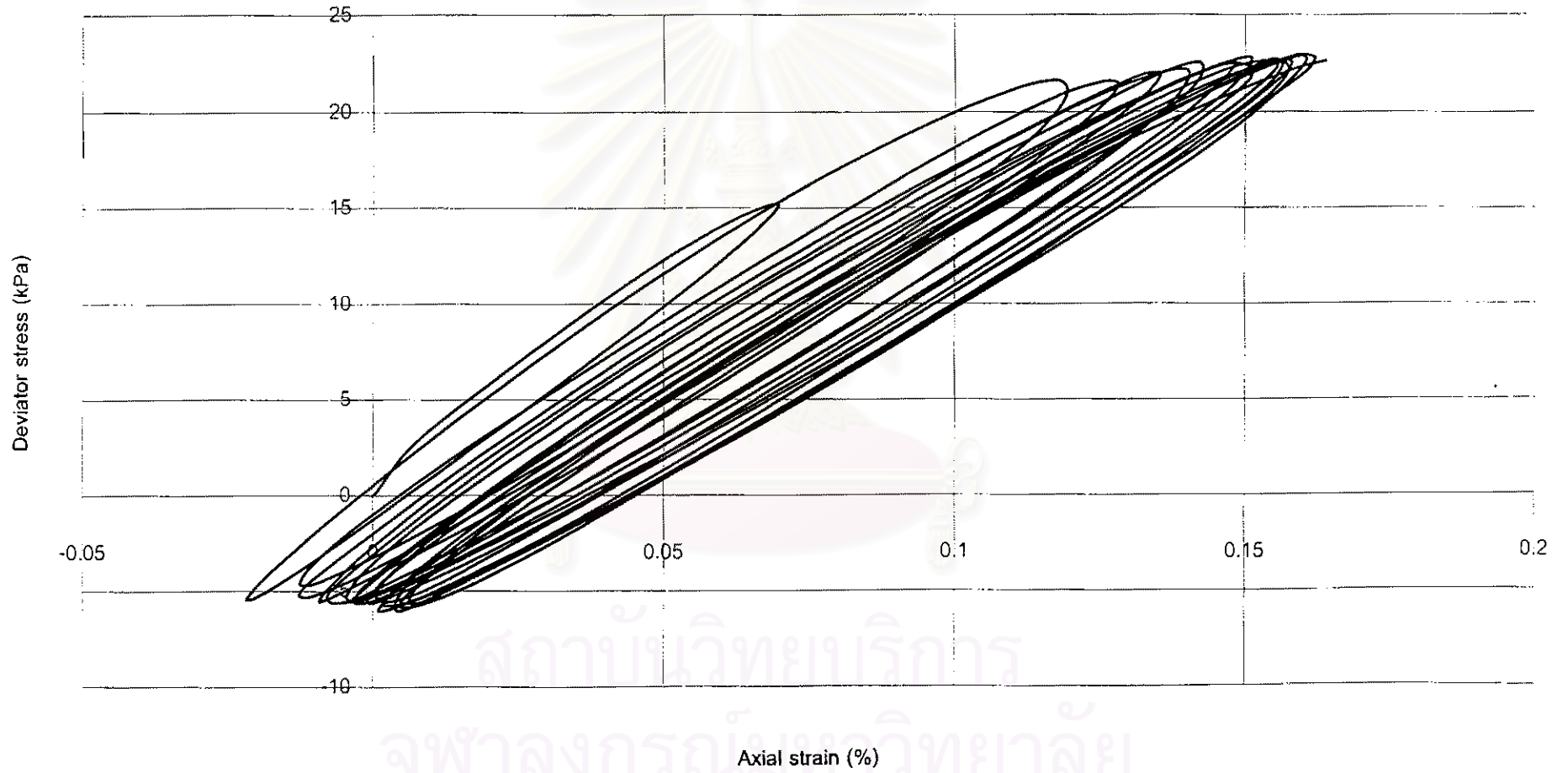

สถาบันวิทยบริการ
จุฬาลงกรณ์มหาวิทยาลัย

CU/60/40/1.0/2

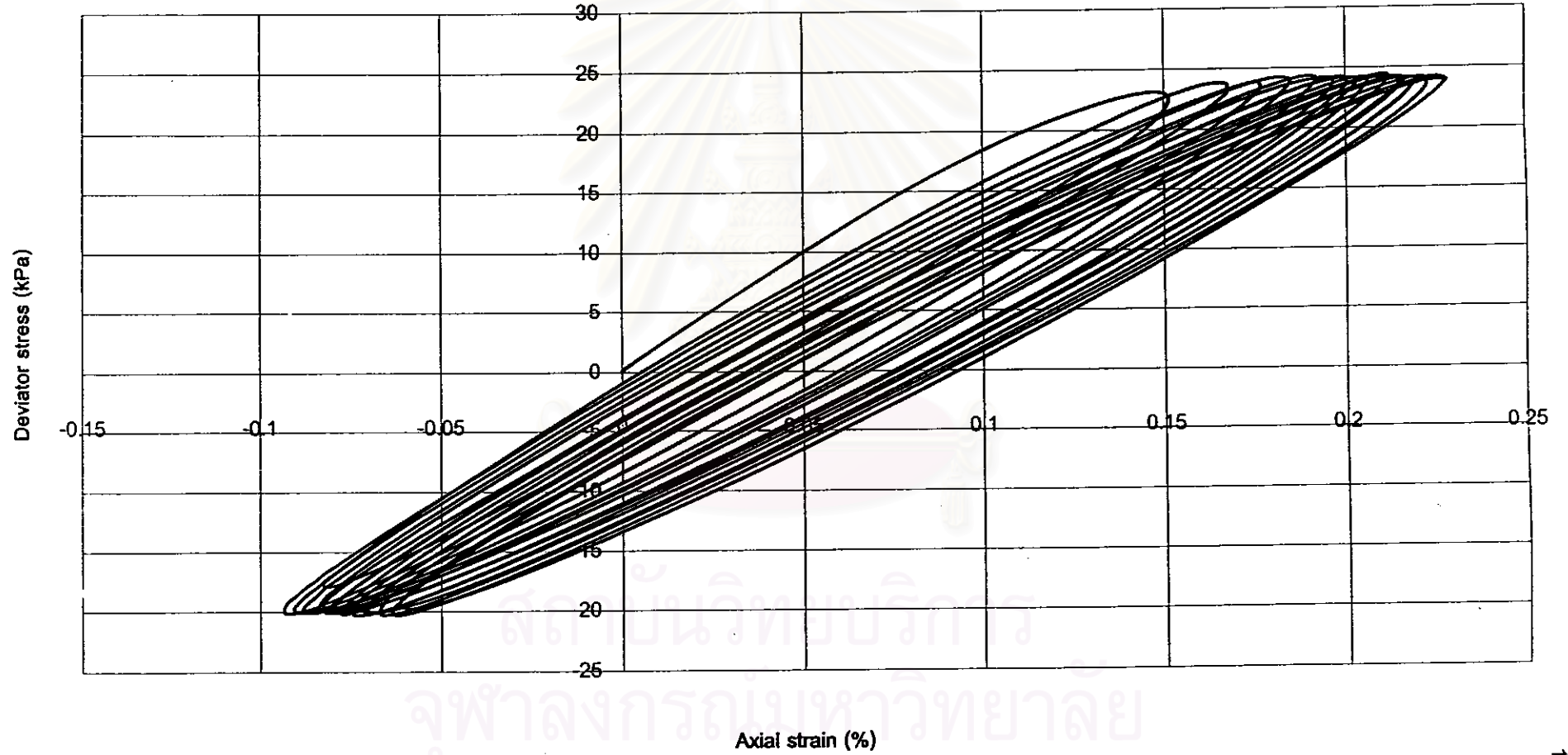

CU/20/70/0.10

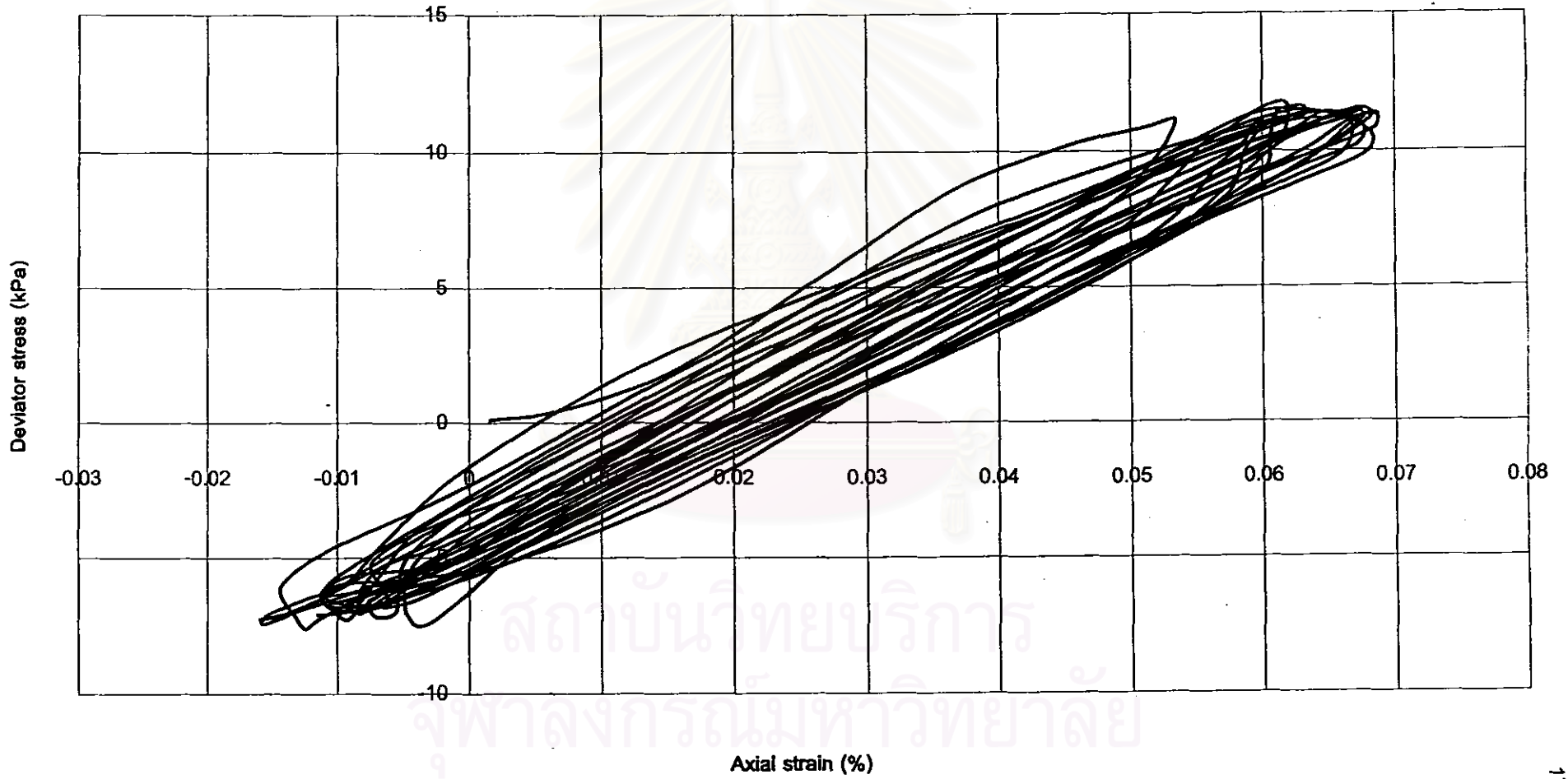

CU/40/70/0.10

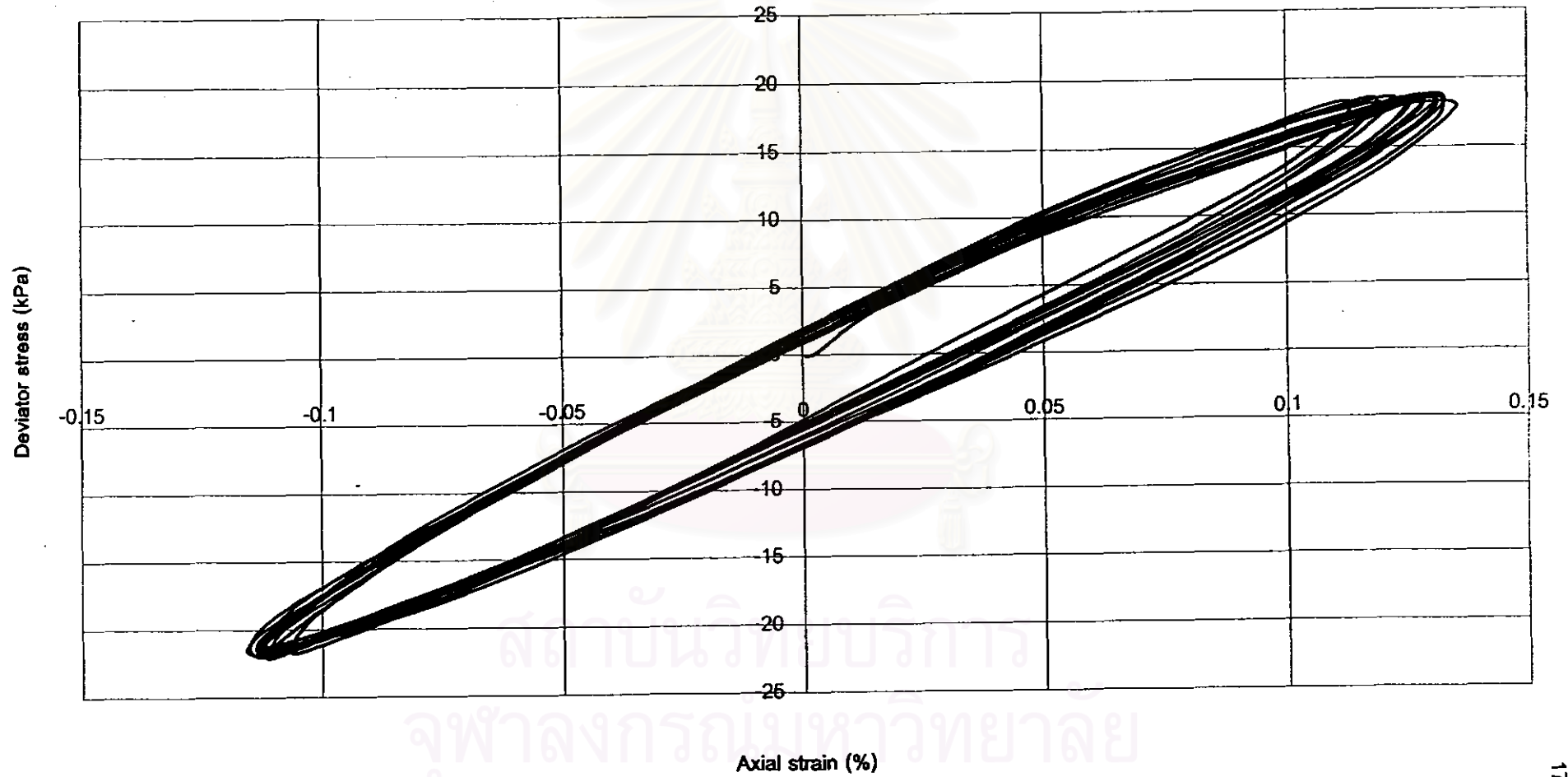

ศูนย์บริการ
จุฬาลงกรณ์มหาวิทยาลัย

CU70/70/0.10

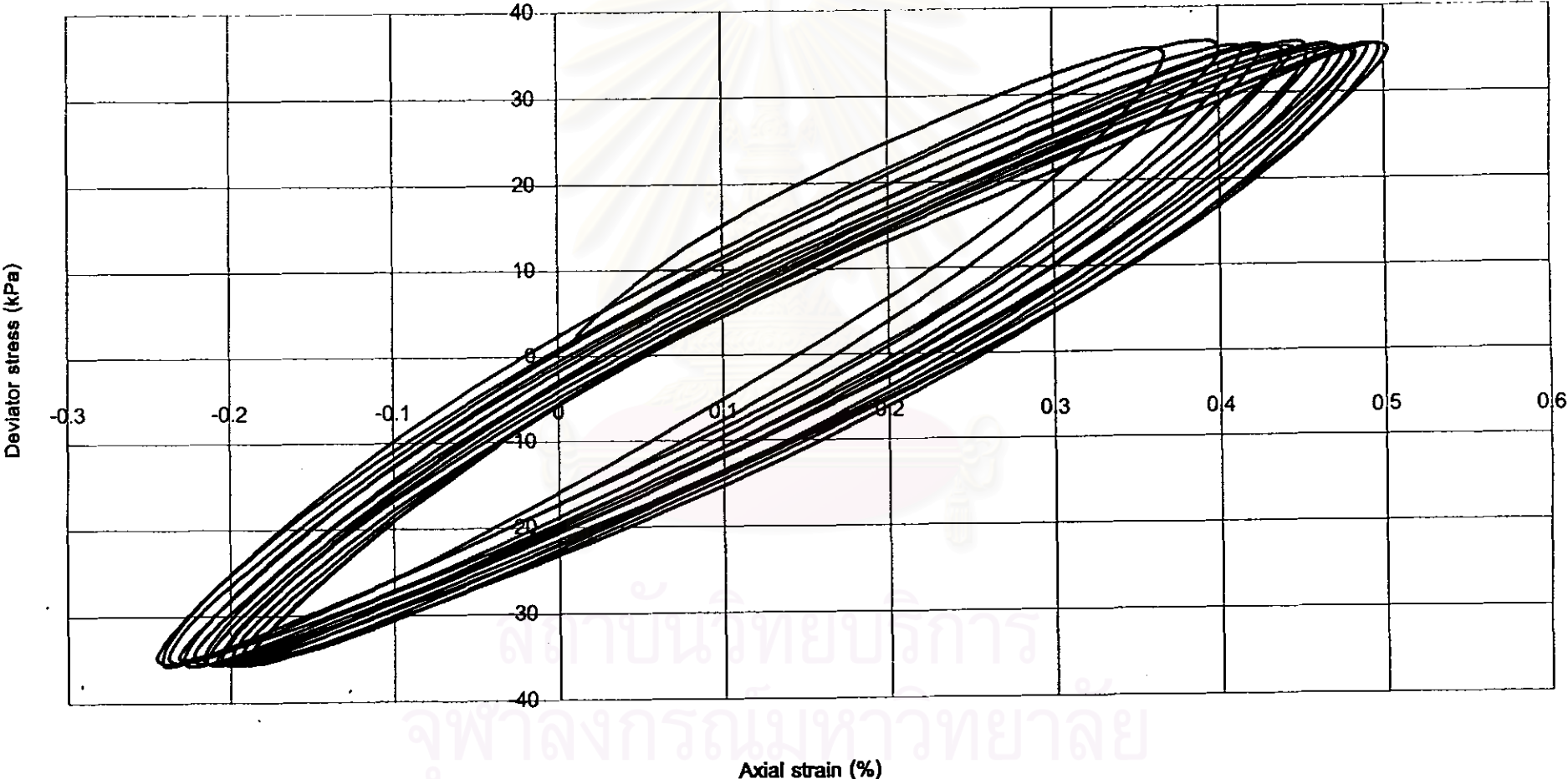

CU/90/70/0.10

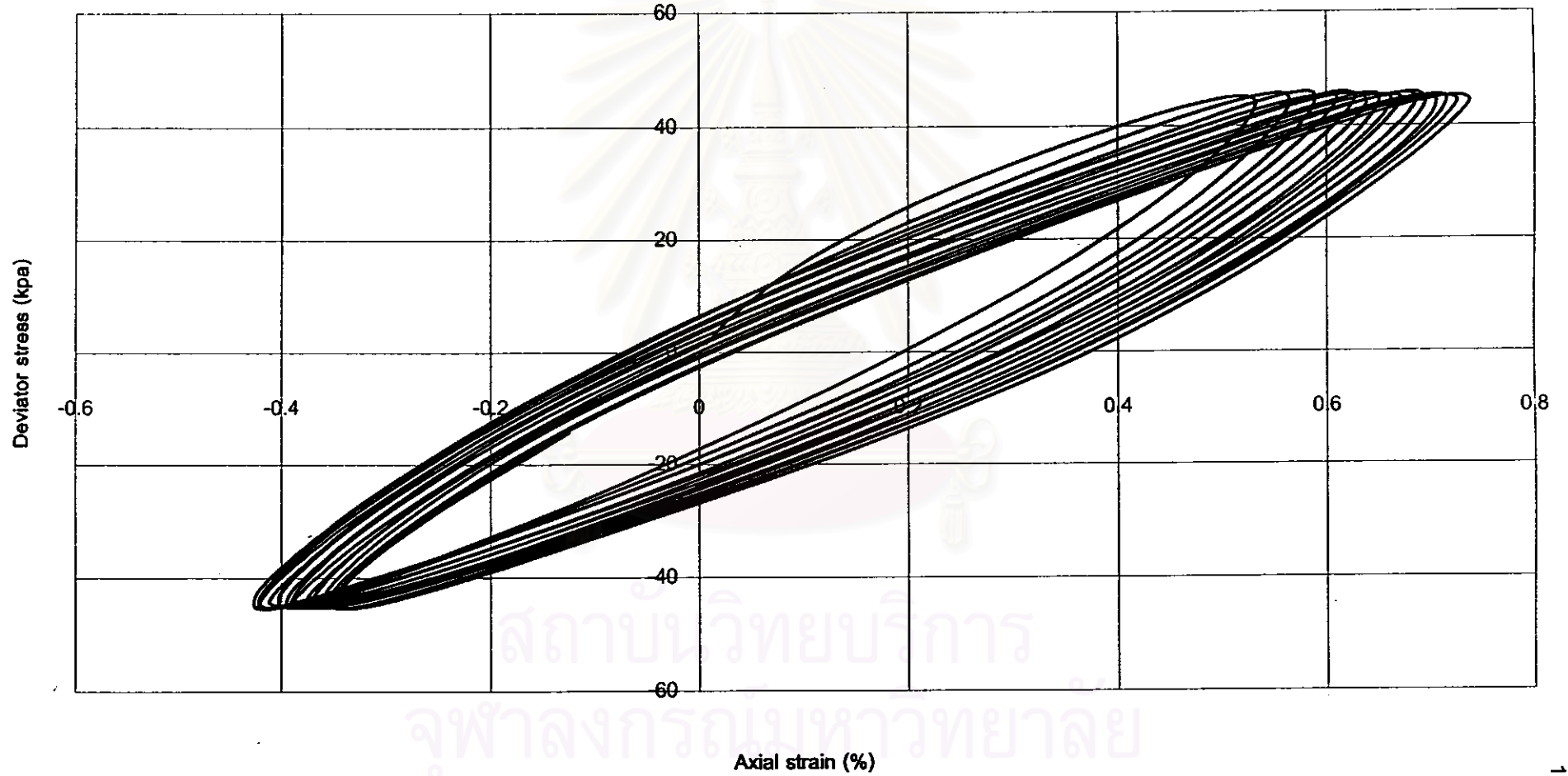

สถาบันวิทยบริการ
จุฬาลงกรณ์มหาวิทยาลัย

CU/120/70/0.10

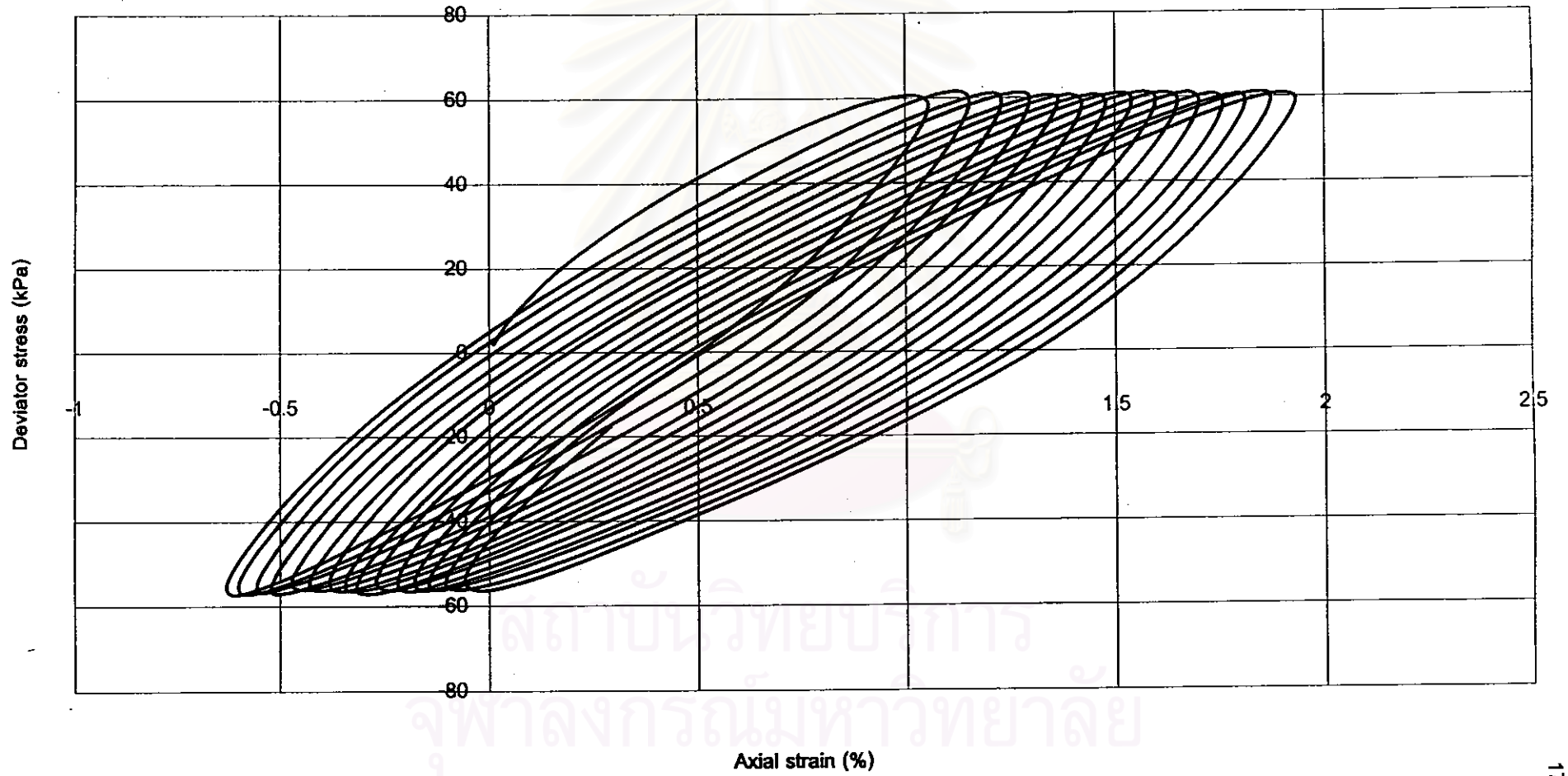

CU/140/70/0.10

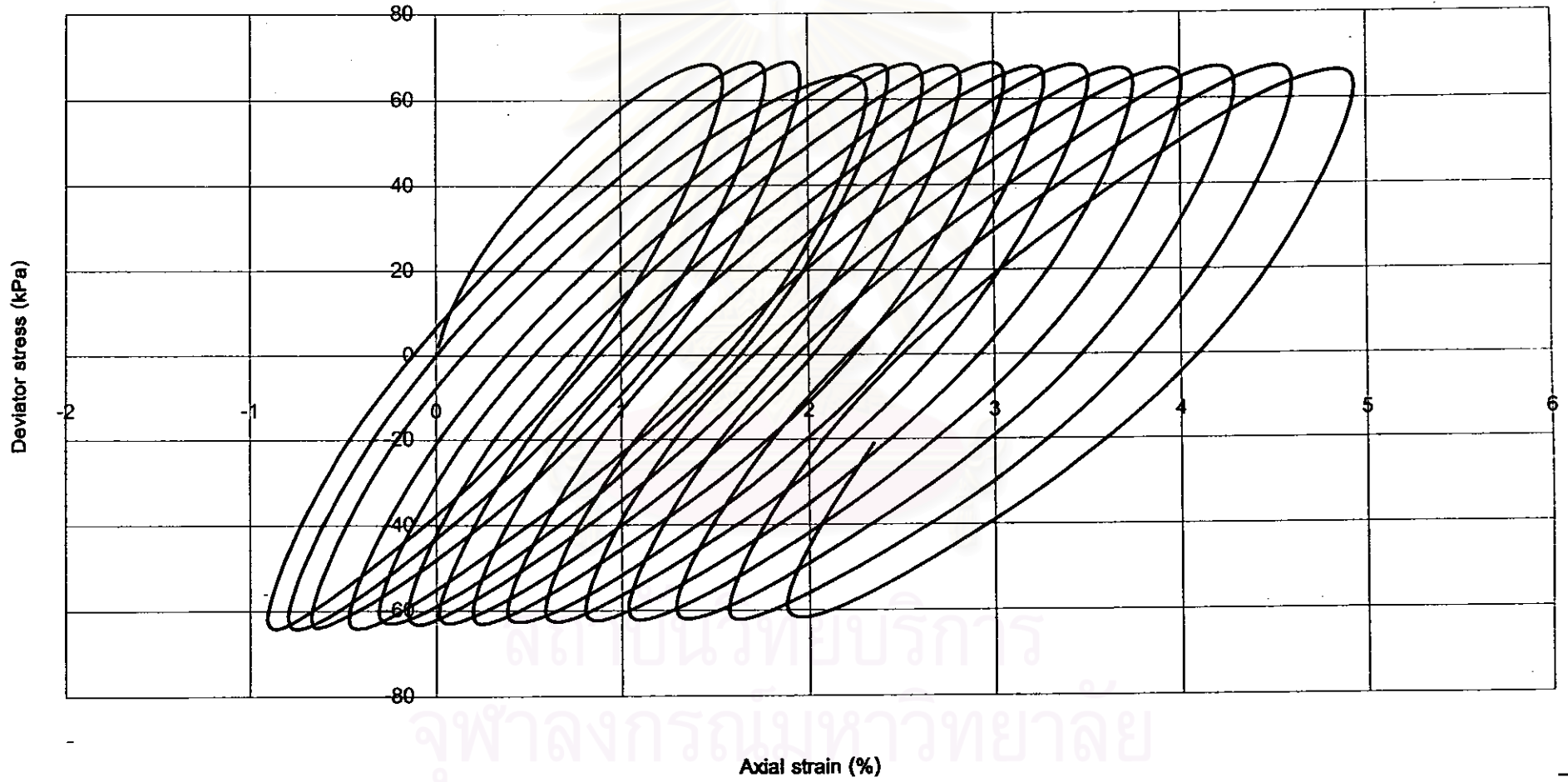



ภาคผนวก ข.

Standard Test Methods for the Determination of the Modulus and Damping Properties of
Soils Using the Cyclic Triaxial Apparatus

ASTM Designation: D 3999-91

สถาบันวิทยบริการ
จุฬาลงกรณ์มหาวิทยาลัย



Standard Test Methods for the Determination of the Modulus and Damping Properties of Soils Using the Cyclic Triaxial Apparatus¹

This standard is issued under the fixed designation D 3999; the number immediately following the designation indicates the year of original adoption or, in the case of revision, the year of last revision. A number in parentheses indicates the year of last reapproval. A superscript epsilon (ϵ) indicates an editorial change since the last revision or reapproval.

1. Scope

1.1 These test methods cover the determination of the modulus and damping properties of soils in either undisturbed or reconstituted states by either load or stroke controlled cyclic triaxial techniques.

1.2 The cyclic triaxial properties of soil are evaluated relative to a number of factors including: strain level, density, number of cycles, material type, saturation, and effective stress.

1.3 These test methods are applicable to both fine-grained and coarse-grained soils as defined by the unified soil classification system or by Classification D 2487. Test specimens may be undisturbed or reconstituted by compaction in the laboratory.

1.4 Two test methods are provided for using a cyclic loader to determine Young's modulus (E) and damping (D) properties. The first test method (A) permits the determination of E and D using a constant load apparatus. The second test method (B) permits the determination of E and D using a constant stroke apparatus. The test methods are as follows:

1.4.1 *Test Method A*—This test method requires the application of a constant cyclic load to the test specimen. It is used for determining the Young's modulus and damping under a constant load condition.

1.4.2 *Test Method B*—This test method requires the application of a constant cyclic deformation to the test specimen. It is used for determining the Young's modulus and damping under a constant stroke condition.

1.5 The development of relationships to aid in interpreting and evaluating test results are left to the engineer or officer requesting the test.

1.6 *Limitations*—There are certain limitations inherent in using cyclic triaxial tests to simulate the stress and strain conditions of a soil element in the field during an earthquake.

1.6.1 Nonuniform stress conditions within the test specimen are imposed by the specimen end platens.

1.6.2 A 90° change in the direction of the major principal stress occurs during the two halves of the loading cycle on isotropically confined specimens and at certain levels of cyclic stress application on anisotropically confined specimens.

1.6.3 The maximum cyclic axial stress that can be applied to a saturated specimen is controlled by the stress conditions

at the end of confining stress application and the pore-water pressures generated during testing. For an isotropically confined specimen tested in cyclic compression, the maximum cyclic axial stress that can be applied to the specimen is equal to the effective confining pressure. Since cohesionless soils are not capable of taking tension, cyclic axial stresses greater than this value tend to lift the top platen from the soil specimen. Also, as the pore-water pressure increases during tests performed on isotropically confined specimens, the effective confining pressure is reduced, contributing to the tendency of the specimen to neck during the extension portion of the load cycle, invalidating test results beyond that point.

1.6.4 While it is advised that the best possible undisturbed specimens be obtained for cyclic testing, it is sometimes necessary to reconstitute soil specimens. It has been shown that different methods of reconstituting specimens to the same density may result in significantly different cyclic behavior. Also, undisturbed specimens will almost always be stronger than reconstituted specimens of the same density.

1.6.5 The interaction between the specimen, membrane, and confining fluid has an influence on cyclic behavior. Membrane compliance effects cannot be readily accounted for in the test procedure or in interpretation of test results. Changes in pore-water pressure can cause changes in membrane penetration in specimens of cohesionless soils. These changes can significantly influence the test results.

1.6.6 Despite these limitations, with due consideration for the factors affecting test results, carefully conducted cyclic triaxial tests can provide data on the cyclic behavior of soils with a degree of accuracy adequate for meaningful evaluations of modulus and damping below a shearing strain level of 0.5 %.

1.7 The values stated in either SI or inch-pound units shall be regarded separately as standard. The values in each system may not be exact equivalents, therefore, each system must be used independently of the other, without combining values in any way.

1.8 *This standard does not purport to address all of the safety problems, if any, associated with its use. It is the responsibility of the user of this standard to establish appropriate safety and health practices and determine the applicability of regulatory limitations prior to use.*

2. Referenced Documents

- 2.1 *ASTM Standards:*
D 422 Method for Particle-Size Analysis of Soils²

¹ These test methods are under the jurisdiction of ASTM Committee D-18 on Soil and Rock and are the direct responsibility of Subcommittee D18.09 on Dynamic Properties of Soils.

Current edition approved August 15, 1991. Published October 1991.

² *Annual Book of ASTM Standards*, Vol 04.08.

- D 653 Terminology Relating to Soil, Rock, and Contained Fluids²
- D 854 Test Method for Specific Gravity of Soils²
- D 1587 Method for Thin-Walled Tube Sampling of Soils²
- D 2216 Method for Laboratory Determination of Water (Moisture) Content of Soil, Rock, and Soil-Aggregate Mixtures²
- D 2435 Test Method for One-Dimensional Consolidation Properties of Soils²
- D 2487 Classification of Soils for Engineering Purposes²
- D 2488 Practice for Description and Identification of Soils (Visual-Manual Procedure)²
- D 4220 Practices for Preserving and Transporting Soil Samples²
- D 4318 Test Methods for Liquid Limit, Plastic Limit, and Plasticity Index of Soils²
- D 4767 Test Method for Consolidated-Undrained Triaxial Compression Test on Cohesive Soils²
- 2.2 *USBR Standard:*
- USBR 5210 Practice for Preparing Compacted Soil Specimens for Laboratory Use³

3. Terminology

3.1 Definitions:

3.1.1 The definitions of terms used in these test methods shall be in accordance with Terminology D 653.

3.2 Descriptions of Terms Specific to This Standard:

3.2.1 *back pressure*—a pressure applied to the specimen pore-water to cause air in the pore space to pass into solution in the pore-water, that is, to saturate the specimen.

3.2.2 *cycle duration*—the time interval between successive applications of a deviator stress.

3.2.3 *deviator stress* [FL^{-2}]*—the difference between the major and minor principal stresses in a triaxial test.*

3.2.4 *effective confining stress*—the confining pressure (the difference between the cell pressure and the pore-water pressure) prior to shearing the specimen.

3.2.5 *effective force, (F)*—the force transmitted through a soil or rock mass by intergranular pressures.

3.2.6 *hysteresis loop*—a trace of load versus deformation resulting from the application of one complete cycle of either a cyclic load or deformation. The area within the resulting loop is due to energy dissipated by the specimen and apparatus, see Fig. 1.

3.2.7 *load duration*—the time interval the specimen is subjected to a cyclic deviator stress.

3.2.8 *principal stress*—the stress normal to one of three mutually perpendicular planes on which the shear stresses at a point in a body are zero.

3.2.9 *Young's modulus (modulus of elasticity)* [FL^{-2}]*—the ratio of stress to strain for a material under given loading conditions; numerically equal to the slope of the tangent or the secant of a stress-strain curve (same as Terminology D 653).*

4. Summary of Test Method

4.1 The cyclic triaxial test consists of imposing either a cyclic axial deviator stress of fixed magnitude (load control)

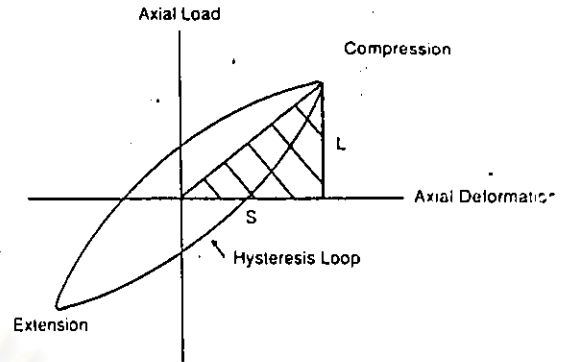

FIG. 1 Schematic of Typical Hysteresis Loop Generated by Cyclic Triaxial Apparatus

or cyclic axial deformation (stroke control) on a cylindrical soil specimen enclosed in a triaxial pressure cell. The resulting axial strain and axial stress are measured and used to calculate either stress-dependent or stroke-dependent modulus and damping.

5. Significance and Use

5.1 The cyclic triaxial modulus and damping test provides parameters that may be considered for use in dynamic, linear and non-linear analytical methods. These test methods are used for the performance evaluation of both natural and engineered structures under dynamic of cyclic loads such as caused by earthquakes, ocean wave, or blast.

5.2 One of the primary purposes of these test methods is to obtain data that are used to calculate Young's modulus.

6. Apparatus

6.1 *General*—In many ways, triaxial equipment suitable for cyclic triaxial modulus and damping tests is similar to equipment used for the consolidated-undrained triaxial compression test (see Test Method D 4767). However, there are special features described in the following sections that are required to perform acceptable cyclic triaxial tests. A schematic representation of the various components comprising a typical triaxial modulus and damping test setup is shown in Fig. 2.

6.2 *Triaxial Pressure Cell*—The primary considerations in selecting the cell are tolerances for the piston, top platen, and low friction piston seal, Fig. 3.

6.2.1 Two linear ball bushings or similar bearings should be used to guide the load rod to minimize friction and to maintain alignment.

6.2.2 The load rod diameter should be large enough to minimize lateral bending. A minimum load rod diameter of $\frac{1}{8}$ the specimen diameter has been used successfully in many laboratories.

6.2.3 The load rod seal is a critical element in triaxial cell design for cyclic soils testing if an external load cell connected to the loading rod is employed. The seal must exert negligible friction on the load rod. The maximum acceptable piston friction tolerable without applying load corrections is

³ Available from U.S. Department of the Interior, Bureau of Reclamation.

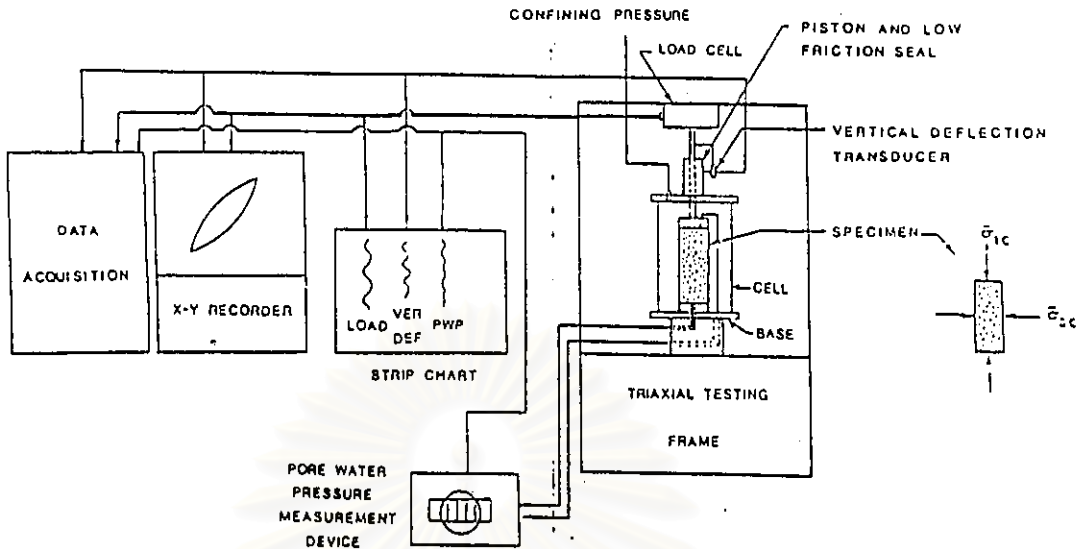

FIG. 2 Schematic Representation of Load or Stroke-Controlled Cyclic Triaxial Test Setup

commonly considered to be $\pm 2\%$ of the maximum single amplitude cyclic load applied in the test, refer to Fig. 4. The use of a seal described in 9.1 and described by Ladd and Dutko⁴, and Chan⁵ will meet these requirements.

6.2.4 Top and bottom platen alignment is critical to avoid increasing a nonuniform state of stress in the specimen. Internal tie-rod triaxial cells have worked well at a number of laboratories. These cells allow the placement of the cell wall after the specimen is in place between the loading platens. Acceptable limits on platen eccentricity and parallelism are shown in Fig. 5.

6.2.5 Since axial loading in cyclic triaxial tests is in extension as well as in compression, the load rod shall be rigidly connected to the top platen by a method such as one of those shown in Fig. 6.

6.2.6 There shall be provision for specimen drainage at both the top and bottom platens.

6.3 Cyclic Loading Equipment:

6.3.1 Cyclic loading equipment used for load controlled cyclic triaxial tests must be capable of applying a uniform sinusoidal load at a frequency within the range of 0.1 to 2 Hz. The loading device must be able to maintain uniform cyclic loadings to at least 0.5% double amplitude stress, refer to Fig. 4. Unsymmetrical compression-extension load peaks, nonuniformity of pulse duration, "ringing", or load fall-off at large strains must not exceed tolerances illustrated in Fig. 7. The equipment must also be able to apply the cyclic load about an initial static load on the loading rod.

6.3.2 Cyclic loading equipment used for deformation-

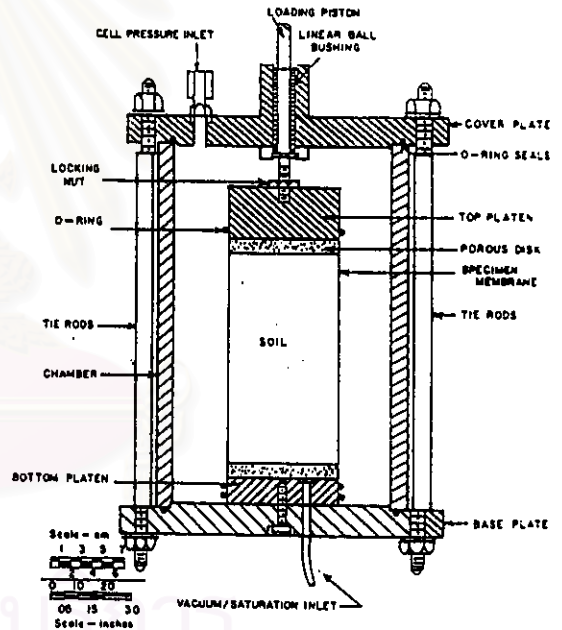
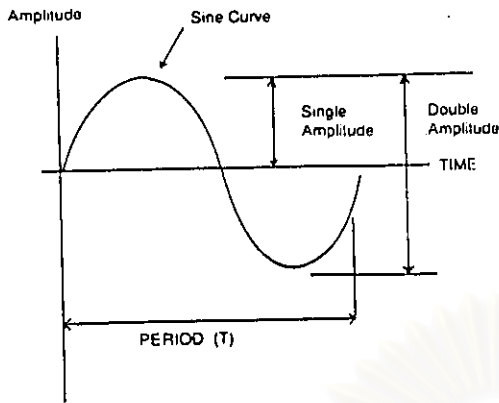

FIG. 3 Typical Cyclic Triaxial Pressure Cell

⁴Ladd, R. S., and Dutko, P., "Small Strain Measurements Using Triaxial Apparatus," *Advances In The Art of Testing Soils Under Cyclic Conditions*, V. Khosla, ed., American Society of Civil Engineers, 1985.
⁵Chan, C. K., "Low Friction Seal System" *Journal of the Geotechnical Engineering Division*, American Society of Civil Engineers, Vol. 101, GT-9, 1975, pp. 991-995.

controlled cyclic triaxial tests must be capable of applying a uniform sinusoidal deformation at a frequency range of 0.1 to 2 Hz. The equipment must also be able to apply the cyclic deformation about either an initial datum point or follow the specimen as it deforms. The type of apparatus typically



NOTE—Frequency = $\frac{1}{\text{PERIOD}} = \frac{1}{T}$

FIG. 4 Definitions Related to Cyclic Loading

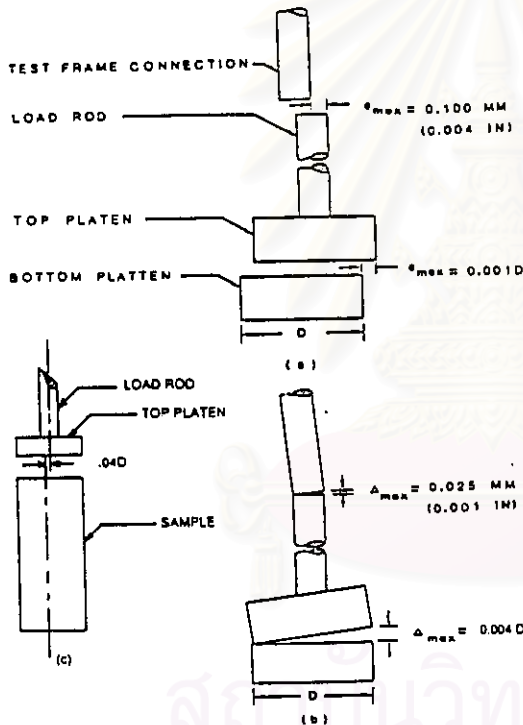

FIG. 5 Limits on Acceptable Platen and Load Rod Alignment: (a) eccentricity, (b) parallelism, (c) eccentricity between Top Platen and Sample

employed can range from a simple cam to a closed loop electro-hydraulic system.

6.4 Recording Equipment:

6.4.1 Load, displacement, and pore water pressure trans-

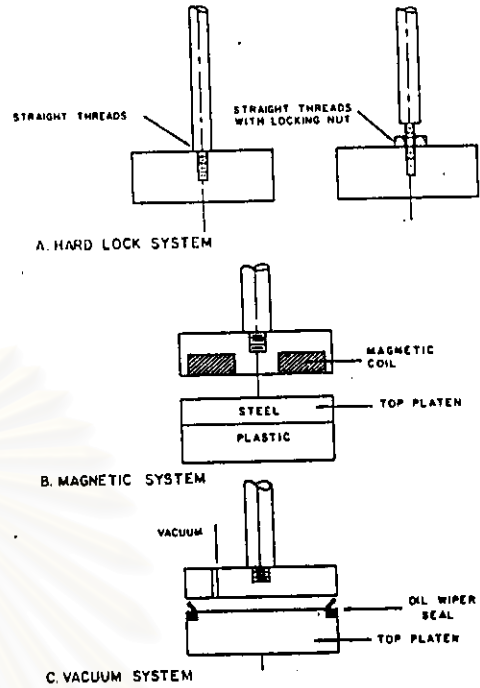

FIG. 6 Top Platen Connections

ducers are required to monitor specimen behavior during cyclic loading; provisions for monitoring the chamber pressure during cyclic loading are optional.

6.4.2 Load Measurement—Generally, the load cell capacity should be no greater than five times the total maximum load applied to the test specimen to ensure that the necessary measurement accuracy is achieved. The minimum performance characteristics of the load cell are presented in Table 1.

6.4.3 Axial Deformation Measurement—Displacement measuring devices such as linear variable differential transformer (LVDT), Potentiometer-type deformation transducers, and eddy current sensors may be used if they meet the required performance criteria (see Table 1). Accurate deformation measurements require that the transducer be properly mounted to avoid excessive mechanical system compression between the load frame, the triaxial cell, the load cell, and the loading piston.

6.4.4 Pressure- and Vacuum-Control Devices—The chamber pressure and back pressure control devices shall be capable of applying and controlling pressures to within ± 2 psi (14 kPa) for effective consolidation pressures. The vacuum control device shall be capable of applying and controlling partial vacuums to within ± 2 psi (14 kPa). The devices may consist of self-compensating mercury pots, pneumatic pressure regulators, combination pneumatic pressure and vacuum regulators, or any other device capable of applying and controlling pressures or partial vacuums to the required tolerances.

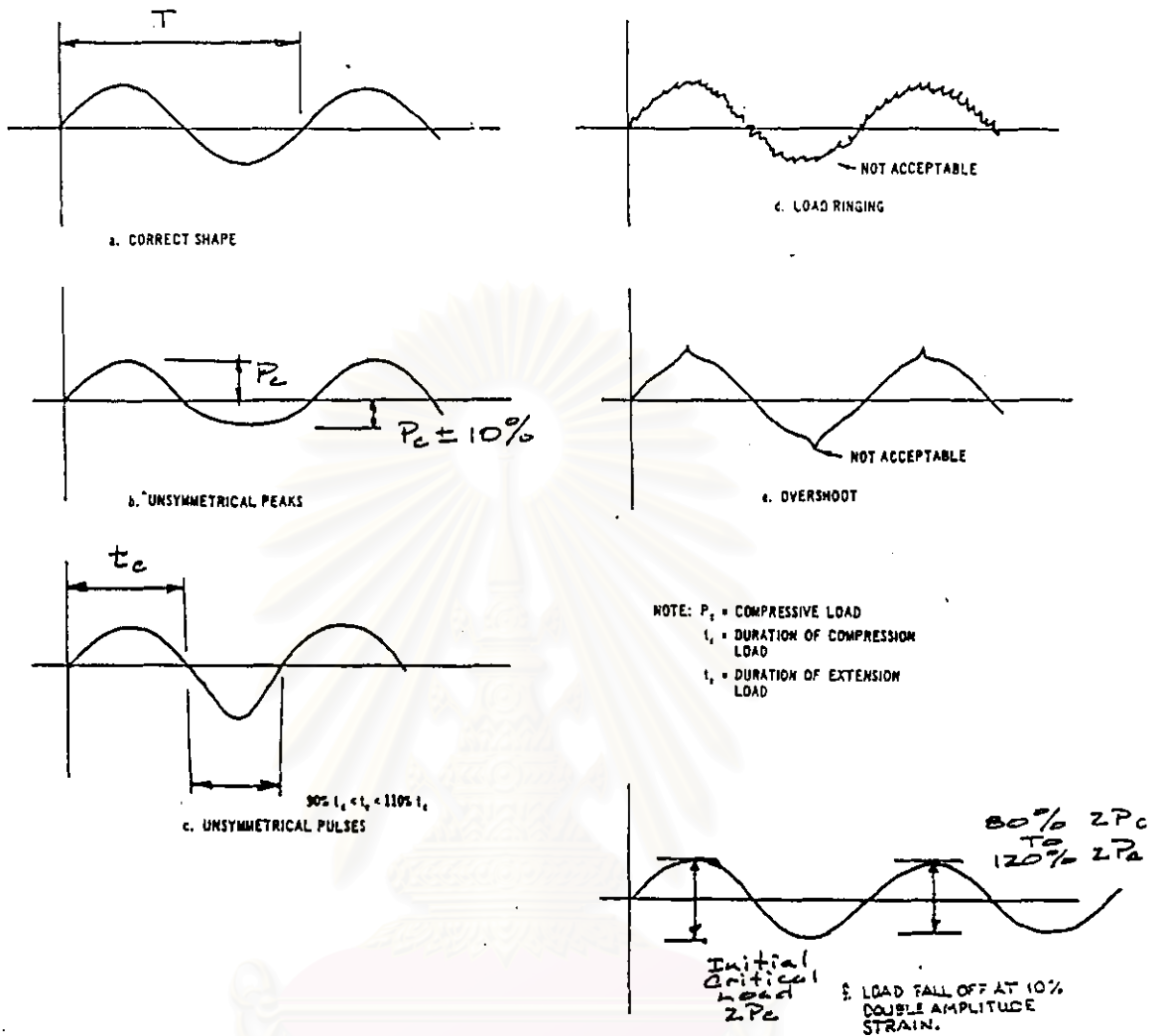

FIG. 7 Examples of Acceptable and Unacceptable Sinusoidal Loading Wave Forms For Cyclic Triaxial Load Control Tests

6.4.5 *Pressure- and Vacuum-Measurement Devices*—The chamber pressure, back pressure, and vacuum measuring devices shall be capable of measuring pressures or partial vacuums to the tolerances given in Table 1. They may consist of Bourdon gages, pressure manometers, electronic pressure transducers, or any other device capable of measuring pressures, or partial vacuums to the stated tolerances. If separate devices are used to measure the chamber pressure and back pressure, the devices must be calibrated simultaneously and against the same pressure source. Since the chamber pressure and back pressure are the pressures taken at the midheight of the specimen, it may be necessary to adjust the calibration of the devices to reflect the hydraulic head of fluid in the chamber and back pressure control systems (see Fig. 2).

6.4.6 *Pore-Water Pressure Measurement Device*—The specimen pore-water pressure shall also be measured to the tolerances given in Table 1. During cyclic loading on a saturated specimen the pore-water pressure shall be measured in such a manner that as little water as possible is allowed to go into or out of the specimen. To achieve this requirement a very stiff electronic pressure transducer must be used. With an electronic pressure transducer the pore-water pressure is read directly. The measuring device shall have a rigidity of all the assembled parts of the pore-water pressure measurement system relative to the total volume of the specimen satisfying the following requirement:

$$\frac{(\Delta v/v)}{\Delta u} < 3.2 \times 10^{-6} \text{ m}^2/\text{kN} (2.2 \times 10^{-5} \text{ in.}^2/\text{lb}) \quad (1)$$

TABLE 1 Data Acquisition, Minimum Response Characteristics for Cyclic Triaxial Strength Tests

	Load Cell	Displacement Transducer (LVDT) ^a	Pore Pressure
1. Analog Recorders Recording speeds: 0.5 to 50 cm/s (0.2 to 20 in./s) System accuracy (including linearity and hysteresis): 0.5 % ⁴ Frequency response: 100 Hz			
2. Digital Recorders Minimum Sampling Rate: 40 data points per cycle			
3. Measurement Transducers			
Minimum sensitivity, mv/v	2	0.2 mv/0.025 mm/v (AC LVDT) 5 MV/0.025 MM/V (DC LVDT)	2
Nonlinearity, % full scale	±0.25	±0.25	±0.5
Hysteresis, % full scale	±0.25	0.0	±0.5
Repeatability, % full scale	±0.10	±0.01	±0.5
Thermal effects on zero shift or sensitivity	±0.005	...	±0.02
% of full scale/°C (°F)	(±0.025)	...	(±0.01)
Maximum deflection at full rated value in mm (in.)	0.125 (0.005)
Volume change characteristics (cu in./psi)	1.0 × 10 ⁻⁴

⁴ System frequency response, sensitivity, and linearity are functions of the electronic system interfacing, the performance of the signal conditioning system used, and other factors. It is therefore a necessity to check and calibrate the above parameters as a total system and not on a component basis.

^a LVDT's, unlike strain gages, cannot be supplied with meaningful calibration data. System sensitivity is a function of excitation frequency, cable loading, amplifier phase characteristics, and other factors. It is necessary to calibrate each LVDT-cable-instrument system after installation, using a known input standard.

where:

ΔV = change in volume of the pore-water measurement system due to a pore pressure change, in.³ (mm³),

V = the total volume of the specimen, in.³ (mm³), and

Δu = the change in pore pressure, psi (kPa).

NOTE 1—To meet the rigidity requirement, tubing between the specimen and the measuring device should be short and thick walled with small bores. Thermoplastic, copper, and stainless steel tubing have been used successfully in many laboratories.

6.4.7 Volume Change Measurement Device—The volume of water entering or leaving the specimen shall be measured with an accuracy of within ±0.05 % of the total volume of the specimen. The volume measuring device is usually a burette but may be any other device meeting the accuracy requirement. The device must be able to withstand the maximum chamber pressure.

6.5 Specimen Cap and Base—The specimen cap and base shall be designed to provide drainage from both ends of the specimen. They shall be constructed of a rigid, noncorrosive, impermeable material, and each shall, except for the drainage provision, have a circular plane surface of contact with the porous discs and a circular cross section. The weight of the specimen cap and top porous disc shall be less than 0.5 % of the applied axial load at failure as determined from an undrained static triaxial test. The diameter of the cap and base shall be equal to the initial diameter of the specimen. The specimen base shall be connected to the triaxial compression chamber to prevent lateral motion or tilting, and the specimen cap shall be designed such that eccentricity of the piston-to-cap contact relative to the vertical axis of the

specimen does not exceed 0.04 D (D = diameter of specimen) as shown in Fig. 5(c). The cylindrical surface of the specimen base and cap that contacts the membrane to form a seal shall be smooth and free of scratches.

6.6 Porous Discs—The specimen shall be separated from the specimen cap and base by rigid porous discs fastened to the specimen cap and base of a diameter equal to that of the specimen. The coefficient of permeability of the discs shall be approximately equal to that of fine sand 1×10^{-3} mm/s (3.9×10^{-5} in./s). The discs shall be regularly checked by passing air or water under pressure through them to determine whether they have become clogged. Care must be taken to ensure that the porous elements of the end platens are open sufficiently so as not to impede drainage or pore water movement from specimen into the volume change or pore pressure measuring devices, and with openings sufficiently fine to prevent movement of fines out of the specimen.

NOTE 2—Filter-paper discs of a diameter equal to that of the specimen may not be placed between the porous discs and specimen to avoid clogging of the porous discs when measuring moduli values on stiff specimens.

6.7 Filter-Paper Strips—Filter-paper strips are used by many laboratories to decrease the time required for testing. If filter strips are used, they shall be of a type that does not dissolve in water. The coefficient or permeability of the filter paper shall not be less than 1×10^{-4} mm/s (3.9×10^{-6} in./s) for a normal pressure of 550 kPa (80 psi). To avoid hoop tension, filter strips should cover no more than 50 % of the specimen periphery.

NOTE 3—The filter paper given in Footnote 6 has been found to meet the permeability and durability requirements.

6.8 Rubber Membrane—The rubber membrane used to encase the specimen shall provide reliable protection against leakage. To check a membrane for leakage, the membrane shall be placed around a cylindrical form, sealed at both ends with rubber O-rings, subjected to a small air pressure on the inside, and immersed in water. If air bubbles appear from any point on the membrane it shall be rejected. To offer minimum restraint to the specimen, the unstretched membrane diameter shall be between 90 and 95 % of that of the specimen. The membrane thickness shall not exceed 1 % of the diameter of the specimen. The membrane shall be sealed to the specimen cap and base with rubber O-rings for which the unstressed inside diameter is between 75 and 85 % of the diameter of the cap and base, or by other means that will provide a positive seal.

6.9 Valves—Changes in volume due to opening and closing valves may result in inaccurate volume change and pore-water pressure measurements. For this reason, valves in the specimen drainage system shall be of the type that produce minimum volume changes due to their operation. A valve may be assumed to produce minimum volume change if opening or closing the valve in a closed, saturated pore-water pressure system does not induce a pressure change of greater than 0.7 kPa (0.1 psi). All valves must be capable of withstanding applied pressures without leakage.

⁶ Whatman's No. 54 filter paper has been found suitable for this purpose.

NOTE 4—Ball valves have been found to provide minimum volume-change characteristics; however, any other type of valve having the required volume-change characteristics may be used.

6.10 *Specimen-Size Measurement Devices*—Devices used to determine the height and diameter of the specimen shall measure the respective dimensions to within 0.1 % of the total dimension and shall be constructed such that their use will not disturb the specimen.

NOTE 5—Circumferential measuring tapes are recommended over calipers for measuring the diameter. Measure height with a dial gage mounted on a stand.

6.11 *Sample Extruder*—If an extruder is used to remove a tube sample from the sampling tube, the sample extruder shall be capable of extruding the soil core from the sampling tube at a uniform rate in the same direction of travel as the sample entered the tube and with minimum disturbance of the sample, see 7.3.2. If the soil core is not extruded vertically, care should be taken to avoid bending stresses on the core due to gravity. Conditions at the time of sample removal may dictate the direction of removal, but the principal concern is to minimize the degree of disturbance.

6.12 *Timer*—A timing device indicating the elapsed testing time to the nearest 1 s shall be used to obtain consolidation data (see 10.4.3).

6.13 *Weighing Device*—The specimen weighing device shall determine the mass of the specimen to an accuracy of within ± 0.05 % of the total mass of the specimen.

6.14 *Water Deaeration Device*—The amount of dissolved gas (air) in the water used to saturate the specimen may be decreased by boiling, by heating and spraying into a vacuum, cavitation process under a vacuum, or by any other method that will satisfy the requirement for saturating the specimen within the limits imposed by the available maximum back pressure and time to perform the test.

6.15 *Testing Environment*—The consolidation and cyclic loading portion of the test shall be performed in an environment where temperature fluctuations are less than $\pm 4^\circ\text{C}$ ($\pm 7.2^\circ\text{F}$) and there is no direct contact with sunlight.

6.16 *Miscellaneous Apparatus*—Specimen trimming and carving tools including a wire saw, steel straightedge, miter box and vertical trimming lathe, apparatus for preparing compacted specimens, membrane and O-ring expander, water content cans, and data sheets shall be provided as required.

6.17 *Recorders*—Specimen behavior may be recorded either by electronic digital or analog x-y recorders. It shall be necessary to calibrate the measuring device through the recorder using known input standards.

6.18 *Pressurizing/Flushing Panel*—A system for pressurizing the pressure cell and specimen is required. A typical piping system for this apparatus is presented in Fig. 8.

6.19 System Compliance:

6.19.1 *System*—The compliance of the loading system, consisting of all parts (top platen, bottom platen, porous stones, connections) between where the specimen deformation is monitored and the specimen shall be determined. This determination shall be under both tension and compressional loading.

6.19.2 Insert a dummy cylindrical specimen of a similar size and length to that being tested into the location normally occupied by the specimen. The Young's Modulus of the

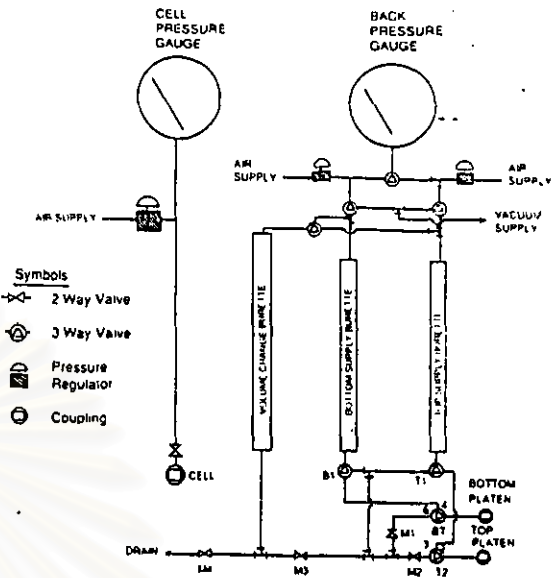

FIG. 8 Pressurizing/Flushing Panel Piping Diagram

dummy specimen should be a minimum of ten times the modulus of the materials being tested. The ends of the dummy specimen should be flat and meet the tolerances for parallelism as given in Fig. 5. Typical materials used to make dummy specimens are aluminum and steel. The dummy specimen should be rigidly attached to the loading system. This is typically accomplished by cementing the dummy specimen to the porous stones using either epoxy or hydrocement or their equivalent. Allow cement to thoroughly dry before testing.

6.19.3 Apply a static load in both tension and compression to the dummy specimen in increments up to two times the expected testing load and note the resulting deformation.

6.19.4 Use the maximum system deformation that occurs at any one load whether in tension or compression.

6.19.5 For any given loading whether in tension or compression, the minimum deformation that can be monitored and reported during an actual test is ten times the corresponding system deformation, see Note 19.

6.19.6 *Compliance Between Specimen Cap and Specimen*—Compliance can be reduced by the following methods: achieving the final desired height of reconstituted specimens by tapping and rotating the specimen cap on top of the specimen, or for both reconstituted and undisturbed specimens, fill voids between the cap and specimen with plaster of Paris, hydrostone grout, or similar material, refer to 7.3.3.

7. Test Specimen Preparation

7.1 Specimens shall be cylindrical and have a minimum diameter of 36 mm (1.4 in.). The height-to-diameter ratio shall be between 2 and 2.5. The largest particle size shall be smaller than $\frac{1}{6}$ the specimen diameter. If, after completion of the test, it is found, based on visual observation, that oversize particles are present, indicate this information in the

report of test data under remarks.

NOTE 6—Information on preserving and transporting soil samples can be found in Practices D 4220.

7.2 Take special care in sampling and transporting samples to be used for cyclic triaxial tests as the quality of the results diminishes greatly with specimen disturbance. Method D 1587 covers procedures and apparatus that may be used to obtain satisfactory undisturbed samples for testing.

NOTE 7—If oversize particles are found in the specimen after testing, a particle-size analysis performed in accordance with Method D 422 may be performed to confirm the visual observation and the results provided with the test report (see 13.1.4).

7.3 Undisturbed Specimens:

7.3.1 Undisturbed specimens may be trimmed for testing in any manner that minimizes sample disturbance, maintains the sampled density of the specimen, and maintains the initial water content. No matter what trimming method is used, the specimen ends should meet or exceed the flatness and parallelism requirement shown in Fig. 5. A procedure that has been shown to achieve these criteria for frozen specimens is as follows:

NOTE 8—If possible, prepare carved specimens in a humidity controlled room. If specimens are not prepared in a humidity-controlled room, this should be noted in the report of test data under remarks. Make every effort to prevent any change in the moisture content of the soil.

7.3.1.1 If a milling machine is available, the sample tube may be cut lengthwise at two diametrically opposite places using a rapid feed, and then cut into sections with an electric hacksaw. If a milling machine is not used, the desired section is cut with an electric hacksaw or a tube cutter with stiffening collars. The cut ends of the tube are then cleaned of burrs, and the specimen is pushed from the tube. The ends of the specimen should be trimmed smooth and perpendicular to the length using a mitre box. Care must be taken to ensure that the specimen remains frozen during the trimming operation. Place the specimen in the triaxial chamber and enclose it in a rubber membrane. Apply a partial vacuum of 35 kPa (5 psi) to the specimen and measure the specimen diameter and height according to the method given in 10.2 in order to calculate the initial volume of the specimen. After the specimen has thawed, remeasure the specimen to determine specimen conditions immediately prior to saturation. Volume change during thawing indicates that inadequate sampling or specimen preparation techniques may have been used.

7.3.2 If compression or any type of noticeable disturbance would be caused by the ejection device, split the sample tube lengthwise or cut it off in small sections to facilitate removal of the specimen with minimum disturbance.

7.3.3 Specimens shall be of uniform circular cross section with ends perpendicular to the axis of the specimen. Where pebbles or crumbling result in excessive irregularity at the ends, pack soil from the trimmings in the irregularities to produce the desired surface. An alternative procedure would be to cap the specimens with a minimum thickness of plaster of Paris, hydrostone, or similar material. In this case provisions for specimen drainage would have to be provided by holes in the cap. When sample conditions permit, a vertical

soil lathe that will accommodate the total sample may be used as an aide in carving the specimen to the required diameter.

7.4 Reconstituted Specimens:

7.4.1 *Fluviation Through Water Method*—For this specimen preparation method a granular soil is saturated initially in a container, poured through water into a water-filled membrane placed on a forming mold, and then densified to the required density by vibration, refer to reference by Chaney and Mulilis⁷.

NOTE 9—A specimen may be vibrated either on the side of the mold or the base of the cell using a variety of apparatus. These include the following: tapping with an implement of some type such as a spoon or metal rod, pneumatic vibrator, or electric engraving tool.

7.4.2 *Dry Screening Method*—For this method a tube with a screen attached to one end is placed inside a membrane stretched over a forming mold. A dry uniform sand is then poured into the tube. The tube is then slowly withdrawn from this membrane/mold allowing the sand to pass through the screen forming a specimen. If a greater density of the sand is desired the mold may be vibrated.

7.4.3 *Dry or Moist Vibration Method*—In this procedure compact oven-dried, or moist granular material in layers (typically six to seven layers) in a membrane-lined split mold attached to the bottom platen of the triaxial cell. Compact the preweighed material for each lift by vibration to the dry unit weight required to obtain the prescribed density. Scarify the soil surface between lifts. It should be noted that to obtain uniform density, the bottom layers have to be slightly undercompacted, since compaction of each succeeding layer densifies the sand in layers below it. After the last layer is partially compacted, put the top cap in place and continue vibration until the desired dry unit weight is obtained.

7.4.4 *Tamping Method*—For this procedure tamp air dry or moist granular or cohesive soil in layers into a mold. The only difference between the tamping method and the vibration method is that each layer is compacted by hand tamping with a compaction foot instead of with a vibrator, refer to reference by Ladd, R. S.⁸

7.4.5 After the specimen has been formed, place the specimen cap in place and seal the specimen with O-rings or rubber bands after placing the membrane ends over the cap and base. Then apply a partial vacuum of 35 kPa (5 psi) to the specimen and remove the forming jacket. If the test confining-pressure is greater than 103 kPa (14.7 psi), a full vacuum may be applied to the specimen in stages prior to removing the jacket.

8. Mounting Specimen

8.1 Variations in specimen setup techniques will be dependent principally on whether the specimen is undisturbed or remolded. If the specimen is undisturbed it will be trimmed and then placed in the triaxial cell. In contrast, if the specimen is remolded it can either be recompacted on or off the bottom platen of the triaxial cell. The determination of which procedure to use will depend on whether the

⁷Chaney, R., and Mulilis, J., "Wet Sample Preparation Techniques," *Geotechnical Testing Journal*, ASTM, 1978, pp. 107-103.

⁸Ladd, R. S., "Preparing Test Specimens Using Under-Compaction," *Geotechnical Testing Journal*, ASTM, Vol. 1, No. 1, March, 1978, pp. 16-23.

specimen can support itself independent of the latex rubber membrane and if it can undergo limited handling without undergoing disturbance.

8.2 *Undisturbed Specimen:*

8.2.1 Place the specimen on the bottom platen of the triaxial cell.

8.2.2 Place the top platen on the specimen.

8.2.3 Stretch a latex rubber membrane tightly over the interior surface of the membrane stretcher. Apply a vacuum to the stretcher to force the membrane against the inner surface of the stretcher and then slip the stretcher carefully over the specimen. Remove the vacuum from the membrane stretcher. Roll the membrane off the stretcher onto the top and bottom platen, see Note 10.

NOTE 10—The specimen should be enclosed in the rubber membrane and the membrane sealed to the specimen top and bottom platens immediately after the trimming operation to prevent desiccation. Alternatively, lucite plastic dummy top and bottom caps can be used until a triaxial cell is available.

8.2.4 Remove the membrane stretcher.

8.2.5 Place O-ring seals around the top and bottom platens.

8.2.6 Attach top and bottom platen pressure lines to flushing/pressurizing panel.

8.3 *Recompacted Specimen:*

8.3.1 *Dense Unsaturated Specimen*—If specimen is compacted in an apparatus separate from the triaxial cell, then treat in a manner similar to that described in 8.2.1 to 8.2.5.

8.3.2 *All Others*—Specimens that are loose unsaturated, loose saturated or dense saturated, need to be recompacted directly on the lower platen of the triaxial pressure cell. This is required to prevent specimen disturbance.

8.3.2.1 Place the latex rubber membrane on the bottom platen of the triaxial cell.

8.3.2.2 Secure an O-ring over the latex rubber membrane to seal it against the bottom platen.

8.3.2.3 Place a split mold over the bottom platen with the latex rubber membrane extending up through it.

8.3.2.4 Stretch the latex rubber membrane tightly over the interior surface of the split mold (membrane stretcher) and over its top upper lip.

8.3.2.5 Apply a vacuum to the split mold to hold the membrane tightly against the mold during the recompacting operation.

8.3.2.6 Recompact the specimen within the membrane using any of the techniques described in 7.4.

8.3.2.7 After the specimen is formed, place the top platen on the specimen and draw the latex rubber membrane up tightly over it.

8.3.2.8 Place an O-ring over the top platen to seal the latex rubber membrane against it.

8.3.2.9 Attach top and bottom platen pressure lines to flushing/pressurizing panel.

8.3.2.10 Remove the split mold. See Note 11.

NOTE 11—If the specimen is unable to support itself, it will be necessary to apply a small vacuum through a bubble chamber, see Fig. 9. A vacuum less than one half the desired final effective stress or 10 in. of Hg., whichever is less, is recommended. If bubbles continue to be present in the bubble chamber, check for leakage caused by poor connections, holes in the membrane, or imperfect seals at the top or bottom platens. Leakage through holes in the membrane can frequently be eliminated by coating the surface of the membrane with a rubber

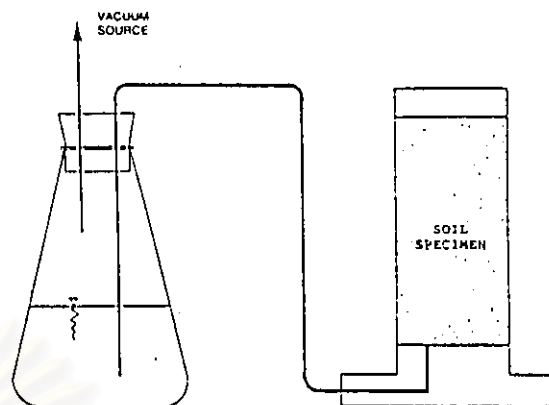

FIG. 9 Method of Applying Vacuum To Soil Samples

latex or by use of a second membrane. If bubbles are absent, an airtight seal has been obtained.

8.3.2.11 Place the cover plate on the tie rods.

8.3.2.12 Insert the loading piston through the seal assembly and connect to the top platen. It is important that the connection of the loading piston to the top platen be tight to eliminate compliance.

8.3.2.13 Place the chamber in position and fasten into position.

8.3.2.14 Place the triaxial pressure cell on the cyclic loading frame.

8.3.2.15 Place chamber fluid into pressure cell.

9. Calibration and Standardization

9.1 Two typical piston sealing arrangements employed in cyclic triaxial apparatus are shown in Fig. 10. Such arrangements are necessary if external load measurement devices are used. The linear bearing/O-ring seal is the most common, see Fig. 10. The primary difficulty with this seal is friction developed between the O-ring and the surface of the load piston. To reduce this friction two methods can be employed. These methods are over sizing the O-ring, and freezing the O-ring with electronic freon spray then thawing out and chroming the load piston. The air bearing seal arrangement produces the minimum friction on the load piston, see Fig. 10. The primary difficulty with this seal is the maintenance of the close tolerance between the slides and the load piston. Dirt and salt build-up tend to either block this zone or increase friction. Cleanliness is absolutely necessary for operation of this seal.

9.2 Triaxial cell designs to achieve requirements of platen alignment and reduce compliance are shown in Fig. 11.

9.3 Typical top platen connections that have been employed are shown in Fig. 6. The purpose of the connection is to provide a rigid fastening that is easy to assemble. The hard lock systems (see Fig. 6(a)) are necessary for testing stiff materials but require the ability to tighten the nut with a wrench. If it is not possible to employ a wrench or if testing relatively soft materials, then either a magnetic system (see Fig. 6(b)) or vacuum system (see Fig. 6(c)) can be used.

9.4 The effect of system compliance on test results is

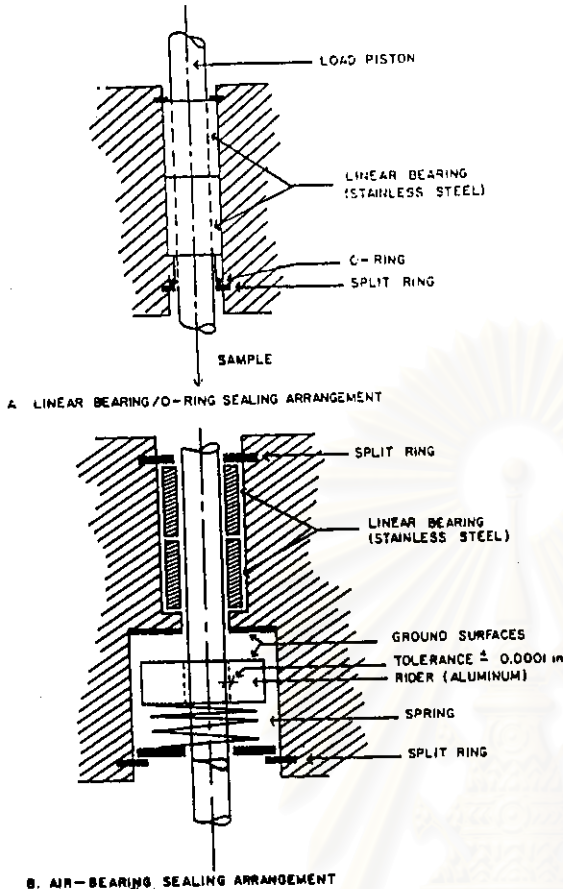

FIG. 10 Typical Cyclic Triaxial Sealing Arrangement

illustrated in Fig. 12. A review of Fig. 12 shows that as the compliance increases in the triaxial test system the deviation from the resonant column results increases. A detailed discussion of system compliance is provided in 6.19 and Note 12.

NOTE 12—Example calculation of system measurement capability. A system deformation of 0.0001 in. is measured at a given load (either tension or compression) then

$$\text{minimum system measuring capability for given load} = 0.0001 \text{ in.} \times 10 = 0.001 \text{ in.}$$

Therefore if the actual sample being tested is 5.0 in. (127 mm) long then the corresponding minimum axial strain (ϵ_a) that can be measured and reported with this system is the following:

$$\epsilon_a = \frac{0.001 \text{ in.}}{5.0 \text{ in.}} \times 100 = 2 \times 10^{-2} \%$$

10. Procedure

10.1 General—Because of the wide variety of triaxial equipment currently in use for cyclic soil testing, it is not possible to prescribe a step-by-step testing procedure that is

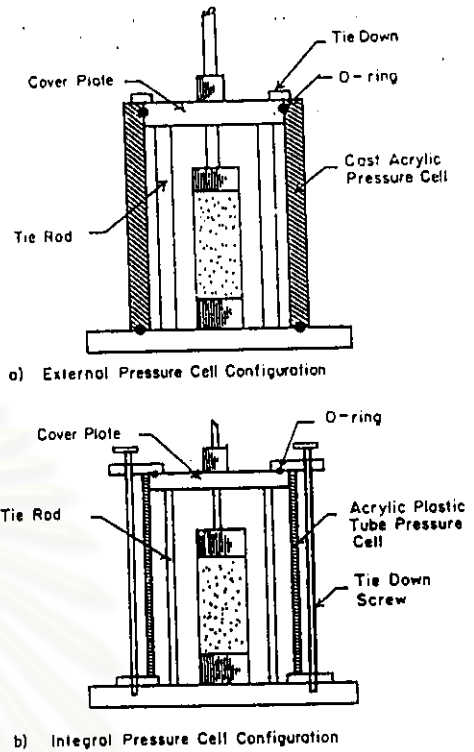

FIG. 11 Typical Design Variations in Aligned Triaxial Pressure Cells

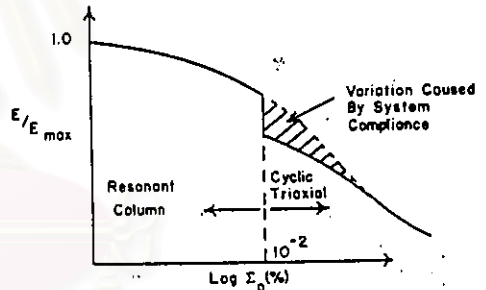

FIG. 12 Variation in Modulus Curves Caused by System Compliance

compatible with the characteristics of all equipment. The following procedures, however, will be common to any cyclic triaxial test on either saturated or unsaturated specimens.

10.2 Specimen Measurement—Because density greatly influences the cyclic triaxial strength, it is imperative that accurate density determination and volume change measurements be made during saturation and consolidation. Base the initial specimen conditions on measurements taken after the mold is removed (with the specimen under vacuum). Take diameter measurements for specimens up to 150-mm (6 in.)

using a circumferential tape to the nearest 0.025 mm (0.001 in.). For larger specimens measure to nearest 0.25 mm (0.01 in.). Take height measurements to the nearest 0.025 mm (0.001 in.) for specimens 150 mm (6 in.) or less in diameter and 0.25 mm (0.01 in.) for specimens having diameters greater than 150 mm at four locations, and measure weights to the nearest 0.01 g for specimens 63.5 mm (2.5 in.) or less in diameter and 0.1 g for specimens having diameters greater than 63.5 mm (2.5 in.). Determine water contents taken of specimens trimmings to within 0.1 % (see Method D 2216).

10.3 Saturation—If it is desired to test the specimen saturated then follow the procedure outlines in this section. If it is desired to test the specimen in an unsaturated condition then proceed to 10.4.

10.3.1 The objective of the saturation phase of the test is to fill all voids in the specimen with water without undesirable prestressing of the specimen or allowing the specimen to swell (unless the specimen will swell under the desired effective consolidation stress). Saturation is usually accomplished by applying back pressure to the specimen pore water to drive air into solution after either: applying vacuum to the specimen and dry drainage system (lines, porous discs, pore-pressure device, filter-strips or cage, and discs) and allowing de-aired water to saturate the system while maintaining the vacuum; or saturating the drainage system by boiling the porous discs in water and allowing de-aired water to flow through the system prior to mounting the specimen. It should be noted that time is required to place air into solution. Accordingly, removing as much air as possible prior to applying back pressure will decrease the amount of air that will have to be placed into solution and will also decrease the back pressure required for saturation. In addition, air remaining in the specimen and drainage system just prior to applying back pressure will go into solution much more readily if the de-aired water is used. Many procedures have been developed to accomplish saturation. For specimens to be tested under consolidation stresses exceeding 103 kPa (14.7 psi), the following procedure has been found to be effective. For specimens requiring consolidation stresses less than 103 kPa (14.7 psi) all the stresses given in 10.3.2 through 10.3.4 must be reduced to a level that will not cause overconsolidation.

10.3.2 Apply the highest available vacuum to the specimen through the specimen cap and after assembling and filling the triaxial chamber with fluid, allow de-aired water to slowly seep through the specimen from the bottom. The upward movement of water should be sufficiently slow to minimize entrapment of possible air pockets and to avoid significant prestressing of the specimen. Also take care to ensure that fines are not washed from the specimen.

10.3.3 When water appears in the buret in communication with the specimen cap, fill the remainder of the buret with de-aired water and then simultaneously reduce the vacuum and increase the chamber pressure until the specimen pore-water is at atmospheric pressure and the chamber pressure is 103 kPa (14.7 psi). Back pressure the specimen in steps, maintaining an effective confining stress of less than 103 kPa (14.7 psi). Isotropic stress conditions may be maintained during back pressuring by adding axial load to the piston according to the procedure described in 10.4.1. Evaluate the degree of saturation at appropriate intervals by

measuring Skipton's Porewater Pressure Parameter B .

10.3.4 Measurement of the Pore Pressure Parameter B —The Pore Pressure Parameter B is defined by the following equation:

$$B = \Delta u / \Delta \sigma_3 \quad (2)$$

where:

Δu = the change in the specimen pore water pressure that occurs as a result of a change in the chamber pressure when the specimen drainage valves are closed, and

$\Delta \sigma_3$ = the change in the chamber pressure.

The value of the Pore Pressure Parameter B shall be determined as follows:

10.3.4.1 Close the specimen drainage valves and increase the chamber pressure 35 kPa (5 psi).

NOTE 13—The amount of increase in chamber pressure should be less than the desired effective stress.

10.3.4.2 After approximately 2 min determine and record the maximum value of the induced pore pressure. For many specimens, the pore pressure may decrease after the immediate response and then increase slightly with time. If this occurs, values of Δu should be plotted with time and the asymptotic pore pressure used as the change in pore pressure. A large increase in Δu with time with values of Δu greater than $\Delta \sigma_3$ may indicate a leak of chamber fluid into the specimen. Decreasing values of Δu with time may indicate a leak in that part of the pore pressure measurement system located outside the chamber or incomplete saturation.

10.3.4.3 Calculate the B value using the equation given in 10.3.4.

10.3.4.4 Reapply the same confining pressure (chamber pressure minus back pressure) as existed prior to the B -value by reducing the chamber pressure by 35 kPa (5 psi) or by alternatively, increasing the back pressure by 35 kPa (5 psi). If B is continuing to increase with increasing back pressure continue with back pressure saturation. If B is equal to or greater than 0.95 or if a plot of B versus back pressure indicates no further increase in B with increasing back pressure, initiate consolidation.

10.4 Consolidation—The objective of the consolidation phase of the test is to allow the specimen to reach equilibrium in a drained state under the effective consolidation stress for which a test is required. During consolidation, data is obtained for use in determining when consolidation is complete.

10.4.1 During the consolidation process, measure the change in height of the specimen to the nearest 0.025 mm (0.001 in.). In addition, during consolidation an axial load must be applied to the piston (that is screwed into the top cap) in order to compensate for the uplift force on the load rod so that the specimen is maintained in an isotropic or other known state of stress. The static load to maintain an isotropic condition can be calculated from the following equation:

$$P_s = \sigma_3 A_r - M \quad (3)$$

where:

M = mass of the load rod and top platen,

P_s = static piston correction load,

σ_3 = cell pressure, and

A_r = cross sectional area of the load rod.

D 3999

10.4.2 With the specimen drainage valves closed, hold the maximum back pressure constant and increase the chamber pressure until the difference between the chamber pressure and the back pressure equals the desired effective consolidation pressure.

NOTE 14—In cases where significant amounts of fines may be washed from the specimen because of high initial hydraulic gradients, it is permissible to gradually increase the chamber pressure to the total desired pressure over a period of up to 10 min with the drainage valves open. If this is done, recording of data should begin immediately after the total pressure is reached.

NOTE 15—In certain circumstances, consolidation in stages may be desirable, especially when radial drainage is used.

10.4.3 Obtain an initial burette reading and then open appropriate drainage valves so that the specimen may drain from both ends into the burette, see 6.4.6. At increasing intervals of elapsed time (0.1, 0.2, 0.5, 1, 2, 4, 8, 15 and 30 min and at 1, 2, 4, and 8 h, etc.) observe and record the burette readings and after the 15-min reading record the accompanying deformation indicator readings obtained by carefully coupling the piston with the specimen cap. If burette and deformation indicator readings are to be plotted against the square root of time, the time intervals at which readings are taken may be adjusted to those that have easily obtained square roots, for example, 0.09, 0.25, 0.49, 1, 4, 9 min, etc. Depending on soil type, time intervals may be changed to convenient time intervals that allow for adequate definition of volume change versus time.

10.4.4 Plot the burette and deformation indicator readings versus either the logarithm or square root of elapsed time. If the readings are plotted versus the logarithm of elapsed time, allow consolidation to continue for at least one log cycle of time or one overnight period after a marked reduction in the slope shows that 100 % primary consolidation has been achieved. If the readings are plotted versus the square root of elapsed time, allow consolidation to continue at least 2 h after 100 % primary consolidation has been achieved. A marked deviation between the slopes of the burette and deformation indicator curves toward the end of consolidation based on deformation indicator readings indicates leakage of fluid from the chamber into the specimen and the test should be terminated.

10.4.5 Determine the time for 50 % primary consolidation, t_{50} , in accordance with one of the procedures outlined in Test Method D 2435.

10.5 Cyclic Loading or Deformation:

NOTE 16—A soil material typically behaves like an elastic solid exhibiting a non-destructive response to the application of cyclic loading below a threshold shearing strain level of $<10^{-2}$ %. Above this strain level the response of the specimen is either elastoplastic or plastic and therefore destructive. The actual threshold strain level is dependent upon the initial stiffness of the specimen. A material that is soft will have a higher threshold strain while a stiff material will have lower threshold strain. To develop a curve of modulus and damping versus strain requires either a series of specimens be tested each at a specific strain level or a single specimen to undergo staged loading. Staged loading involves the application of progressively increasing levels of either cyclic load or deformation. At each level or stage of cyclic load or deformation perform a test sequence as described in 10.5.1 to 10.5.3. After the operation as described in 10.5.3 has been completed the operator at the direction of the engineer may then either open the specimen drainage valves to re-establish the effective consolidation stress or maintain the existing excess pore water pressure before moving on to the next higher cyclic load or deformation level.

10.5.1 For constant cyclic load (see Test Method A) estimate the magnitude of cyclic load to be applied for the desired stress ratio, SR , with the following equation:

$$P_c = 2 \times \sigma'_{3c} \times SR \times A_c \quad (4)$$

where:

P_c = estimated cyclic load to be applied to the specimen,
 σ'_{3c} = consolidated pressure (chamber pressure minus back pressure),

SR = desired stress ratio ($\pm \sigma_d$)/($2\sigma'_{3c}$), and

A_c = area of specimen after consolidation, see Note 17.

NOTE 17—Refer to 12.2.2 for procedures to calculate A_c .

10.5.2 For constant cyclic deformation (see Test Method B) select a desired single amplitude shear strain (ϵ_{SA}) and calculate the required axial strain (ϵ_{SA}) using Eq. 13. Determine the resulting single amplitude deformation using the following:

$$L_{SA} = \epsilon_{SA} \times L_s \quad (5)$$

where:

L_{SA} = single amplitude deformation, in. (m),

ϵ_{SA} = single amplitude axial strain (dimensionless), and

L_s = length of test samples, in. (m).

10.5.3 Form a large air pocket at the top of the triaxial chamber by draining water from the cell without allowing the cell pressure to drop. The air pocket is required so that piston movement in and out of the chamber during cyclic loading or cyclic deformation does not create chamber pressure fluctuations.

10.5.4 Close drainage valves to the specimen and cyclically load the specimen through 40 cycles with the first half cycle in compression using 0.5 to 1 Hz sinusoidal load or deformation extension values.

10.5.5 During cyclic loading or cyclic deformation keep the cell pressure constant and record the axial load, axial deformation, and if applicable the change in pore-water pressure with time.

10.5.6 Under load control soft to medium stiff soils will undergo a permanent deformation. The permanent deformation is caused typically by either a slightly unbalanced cyclic load or anisotropic consolidation, (see 10.4). As a result of this compression a plot of load versus deformation (Δ), as shown schematically in Fig. 13 (hysteresis loops), will tend to move along the deformation axis. Because the determination of Young's Modulus and damping at any strain level depend on the ability to identify a distinct hysteresis loop it is necessary to restrict the maximum closure error (Δ_c) between two successive peaks as shown in Fig. 13 to 0.0001 in. For a 127 mm (5 in.) long sample this corresponds to an

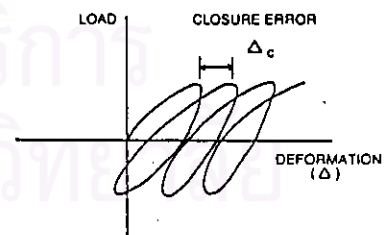

FIG. 13 Definition of Closure Error

axial strain of 0.2 %. If the closure error exceeds this value the data is not valid.

10.5.7 For staged loading return to either 10.5.1 or 10.5.2, as appropriate.

11. Specimen Removal

11.1 Following cyclic testing perform the following steps:

11.1.1 Remove the axial load from the load piston and reduce the chamber and back pressure to zero.

11.1.2 Close specimen drainage valves.

11.1.3 With the specimen drainage valves remaining closed, quickly remove the specimen from the apparatus so that the specimen will not have time to absorb water from the porous disc.

11.1.4 Remove the rubber membrane (and the filter-paper strips or cage from the specimen if they were used) and determine the water content of the total specimen in accordance with the procedure outlined in Method D 2216. (Free water remaining on the specimens of cohesive soils after removal of the membrane should be blotted away before obtaining the water content.) In cases where there is insufficient material from trimmings for index property tests, that is, where specimens have the same diameter as the sampling tube, the specimen should be weighed prior to removing material for index property tests and a representative portion of the specimen used to determine its final water content. Prior to placing the specimen (or portion thereof) in the oven to dry, sketch a picture or take a photograph of the specimen.

12. Calculation

12.1 *Initial Specimen Properties*—Using the dry mass of the total specimen, calculate and record on the appropriate data sheet the initial water content, volume of solids, initial void ratio, initial degree of saturation, and initial dry unit weight. Calculate the specimen volume from values measured in 6.10. Calculate the volume of solids by dividing the dry mass of the specimen by the specific gravity of the solids and dividing by the density of the water. Calculate void ratio by dividing the volume of voids by the volume of solids where the volume of voids is assumed to be the difference between the specimen volume and the volume of solids. Calculate dry unit weight by dividing the dry mass of the specimen by the specimen volume.

NOTE 18—The specific gravity of solids can be determined in accordance with Test Method D 854 or it may be assumed based on previous test results.

12.2 *Specimen Properties After Consolidation:*

12.2.1 Calculate the specimen height and area after consolidation as follows:

$$H_c = H_o - \Delta H \quad (6)$$

where:

H_o = initial height of specimen, mm (in.), and

ΔH = change in height of specimen at end of consolidation, mm (in.).

12.2.2 The cross-sectional area of the specimen, after consolidation, A_c , shall be computed using one of the following methods (assuming consistent units are used). The choice of the method to be used depends on whether shear data are being computed before the test is performed (in that

case Test Method A would be used) or on which of the two test methods in the opinion of a qualified person yield specimen conditions considered to be most representative of those after consolidation.

12.2.2.1 *Test Method A:*

$$A_c = (V_o - \Delta V_{sat} - \Delta V_c) / H_c \quad (7)$$

where:

V_o = initial volume of specimen, mm³ (in.³),

ΔV_{sat} = change in volume of specimen during and saturation, mm³ (in.³).

$$\Delta V_{sat} = 3V_o \Delta H_s / H_o$$

where:

ΔH_s = change in height of specimen during saturation, mm (in.), and

ΔV_c = change in volume of specimen during consolidation as indicated by burette readings, mm³ (in.³).

12.2.2.2 *Test Method B:*

$$A_c = (V_{wf} + V_s) / H_c \quad (8)$$

where:

V_{wf} = final volume of water (based on final water content), mm³ (in.³),

V_s = volume of solids, mm³ (in.³),

$$V_s = m_s / (G_s \rho_w)$$

where:

m_s = specimen dry mass, kN (lb),

G_s = specific gravity of solids, and

ρ_w = density of water, mg/m³ (lb/in.³).

12.2.3 Using the calculated dimensions of the specimen after consolidation and assuming that the water content after consolidation is the same as the final water content, calculate the consolidated void ratio and degree of saturation.

NOTE 19—In this test method, the equations are written such that compression and consolidation are considered positive.

12.3 *Hysteresis Loop Calculations*—Calculations are performed on each individual hysteresis loop using the form shown in Fig. 14 or its equivalent.

12.3.1 Calculate the material damping ratio (D) for a given hysteresis loop using Eq. (9) and record these values on Fig. 10:

$$D = \frac{A_L}{4\pi A_T} \times 100 \quad (9)$$

where:

A_L = area of hysteresis loop,

A_T = area of shaded right triangle shown in Fig. 1, and

D = material damping ratio, %.

12.3.2 Calculate the Young's Modulus (E) for a given hysteresis loop using Eq. 10 and record these values on Fig. 10:

$$E = \frac{L_{DA}}{S_{DA}} \times \frac{L_s}{A_s} \quad (10)$$

where:

L_{DA} = double amplitude load, kN (lb),

S_{DA} = double amplitude deformation, mm (in.),

L_s = height of specimen after consolidation, mm (in.),

A_s = area of specimen after consolidation, mm² (in.²), and

E = Young's Modulus, kPa (lb/in.²).

12.3.3 Calculate the single amplitude axial strain (ϵSA) for

**MODULUS/DAMPING DETERMINATION
(CYCLIC TRIAXIAL)**

TEST NUMBER _____ RUN _____
 SERIES NUMBER _____ STAGE _____
 SAMPLE NUMBER _____ L₁ _____ IN
 CALCULATOR BY _____ DATE _____ d₁ _____ IN²

DAMPING

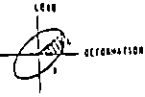
$\Delta \epsilon = \text{LOOP AREA} \times 10^{-10}$  DEFORMATION

$\Delta \epsilon = \frac{1}{2} \times L_1 \times \frac{1}{L_2} \times L_3$

$D = \frac{\Delta \epsilon}{\epsilon_{SA}} = \frac{\Delta \epsilon}{L_1 \times L_2}$

MODULUS

$E_{100} = \frac{L_1 \times L_2 \times L_3}{L_1 \times L_2} \times \frac{1}{L_3} = \frac{1}{L_3}$

$E = \frac{1}{L_1 \times L_2} \times \frac{1}{L_3} = \frac{1}{L_1 \times L_2 \times L_3}$

$G = \frac{1}{2} (1 + \mu) = \frac{1}{2} (1 + \mu)$

DEFORMATION

$\epsilon_{SA} = \frac{1}{2} \times \frac{1}{L_1} = \frac{1}{2L_1}$

$\epsilon_{SA} = \frac{1}{2} \times \frac{1}{L_1} = \frac{1}{2L_1}$

$\epsilon_{SA} = \frac{1}{2} \times \frac{1}{L_1} = \frac{1}{2L_1}$

FIG. 14 Cyclic Triaxial Modulus/Damping Calculation Form

a given hysteresis loop using Eqs. (11) and (12) and record these values in Fig. 10:

$$\epsilon_{DA} = S_{DA}/L_5 \tag{11}$$

$$\epsilon_{SA} = \epsilon_{DA}/2 \tag{12}$$

where:
 ϵ_{DA} = double amplitude axial strain (dimensionless), and
 ϵ_{SA} = single amplitude axial strain (dimensionless).

13. Report

- 13.1 Report the following information:
 13.1.1 Identification data and visual description of specimen, including soil classification in accordance with Prac-

tice D 2488 and whether the specimen is undisturbed, or remolded (indicate preparation method). Indicate if any method was employed to reduce end restraint.

13.1.2 Values of plastic limit and liquid limit, if determined in accordance with Test Method D 4318.

13.1.3 Value of specific gravity of solids and notation if the value was determined in accordance with Method D 854 or assumed.

13.1.4 Particle-size analysis, if determined in accordance with Method D 422.

13.1.5 Initial specimen dry unit weight, void ratio, water content, and degree of saturation.

13.1.6 Initial height and diameter of specimen.

13.1.7 Method followed for specimen saturation (that is, dry or wet method).

13.1.8 Total back pressure.

13.1.9 The Pore Pressure Parameter B at the end of saturation.

13.1.10 Effective consolidation stress.

13.1.11 Time to 50 % primary consolidation.

13.1.12 Specimen dry unit weight, void ratio, water content, and degree of saturation after consolidation.

13.1.13 Specimen cross-sectional area after consolidation and method used for determination.

13.1.14 Hysteresis loop for each load or strain level at cycles number 1 through 5, 10, 20, and 40.

13.1.15 Plot of Young's Modulus E and material damping D versus the logarithm of single amplitude axial strain using data from cycle Number 1 unless requested otherwise.

13.1.16 Sketch or photograph of the specimen after testing.

13.1.17 Remarks and notations regarding any unusual conditions or other information necessary to properly interpret the results obtained, including any departures from the procedure outlined.

14. Precision and Bias

14.1 The variability of soil and resultant inability to determine a true reference value prevent development of a meaningful statement of bias. Data are being evaluated to determine the precision of this test method. In addition, the subcommittee is seeking pertinent data from users of this test method.

15. Keywords

15.1 damping; laboratory test; physical properties; triaxial stress

The American Society for Testing and Materials takes no position respecting the validity of any patent rights asserted in connection with any item mentioned in this standard. Users of this standard are expressly advised that determination of the validity of any such patent rights, and the risk of infringement of such rights, are entirely their own responsibility.

This standard is subject to revision at any time by the responsible technical committee and must be reviewed every five years and if not revised, either reapproved or withdrawn. Your comments are invited either for revision of this standard or for additional standards and should be addressed to ASTM Headquarters. Your comments will receive careful consideration at a meeting of the responsible technical committee, which you may attend, if you feel that your comments have not received a fair hearing you should make your views known to the ASTM Committee on Standards, 1916 Race St., Philadelphia, PA 19103.

จุฬาลงกรณ์มหาวิทยาลัย



ประวัติผู้เขียน

นายพิพัฒน์ ทองฉิม เกิดวันที่ 13 สิงหาคม 2515 ที่อำเภอชะอวด จ.นครศรีธรรมราช สำเร็จการศึกษาปริญญาตรีวิศวกรรมศาสตรบัณฑิต ภาควิชาวิศวกรรมโยธา คณะวิศวกรรมศาสตร์ มหาวิทยาลัยสงขลานครินทร์ ในปีการศึกษา 2537 และเข้าศึกษาต่อในหลักสูตรวิศวกรรมศาสตรมหาบัณฑิต ที่จุฬาลงกรณ์มหาวิทยาลัย เมื่อ พ.ศ. 2539



สถาบันวิทยบริการ
จุฬาลงกรณ์มหาวิทยาลัย