

Chapter 4.



Wind Tunnel Experiment

4.1 Aerodynamic Characteristic Experiment

The relation of C_L and C_D for each type of airfoils was found by using a low speed wind tunnel. Figure 4.1 to 4.6 show the details of wind tunnel and its components.

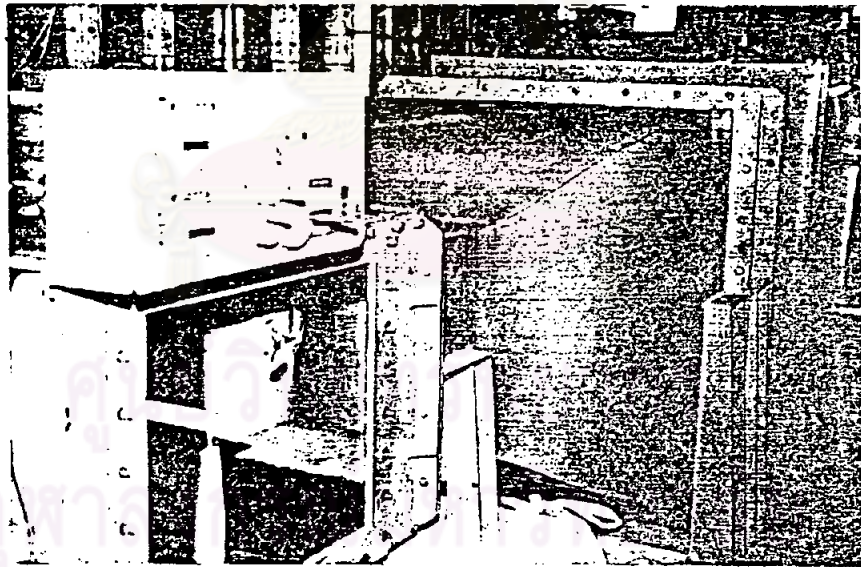

Fig. 4.1 Wind tunnel at test section

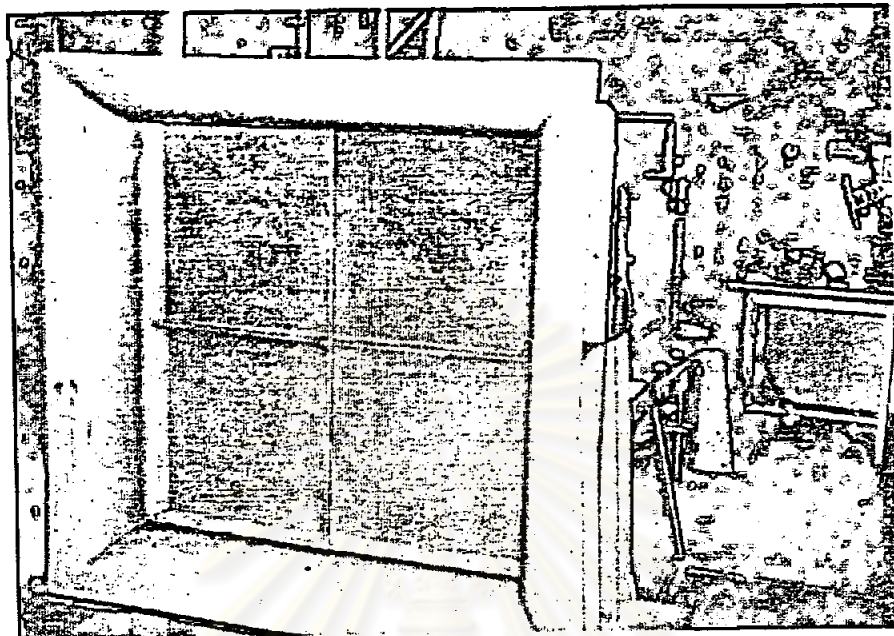

Fig.4.2 Wind tunnel at inlet

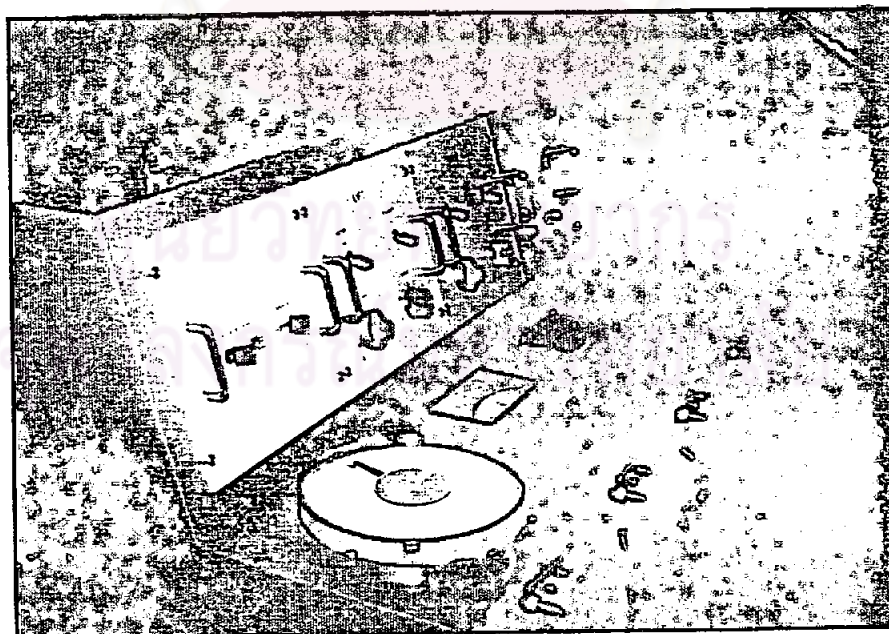

Fig.4.3 Instruments for measure of lift and drag forces

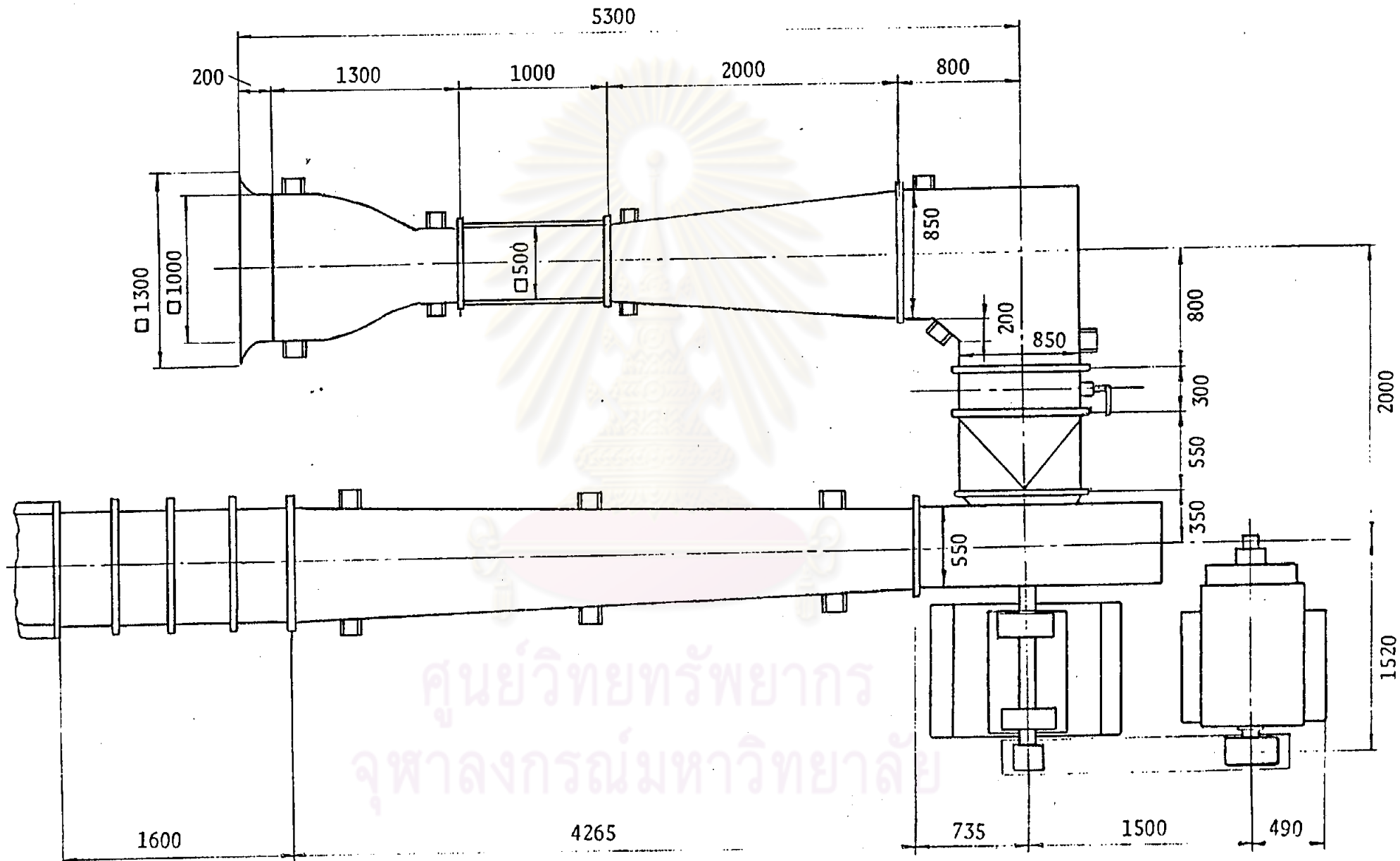

Fig.4.4 Dimensions of wind tunnel

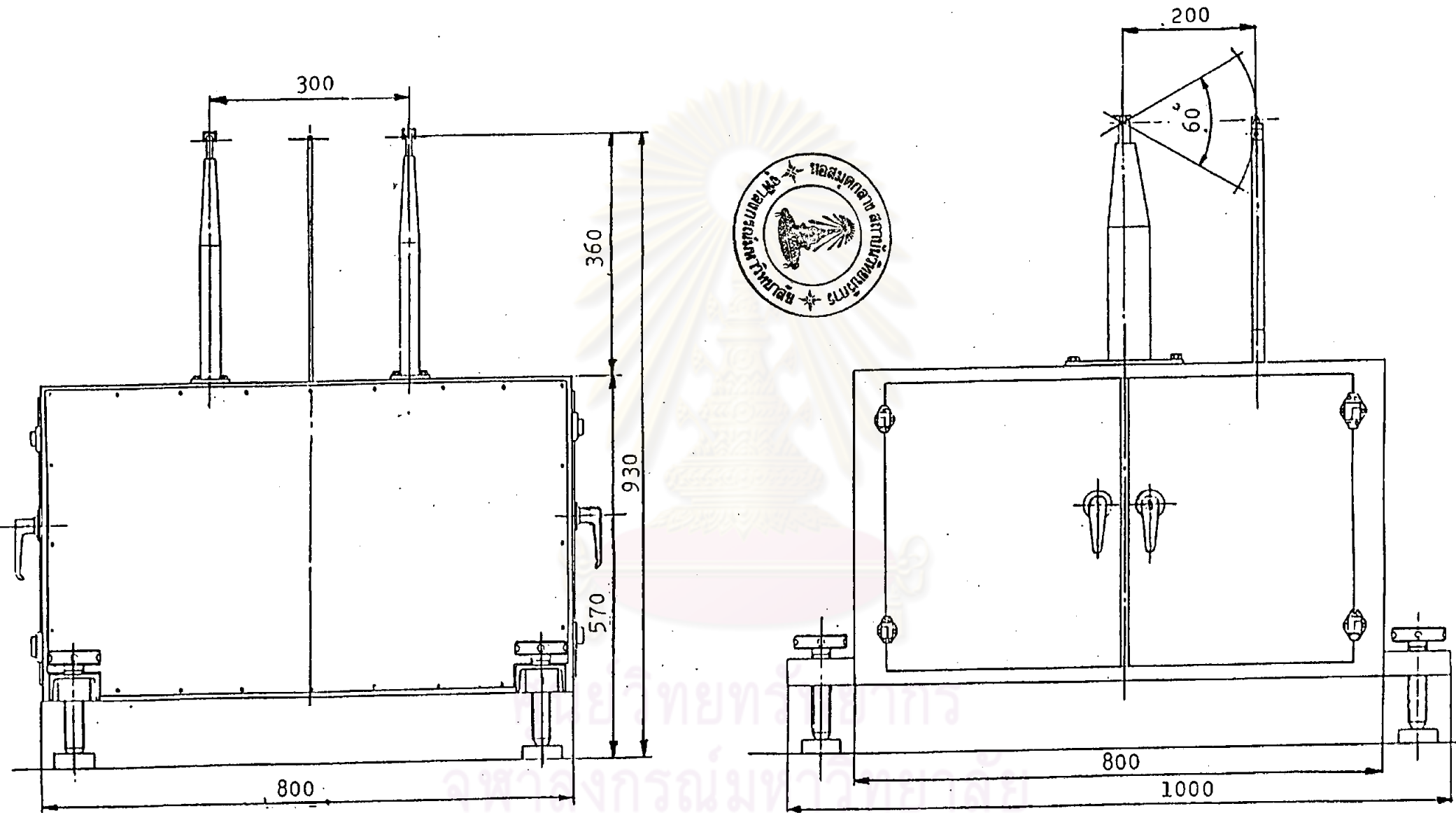

Fig. 4.5

support column

Specifications

	measure range	accuracy
Lift force	$\pm 4 . \pm 2 . \pm 1 . \pm 0.4$ kg	0.5-1.0 %
Drag force	$\pm 2 . \pm 1 . \pm 0.4 . \pm 0.2$ kg	0.5-1.0 %

Fig.4.6 Specifications of wind tunnel

Attack angle range is from -30 to +30 degrees

Test section size is 500X500 mm

Before commencing this experiment the velocity distribution at the test section was measured for a range of Reynolds numbers as shown in Figs.4.7 to 4.12.

ศูนย์วิทยทรัพยากร
จุฬาลงกรณ์มหาวิทยาลัย

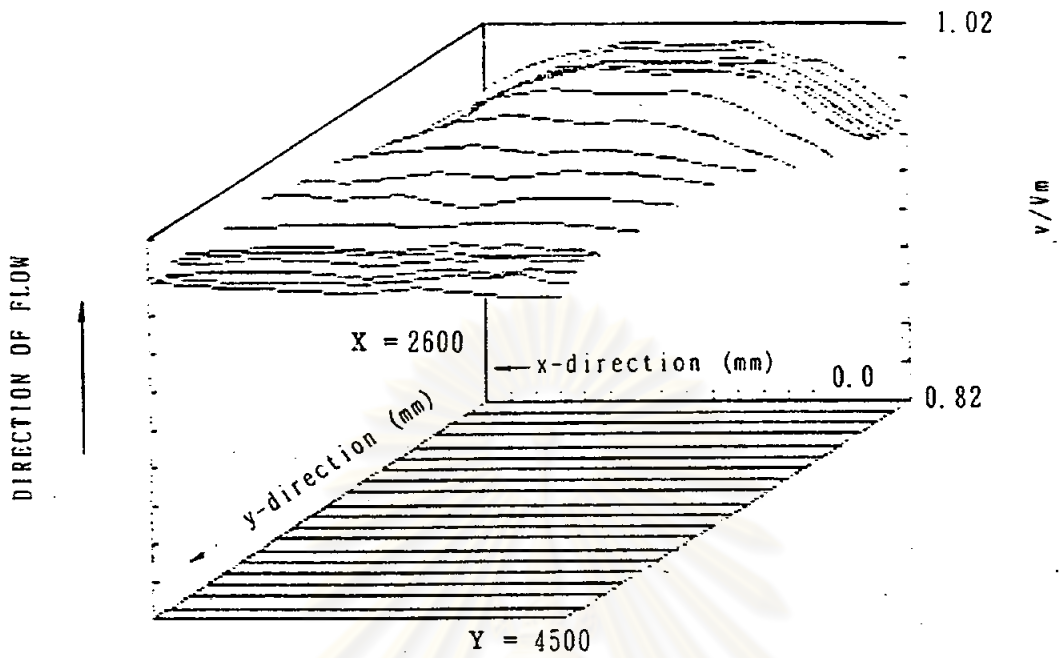

Fig. 4.7 Velocity distribution at test section ($V = 10$ m/s)

V_m = Mean velocity at center of test section

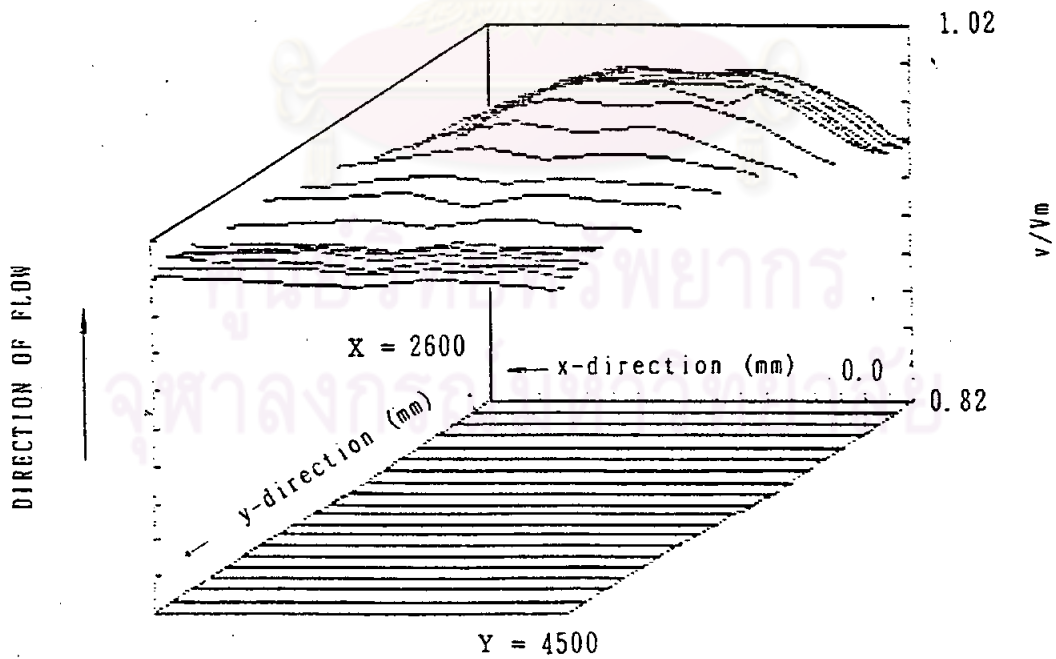

Fig. 4.8 Velocity distribution at test section ($V = 15$ m/s)

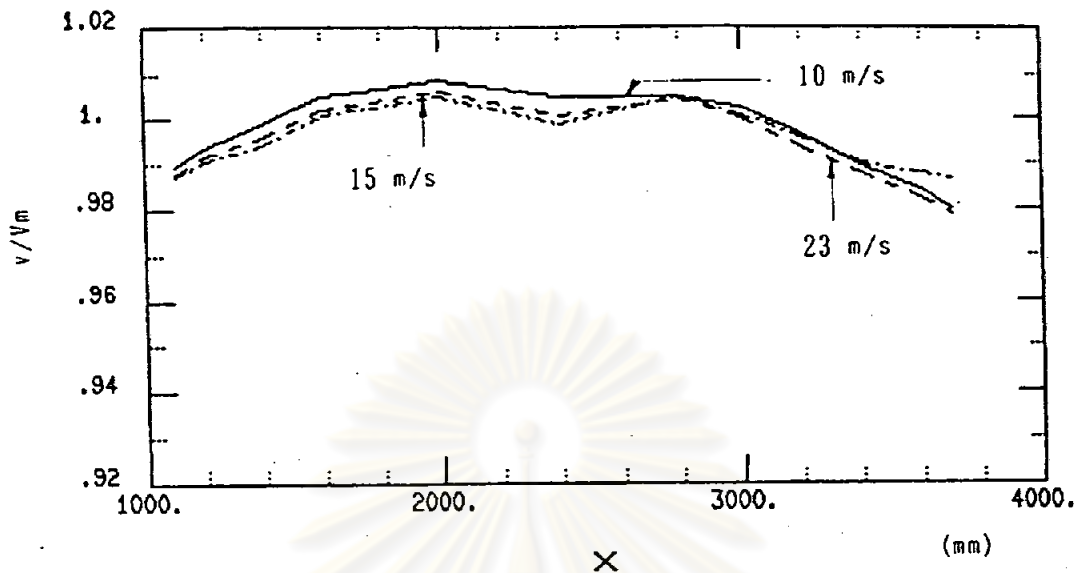

Fig.4.9 Comparison of velocity distribution at test section (Y = 1500)

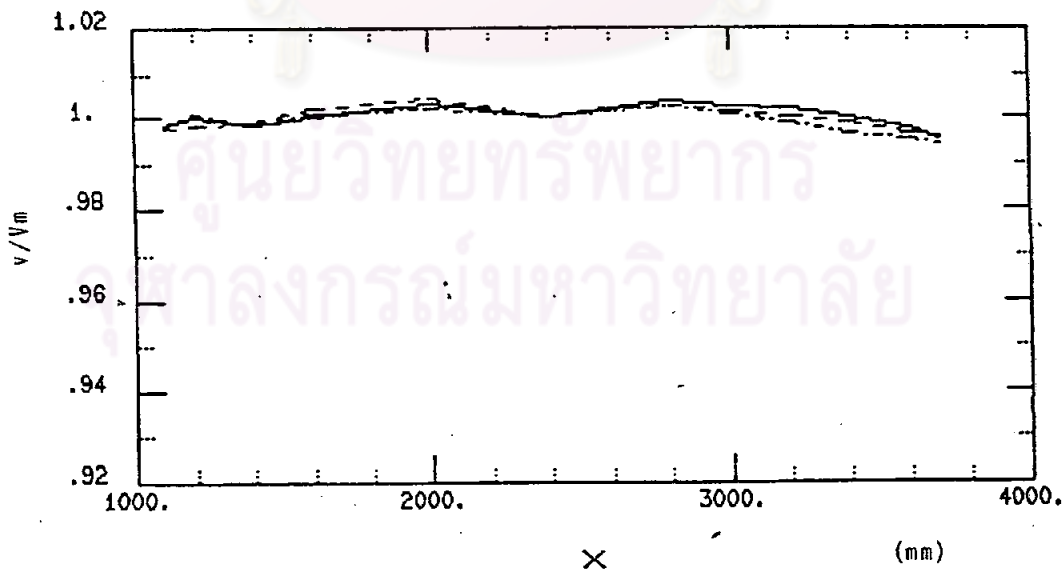

Fig.4.10 Comparison of velocity distribution at test section (Y = 2500)

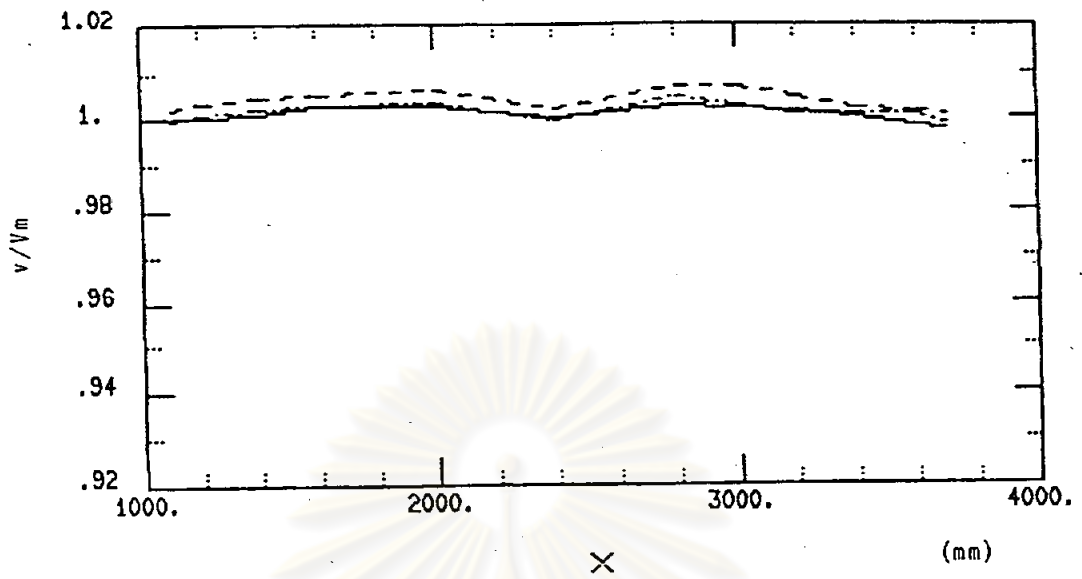

Fig. 4.11. Comparison of velocity distribution at test section
($Y = 3500$)

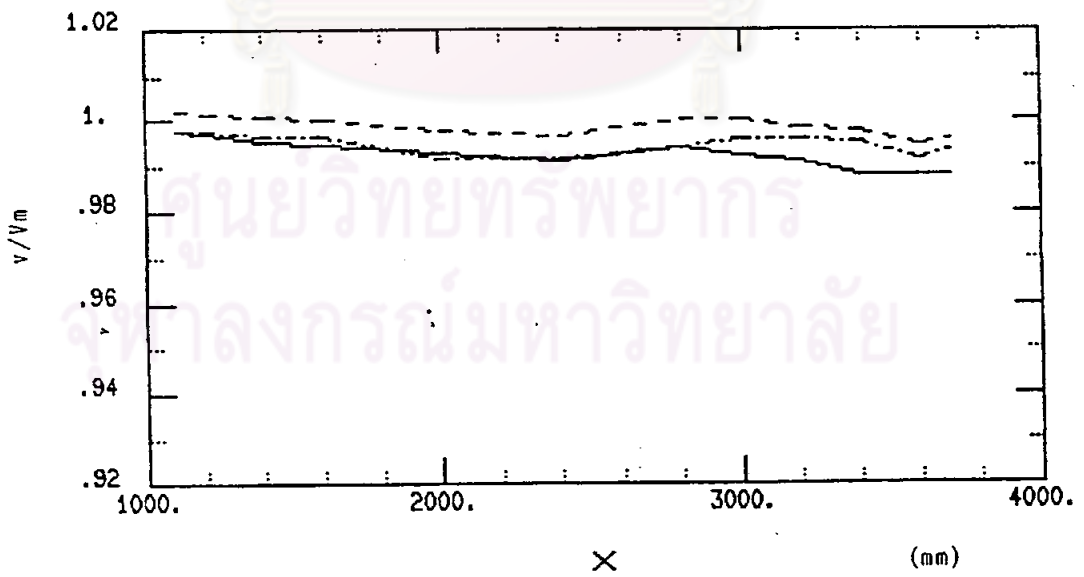
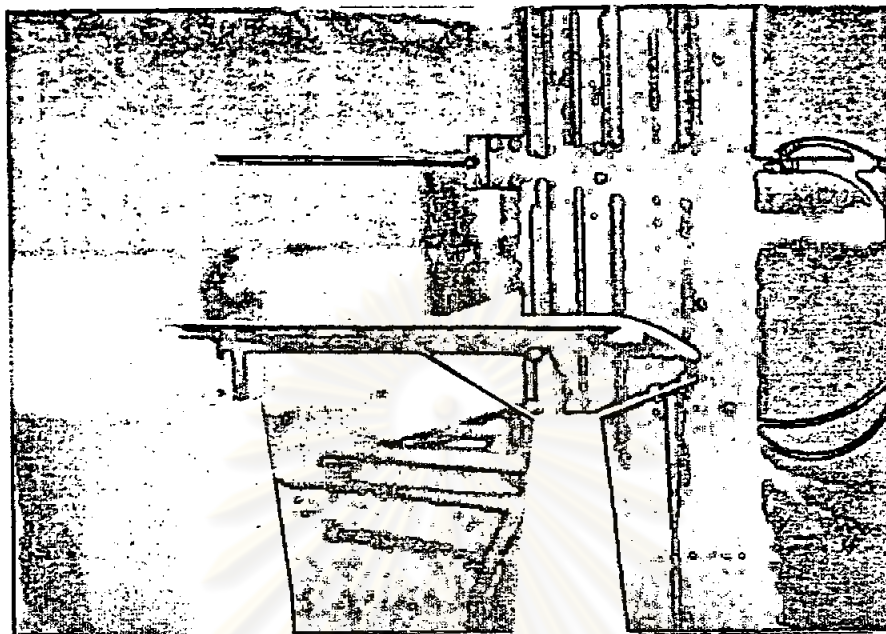

Fig. 4.12. Comparison of velocity distribution at test section
($Y = 4500$)

The test was done at Reynolds numbers in the range of 40,000 to 90,000 for the airfoil model whose chord length is 60-70 mm and aspect ratio about 7⁽⁸⁾. X-Y recorder was used to record the values of lift and drag in relation to attack angle, (rate of change of attack angle = 2.399×10^{-3} rad/s or 0.137 deg/s). The details of testing such as model setting and testing section are shown in Figs.4.13 and 4.14.

4.2 Type of Models

Since one of the present study aims is for a simple construction, 7 types of simple airfoils section as shown in Figs.4.16 to 4.22 were selected and tested with airfoil NACA 4418 as shown in Fig.4.15, to compare the aerodynamic characteristics of each airfoil.



(a) Front view

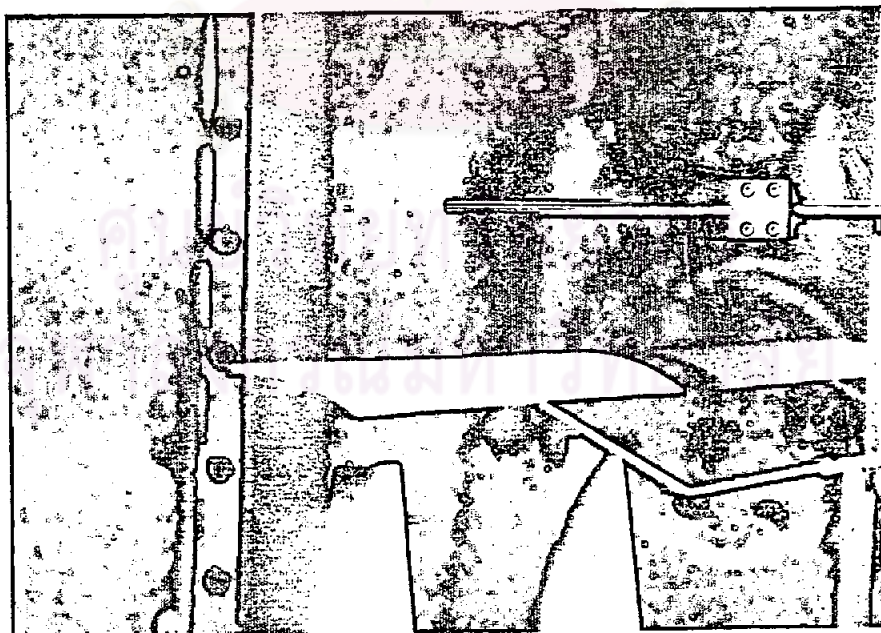

(b) Back view

Fig. 4.13 (a), (b) Model setting at test section (Arched plate)

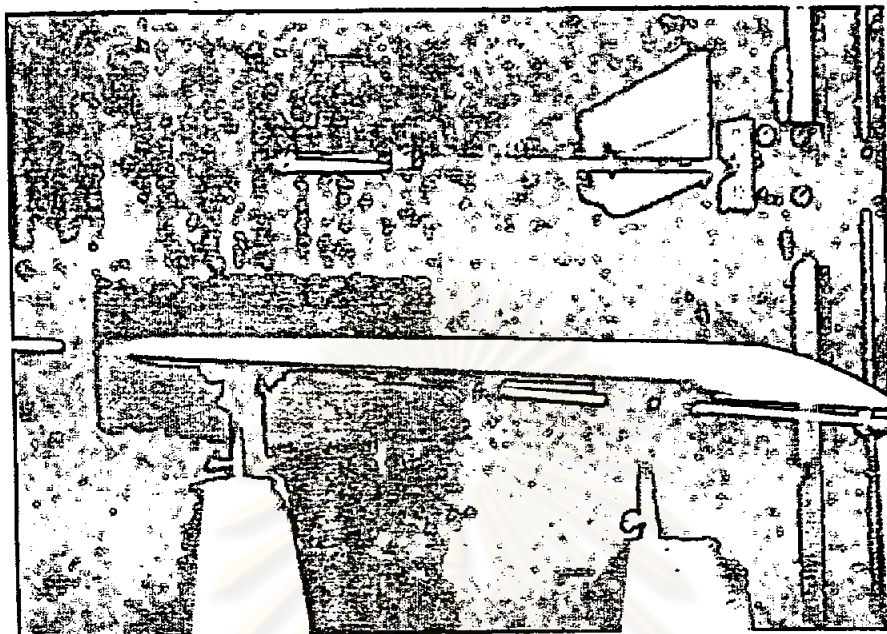

(a) Front view

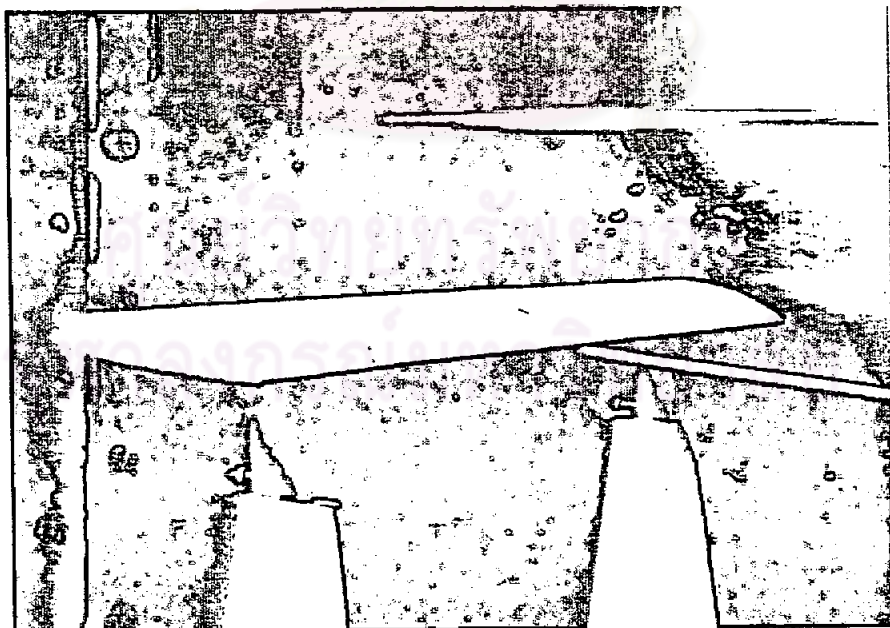

(b) Back view

FIG. 4.14 (a). (b) Model setting at test section (NACA 4418)

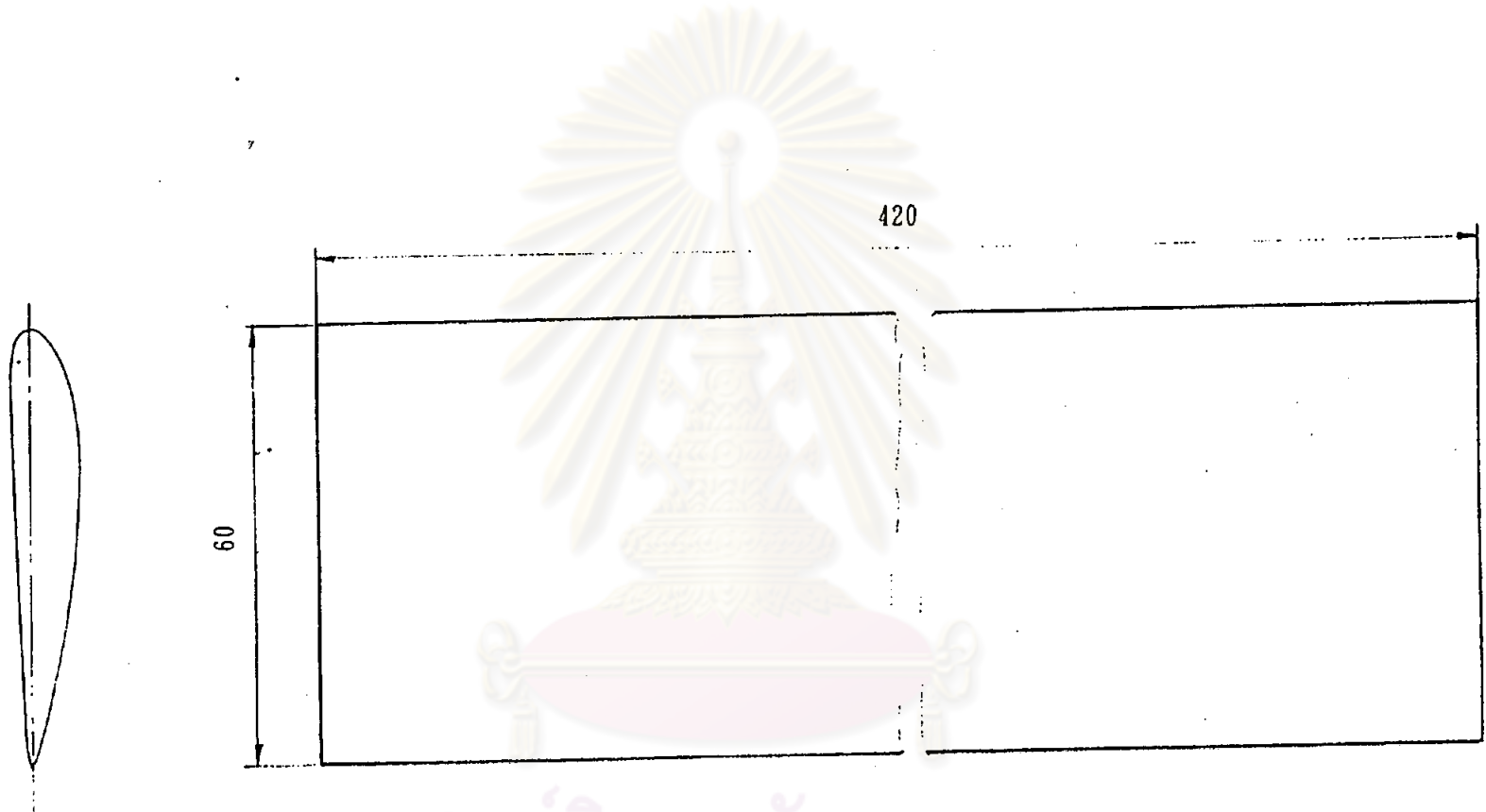
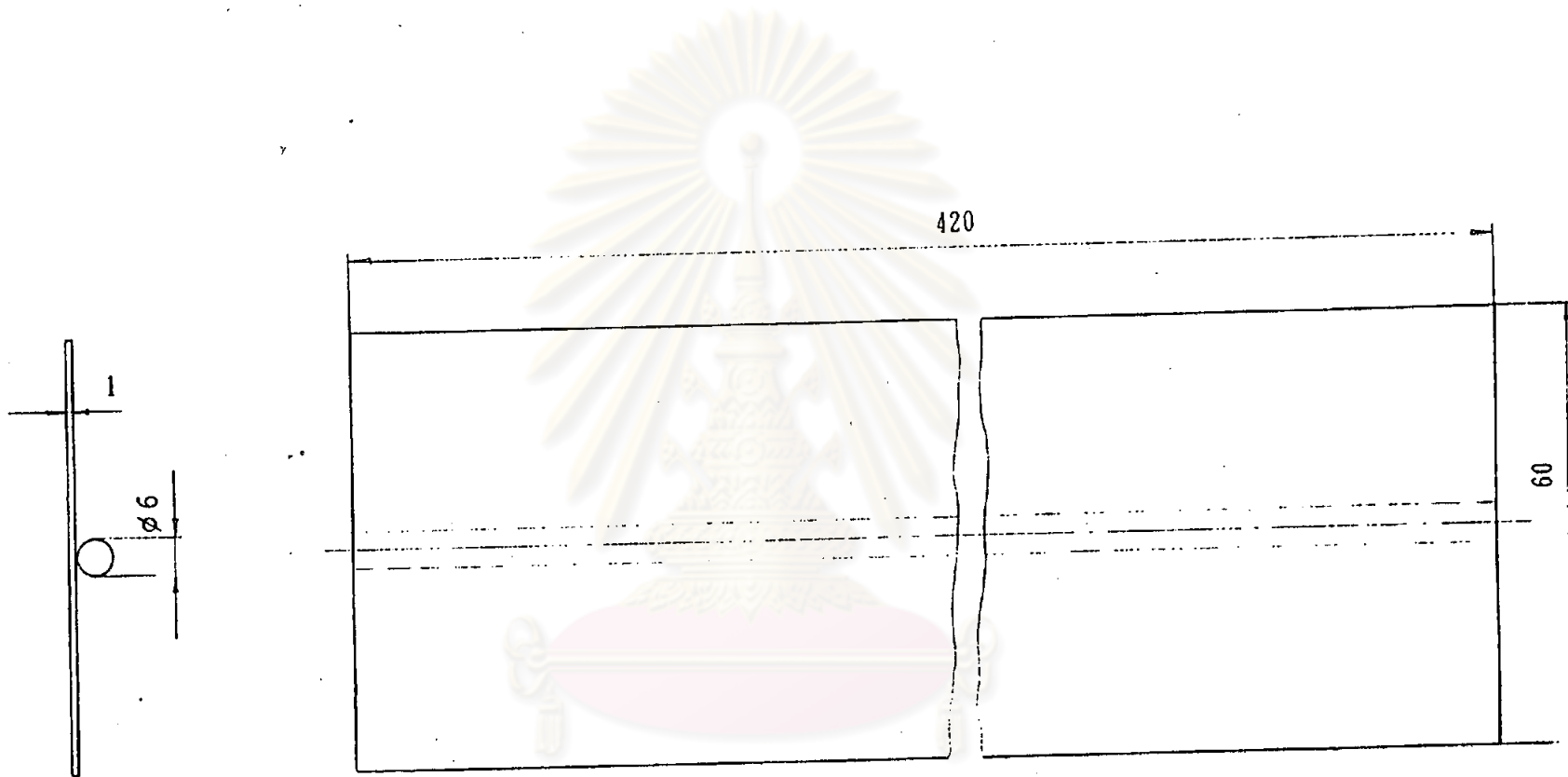

Fig.4.15 Dimensions of testing model (NACA 4418)

ศูนย์วิทยทรัพยากร
จุฬาลงกรณ์มหาวิทยาลัย



ศูนย์วิทยทรัพยากร

Fig. 4.16 Dimensions of testing model (straight plate)



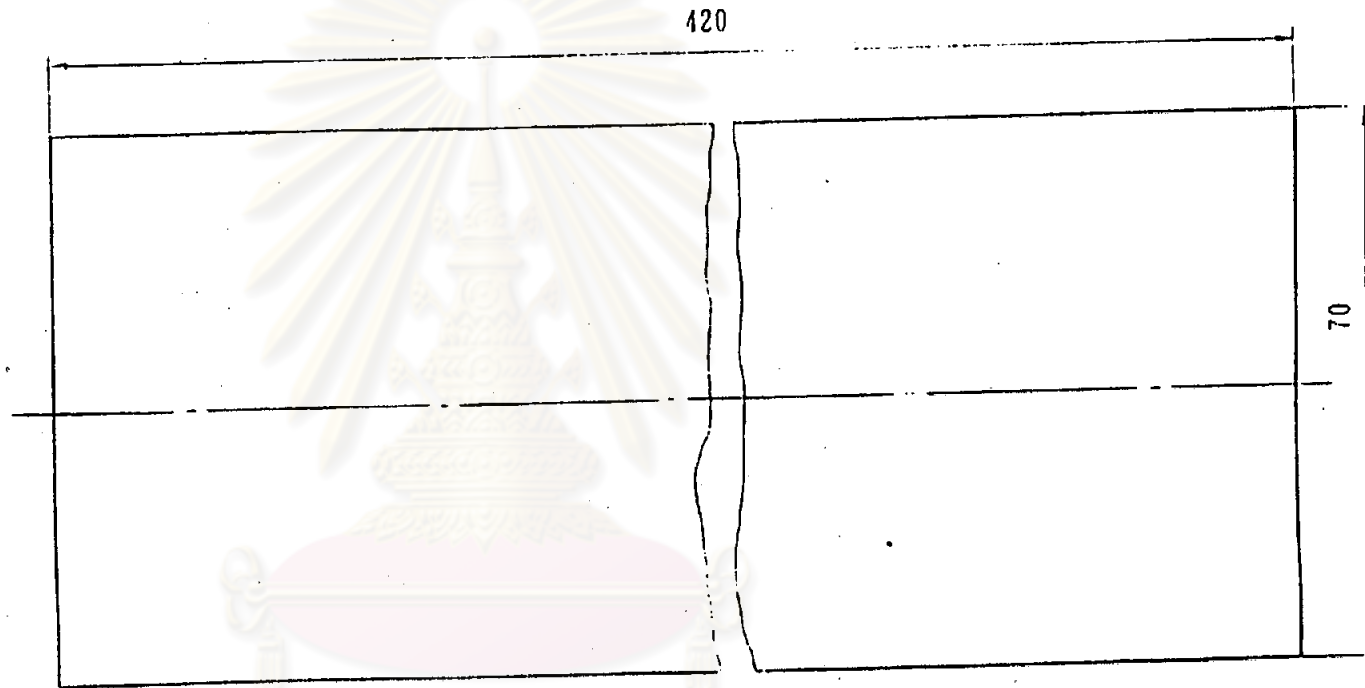
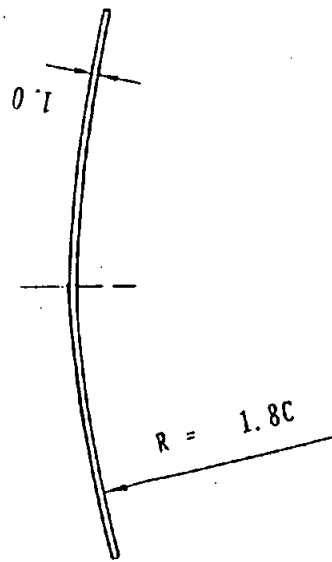

Fig.4.17 Dimensions of testing model Arched plate No.1

ศูนย์วิทยพัชกร
จุฬาลงกรณ์มหาวิทยาลัย

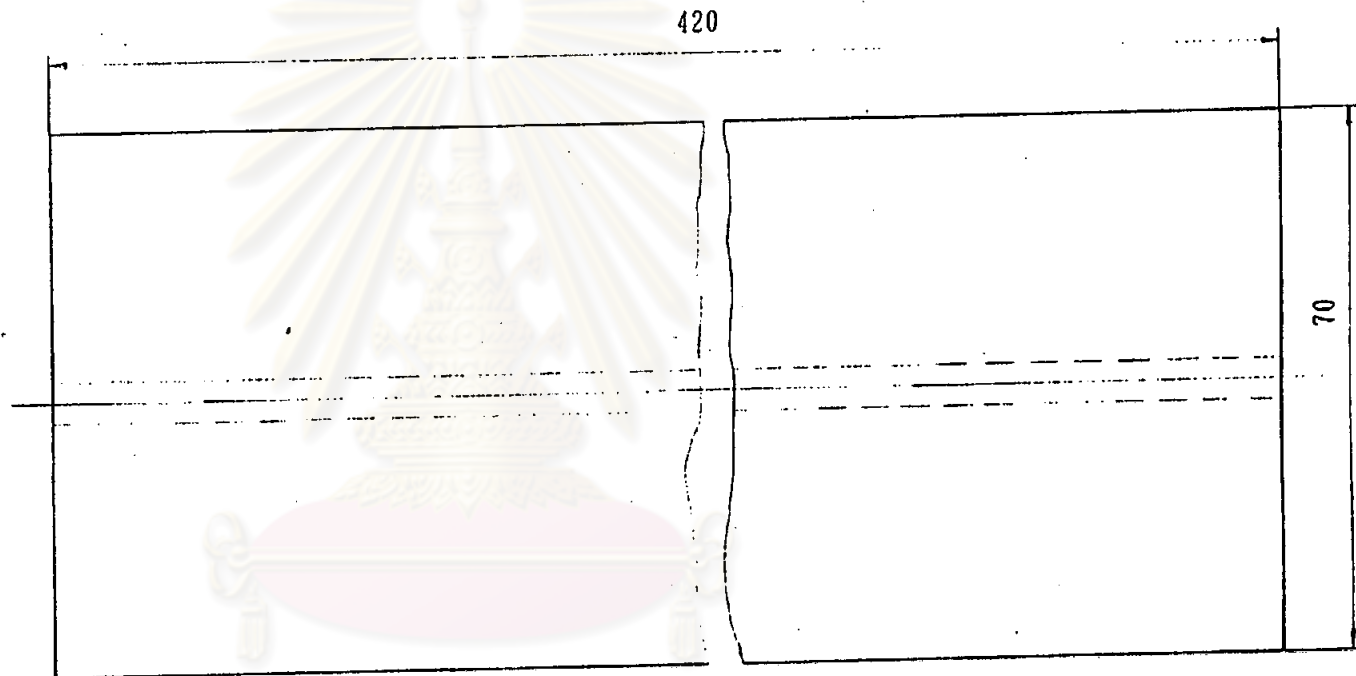
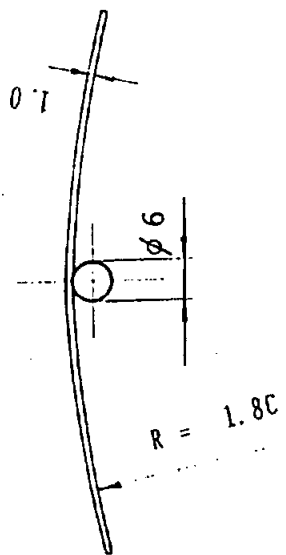

Fig.4.18 Dimensions of testing model Arched plate No.2

ศูนย์วิทยทรัพยากร
จุฬาลงกรณ์มหาวิทยาลัย

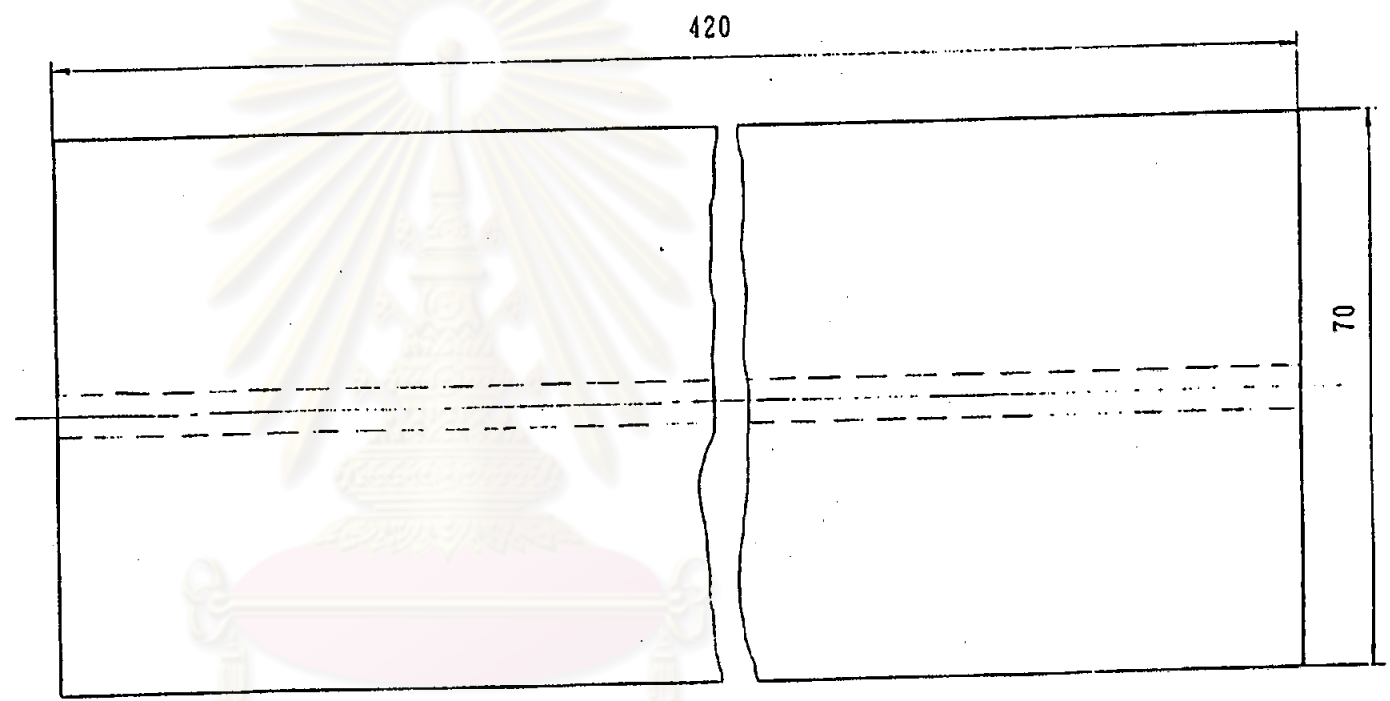
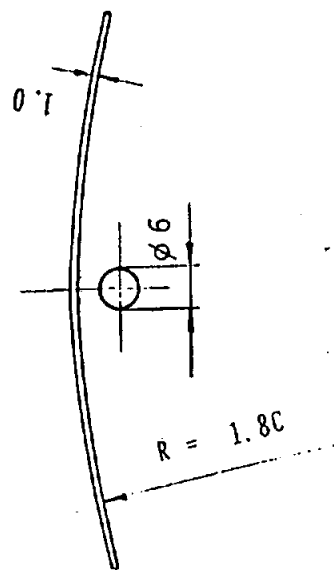
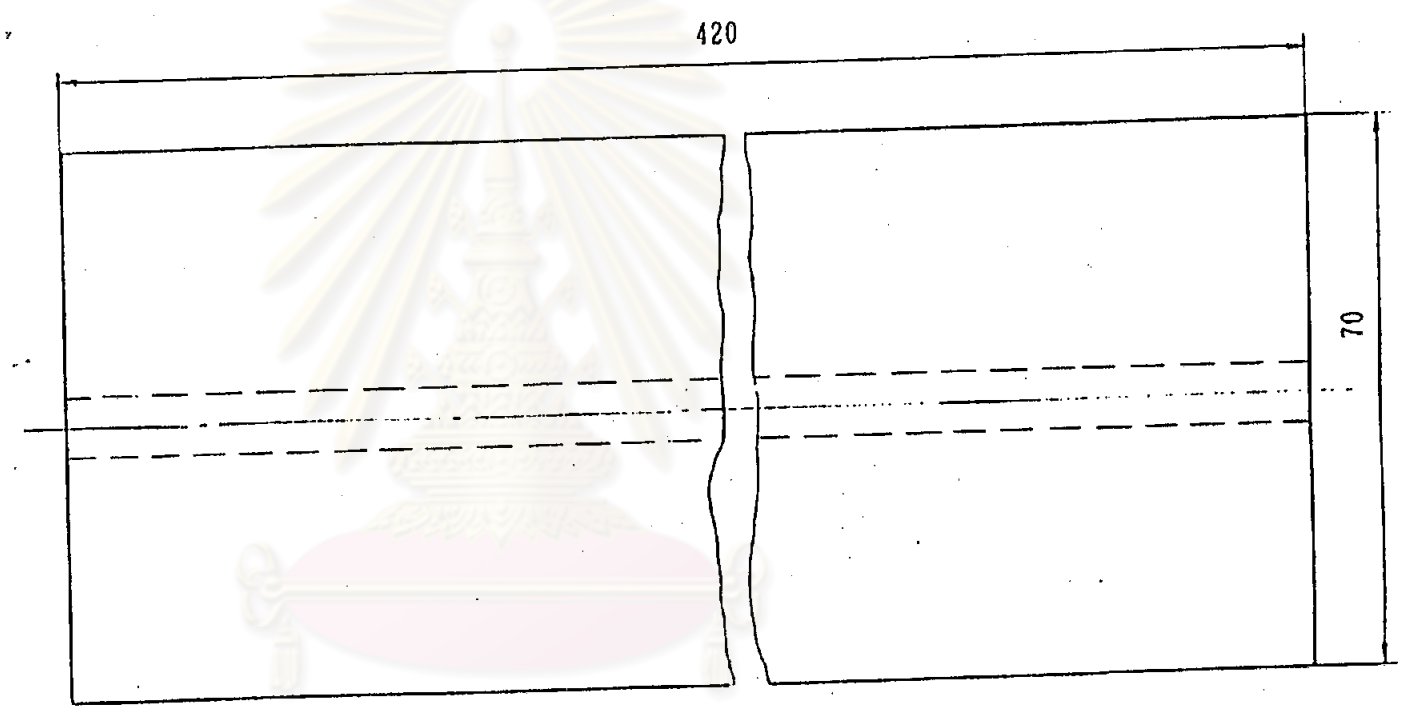
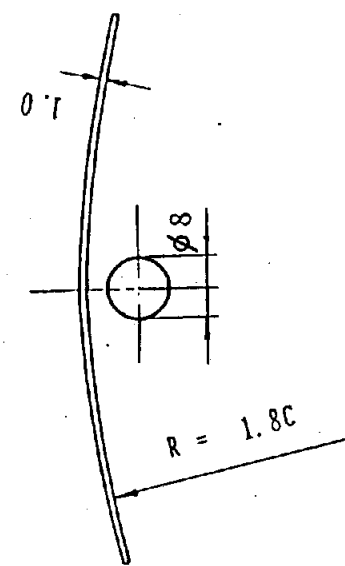

Fig.4.19 Dimensions of testing model Arched plate No.3

ศูนย์วิทยทรัพยากร
จุฬาลงกรณ์มหาวิทยาลัย

18004672



ศูนย์วิทยทรัพยากร
จุฬาลงกรณ์มหาวิทยาลัย
Fig.4.20 Dimensions of testing model Arched plate No.4



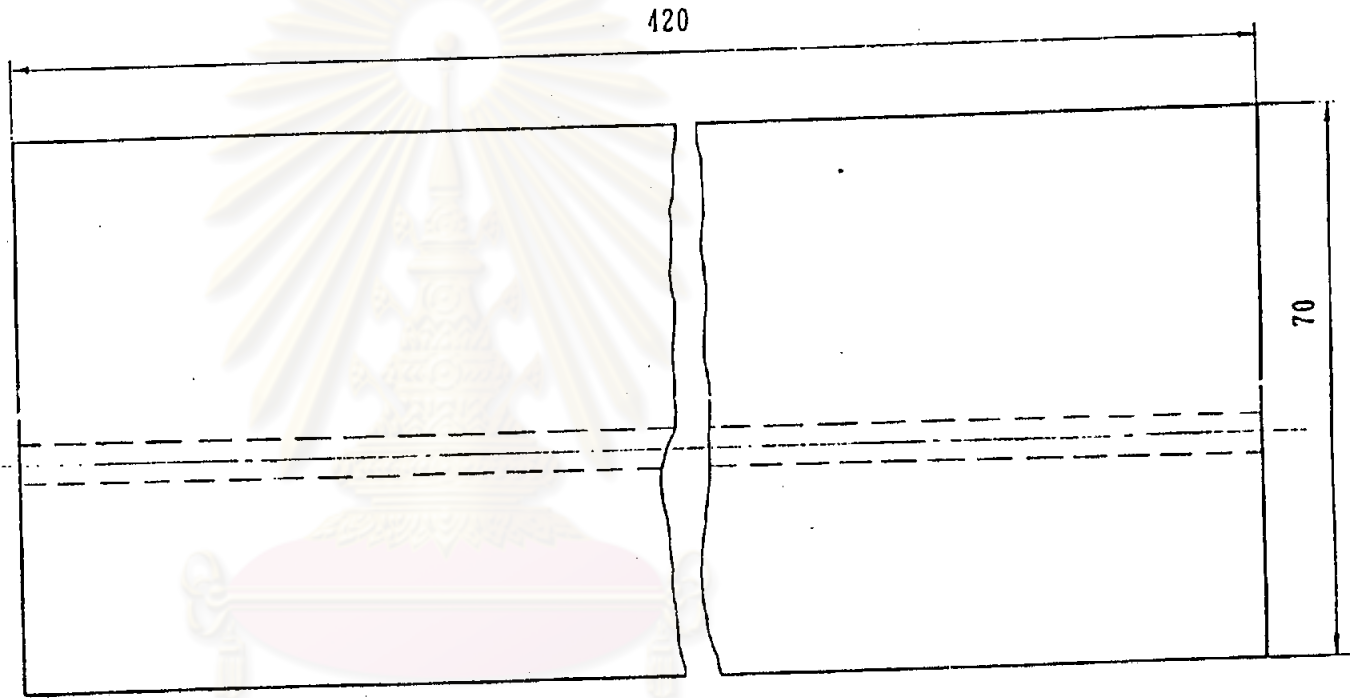
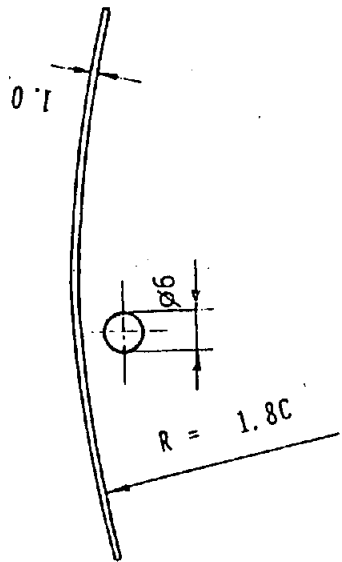

Fig. 4.21 Dimensions of testing model Arched plate No.5

ศูนย์วิทยทรัพยากร
จุฬาลงกรณ์มหาวิทยาลัย

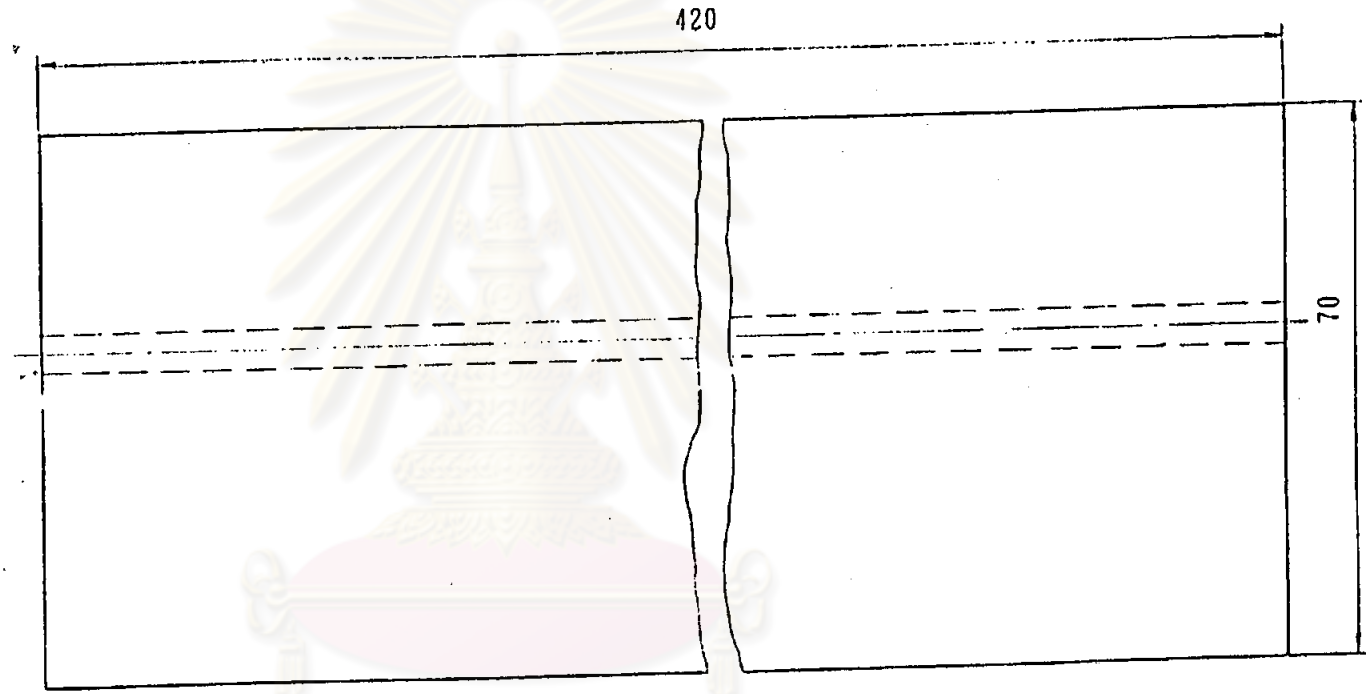
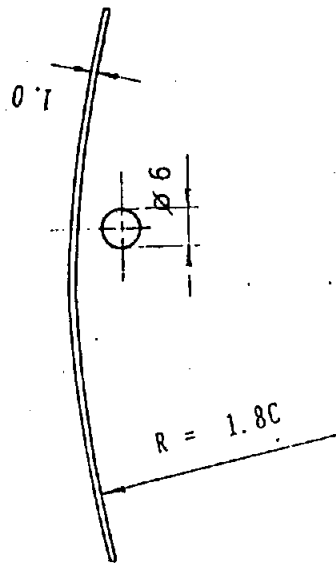

Fig.4.22 Dimensions of testing model Arched plate No.6

ศูนย์วิทยุทรัพยากร
จุฬาลงกรณ์มหาวิทยาลัย

4.3 Flow Visualization

This experiment was divided into 2 parts as follows:

4.3.1 At high Reynolds numbers

The smoke wind tunnel as shown in Figs.4.49 to 4.53, which has 500x70x900 mm in test section is used during the experiment. The models for testing have 150 and 200 mm in chord length and 70 mm in span width as shown in Figs.4.54 to 4.58. The smoke is generated by burning of light oil at smoke generator.

The experiment was performed at Reynolds number between 46,000 and 64,000. This experimental purpose was to see the flow of air when it passed through the airfoil and the effect on the value of lift and drag.

The angle of attack was varied from -15 to 40 degrees.

ศูนย์วิทยทรัพยากร
จุฬาลงกรณ์มหาวิทยาลัย

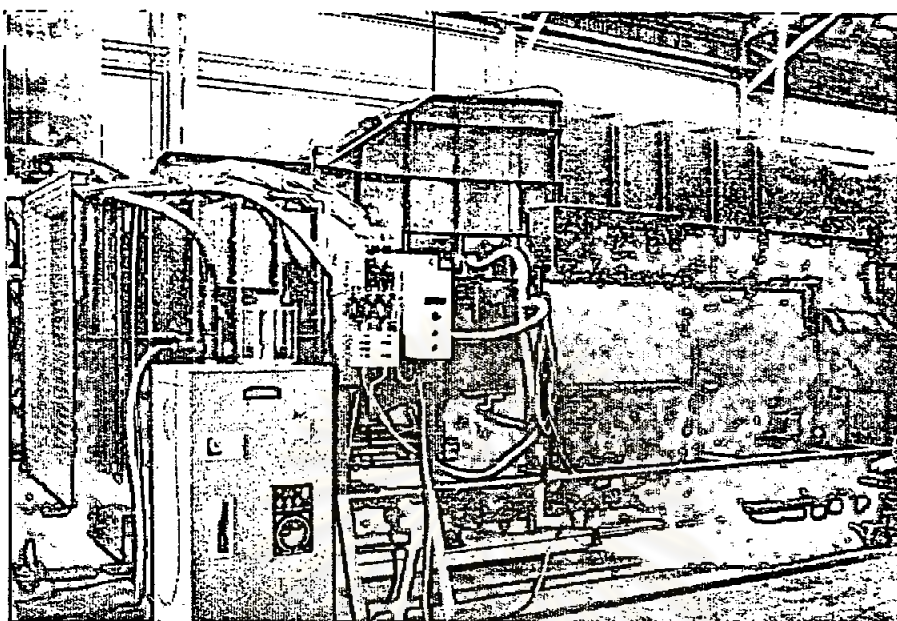

Fig. 4.49 Smoke-wind tunnel

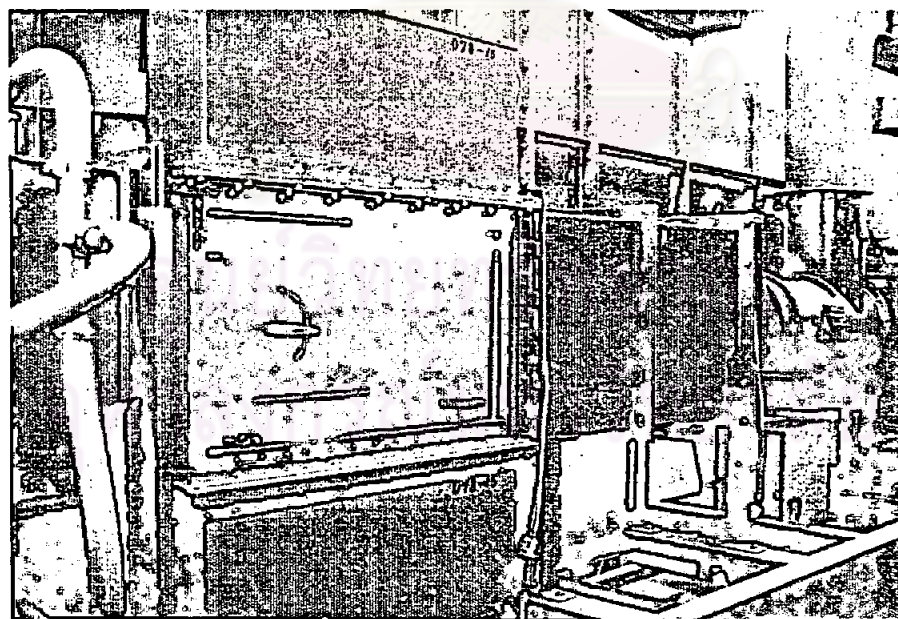

Fig. 4.50 Test section of smoke-wind tunnel

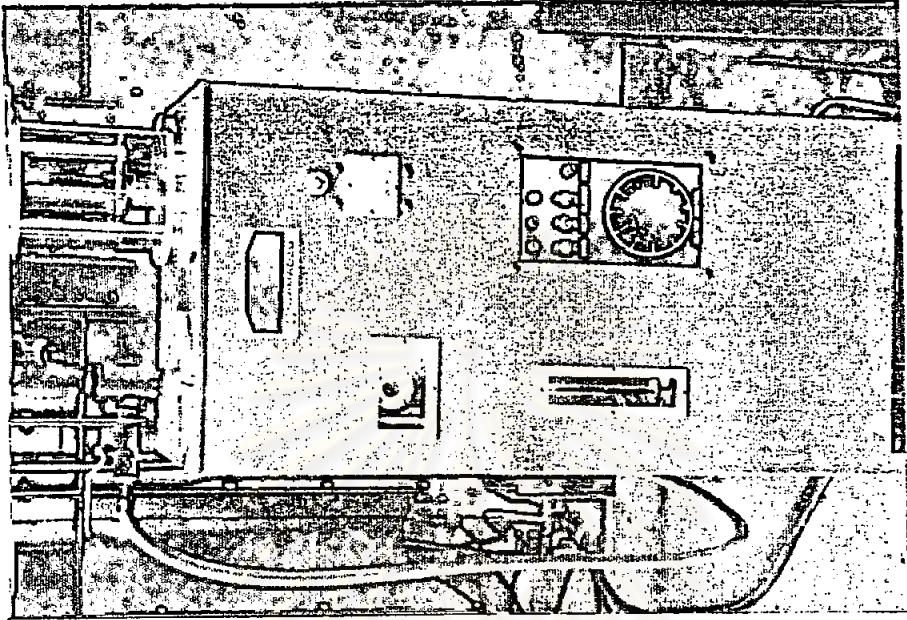

Fig. 4.52 Smoke generator device

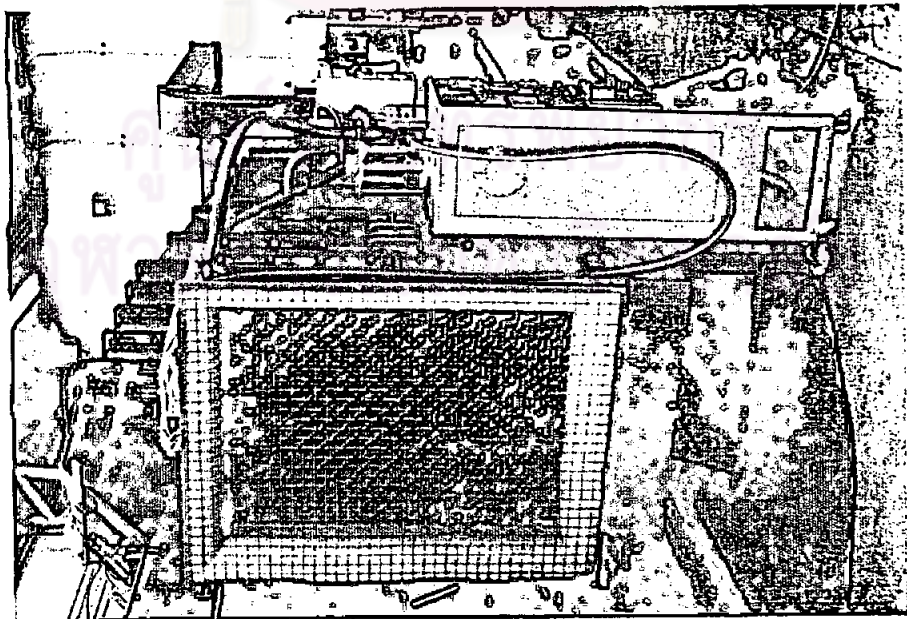

Fig. 4.51 Air inlet side of smoke-wind tunnel

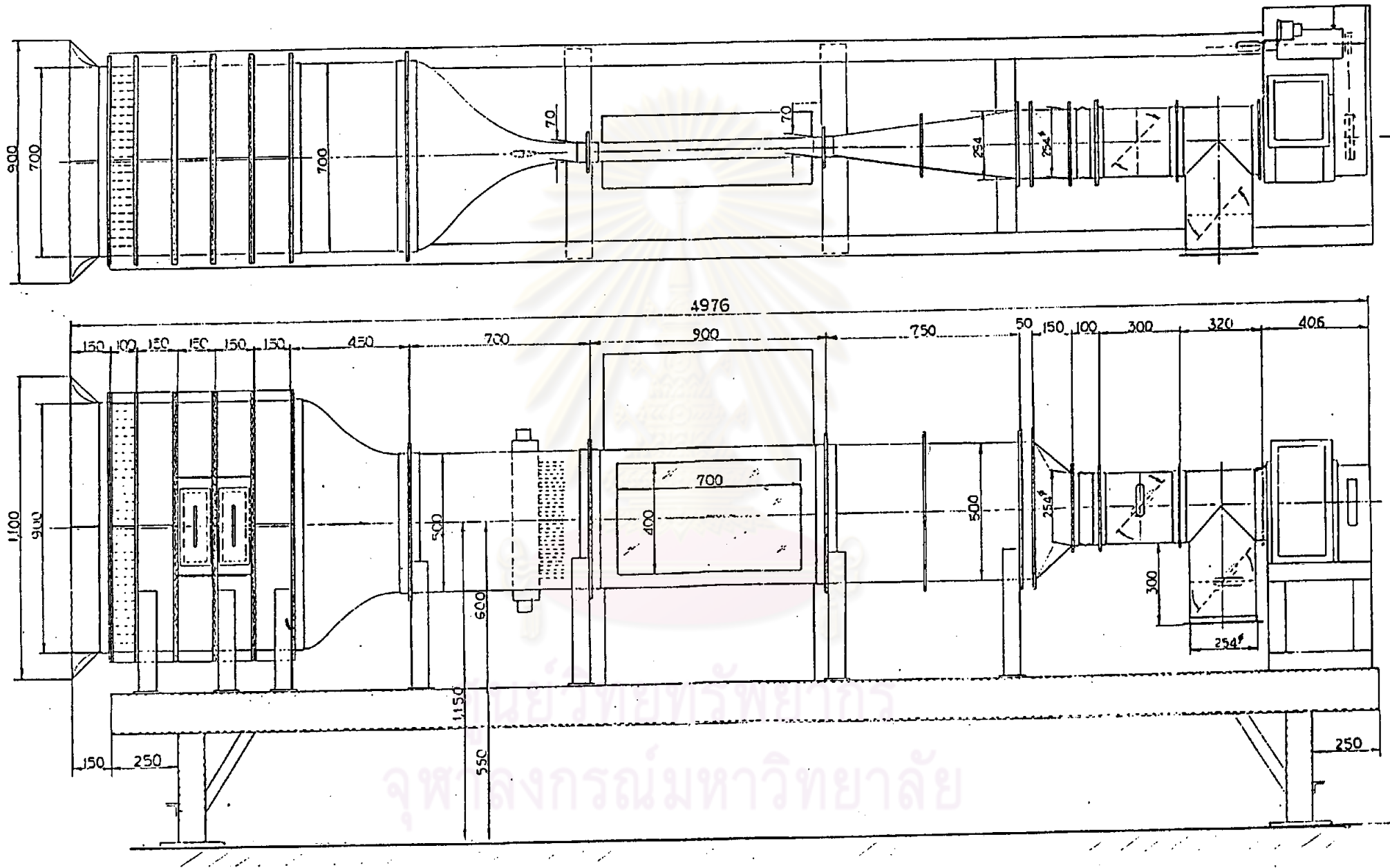

Fig. 4.53 Dimensions of smoke-wind tunnel

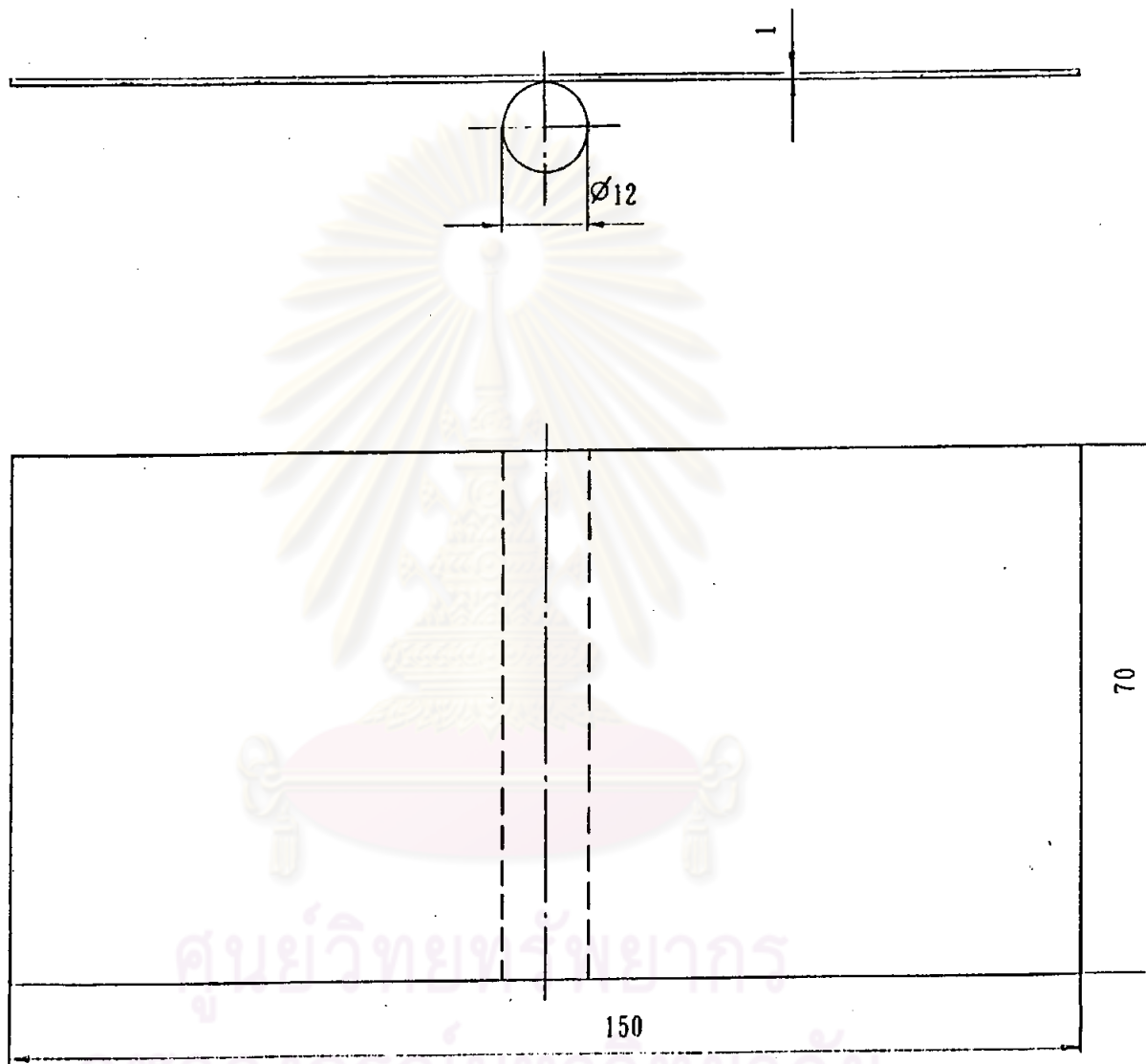

Fig.4.54 Flow visualization model (straight plate)

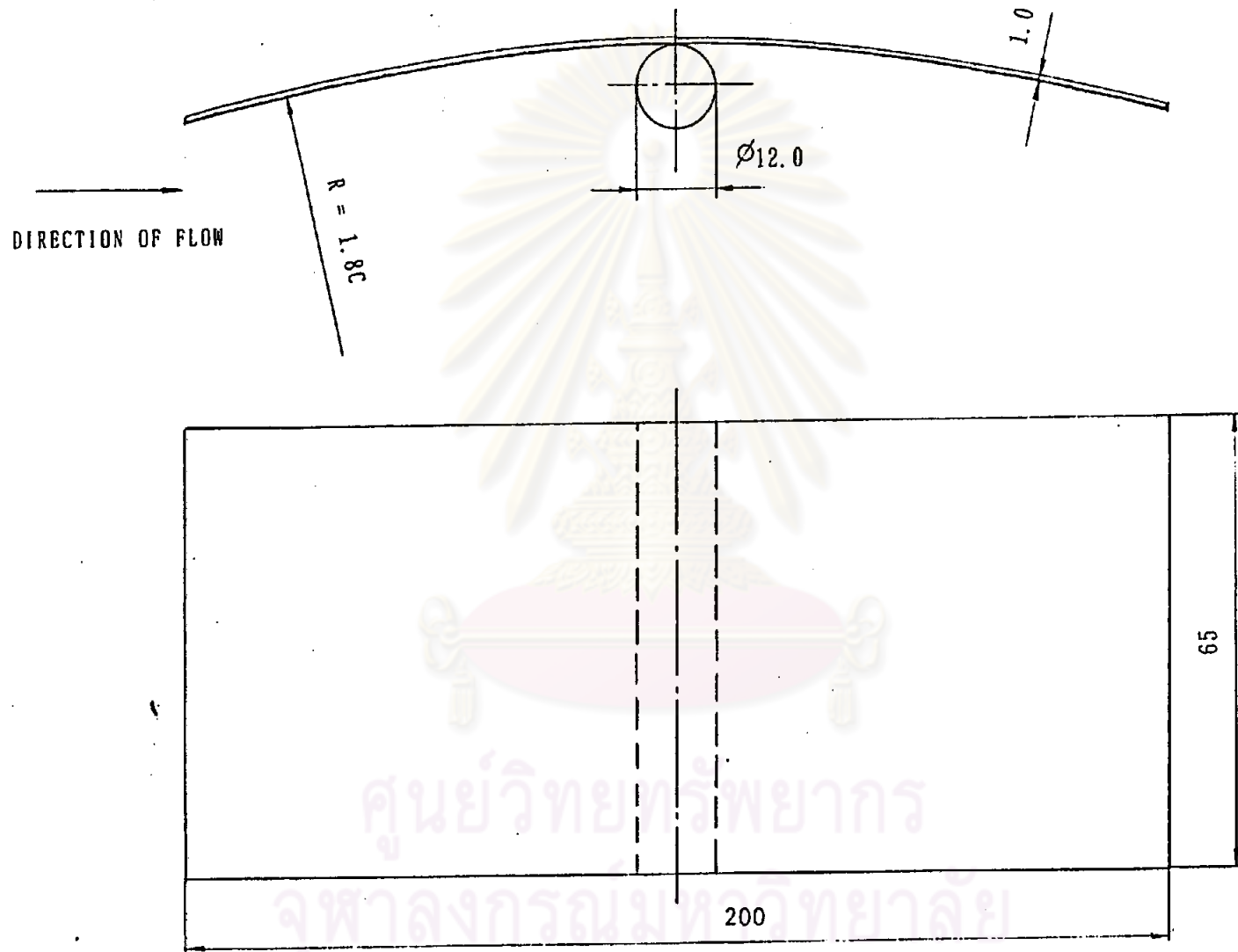

Fig. 4.55 Flow visualization model (Arched plate No.2)

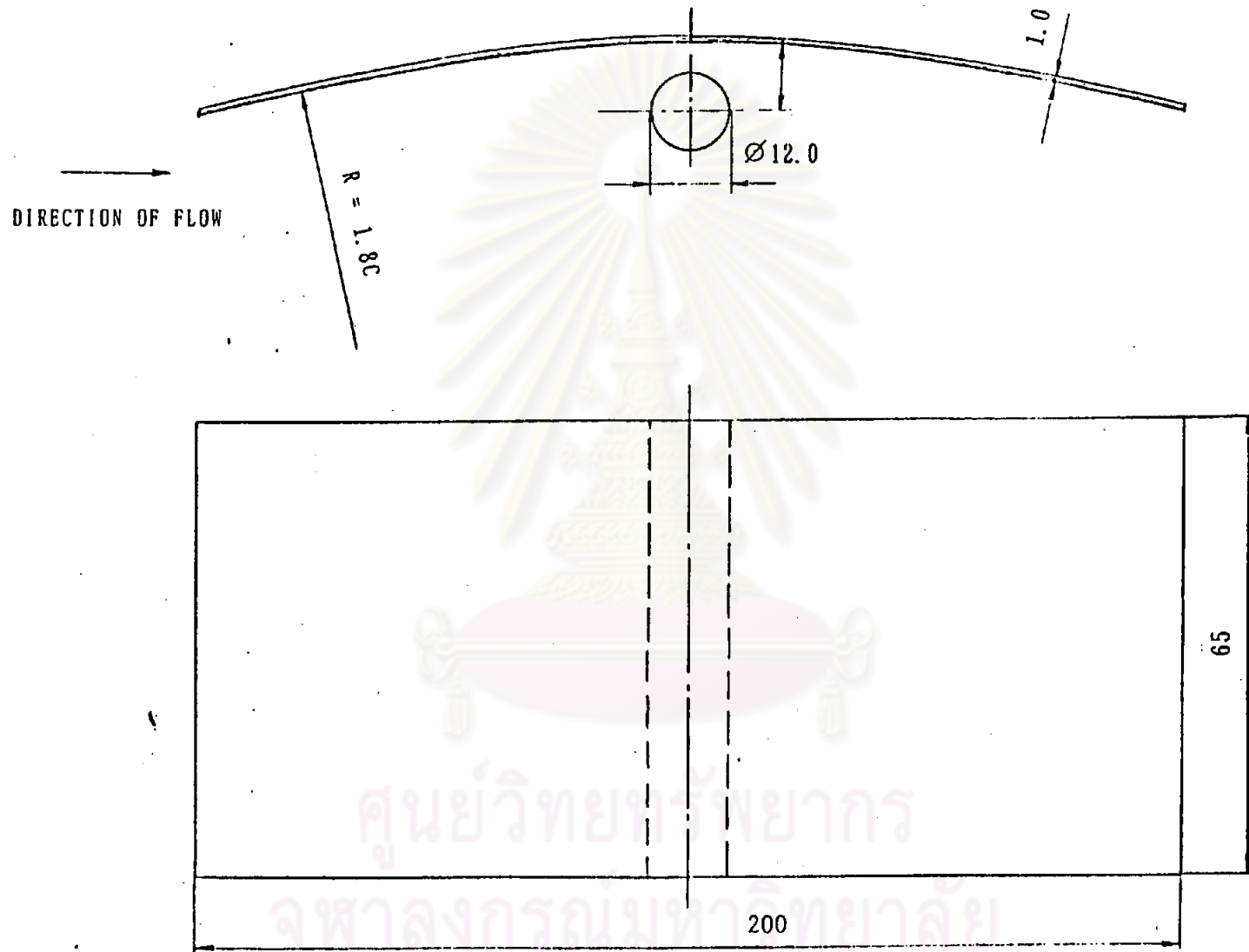

Fig. 4. 56 Flow visualization model (Arched plate No. 3)

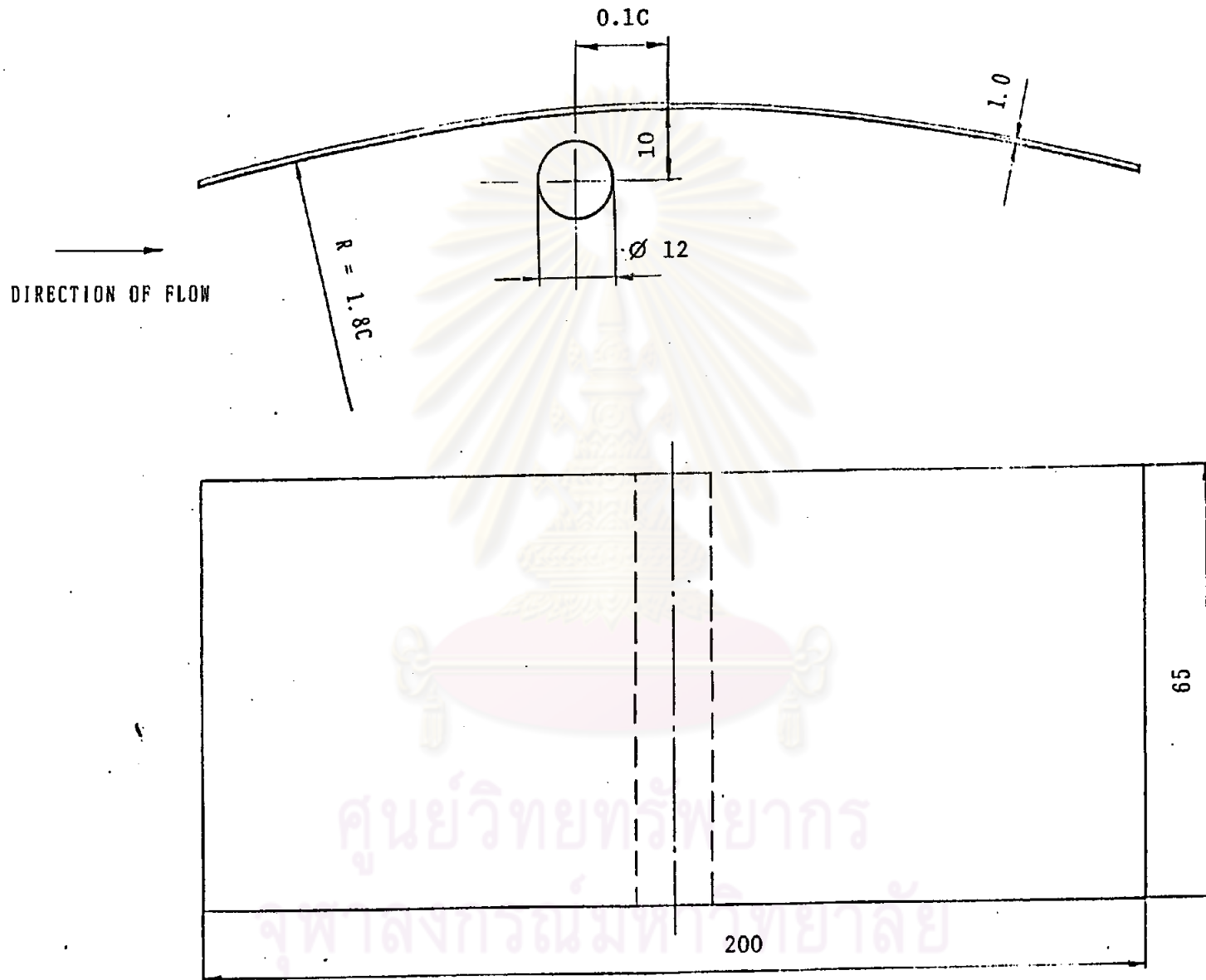

Fig. 4.57 Flow visualization model (Arched plate No.5)

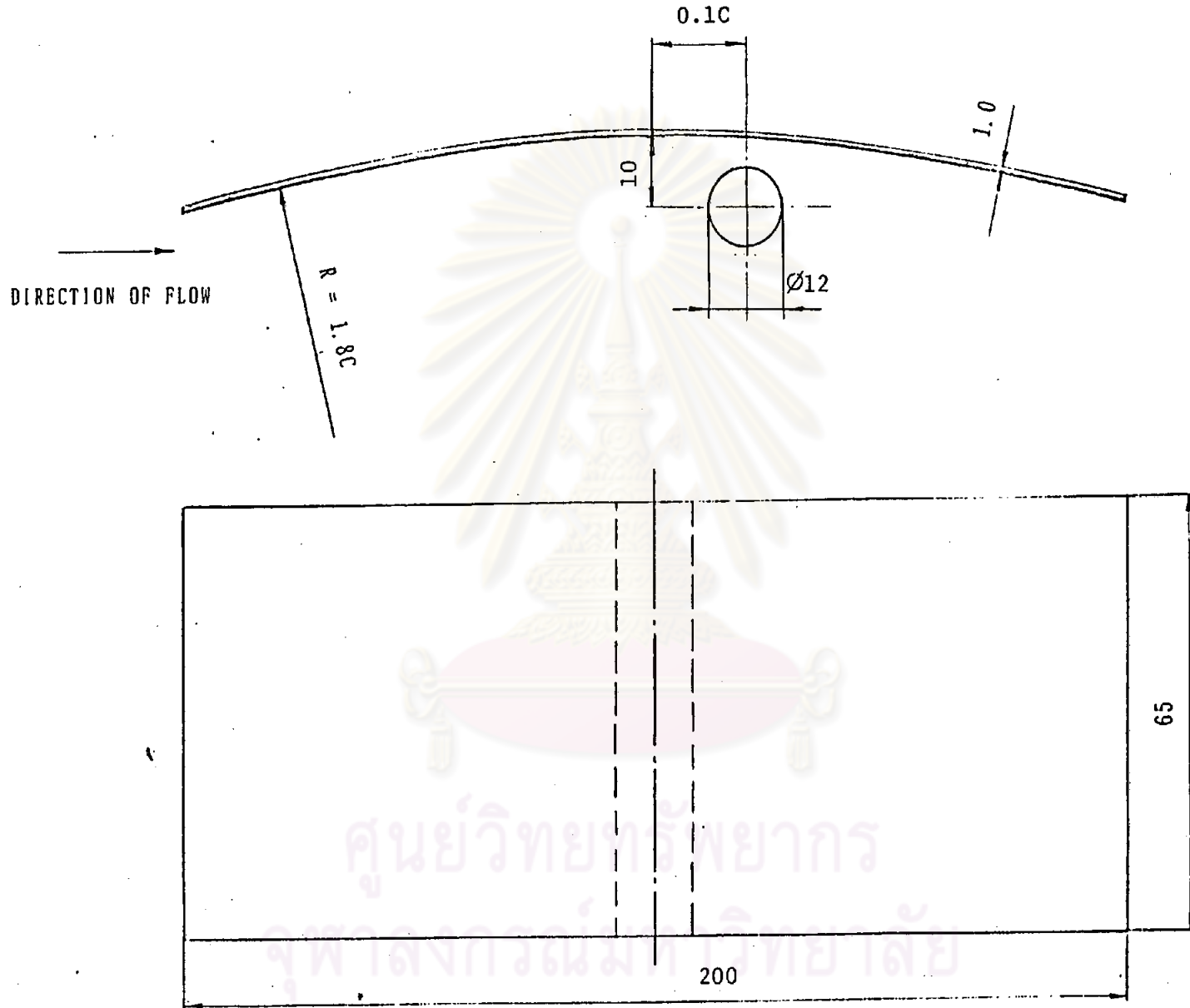

Fig. 4. 58 Flow visualization model (Arched plate No. 6)

4.3.2 At Low Reynolds Numbers

By using water channel as shown in Figs.4.117 and 4.118, where aluminum powder was distributed over water surface, the velocity of flow water was controlled by the speed of the motor which connected with the turbine shaft.

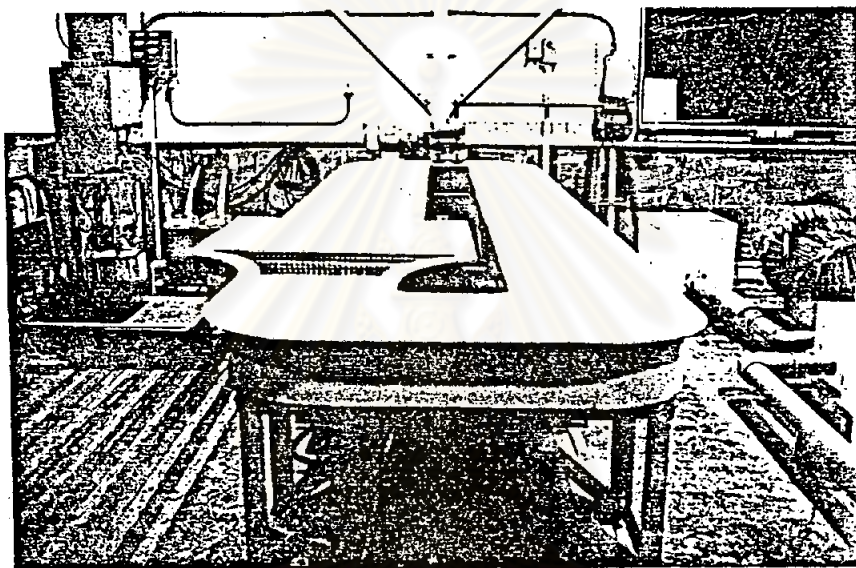

Fig.4.117 Water channel

The Reynolds numbers of the experiment were about 7,000 to 15,000. The models were 60 and 150 mm in chord length. The purpose of this experiment was to see the flow around the model at low Reynolds numbers. Figures 4.119 and 4.120 show some results of this experiment.

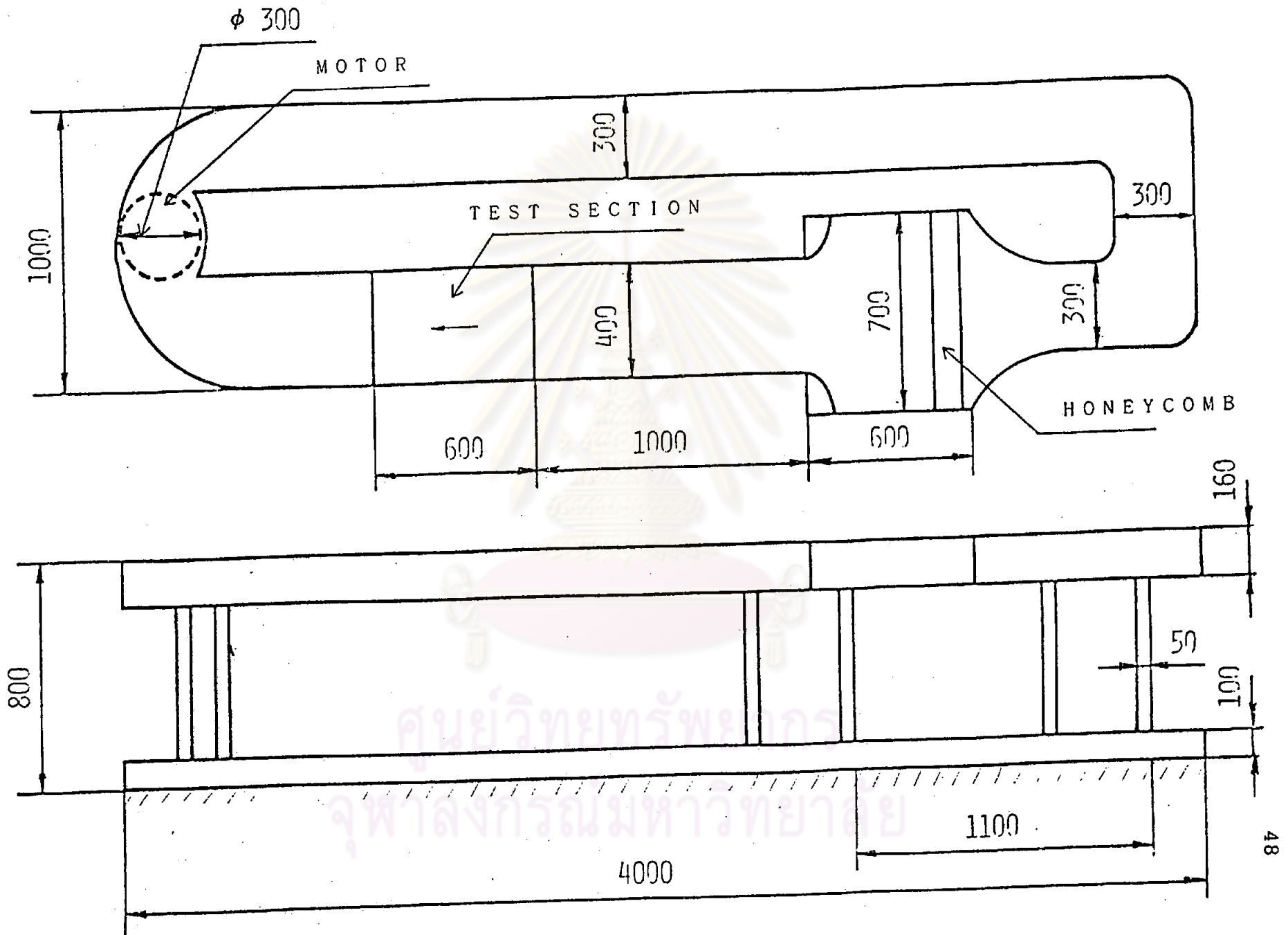

Fig. 4.118 Dimensions of water channel



Fig. 4.119 Flow visualization of arched plate airfoil with a stick contacted with plate ($Re = 10600$, $\alpha = 15$ degrees)

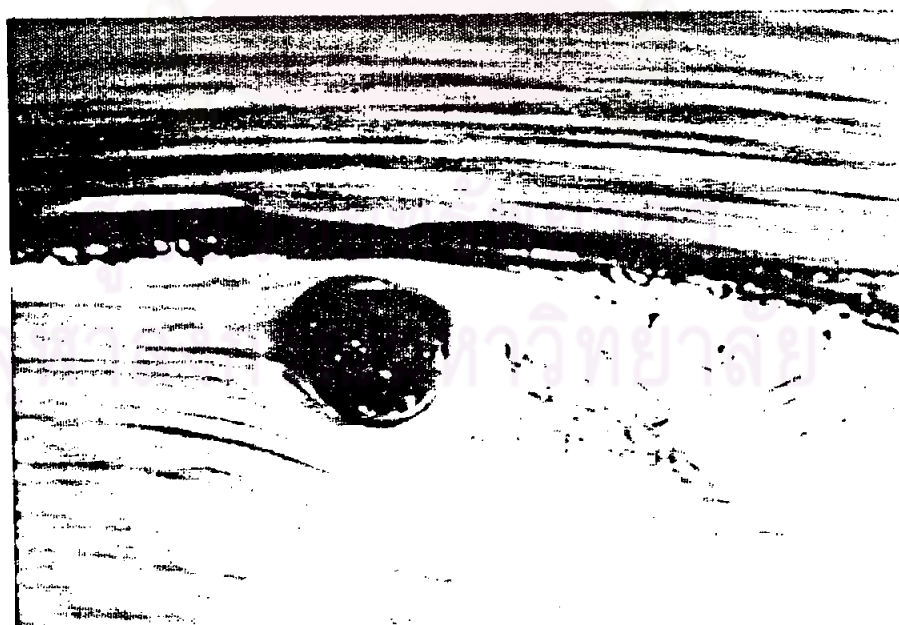

Fig. 4.120 Flow visualization of arched plate airfoil with a stick not contacted with plate ($Re = 15000$, $\alpha = 10$ degrees)

4.4 Discussion of Experiment

1. In each type of airfoil at different Reynolds number, the value of CL and CD of airfoil changed little when the value of Reynolds number was changed. The value of CL/CD at each Reynolds number with attack angle around the maximum value of CL/CD, the difference could be seen obviously while others were not.

2. For different types of airfoil at nearly equal in Reynolds number, the experimental results show that arched steel plate types had good aerodynamic characteristics in comparison with other types of airfoils.

3. The maximum value of CL of arched plate with the stick 6 mm in diameter (not contact with plate) at the center was about 0.8, maximum ratio of CL/CD was about 20-30 for Reynolds number about 60,000-80,000 at attack angles of 4-6 degrees.

4. From the experimental results arched plate airfoils with the same diameter of the stick (6 mm), the arched plate airfoil with the stick not in contact with the plate had better aerodynamic characteristics than that with the stick in contact with plate due to the difference in size of the vortex that occurred behind the stick.

5. Arched plate airfoils in which the stick was moved to the leading edge (0.1c) had better aerodynamic characteristics than arched airfoils whose sticks were moved to the trailing edge.

6. For arched plate airfoils, the position of

the stick along chord length effected the value of CL and CD.

7. From flow visualization experiment at low Reynolds number, the vortex that occurred behind the stick of the airfoil could be seen obviously.

8. The difference in flow pattern around the arched plate between airfoils with the stick contact and not contact with the plate also understood.



ศูนย์วิทยทรัพยากร
จุฬาลงกรณ์มหาวิทยาลัย