

CHAPTER V  
DISCUSSION AND CONCLUSION



5.1 Wave-Induced Mass Transport Velocity

In the first and eighth experiments, no Coriolis effect is involved because the wave tank was not rotated. Experimental results (see Tables 3.1, 3.8 and Figs. 11.1, 11.8) clearly show that there are wave-induced mass transportation. However the experimental values are much higher than the theoretical ones (see Tables 4.1 - 4.9).

Although experimental results are rather scattered, they indicated that immediately under the water surface mass transport velocity decreases drastically as predicted by the second order wave theory. (The theory predicts that the velocity decreases exponentially as the depth increases.)

The above discussion is also true for all the other experiments. It is so because Coriolis effect does not have direct influence on velocity in x-direction.

## 5.2 Velocity Related to Coriolis Effect

The experimental results show that the currents in general are in direction as predicted by the orbital flow theory, i.e. being deviated to the right when the tank rotated counterclockwise and to the left when the tank rotated clockwise. However, the observed current velocity distributions in the vertical direction disagree with the orbital flow theory.

According to the orbital flow theory, the current velocity  $u$ , as given by Eq. (3.19), is linearly proportional to the distance from the bottom. The depth of water in the experimental tank was 38 cm. So the theoretical velocity ( $u$ ) at 3 cm from the surface, according to Eq. (3.19), is equal to  $(38-3)/38 = 0.92$  times the velocity  $u$  at surface. However, the results show all velocities  $u$  at 3 cm from the surface to be much smaller than the theoretical prediction. This seems to totally discredit the orbital flow theory. However, after restudying the orbital flow theory, it was founded that this fact only discredits the assumption that the Coriolis moment and Coriolis force are related to the current through the modified Newton's law of viscosity .



### 5.3 Conclusions

With respect to the orbital flow theory, the following conclusions could be drawn from the experiments.

1. The experimental results support the idea that oceanic surface current is related to waves. This idea is the basic assumption of the orbital flow theory.

2. The experimental results indicate that the orbital flow theory should be revised by changing the part concerning relationship between Coriolis moment, Coriolis force and the resulting current.

3. A new experimentation similar to this one should be carried out to study the wave phenomena in a rotating frame of reference. The following improvements in experimental techniques are suggested:

(1) The wave tank should be mounted on a more massive rotating platform so that the angular speed will be more steady.

(2) Fluid of more viscosity than water should be used.

(3) Instead of using drifters of cylindrical shape, spherical ones should be used. The size of the drifters should also be reduced so that they will be small relative to the sizes of wavelengths.

It is expected that with such improvement the observed experimental velocities will be less scattered.

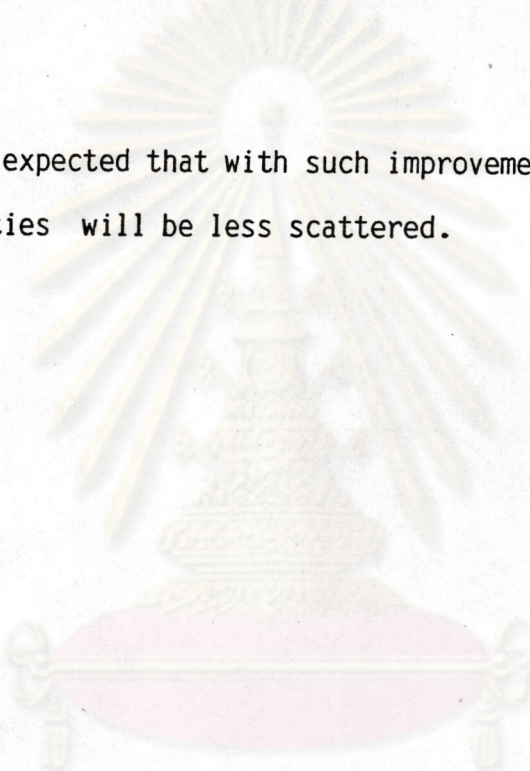

ศูนย์วิทยทรัพยากร  
จุฬาลงกรณ์มหาวิทยาลัย



Table 1 Experimental Tank Angular Frequencies and Coriolis Parameters

Exp.#	Angular Frequency (radians/sec)	Coriolis Parameter (radians/sec)
1	0.00	0.00
2	-0.19	-0.38
3	+0.19	+0.38
4	-0.25	-0.50
5	+0.25	+0.50
6	-0.39	-0.77
7	+0.39	+0.77
8	0.00	0.00
9	-0.39	-0.77

NOTE: -/+ signs indicate counterclockwise/clockwise rotation

Table 2 Experimental Wave Parameters

Exp.#	Amplitude <sup>β</sup> (cm)	Length <sup>β</sup> (cm)	Frequency <sup>α</sup> (/sec)
1	0.45	12.52	2.27
2	0.50	12.70	2.24
3	0.44	10.97	2.13
4	0.35	8.07	2.06
5	0.27	8.65	1.96
6	0.25	7.81	1.99
7	0.42	7.33	1.76
8	0.32	9.22	2.25
9	0.39	8.65	1.82

NOTE: <sup>β</sup> measured from pictures.

<sup>α</sup> measured from video screen.



Table 3.1 Experimental Mean Velocities  
(Experiment 1)

Depth (cm)	v (y-component) (cm/sec)		u (x-component) (cm/sec)	
	Velocity	S.D.	Velocity	S.D.
0	6.93	0.76	1.16	2.22
3	1.63	0.59	-0.26	0.58
5	1.75	0.33	-0.02	0.50
7	1.22	0.10	-0.22	0.36
13	1.22	0.17	-0.83	0.61

ศูนย์วิทยทรัพยากร  
จุฬาลงกรณ์มหาวิทยาลัย



Table 3.2 Experimental Mean Velocities  
(Experiment 2)

Depth (cm)	v (y-component) (cm/sec)		u (x-component) (cm/sec)	
	Velocity	S.D.	Velocity	S.D.
	0	4.32	2.59	-1.69
3	0.73	0.62	0.17	0.48
5	0.93	0.43	0.09	0.51
7	0.99	0.15	-0.37	0.18
13	0.91	0.55	0.29	0.57

Table 3.3 Experimental Mean Velocities  
(Experiment 3)

Depth (cm)	v (y-component) (cm/sec)		u (x-component) (cm/sec)	
	Velocity	S.D.	Velocity	S.D.
	0	2.68	1.04	0.67
3	0.92	0.48	0.10	0.03
5	0.89	0.38	0.68	0.35
7	0.69	0.65	0.61	0.33
13	0.71	0.34	0.81	0.19



Table 3.4 Experimental Mean Velocities  
(Experiment 4)

Depth (cm)	v (y-component) (cm/sec)		u (x-component) (cm/sec)	
	Velocity	S.D.	Velocity	S.D.
	0	2.63	1.27	-1.23
3	1.18	0.25	-0.71	0.70
5	1.45	1.66	-0.59	0.36
7	0.76	1.06	-1.08	0.85
13	-0.02	0.49	-1.07	0.23

Table 3.5 Experimental Mean Velocities  
(Experiment 5)

Depth (cm)	v (y-component) (cm/sec)		u (x-component) (cm/sec)	
	Velocity	S.D.	Velocity	S.D.
	0	2.95	1.82	1.74
3	1.15	0.38	0.06	0.61
5	0.58	0.36	0.71	0.57
7	0.23	0.44	1.31	0.65
13	1.12	0.45	0.54	0.08



Table 3.6 Experimental Mean Velocities  
(Experiment 6)

Depth (cm)	v (y-component) (cm/sec)		u (x-component) (cm/sec)	
	Velocity	S.D.	Velocity	S.D.
	0	2.89	1.17	-2.43
3	-0.06	0.57	-1.26	0.28
5	1.17	-	-0.36	0.14
7	1.44	1.31	-1.01	0.59
13	0.63	1.09	1.07	0.22

Table 3.7 Experimental Mean Velocities  
(Experiment 7)

Depth (cm)	v (y-component) (cm/sec)		u (x-component) (cm/sec)	
	Velocity	S.D.	Velocity	S.D.
	0	3.44	0.47	2.46
3	1.39	0.28	0.32	0.04
5	1.04	0.42	0.40	0.25
7	1.56	0.40	0.95	0.54
13	1.36	1.28	0.44	9.19





Table 3.8 Experimental Mean Velocities  
(Experiment 8)

Depth (cm)	v (y-component) (cm/sec)		u (x-component) (cm/sec)	
	Velocity	S.D.	Velocity	S.D.
	0	6.43	0.94	-0.29
3	1.55	0.56	-0.49	0.07
5	2.22	0.55	-0.19	0.41
7	1.53	0.79	-0.33	0.32
13	1.48	0.53	-0.62	0.16

Table 3.9 Experimental Mean Velocities  
(Experiment 9)

Depth (cm)	v (y-component) (cm/sec)		u (x-component) (cm/sec)	
	Velocity	S.D.	Velocity	S.D.
	0	4.39	1.92	-2.59
3	1.78	0.21	0.35	0.19
5	1.39	0.70	-0.25	0.12
7	0.23	-	0.35	-
13	0.46	-	0.07	-



Table 4.1 Comparison of Experimental and Theoretical  
Relative Velocities (Experiment 1)

Depth (cm)	V/V <sub>0</sub> (y-component)		U/U <sub>0</sub> (x-component)	
	obs.	theor.	obs.	theor.
0	1.00	1.00	1.00	-
3	0.23	0.05	-0.23	-
5	0.25	0.01	-0.01	-
7	0.18	0.00	-0.19	-
13	0.18	0.00	-0.71	-

ศูนย์วิทยทรัพยากร  
จุฬาลงกรณ์มหาวิทยาลัย



Table 4.2 Comparison of Experimental and Theoretical Relative Velocities (Experiment 2)

Depth (cm)	V/V <sub>0</sub> (y-component)		U/U <sub>0</sub> (x-component)	
	obs.	theor.	obs.	theor.
0	1.00	1.00	1.00	1.00
3	0.17	0.05	-0.10	0.92
5	0.22	0.01	-0.06	0.87
7	0.23	0.00	0.22	0.82
13	0.21	0.00	-0.17	0.66

Table 4.3 Comparison of Experimental and Theoretical Relative Velocities (Experiment 3)

Depth (cm)	V/V <sub>0</sub> (y-component)		U/U <sub>0</sub> (x-component)	
	obs.	theor.	obs.	theor.
0	1.00	1.00	1.00	1.00
3	0.34	0.03	0.14	0.92
5	0.33	0.00	1.01	0.87
7	0.26	0.00	0.90	0.82
13	0.26	0.00	1.20	0.66



Table 4.4 Comparison of Experimental and Theoretical  
Relative Velocities (Experiment 4)

Depth (cm)	V/V <sub>0</sub> (y-component)		U/U <sub>0</sub> (x-component)	
	obs.	theor.	obs.	theor.
0	1.00	1.00	1.00	1.00
3	0.45	0.01	0.58	0.92
5	0.56	0.00	0.48	0.87
7	0.29	0.00	0.88	0.82
13	-0.01	0.00	0.87	0.66

Table 4.5 Comparison of Experimental and Theoretical  
Relative Velocities (Experiment 5)

Depth (cm)	V/V <sub>0</sub> (y-component)		U/U <sub>0</sub> (x-component)	
	obs.	theor.	obs.	theor.
0	1.00	1.00	1.00	1.00
3	0.39	0.01	0.03	0.92
5	0.20	0.00	0.41	0.87
7	0.08	0.00	0.75	0.82
13	0.38	0.00	0.31	0.66



Table 4.6 Comparison of Experimental and Theoretical Relative Velocities (Experiment 6)

Depth (cm)	V/V <sub>0</sub> (y-component)		U/U <sub>0</sub> (x-component)	
	obs.	theor.	obs.	theor.
0	1.00	1.00	1.00	1.00
3	-0.02	0.01	0.52	0.92
5	0.40	0.00	0.15	0.87
7	0.50	0.00	0.42	0.28
13	0.22	0.00	-0.44	0.66

Table 4.7 Comparison of Experimental and Theoretical Relative Velocities (Experiment 7)

Depth (cm)	V/V <sub>0</sub> (y-component)		U/U <sub>0</sub> (x-component)	
	obs.	theor.	obs.	theor.
0	1.00	1.00	1.00	1.00
3	0.40	0.01	0.13	0.92
5	0.30	0.00	0.16	0.87
7	0.46	0.00	0.39	0.82
13	0.40	0.00	0.18	0.66



Table 4.8 Comparison of Experimental and Theoretical Relative Velocities (Experiment 8)

Depth (cm)	V/Vo (y-component)		V/Vo (x-component)	
	obs.	theor.	obs.	theor.
0	1.00	1.00	1.00	-
3	0.24	0.02	1.66	-
5	0.35	0.00	0.67	-
7	0.24	0.00	1.11	-
13	0.23	0.00	2.10	-

Table 4.9 Comparison of Experimental and Theoretical Relative Velocities (Experiment 9)

Depth (cm)	V/Vo (y-component)		U/Uo (x-component)	
	obs.	theor.	obs.	theor.
0	1.00	1.00	1.00	1.00
3	0.40	0.01	-0.13	0.92
5	0.32	0.00	0.10	0.87
7	0.05	0.00	-0.14	0.82
13	0.10	0.00	-0.03	0.66



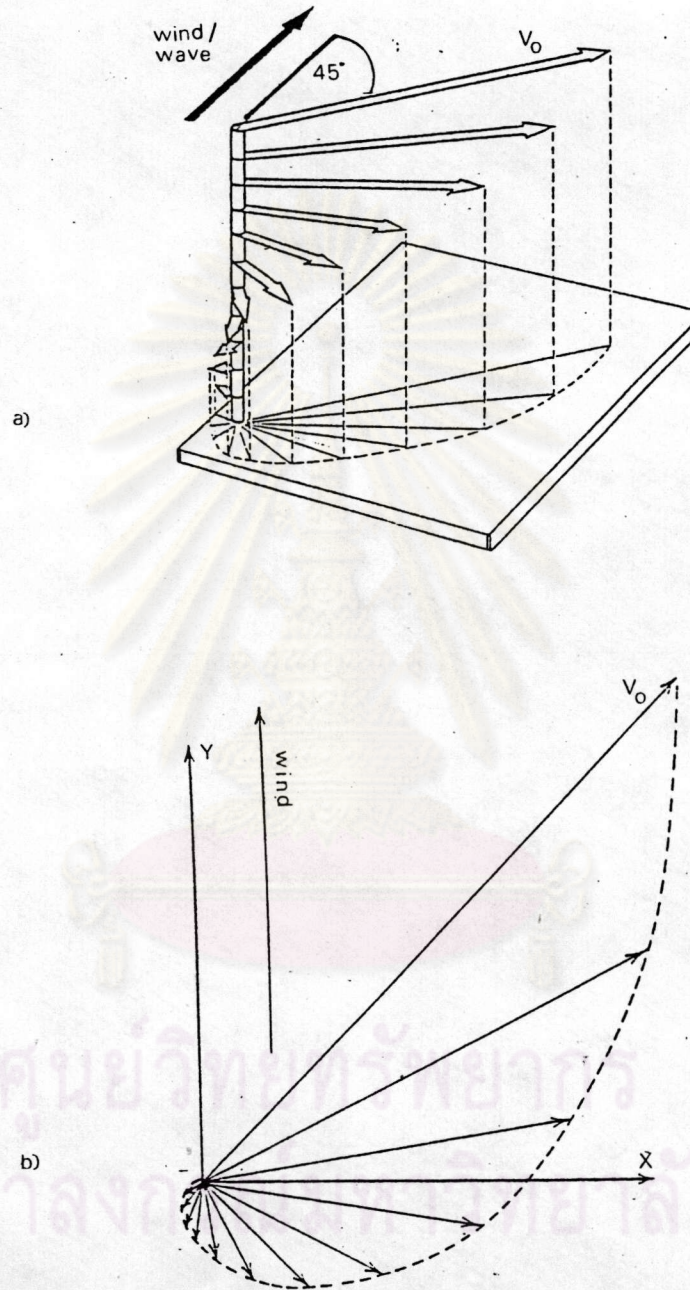

Figure 1 Ekman Spiral in an Infinitely Deep

a) Schematic diagram of Ekman spiral

b) Ekman spiral projected on a horizontal plane



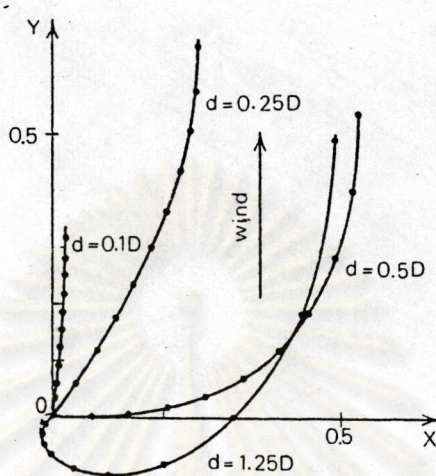

Figure 2 Ekman Spiral in Ocean of Finite Depths  
Projected on a horizontal plane.

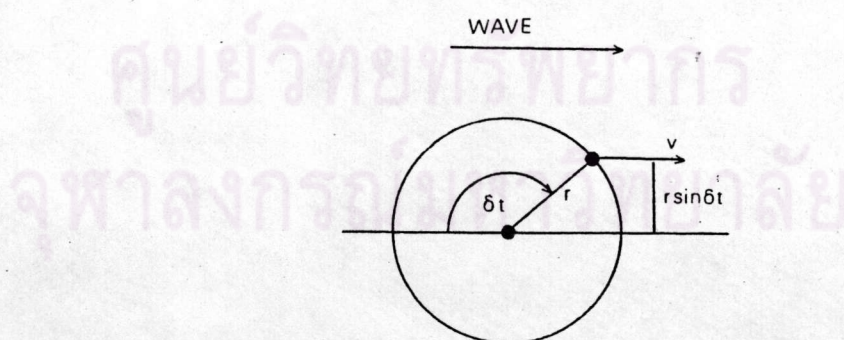

Figure 3 Definition of the Coriolis Moment



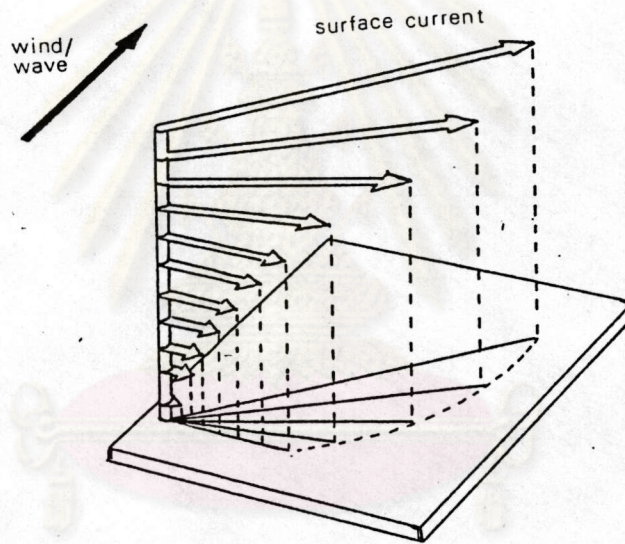

Figure 4 Velocity Distribution

According to the orbital flow theory

ศูนย์วิทยทรัพยากร  
จุฬาลงกรณ์มหาวิทยาลัย



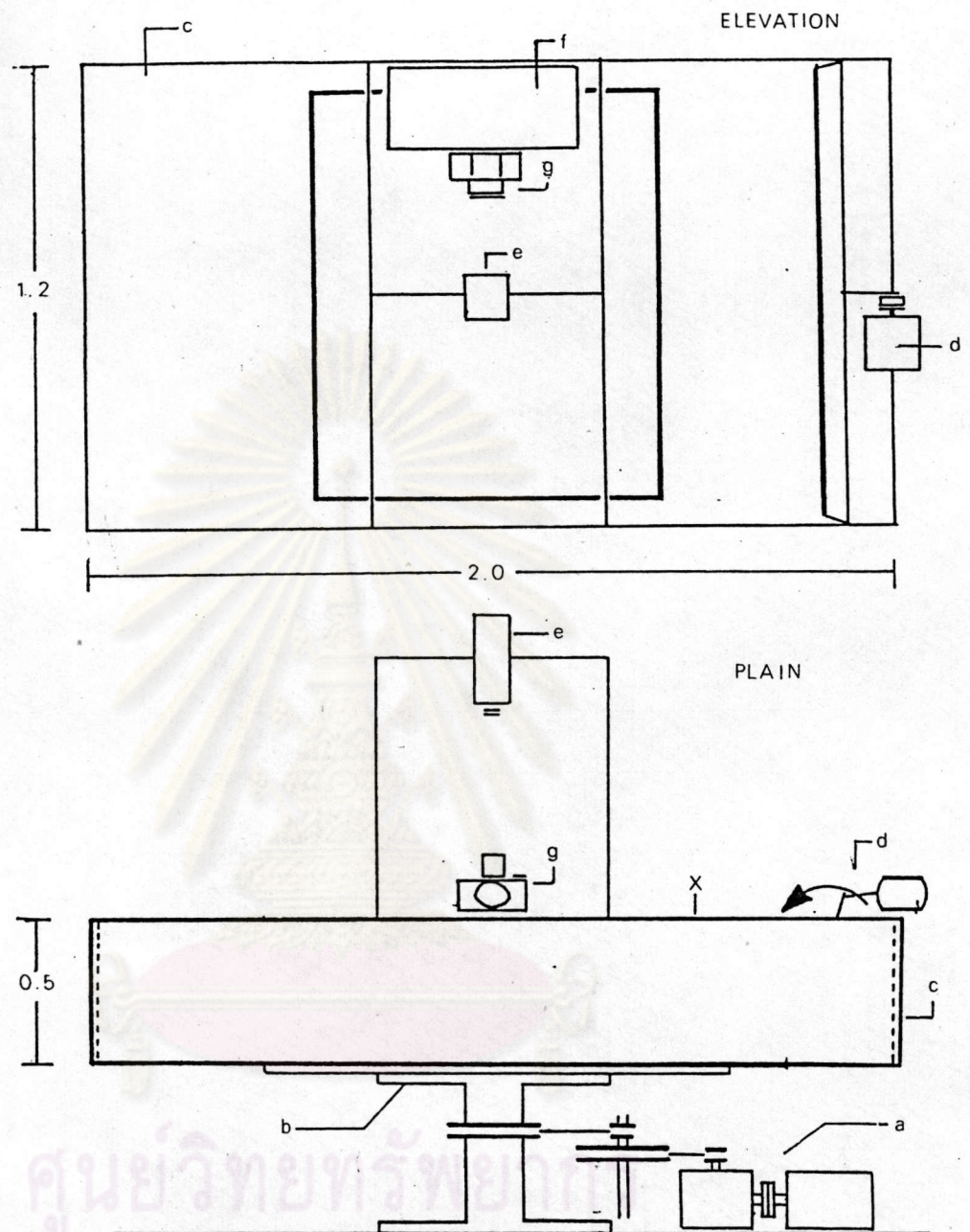

Figure 5 Experimental Configuration Drawing

Description:

- |                         |                       |
|-------------------------|-----------------------|
| (a) rotating machine    | (b) rotating platform |
| (c) wave tank           | (d) wave generator    |
| (e) video camera        | (f) video recorder    |
| (g) photographic camera |                       |



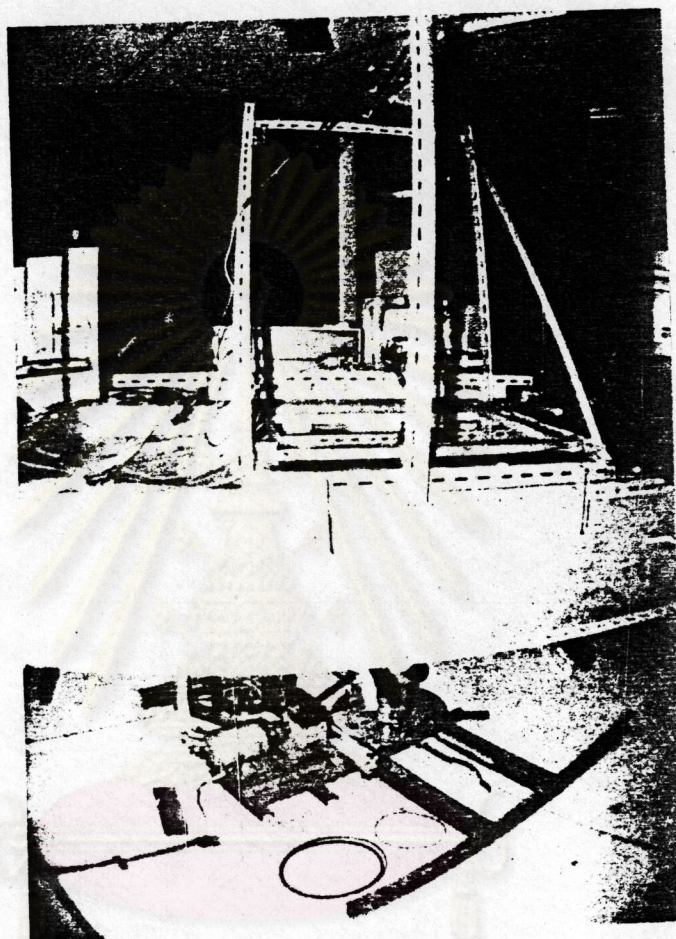

Figure 6 Experimental Configuration

ศูนย์วิทยทรัพยากร  
จุฬาลงกรณ์มหาวิทยาลัย



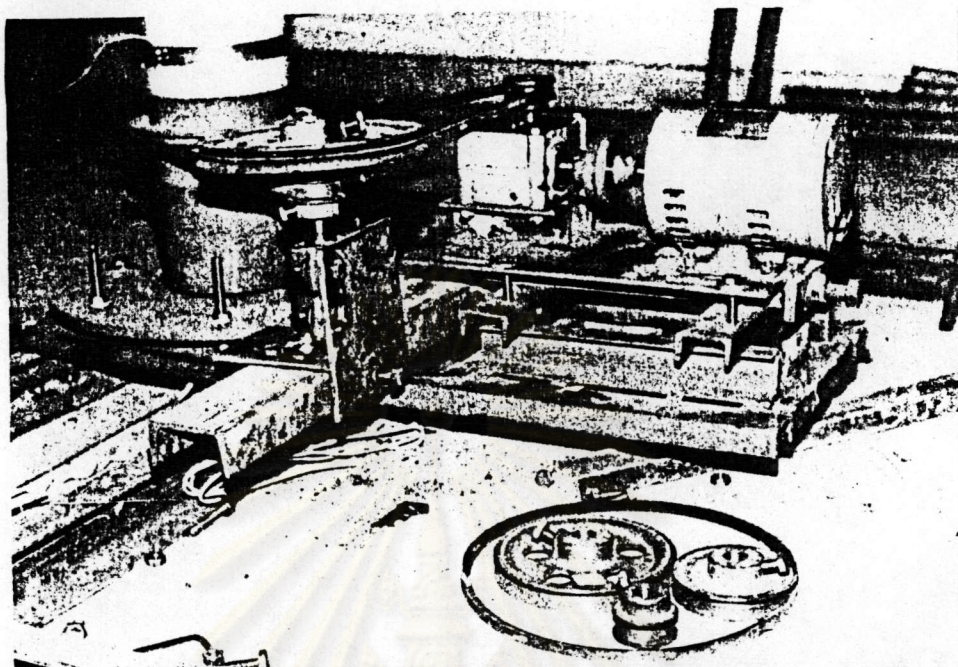

Figure 7 Rotating machine

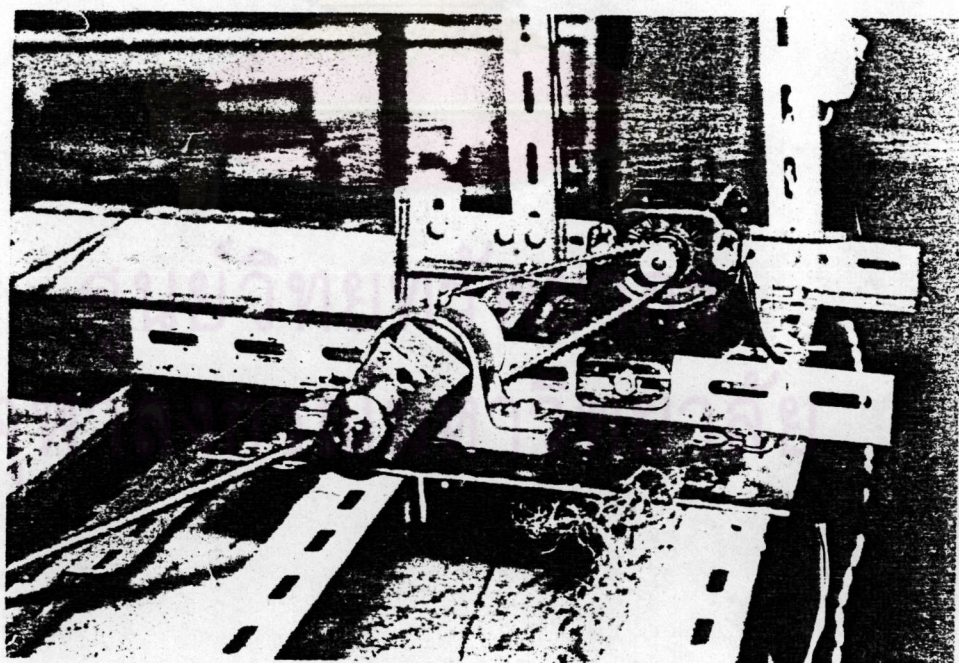

Figure 8 Wave Generator



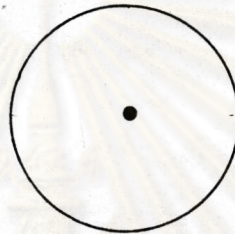
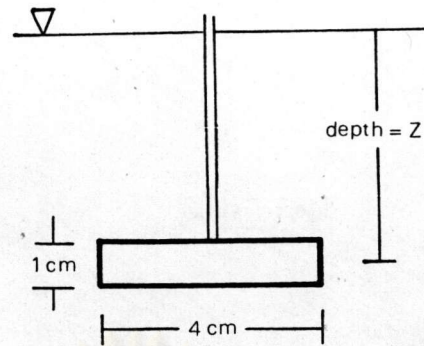

Figure 9 Drifter

Made of wax-filled P.V.C. cylinder.

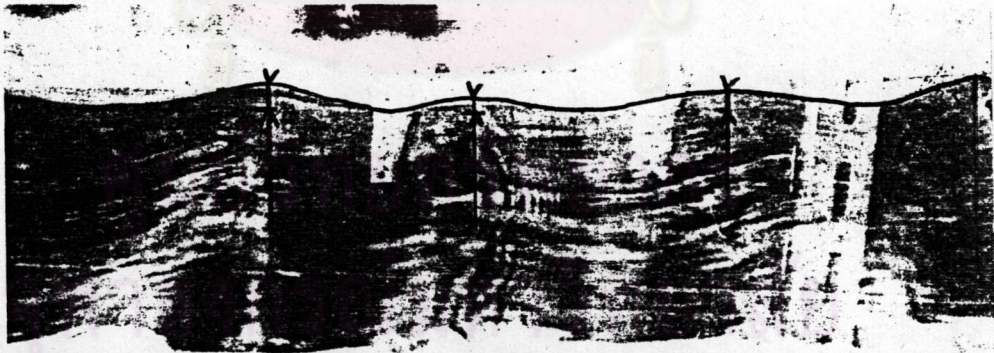

Figure 10 A Picture of the Undulating Water Surface

(From Experiment 7 :  $L = 7.3$  cm

:  $a = 0.4$  cm)



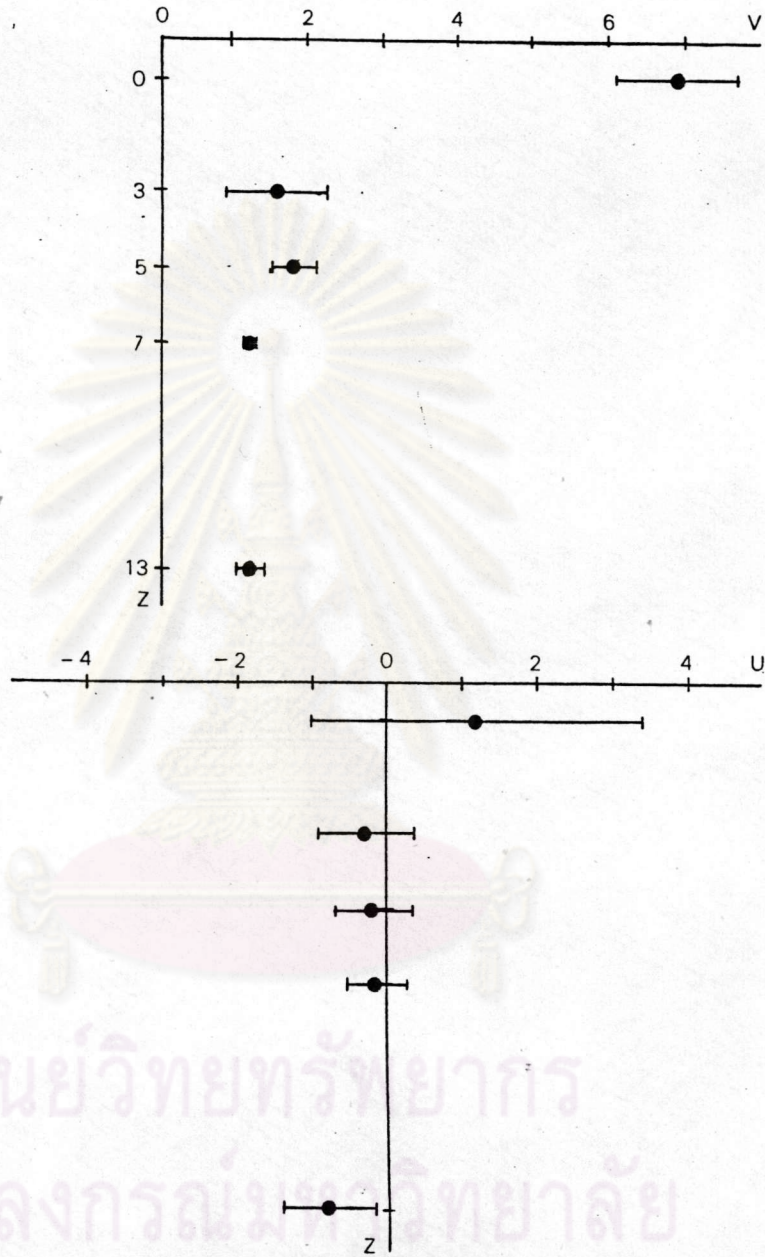

Figure 11.1 Plotted Velocity Distribution for Experiment 1



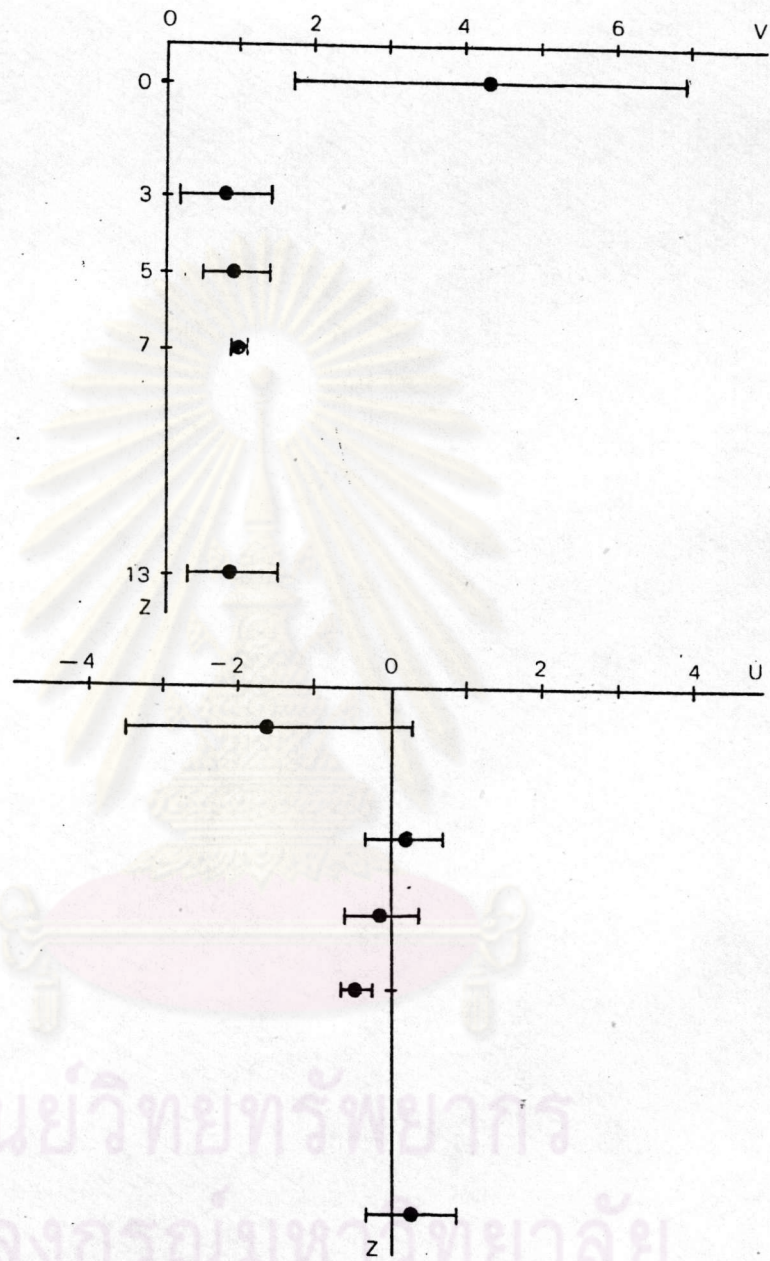
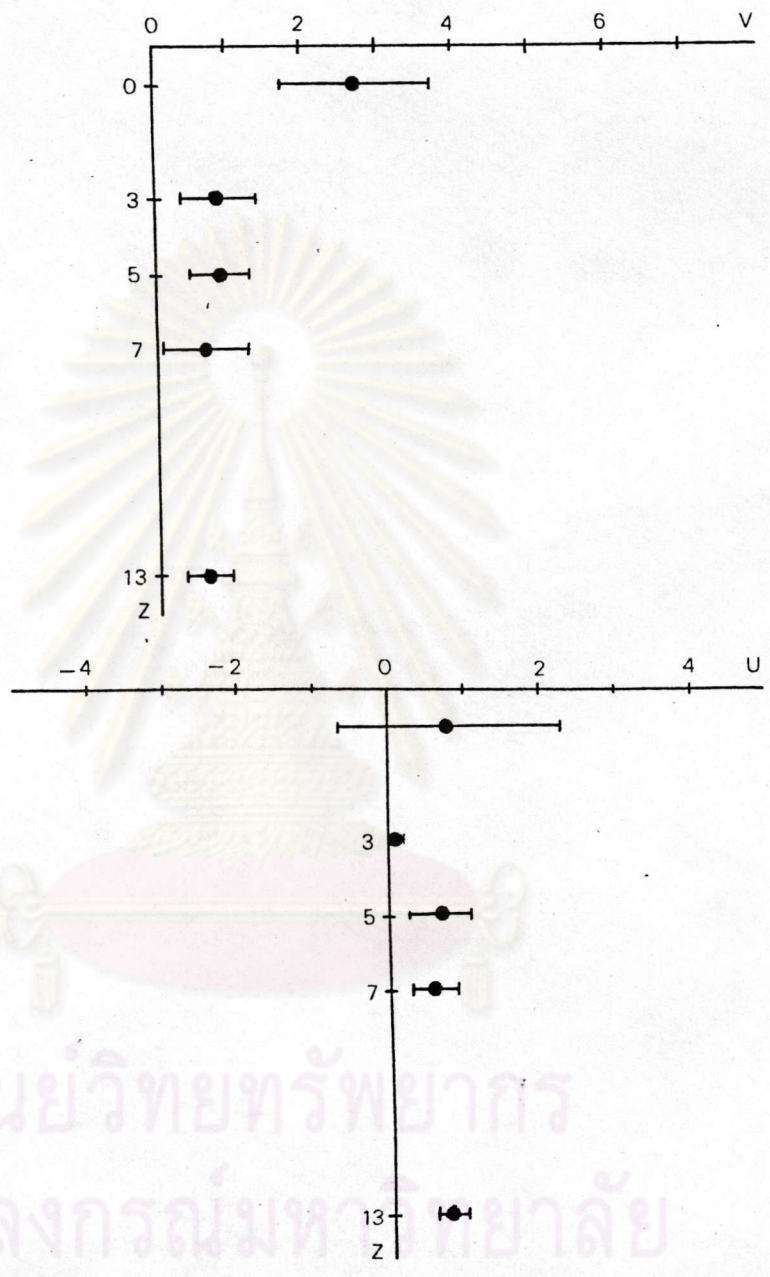

Figure 11.2 Plotted Velocity Distribution for Experiment 2





ศูนย์วิทยทรัพยากร  
จุฬาลงกรณ์มหาวิทยาลัย

Figure 11.3 Plotted Velocity Distribution for Experiment 3



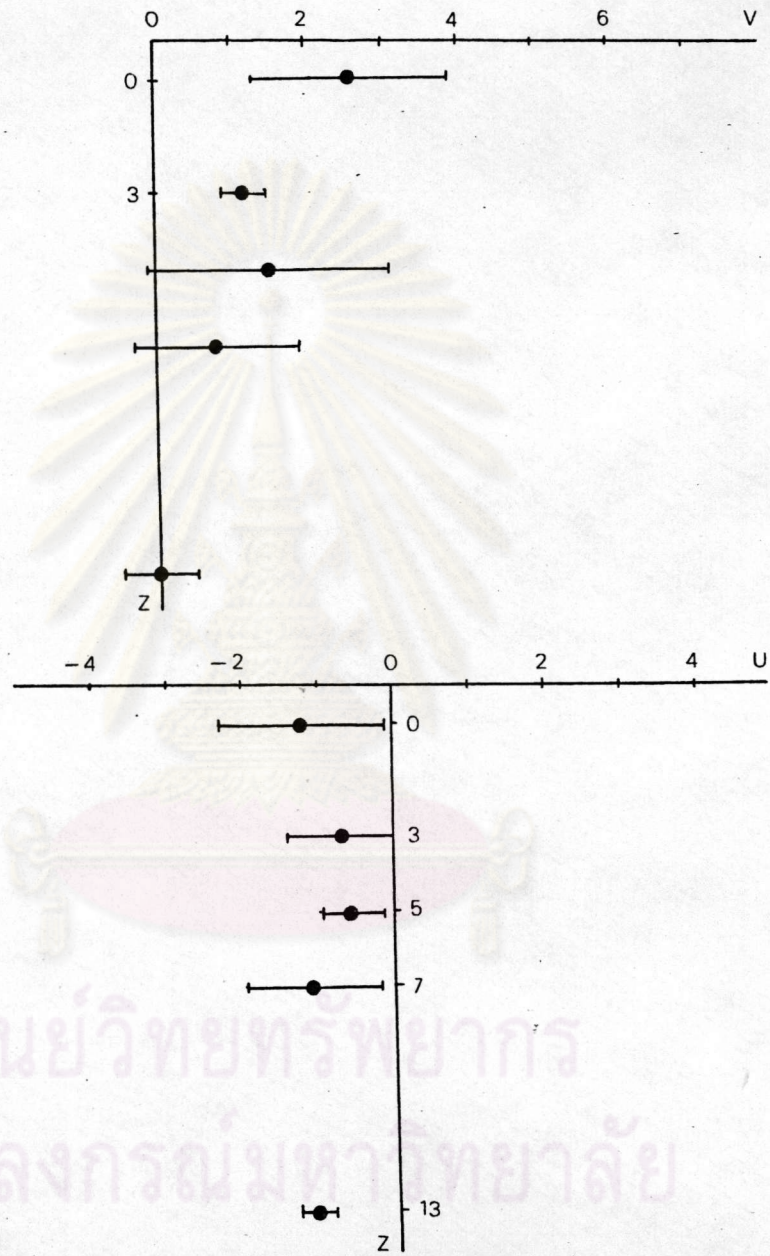

ศูนย์วิทยทรัพยากร  
จุฬาลงกรณ์มหาวิทยาลัย

Figure 11.4 Plotted Velocity Distribution for Experiment 4



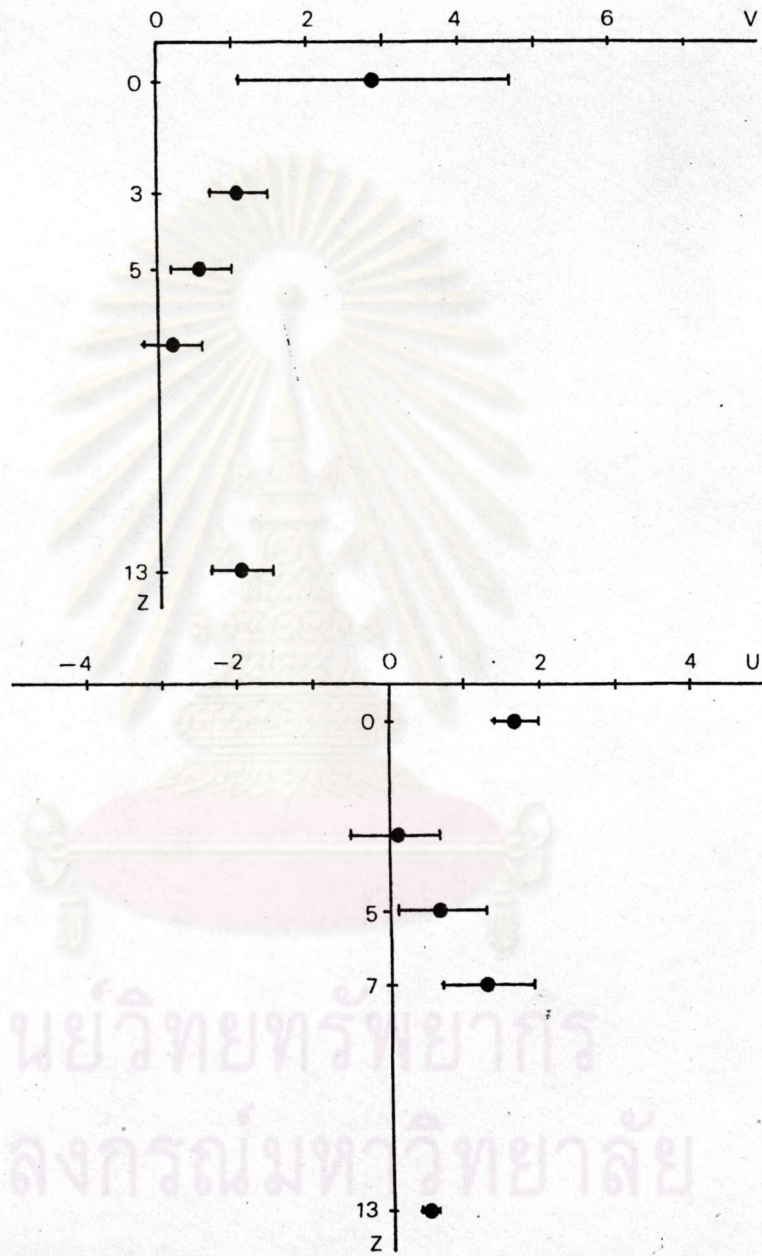

Figure 11.5 Plotted Velocity Distribution for Experiment 5



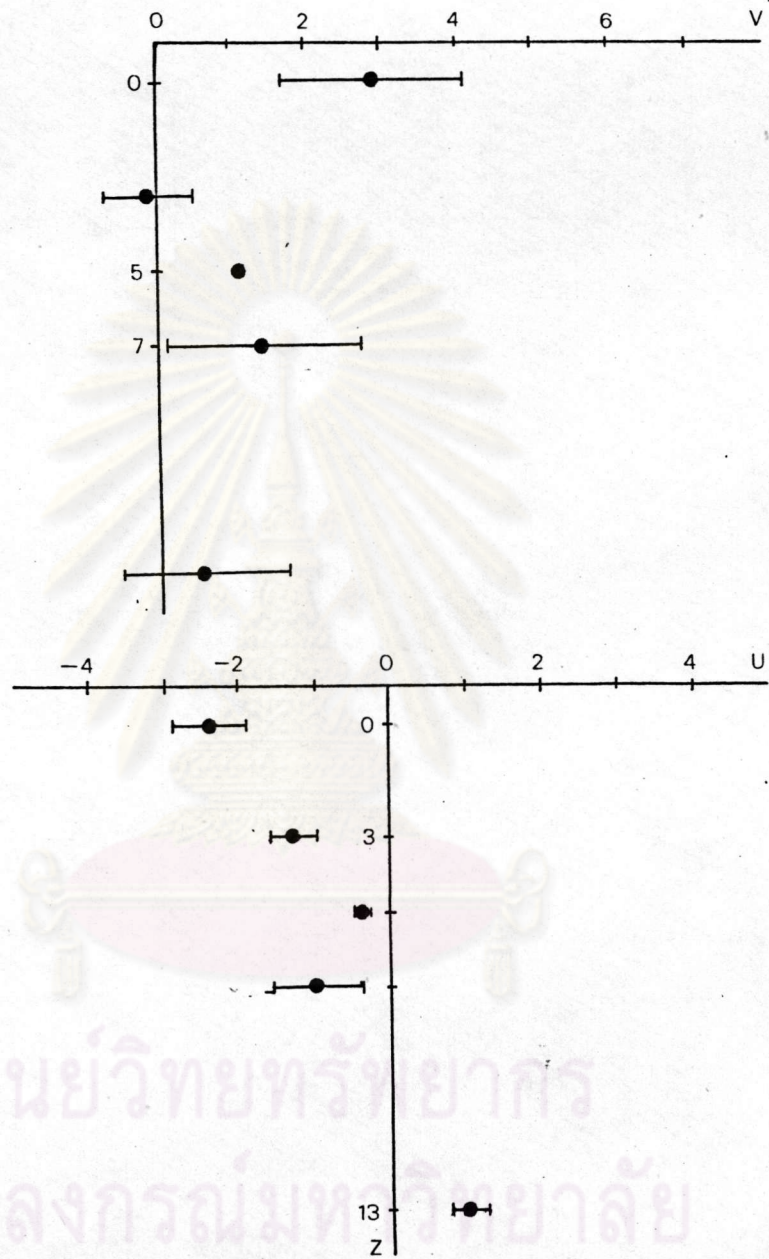

Figure 11.6 Plotted Velocity Distribution for Experiment 6



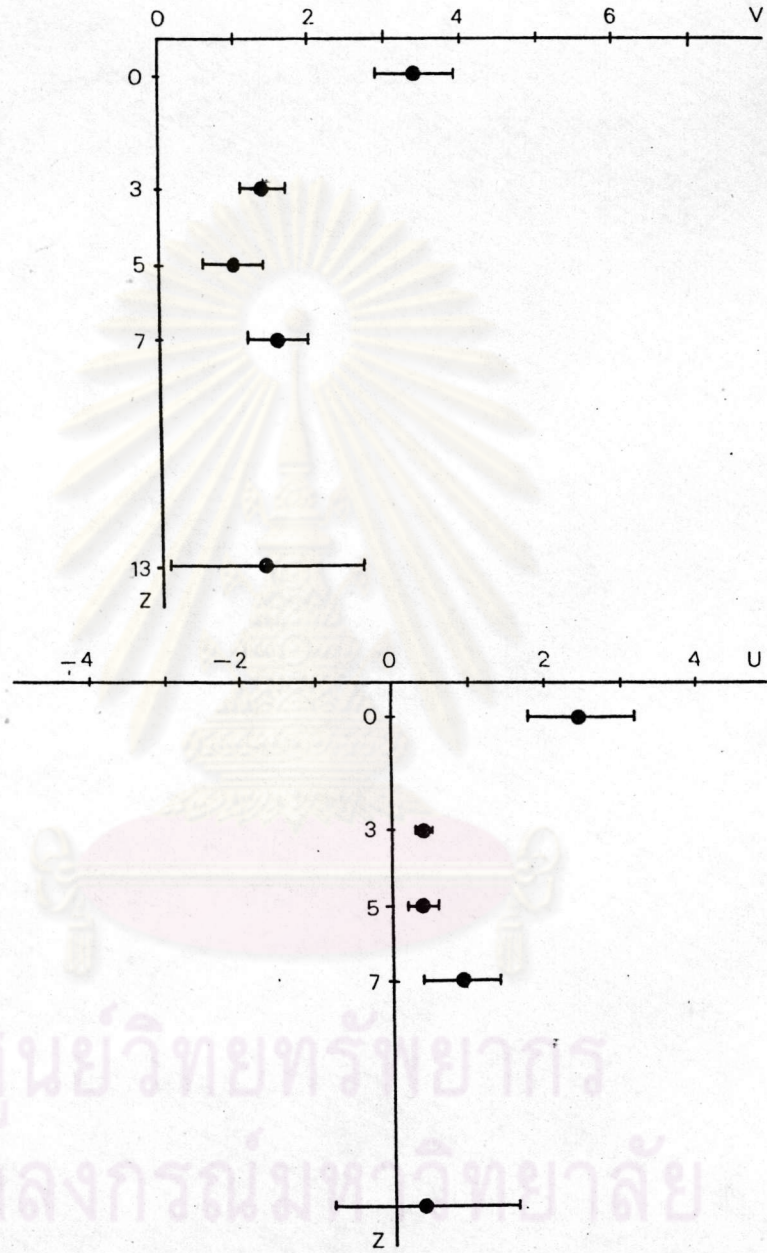

Figure 11.7 Plotted Velocity Distribution for Experiment 7



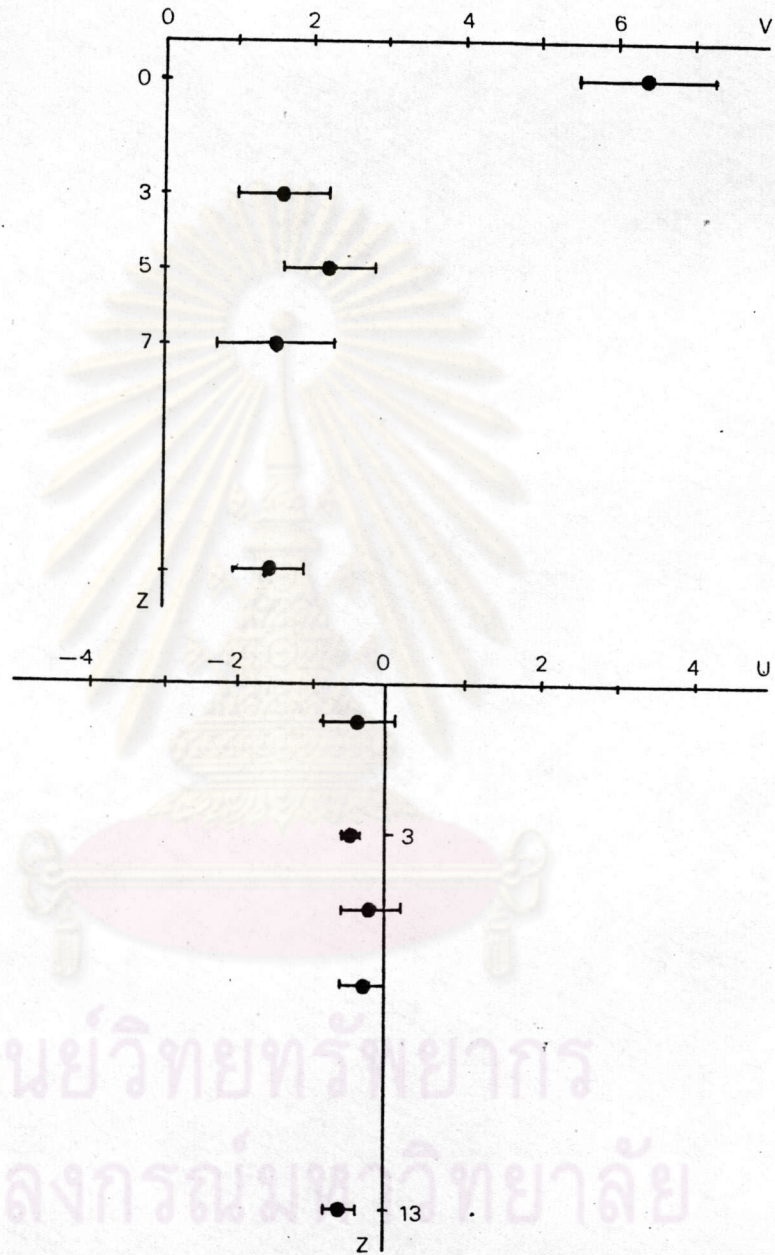

Figure 11.8 Plotted Velocity Distribution for Experiment 8



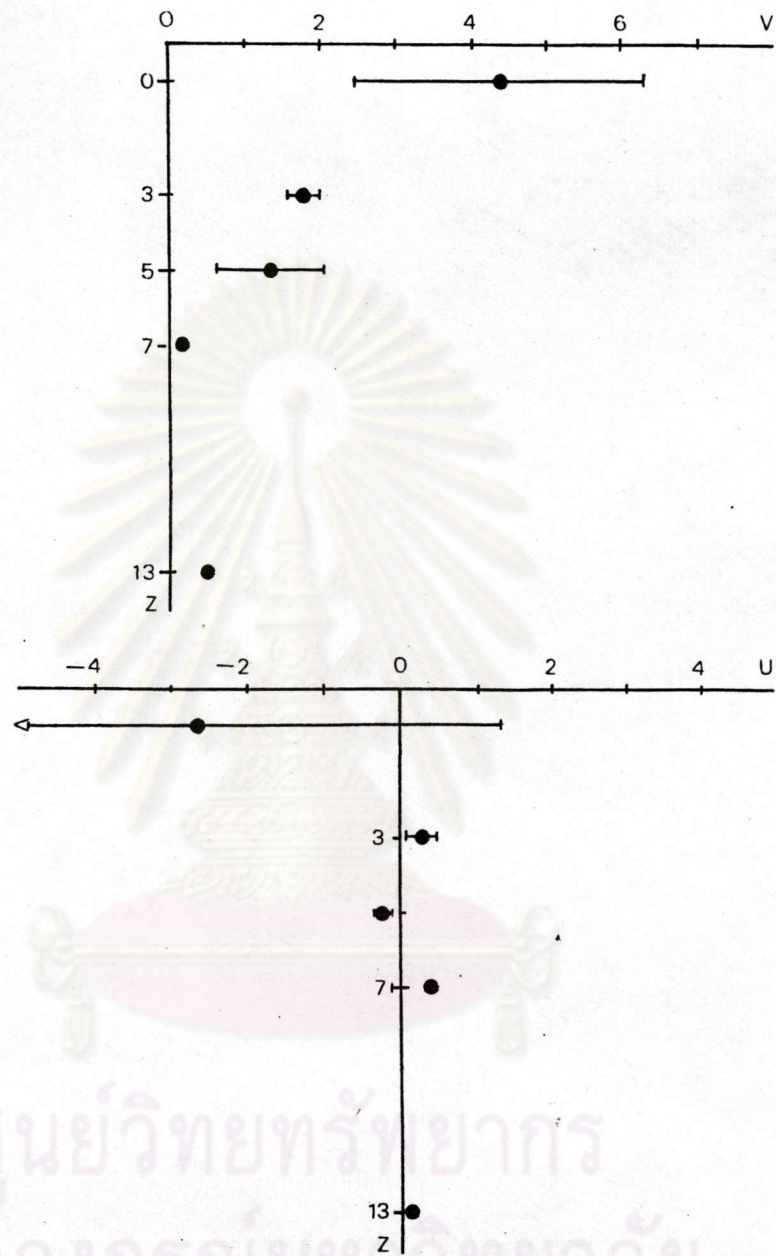

Figure 11.9 Plotted Velocity Distribution for Experiment 9