

Chapter IV

EXPERIMENTAL RESULTS AND DISCUSSIONS

4.1 Experimental results

The cell dimensions of Stemonone crystal were determined from the powder, rotation and Weissenberg photographs. Table 11 shows the cell dimensions determined from various methods. The crystal habit and lattice of Stemonone crystal are shown in Fig. 20.

Table 11

Experimental results

Parameter Method	a Å	b Å	c Å	α degree	β degree	γ degree
I	9.782	12.903	8.210	92.950	103.883	124.700
II	9.929	12.730	8.221	92.800	104.583	125.450
III	9.885	12.764	8.210	90.000	104.045	125.050
IV	9.748	12.866	8.198	90.956	103.566	124.580
V*	12.73	9.90	8.25	105.40	90.00	124.70
VI*	12.864	9.748	8.192	103.564	90.955	124.605

From Table 11; Method I is the results obtained from the powder photograph calculated by using a desk calculator.

Methods II, III are the results determined from the rotation and Weissenberg photographs about [010] axis, [001] axis respectively.

* The parameter pairs (a, α) and (b, β) are interchanged.

Method IV is the refined cell dimensions determined from the powder photograph, the calculation being performed on the NE/C 2200 computer at the Computer Science Unit, Chulalongkorn University.

Method V is the results reported by W. Chaipayungpun, obtained from the rotation and Weissenberg photographs about [001] axis.

Method VI is the refined cell dimensions obtained from the powder photograph as calculated on the CDC 3600 computer, using program CELSIUS at the Institute of Chemistry, University of Uppsala, Sweden, by Miss S. Pramatus.

From the Integrating-Weissenberg photographs along the C rotational axis (0-th to 3-rd layer), the intensities data were collected by using a microdensitometer. The measured intensities, suitably corrected for Lorentz and polarization factors, were transformed into the structure factors on the NEAC 2200 computer.

4.2 Discussions

The data presented are in good agreement with those reported by W. Chaipayungpun (1970). The only major difference is the interchange of the assignment of the parameter pairs (a, α) and (b, β) . The assignment in this thesis follows the convention of the right hand rule and the condition $b > a > c$. This choice of the triclinic cell can be selected in an infinite number of ways from a triclinic space lattice. However, the

cell for which the three shortest noncoplanar translations are chosen to define its edges is unique.

The refined cell dimensions calculated from the powder photograph on the NEC 2200 computer are nearly the same as the one calculated on the CDC 3600. The calibration coefficient, $\frac{\theta}{s-s_0}$, read from the curve $s-s_0$ vs. $\frac{\theta}{s-s_0}$ for Stemonone crystal using CoF_3 as an internal standard substance calculated by using a desk calculator are similar to that obtained by using a CDC 3600 computer. The latter is obtained by averaging each value.

Before an investigation of the crystal structure can be undertaken, the cell parameters should be known. With all intensity data of reflections on hand, the sets of coordinates x, y, z for each of the atoms are then proposed, which are consistent with the structure factors - since these factors depend on the arrangement of atoms in the specific crystal. If the coordinates x_j, y_j and z_j of the j^{th} atom of the cell are proposed correctly, the calculated structure factors can be computed from the equation:

$$F_{hkl} = \sum_j f_j 2\pi i (hx_j + ky_j + lz_j)$$

where f_j is the atomic structure factor.

This stage may take various forms depending on the complexity of the structure being analyzed, and the complexity of the structure depends upon the number of parameters which must be fixed, as well as, on their relation to one another.

The beginning of solving the structure is to measure the intensity of each reflection. After the correction for the Lorentz and polarization factors, the observed structure factors were computed. If all observed structure factors are in harmony with those computed from the proposed structure, the crystal structure are then found.

When a structure of Stemonone crystal ($C_{19}H_{14}O_8$), which was found to be in triclinic system with 2 molecules in a large unit cell, is to be investigated, it is necessary to measure the intensities of all reflections from many layers. In order to get the definite number of reflections, $CuK\alpha$ radiation was used to take the Integrating Weissenberg photographs. But the crystal structure could hardly be solved directly in the absence of any heavy atom. It would be possible to solve the structure by direct methods given sufficiently accurate diffraction data. However, the observed structure factors of Stemonone crystal were collected from the measured intensities of each reflections which was corrected for the Lorentz and polarization factors. The effects of absorption factors are ignored since the Stemonone crystal being used is in a rod shape of the approximate dimensions $0.3 \times 0.05 \times 0.7$ mm. The corrections for the Lorentz and polarization factors is necessary for a study of structure. It is the method of approaching the structure determination. Although the number of the observed structure factors obtained in the present work is not large enough to complete the determination of the structure, the data obtained so far on Stemonone is in

itself of great value, and it is on the right way for a study of the stemonone crystal structure.

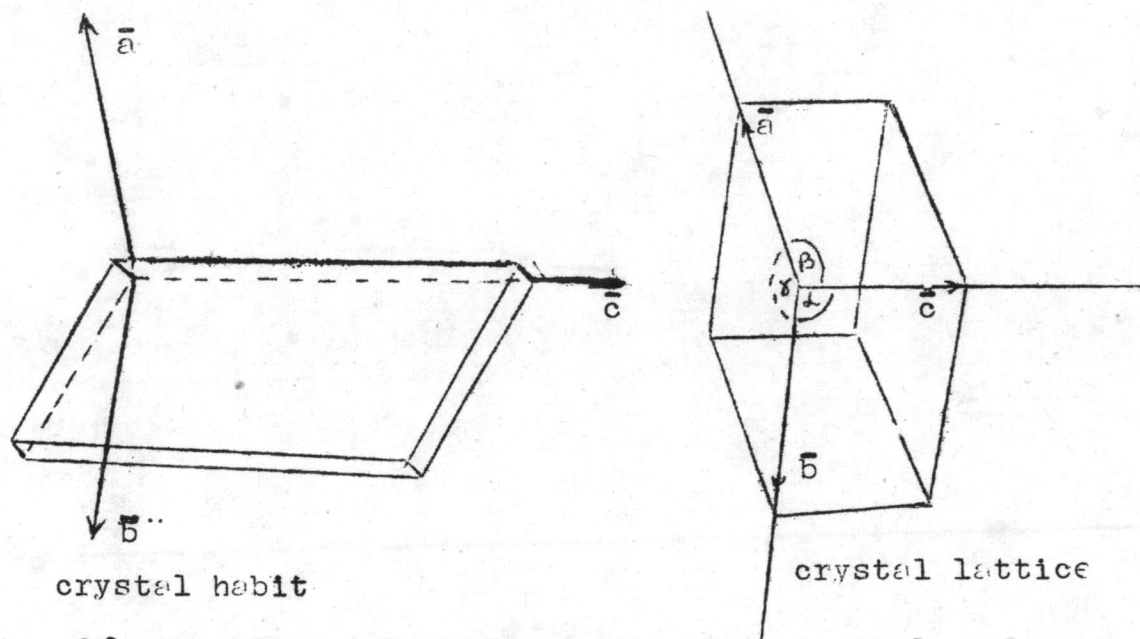

Fig. 20 Habit and lattice of Stemonone crystal.

The self consistent results are :

$$\begin{array}{rcl}
 a & = & 9.748 \pm .002 \text{ \AA} \\
 b & = & 12.866 \pm .002 \text{ \AA} \\
 c & = & 8.198 \pm .002 \text{ \AA} \\
 V & = & 808.2 \text{ (\AA)}^3
 \end{array}
 \quad
 \begin{array}{rcl}
 \alpha & = & 90.956 \pm .004^\circ \\
 \beta & = & 103.566 \pm .003^\circ \\
 \gamma & = & 124.580 \pm .003^\circ
 \end{array}$$

APPENDIX

Table 12
Indices of spots of reflection
[010]



k=0		k=1	
5	1	h	1
0	1	0	2
0	2	0	3
0	3	0	4
0	4	0	5
0	5	0	6
0	6	0	7
0	7	0	8
1	0	1	1
1	1	1	2
1	2	1	3
1	3	1	4
1	4	1	5
1	5	1	6
2	0	2	7
2	1	2	8
2	2	2	1
2	3	2	2
2	4	2	3
2	5	2	4
2	6	2	5
2	7	2	6
2	8	2	7
3	0	3	8
3	1	3	1
3	2	3	2
3	3	3	3
3	4	3	4
3	5	3	5
3	6	3	6
3	7	3	7
3	8	3	8
4	0	4	1
4	1	4	2
4	2	4	3
4	3	4	4
4	4	4	5
4	5	4	6
4	6	4	7
4	7	4	8
4	8	4	1
5	0	5	2
5	1	5	3
5	2	5	4
5	3	5	5
5	4	5	6
5	5	5	7
5	6	5	8
5	7	5	1
5	8	5	2
6	0	6	3
6	1	6	4
6	2	6	5
6	3	6	6
6	4	6	7
6	5	6	8
6	6	6	1
6	7	6	2
6	8	6	3
7	0	7	4
7	1	7	5
7	2	7	6
7	3	7	7
7	4	7	8
7	5	7	1
7	6	7	2
7	7	7	3
7	8	7	4
8	0	8	5
8	1	8	6
8	2	8	7
8	3	8	8
8	4	8	1
8	5	8	2
8	6	8	3
8	7	8	4
8	8	8	5

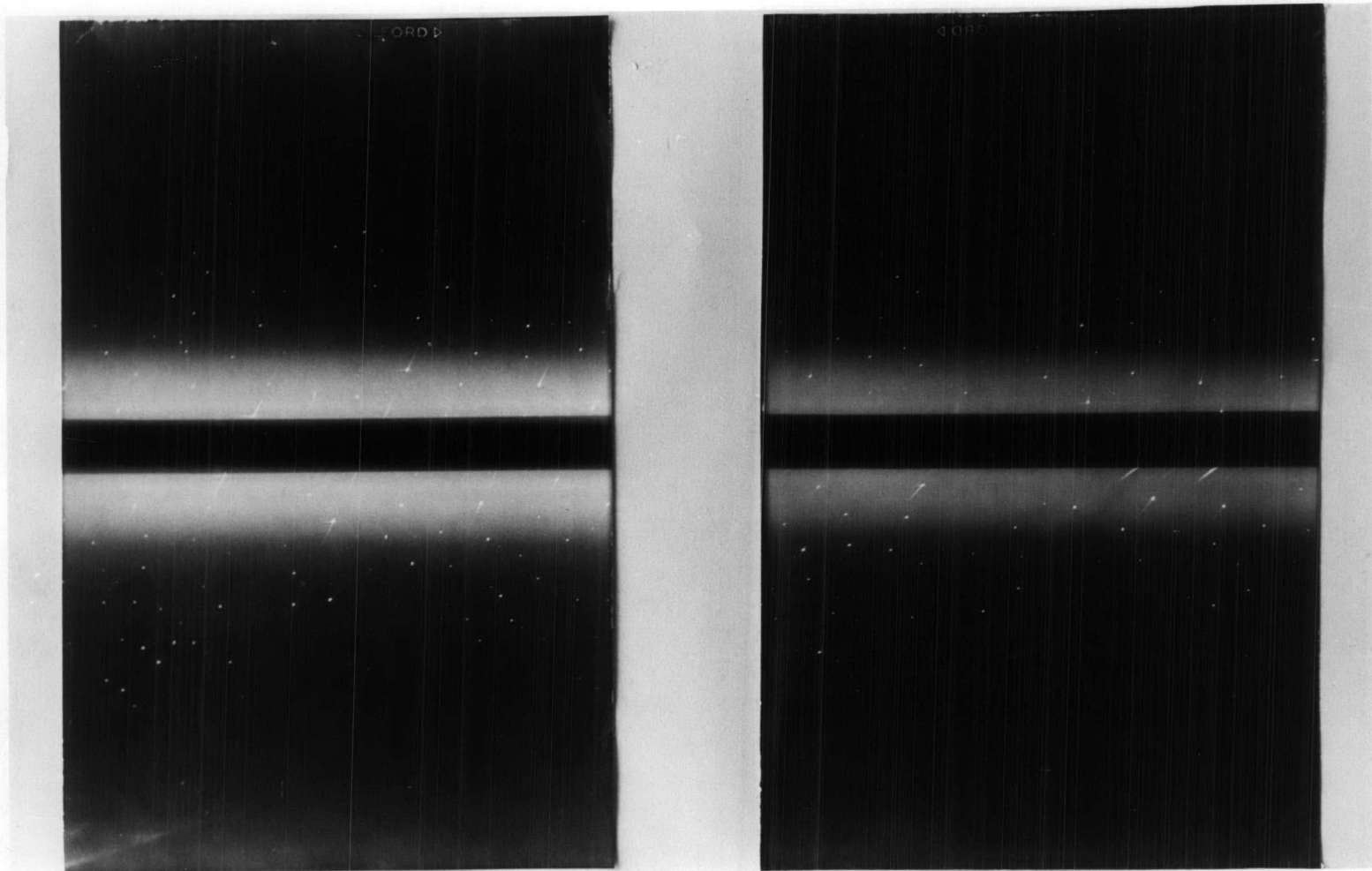

(a) $[010]$ 0-th layer

(b) $[010]$ 1-st layer

Fig.21 Weissenberg photographs

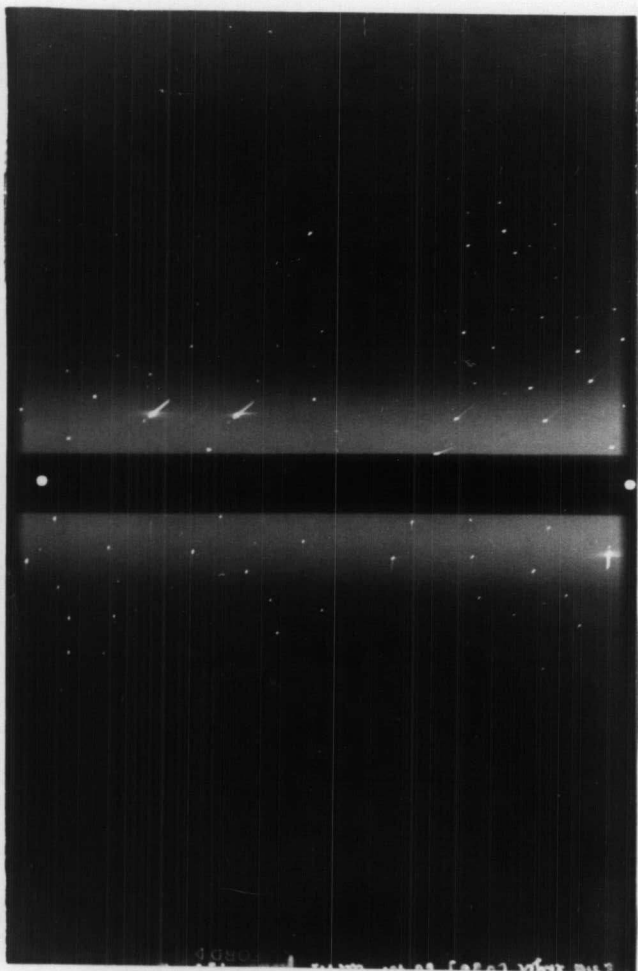

(c) [010] 2-nd layer

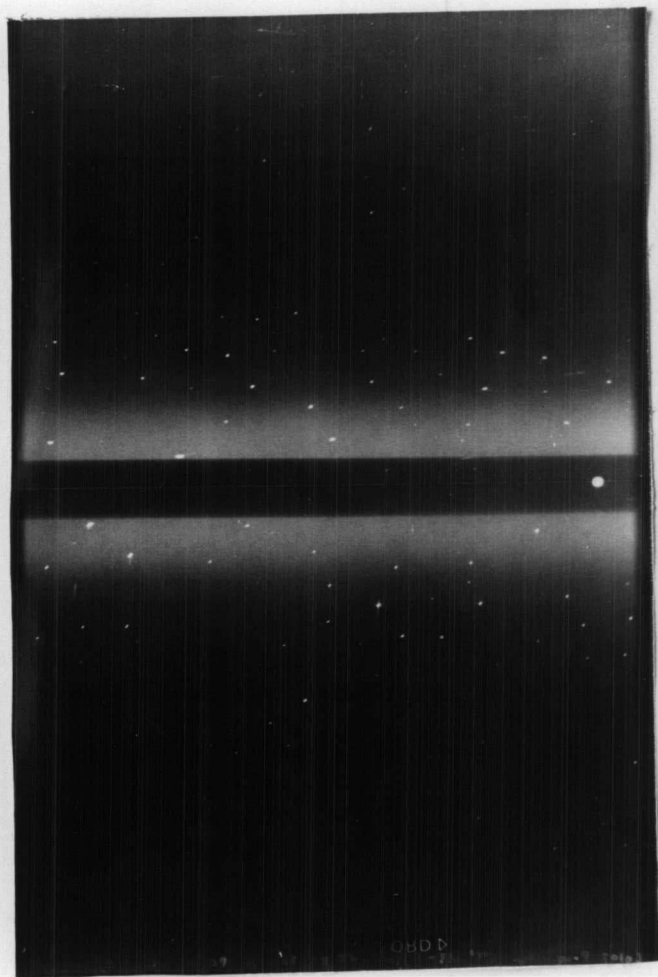

(d) [010] 3-rd. layer

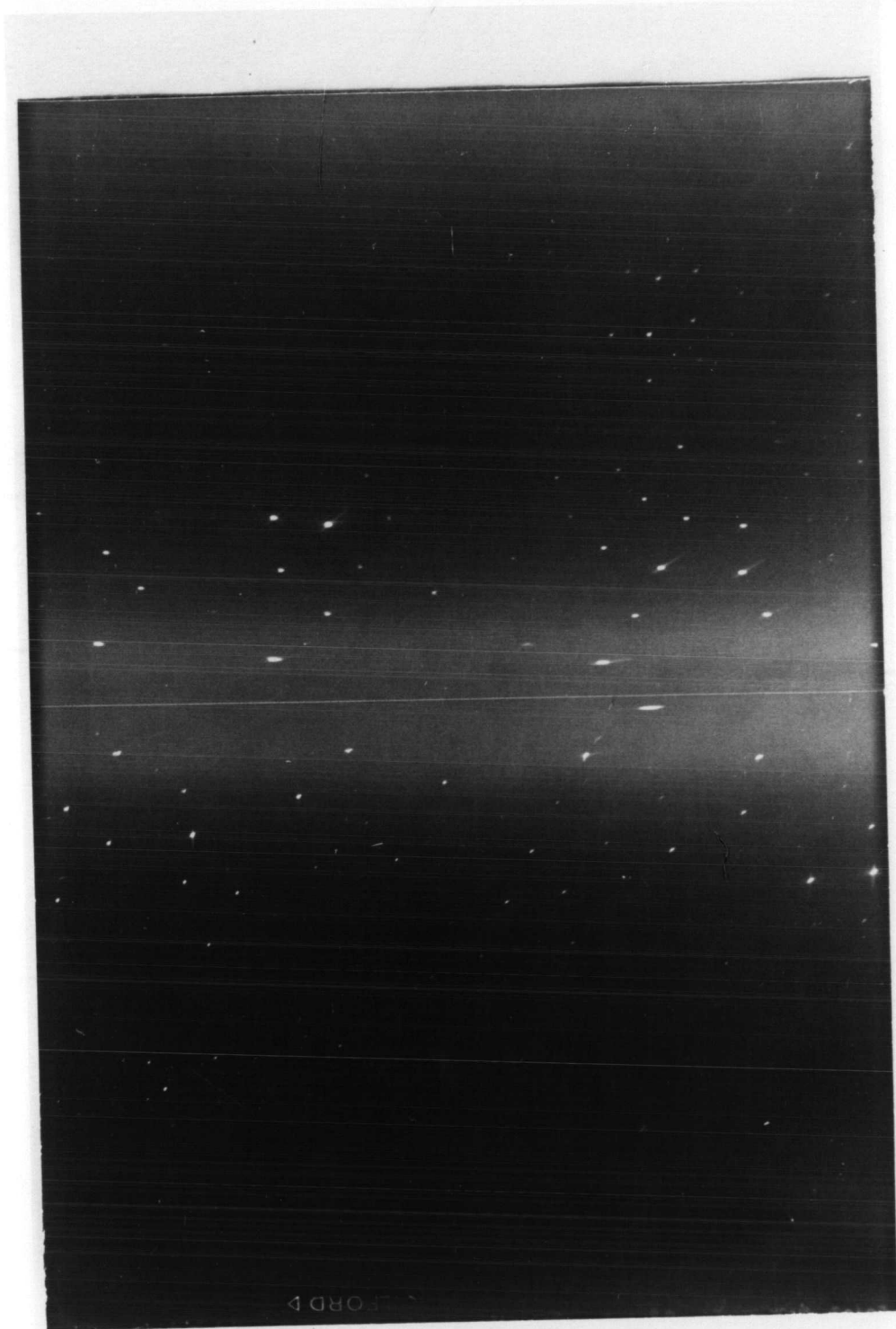

ORD

(e)

[010] 4-th layer

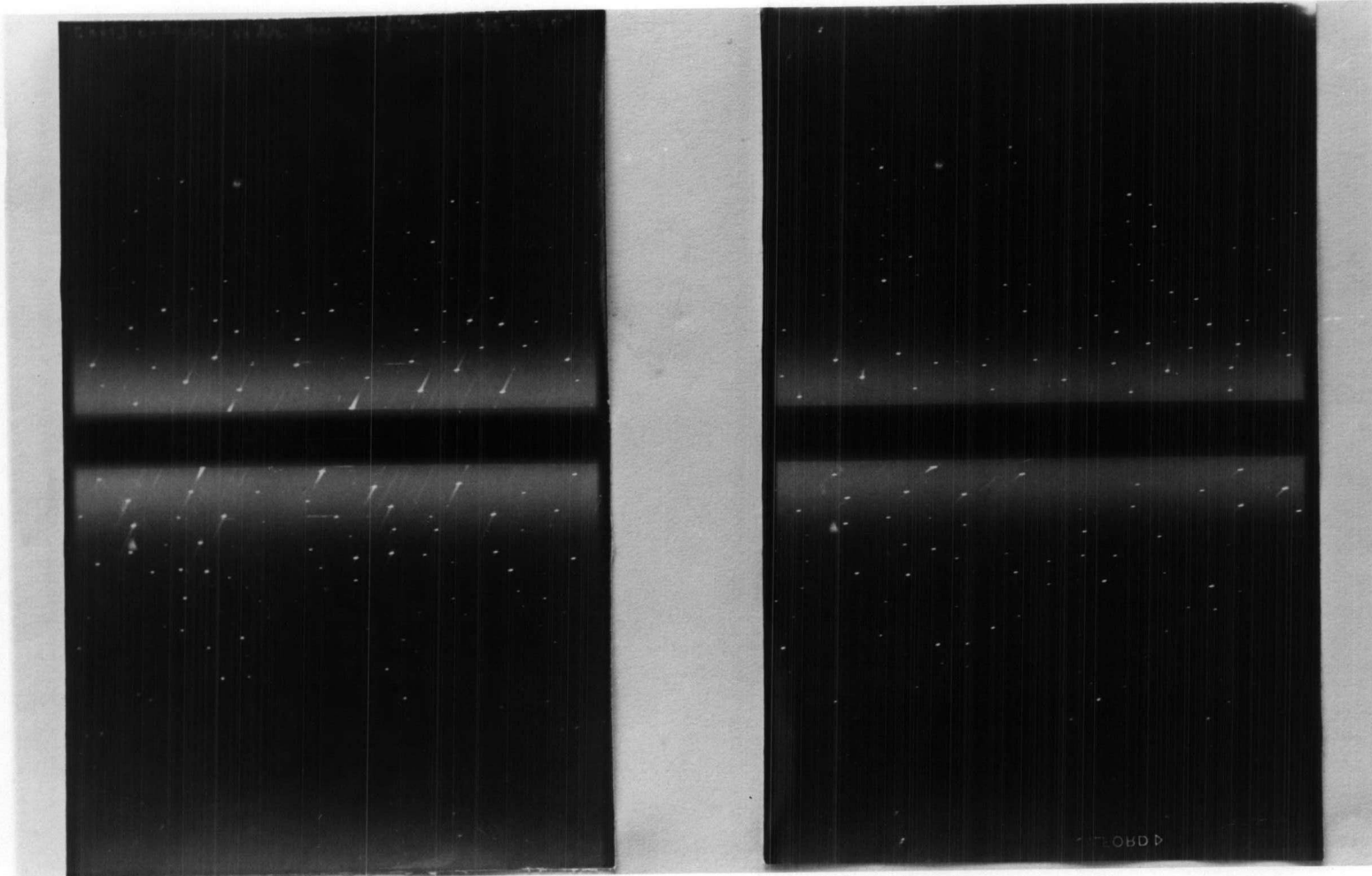

(f) [001] 0-th layer

(g) [001] 1-st layer

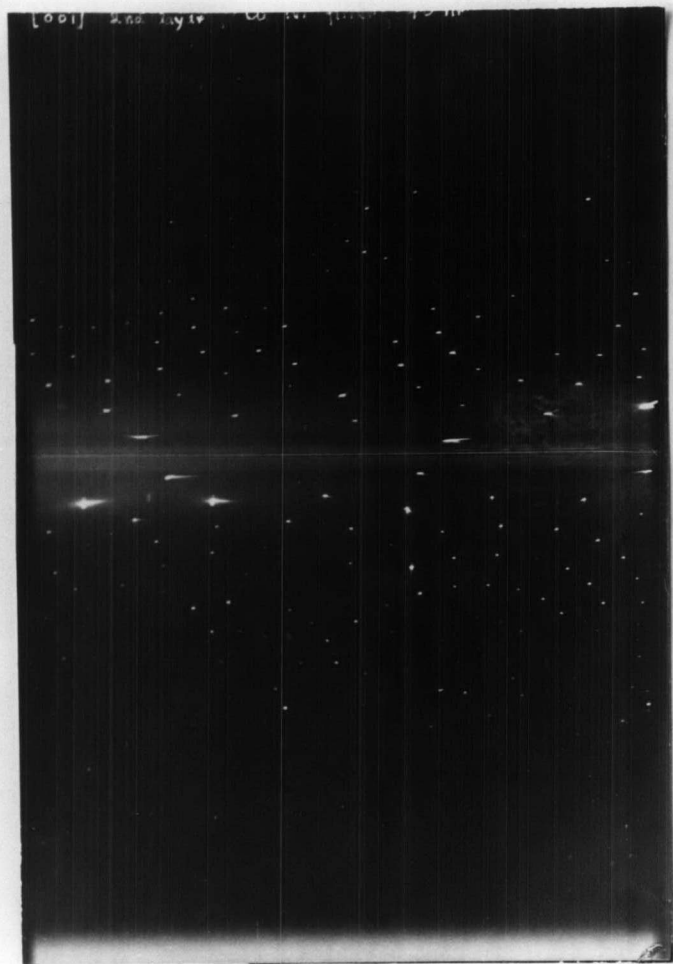

(h) [001] 2-nd layer

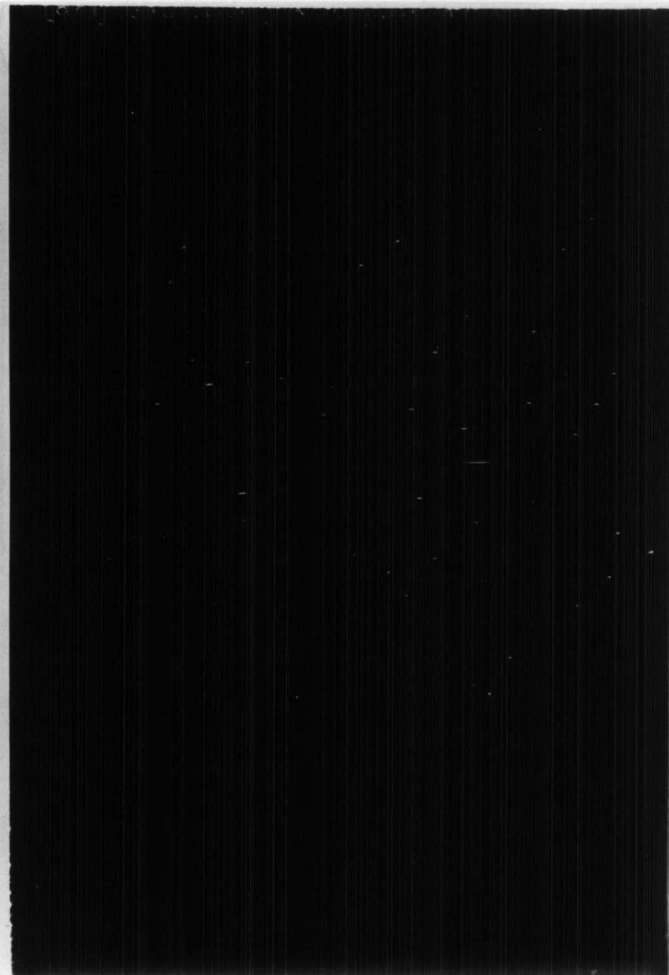

(i) [001] 3-rd layer

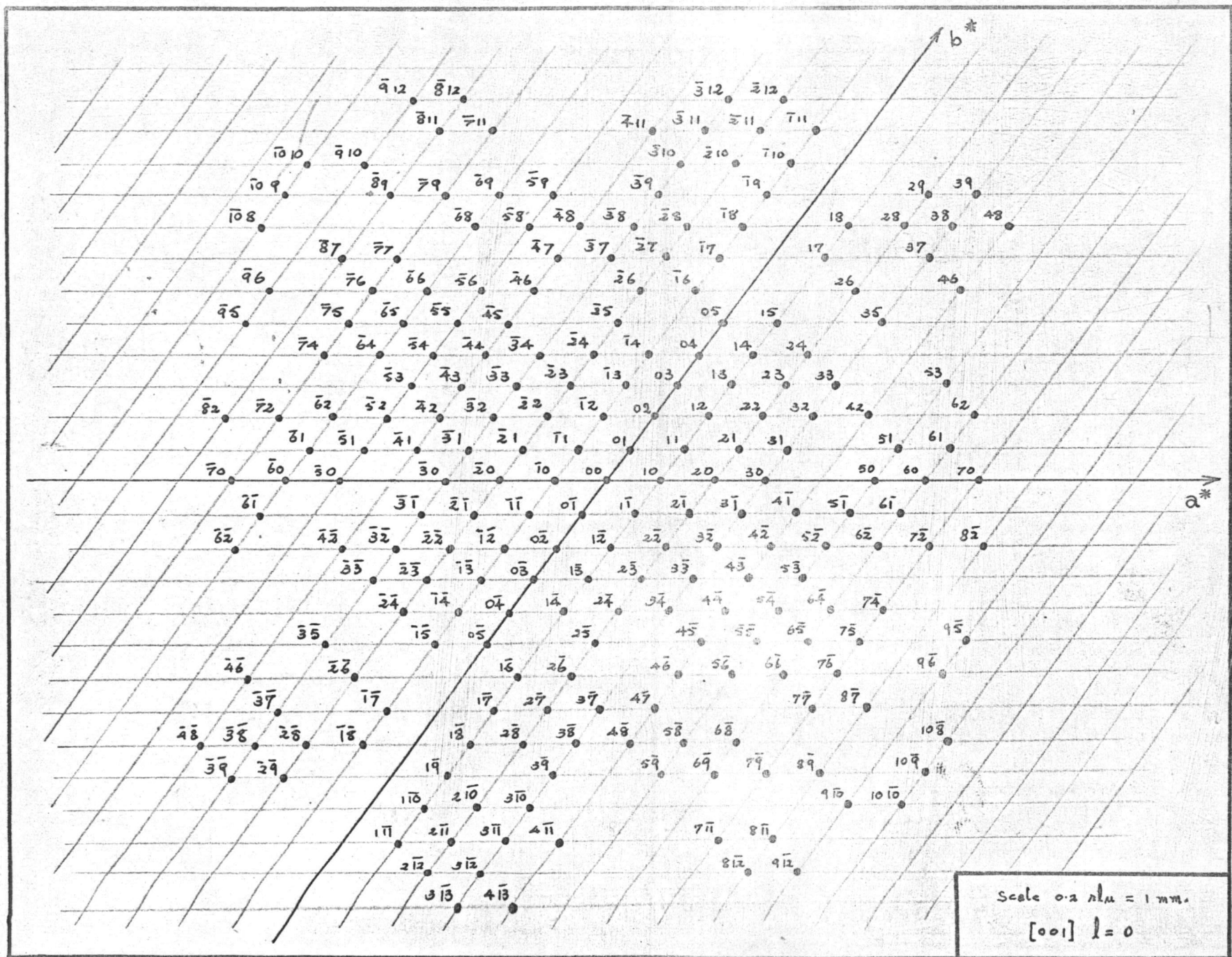

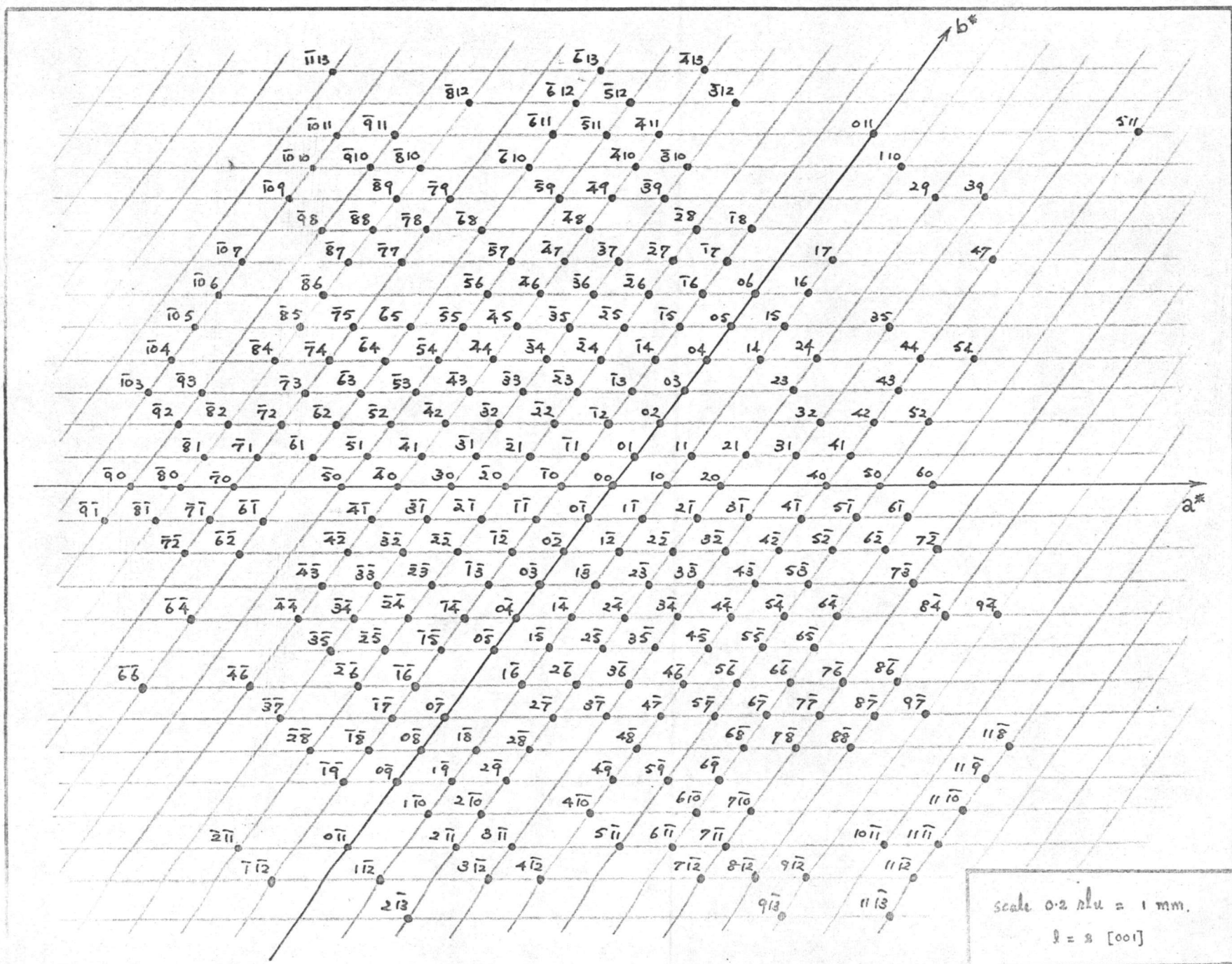

scale 0.2 nlu = 1 mm.
 $l = a [001]$