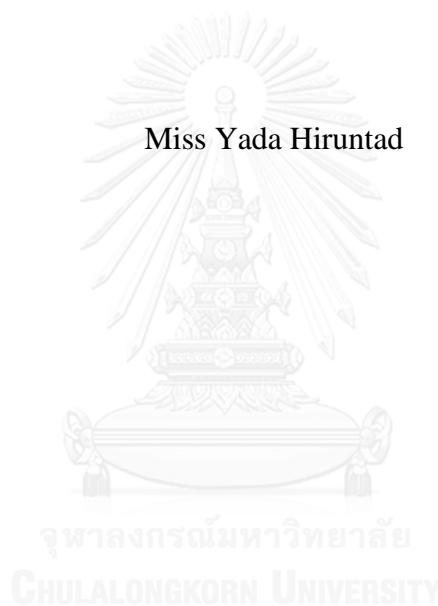


PHARMACOGNOSTIC SPECIFICATION AND QUANTITATIVE ANALYSIS OF  
STRYCHNINE AND BRUCINE IN *STRYCHNOS NUX-VOMICA* SEEDS

Miss Yada Hiruntad



บทคัดย่อและแฟ้มข้อมูลฉบับเต็มของวิทยานิพนธ์ตั้งแต่ปีการศึกษา 2554 ที่ให้บริการในคลังปัญญาจุฬาฯ (CUIR)  
เป็นแฟ้มข้อมูลของนิสิตเจ้าของวิทยานิพนธ์ ที่ส่งผ่านทางบัณฑิตวิทยาลัย

The abstract and full text of theses from the academic year 2011 in Chulalongkorn University Intellectual Repository (CUIR)  
are the thesis authors' files submitted through the University Graduate School.

A Thesis Submitted in Partial Fulfillment of the Requirements  
for the Degree of Master of Science Program in Public Health Sciences  
College of Public Health Sciences  
Chulalongkorn University  
Academic Year 2015  
Copyright of Chulalongkorn University

ข้อกำหนดทางเภสัชวิทยาและการวิเคราะห์ปริมาณสารสกัดกึ่งกับบรูซิโนในเมล็ดแสลงใจ



วิทยานิพนธ์นี้เป็นส่วนหนึ่งของการศึกษาตามหลักสูตรปริญญาวิทยาศาสตรมหาบัณฑิต

สาขาวิชาวิทยาศาสตร์สาธารณสุข

วิทยาลัยวิทยาศาสตร์สาธารณสุข จุฬาลงกรณ์มหาวิทยาลัย

ปีการศึกษา 2558

ลิขสิทธิ์ของจุฬาลงกรณ์มหาวิทยาลัย

Thesis Title	PHARMACOGNOSTIC SPECIFICATION AND QUANTITATIVE ANALYSIS OF STRYCHNINE AND BRUCINE IN <i>STRYCHNOS NUX-VOMICA</i> SEEDS
By	Miss Yada Hiruntad
Field of Study	Public Health Sciences
Thesis Advisor	Assistant Professor Chanida Palanuvej, Ph.D.
Thesis Co-Advisor	Associate Professor Nijsiri Ruangrunsi, Ph.D.

---

Accepted by the College of Public Health Sciences, Chulalongkorn  
University in Partial Fulfillment of the Requirements for the Master's Degree

..... Dean of the College of Public Health Sciences  
(Professor Sathirakorn Pongpanich, Ph.D.)

#### THESIS COMMITTEE

..... Chairman  
(Assistant Professor Naowarat Kanchanakhan, Ph.D.)

..... Thesis Advisor  
(Assistant Professor Chanida Palanuvej, Ph.D.)

..... Thesis Co-Advisor  
(Associate Professor Nijsiri Ruangrunsi, Ph.D.)

..... External Examiner  
(Associate Professor Uthai Sotanaphun, Ph.D.)

ญาดา หิริญเทศ : ข้อกำหนดทางเภสัชเวทและการวิเคราะห์ปริมาณสารสกัดนินกับบรูชินในเมล็ดแสดงใจ (PHARMACOGNOSTIC SPECIFICATION AND QUANTITATIVE ANALYSIS OF STRYCHNINE AND BRUCINE IN *STRYCHNOS NUX-VOMICA* SEEDS) อ.ที่ปริกษาวิทยานิพนธ์หลัก: ผศ. ดร.ชนิดา พลานูเวช, อ.ที่ปริกษาวิทยานิพนธ์ร่วม: รศ. ดร.นิจศิริ เรืองรัมย์, 102 หน้า.

แสดงใจมีชื่อทางวิทยาศาสตร์ว่า *Strychnos nux-vomica* Linn. เป็นพืชที่มีสรรพคุณในการรักษาและมีความเป็นพิษสูง เมล็ดจากต้นแสดงใจถูกนำมาใช้เป็นเครื่องยาสมุนไพรในทางการแพทย์แผนไทย ดังนั้นการศึกษานี้จึงจัดทำขึ้นเพื่อกำหนดลักษณะทางเภสัชเวทและวิเคราะห์ปริมาณสารสกัดนินกับบรูชินในเมล็ดแสดงใจจาก 15 แหล่งทั่วประเทศไทย ประเมินลักษณะทางมหรรณและจุลทรรศน์ในรูปแบบภาพวาดลายเส้นแสดงลักษณะทางพฤกษศาสตร์ ลักษณะของผงยาและภาพตัดขวางของเครื่องยา ศึกษาคุณสมบัติทางกายภาพและเคมีของเมล็ดแสดงใจพบว่า มีค่าเฉลี่ยปริมาณน้ำ ปริมาณน้ำหนักรที่หายไปเมื่อทำให้แห้ง ปริมาณเถ้ารวม ปริมาณเถ้าที่ไม่ละลายในกรด ปริมาณสิ่งสกัดด้วยเอทานอล และปริมาณสิ่งสกัดด้วยน้ำเท่ากับร้อยละ  $8.08 \pm 0.60$ ,  $8.80 \pm 0.25$ ,  $1.20 \pm 0.03$ ,  $0.15 \pm 0.02$ ,  $3.90 \pm 0.33$  และ  $13.12 \pm 0.77$  โดยน้ำหนัก ตามลำดับ ตรวจสอบองค์ประกอบทางเคมีด้วยวิธีโครมาโทกราฟีพีชนิดแผ่นบาง โดยใช้แผ่น ซิลิกาเจล 60 GF<sub>254</sub> เป็นวัฏภาคคงที่และมีตัวทำละลายโทลูอิน เอทิลอะซิเตต และ ไดเอทิลเอมีน ในอัตราส่วน (7: 2: 1) เป็นวัฏภาคเคลื่อนที่และตรวจวัดภายใต้แสงอัลตราไวโอเล็ต 254 และ 365 นาโนเมตร ใช้น้ำยาเฟนตราเจนคอรอฟตรวจสอบโดยเฉพาะเจาะจงต่อสารอัลคาลอยด์ วิเคราะห์ปริมาณสารสกัดนินกับบรูชินโดยวิธีโครมาโทกราฟีชนิดแผ่นบางและวิเคราะห์เชิงภาพโดยใช้โปรแกรม Image J และวิเคราะห์โดยวิธีโครมาโทกราฟีชนิดแผ่นบาง-เดินซีโคมเทรี โดยใช้เครื่อง CAMAG TLC scanner ร่วมกับโปรแกรม winCATS ปริมาณสารสกัดนินกับบรูชินในเมล็ดแสดงใจมีค่าเฉลี่ย  $1.09 \pm 0.56$ ,  $0.48 \pm 0.30$  และ  $1.03 \pm 0.51$ ,  $0.46 \pm 0.28$  กรัม/100 กรัม โดยวิธีทั้งสองตามลำดับ ทั้งสองวิธีที่ใช้วิเคราะห์หาปริมาณมีความเชื่อถือได้ในด้านความจำเพาะ ความสัมพันธ์เชิงเส้น ความแม่นยำ ความเที่ยง ชัดจำกัดในการตรวจสอบ ชัดจำกัดในการวัดเชิงปริมาณและความคงทน ประเมินความเป็นพิษต่อดีเอ็นเอในหลอดทดลองของสารมาตรฐานสกัดนินกับบรูชินและสิ่งสกัดเอทานอลของเมล็ดแสดงใจ พบว่ามีแนวโน้มสร้างความเสี่ยงต่อดีเอ็นเอจากเซลล์เม็ดเลือดขาวเมื่อเปรียบเทียบกับกลุ่มควบคุม โดยสารสกัดนินกับบรูชินมีแนวโน้มทำลายดีเอ็นเอมากกว่าสารบรูชินและสิ่งสกัดเอทานอลของเมล็ดแสดงใจ ตามลำดับ ผลจากการศึกษาในครั้งนี้ สามารถจัดทำเป็นข้อกำหนดทางเภสัชเวทของเมล็ดแสดงใจในประเทศไทย ซึ่งจะเป็ประโยชน์ต่อการควบคุมคุณภาพมาตรฐานของวัตถุุดิบสมุนไพร รวมทั้งความปลอดภัยในการใช้และการศึกษาวิจัยเพื่อพัฒนาเครื่องยาคูณิตต่อไป

สาขาวิชา วิทยาศาสตร์สาธารณสุข

ลายมือชื่อนิสิต .....

ปีการศึกษา 2558

ลายมือชื่อ อ.ที่ปริกษาหลัก .....

ลายมือชื่อ อ.ที่ปริกษาร่วม .....

# # 5778953053 : MAJOR PUBLIC HEALTH SCIENCES

KEYWORDS: STRYCHNOS NUX-VOMICA SEEDS / STRYCHNINE AND BRUCINE / TLC IMAGE ANALYSIS / TLC DENSITOMETRY / PHARMACOGNOSTIC SPECIFICATION / COMET ASSAY

YADA HIRUNTAD: PHARMACOGNOSTIC SPECIFICATION AND QUANTITATIVE ANALYSIS OF STRYCHNINE AND BRUCINE IN *STRYCHNOS NUX-VOMICA* SEEDS. ADVISOR: ASST. PROF. CHANIDA PALANUVEJ, Ph.D., CO-ADVISOR: ASSOC. PROF. NIJSIRI RUANGRUNGSI, Ph.D., 102 pp.

*Strychnos nux-vomica* Linn. or Sa-leang-jai is a medicinal and poisonous plant. *S. nux-vomica* seeds have been used in traditional Thai medicine for a long time. This study aimed to develop quality specification and the quantitative analysis of strychnine and brucine in *S. nux-vomica* seeds. The crude drug samples from 15 sources throughout Thailand were collected to assess the macroscopic and microscopic evaluation. The details were illustrated by drawing of whole plant, powder and cross section characteristics. The physico-chemical properties of *S. nux-vomica* seeds were established in average contents of water, loss on drying, total ash, acid insoluble ash, ethanol and water extractive matters as  $8.08 \pm 0.60$ ,  $8.80 \pm 0.25$ ,  $1.20 \pm 0.03$ ,  $0.15 \pm 0.02$ ,  $3.90 \pm 0.33$  and  $13.12 \pm 0.77$  % by weight respectively. Thin layer chromatographic fingerprint using silica gel 60 GF<sub>254</sub> as stationary phase and toluene: ethyl acetate: diethylamine (7: 2: 1) as mobile phase showed the phytochemical compounds under UV wavelength of 254 and 365 nm and the alkaloids by Dragendorff's developing reagent. The quantitative analysis of strychnine and brucine were performed by TLC image analysis using Image J software and TLC densitometry using CAMAG TLC scanner and winCATS. The contents of strychnine and brucine in *S. nux-vomica* seeds were found to be  $1.09 \pm 0.56$ ,  $0.48 \pm 0.30$  and  $1.03 \pm 0.51$ ,  $0.46 \pm 0.28$  g/100g by both methods respectively. These methods were validated in term of specificity, linearity, accuracy, precision, limit of detection, limit of quantitation and robustness. The toxic potential on DNA damage of strychnine, brucine and ethanolic extract of *S. nux-vomica* seeds were assessed *in vitro*. All treated samples exhibited human lymphocyte DNA damage. Strychnine was more toxic than brucine and the extract respectively. This study provided the quality specification, standardization and safety used of *S. nux-vomica* seeds in Thailand.

Field of Study: Public Health Sciences

Academic Year: 2015

Student's Signature .....

Advisor's Signature .....

Co-Advisor's Signature .....

## ACKNOWLEDGEMENTS

The author wishes to express her heartily gratitude and appreciation to her thesis advisor, Assistant Professor Dr. Chanida Palanuvej, for her continuous guidance, suggestion, and support throughout the course of this study.

The author is sincerely grateful to her thesis co-advisor, Associate Professor Dr. Nijisiri Ruangrunsi, for his kindness and valuable suggestion to complete the present study.

Gratitude is grateful to the thesis committee members, Associate Professor Dr. Uthai Sotanaphun and Assistant Professor Dr. Naowarat Kanchanakhan for their important and constructive suggestion in finalizing this thesis.

The author is thankful to Graduate school, Chulalongkorn University for Teaching Assistant Scholarship.

Appreciation is also extended to College of Public Health Sciences, Chulalongkorn University and all the staff members for necessary assistance and instrumental support.

The author's final thank goes to her family, especially her parents for their love, understanding, encourage and support her to concentrate on her study.

## CONTENTS

	Page
THAI ABSTRACT .....	iv
ENGLISH ABSTRACT.....	v
ACKNOWLEDGEMENTS.....	vi
CONTENTS.....	vii
LIST OF TABLES .....	xii
LIST OF FIGURES .....	xiv
LIST OF ABBREVIATIONS.....	xvi
CHAPTER I INTRODUCTION.....	1
Background and rationale .....	1
Research problems .....	2
Objectives .....	2
Conceptual framework.....	3
CHAPTER II REVIEW LITERATURES .....	4
<i>STRYCHNOS</i> .....	4
<i>Strychnos nux-vomica</i> Linn. ....	5
Ecology .....	5
Plant description .....	6
Traditional uses.....	7
Pharmacological investigations .....	8
Intoxication.....	9
Detoxification.....	9
Cytotoxicity .....	9
Anti-inflammatory.....	9
Chemical compounds.....	10
Strychnine.....	10
Brucine .....	11
Strychnine and brucine in <i>Strychnos</i> species .....	12
Quality specifications of herbal material .....	13

	Page
Authentication .....	13
Foreign matter .....	13
Macroscopic and microscopic evaluation .....	13
Determination of moisture content.....	14
Determination of volatile oil .....	14
Determination of total ash and acid insoluble ash.....	14
Determination of solvent extractive value.....	15
Quantitative analysis.....	15
Chromatographic analysis .....	15
Thin layer chromatography (TLC) .....	15
Detection of compounds.....	16
TLC-densitometry .....	16
TLC-Image J software program .....	16
Method validation .....	17
Specificity.....	17
Range and linearity.....	17
Accuracy.....	17
Precision .....	18
Limit of detection (LOD) .....	18
Limit of quantitation (LOQ).....	18
Robustness.....	19
Genotoxicity .....	19
Comet assay.....	19
CHAPTER III MATERIALS AND METHODOLOGY.....	20
Chemicals and reagents .....	20
Materials .....	20
Instrumentations .....	21
Research methodology.....	22
Sample collections.....	22



	Page
Macroscopic evaluation.....	22
Microscopic evaluation .....	22
Determination of water content (Azeotropic distillation method) .....	23
Determination of loss on drying, total ash and acid insoluble ash .....	24
Determination of ethanol soluble extractive value.....	24
Determination of water soluble extractive value.....	24
Thin layer chromatographic fingerprint .....	25
Quantitative analysis.....	25
Standard preparation of strychnine and brucine solutions .....	25
Sample preparation by ethanol Soxhlet extraction.....	25
Thin layer chromatography .....	25
TLC image analysis by Image J software .....	25
TLC densitometry.....	26
Method validation .....	26
Specificity.....	26
Linearity and range.....	26
Accuracy.....	26
Precision .....	27
Limit of detection (LOD) .....	27
Limit of quantitation (LOQ).....	27
Robustness.....	27
DNA damage (Comet assay) .....	28
Isolated lymphocytes .....	28
Comet assay procedure.....	28
Data analysis .....	29
CHAPTER IV RESULTS.....	30
Macroscopic evaluation .....	30
Microscopic evaluation.....	32
Physico-chemical evaluation .....	34

	Page
Thin layer chromatographic fingerprint.....	35
Quantitative analysis of strychnine and brucine in <i>S. nux-vomica</i> seeds .....	36
Ethanolic extract of <i>S. nux-vomica</i> seeds .....	36
Specificity.....	37
TLC image analysis by Image J software.....	39
Method validation .....	39
Linearity and range.....	39
Accuracy.....	40
Precision .....	41
Detection limit and quantitation limit .....	41
Robustness.....	42
The contents of strychnine and brucine in <i>S. nux-vomica</i> seeds by TLC image analysis .....	43
TLC densitometry .....	44
Method validation.....	46
Linearity and range.....	46
Accuracy.....	47
Precision .....	48
Detection limit and quantitation limit .....	48
Robustness.....	49
The contents of strychnine and brucine in <i>S. nux-vomica</i> seeds by TLC densitometry .....	50
The comparison of strychnine and brucine contents using TLC image analysis and TLC densitometry .....	52
DNA damage in human lymphocyte cells .....	55
CHAPTER V DISCUSSION AND CONCLUSION .....	57
REFERENCES .....	61
APPENDIX A.....	69
APPENDIX B .....	72

	Page
APPENDIX C .....	96
VITA .....	102



## LIST OF TABLES

<b>Table 1</b> Family Strychnaceae in Thailand.....	5
<b>Table 2</b> Traditional uses of <i>S. nux-vomica</i> .....	7
<b>Table 3</b> Traditional uses of <i>S. nux-vomica</i> (cont.).....	8
<b>Table 4</b> Strychnine and brucine in <i>Strychnos</i> species .....	12
<b>Table 5</b> Physico-chemical specifications of <i>S. nux-vomica</i> seeds.....	34
<b>Table 6</b> Percent yield of <i>S. nux-vomica</i> seeds from 15 different sources in Thailand .....	36
<b>Table 7</b> Accuracy of quantitation of strychnine (n=3) in <i>S. nux-vomica</i> seeds by TLC image analysis .....	40
<b>Table 8</b> Accuracy of quantitation of brucine (n=3) in <i>S. nux-vomica</i> seeds by TLC image analysis.....	40
<b>Table 9</b> Repeatability and intermediate precision of quantitation of strychnine in <i>S. nux-vomica</i> seeds by TLC image analysis .....	41
<b>Table 10</b> Repeatability and intermediate precision of quantitation of brucine in <i>S. nux-vomica</i> seeds by TLC image analysis .....	41
<b>Table 11</b> Robustness of quantitation of strychnine in <i>S. nux-vomica</i> seeds by TLC image analysis.....	42
<b>Table 12</b> Robustness of quantitation of brucine in <i>S. nux-vomica</i> seeds by TLC image analysis.....	42
<b>Table 13</b> The content of strychnine in <i>S. nux-vomica</i> seeds in % by weight by TLC image analysis .....	43
<b>Table 14</b> The content of brucine in <i>S. nux-vomica</i> seeds in % by weight by TLC image analysis.....	44
<b>Table 15</b> Accuracy of quantitation of strychnine (n=3) in <i>S. nux-vomica</i> seeds by TLC densitometry .....	47
<b>Table 16</b> Accuracy of quantitation of brucine (n=3) in <i>S. nux-vomica</i> seeds by TLC densitometry .....	47
<b>Table 17</b> Repeatability and intermediate precision of quantitation of strychnine in <i>S. nux-vomica</i> seeds by TLC densitometry.....	48
<b>Table 18</b> Repeatability and intermediate precision of quantitation of brucine in <i>S. nux-vomica</i> seeds by TLC densitometry.....	48

<b>Table 19</b> Robustness of quantitation of strychnine in <i>S. nux-vomica</i> seeds by TLC densitometry.....	49
<b>Table 20</b> Robustness of quantitation of brucine in <i>S. nux-vomica</i> seeds by TLC densitometry.....	49
<b>Table 21</b> The content of strychnine in <i>S. nux-vomica</i> seeds in % by weight by TLC densitometry .....	50
<b>Table 22</b> The content of brucine in <i>S. nux-vomica</i> seeds in % by weight by TLC densitometry.....	51
<b>Table 23</b> Comparison of strychnine content between TLC image analysis and TLC densitometry .....	52
<b>Table 24</b> Comparison of brucine content between TLC image analysis and TLC densitometry.....	53
<b>Table 25</b> The sources of 15 plant samples used in the study .....	70
<b>Table 26</b> Physico-chemical properties of <i>Strychnos nux-vomica</i> dried seeds among 15 sources.....	71
<b>Table 27</b> The strychnine content in <i>S. nux-vomica</i> dried crude drug from 15 sources by TLC image analysis .....	73
<b>Table 28</b> The brucine content in <i>S. nux-vomica</i> dried crude drug from 15 sources by TLC image analysis .....	74
<b>Table 29</b> The strychnine content in <i>S. nux-vomica</i> dried crude drug from 15 sources by TLC densitometry .....	75
<b>Table 30</b> The brucine content in <i>S. nux-vomica</i> dried crude drug from 15 sources by TLC densitometry .....	76
<b>Table 31</b> The total scores of DNA damage between 0- 400 arbitrary unit of strychnine, brucine standard and <i>S. nux-vomica</i> seeds extract .....	97

## LIST OF FIGURES

<b>Figure 1</b> <i>S. nux-vomica</i> tree (a), flowers (b), leaves (c), fruit (d) and seeds (e).....	6
<b>Figure 2</b> Strychnine structure .....	10
<b>Figure 3</b> Brucine structure.....	11
<b>Figure 4</b> Azeotropic apparatus .....	23
<b>Figure 5</b> <i>S. nux-vomica</i> dried seeds.....	30
<b>Figure 6</b> Branch of <i>S. nux-vomica</i> Linn. (A) Fruit section (B) Seed .....	31
<b>Figure 7</b> Anatomical characters of cross sectional <i>S. nux-vomica</i> seed.....	32
<b>Figure 8</b> Histological characters of <i>S. nux-vomica</i> seed powders.....	33
<b>Figure 9</b> TLC fingerprint of <i>S. nux-vomica</i> seeds ethanolic extract .....	35
<b>Figure 10</b> Absorbance spectra of strychnine (A) and brucine (B) among standard and sample spots representing peak identity.....	37
<b>Figure 11</b> Absorbance spectra of strychnine (A) and brucine (B) among peak start, peak apex and peak end of sample spots representing peak purity.....	38
<b>Figure 12</b> The calibration curves of strychnine (A) and brucine (B) by TLC image analysis.....	39
<b>Figure 13</b> TLC densitograms of 15 samples and standard strychnine (A) and brucine (B) under 257 and 302 nm respectively .....	45
<b>Figure 14</b> The calibration curves of strychnine (A) and brucine (B) by TLC densitometry.....	46
<b>Figure 15</b> The linear graph comparisons for the analysis results of strychnine (A) and brucine (B) between densitometry and image analysis.....	54
<b>Figure 16</b> The total scores of DNA damage in human lymphocytes cells.....	55
<b>Figure 17</b> DNA damage in human lymphocytes cells .....	56
<b>Figure 18</b> TLC chromatograms of 15 samples and standard strychnine (A) under 254 nm, with invert and subtracts background by Image J software (B) .....	77
<b>Figure 19</b> TLC chromatograms of 15 samples and standard brucine (A) under 254 nm, with invert and subtracts background by Image J software (B) .....	78
<b>Figure 20</b> TLC chromatogram of strychnine standard No.1-5 by TLC image analysis by Image J software .....	79

<b>Figure 21</b> TLC chromatogram of sample No.1-5 by TLC image analysis by Image J software .....	80
<b>Figure 22</b> TLC chromatogram of sample No.6-10 by TLC image analysis by Image J software .....	81
<b>Figure 23</b> TLC chromatogram of sample No.11-15 by TLC image analysis by Image J software .....	82
<b>Figure 24</b> TLC chromatogram of brucine standard No.1-5 by TLC image analysis by Image J software .....	83
<b>Figure 25</b> TLC chromatogram of sample No.1-5 by TLC image analysis by Image J software .....	84
<b>Figure 26</b> TLC chromatogram of sample No.6-10 by TLC image analysis by Image J software .....	85
<b>Figure 27</b> TLC chromatogram of sample No.11-15 by TLC image analysis by Image J software .....	86
<b>Figure 28</b> TLC densitograms of 15 samples and standard strychnine (A) and brucine (B) under 257 and 302 nm respectively .....	87
<b>Figure 29</b> TLC densitogram of strychnine standard No.1-5 by TLC densitometry.....	88
<b>Figure 30</b> TLC densitogram of sample No.1-5 by TLC densitometry.....	89
<b>Figure 31</b> TLC densitogram of sample No.6-10 by TLC densitometry.....	90
<b>Figure 32</b> TLC densitogram of sample No.11-15 by TLC densitometry.....	91
<b>Figure 33</b> TLC densitogram of brucine standard No.1-5 by TLC densitometry ..	92
<b>Figure 34</b> TLC densitogram of sample No.1-5 by TLC densitometry.....	93
<b>Figure 35</b> TLC densitogram of sample No.6-10 by TLC densitometry.....	94
<b>Figure 36</b> TLC densitogram of sample No.11-15 by TLC densitometry.....	95
<b>Figure 37</b> The 100 images of DNA damaged in human lymphocyte cells by visual scoring under the magnification of 40 .....	98
<b>Figure 38</b> The 100 images of DNA damaged in human lymphocyte cells by visual scoring under the magnification of 400X (Cont.) .....	99
<b>Figure 39</b> The 100 images of DNA damaged in human lymphocyte cells by visual scoring under the magnification of 400X (Cont.) .....	100
<b>Figure 40</b> The 100 images of DNA damaged in human lymphocyte cells by visual scoring under the magnification of 400X (Cont.) .....	101

## LIST OF ABBREVIATIONS

%	Percent
°C	Degree Celcius
µg	Microgram
µl	Microliter
cm	Centimeter
g	Gram
g/cm	Gram per square meter
g/l	Gram per liter
g/mol	Gram per mole
ICH	International Conference on Harmonisation
kg	Kilogram
l	Liter
LOD	Limit of detection
LOQ	Limit of quantitation
m	Meter
mg	Miligram
mg/ml	Milligram per mililiter
min	Minute
ml	Milliter
nm	Nanometer
R <sup>2</sup>	Coefficient of determination
R <sub>f</sub>	Retention factor



RSD	Relative standard deviation
SCGE	Single cell gel electrophoresis
SD	Standard deviation
TLC	Thin layer chromatography
UV	Ultraviolet
v/v	Volume in a volume
WHO	World health organization



# CHAPTER I

## INTRODUCTION

### Background and rationale

Herbal medicines have been used in traditional Thai medicine for a long time. A various types of herbs have been used as medicine throughout the world. They have been used as a major part in all primary health care of traditional medicine system. Herbal medicines are easily accessible, available and inexpensive. In the present, the development of herbal medicines is necessary. The quality control and quality assurance indicate the quality of herbal materials. The quality of herbal medicines is interpreted in term of modern assessment and suitable techniques [1]. According to WHO (1998), the quality specifications of plant materials have been emphasized [2]. They are essential to establish internationally recognized guidelines for assessing their quality.

*Strychnos nux-vomica* has been used in ancient remedies of traditional Thai medicine [3], Ayurveda in India [4] and traditional Chinese medicine [5]. The seed of *S. nux-vomica* is called as “Kod-Ka-Kling” and has been used to treat the diseases such as central nervous system (CNS), numbness and paralysis [6]. Moreover, it has been used to relieve pain, promote blood circulation, alleviate blood stasis, and cure indigestion [5]. It has been used in combination with Kod-Kak-Kra (roots of *Anacyclus pyrethrum* (L.) DC.) and Kod-Num-Tao (rhizome of *Rheum palmatum* L.) as a Pikhad-Kodpisate remedy for the treatment of fever, oral cavity and oropharynx diseases, women’s menstrual blood, hemorrhoids and wound from insect bite [7].

However, the seed of *S. nux-vomica* contains two major alkaloids i.e. strychnine and brucine. Strychnine is the most alkaloid constituent of *S. nux-vomica* (40-50%) [8], it is well known as an arrow poison for hunting the animals [9]. This substance is highly toxic to humans and has been used as a self-poisoning [10, 11]. Brucine is the second most alkaloid constituent of *S. nux-vomica* (20-30%) [8]. These substances have been isolated since 18th century, and still used as powerful rodenticide [9, 12]. Nowadays, the selling of these compounds are forbidden.

The safety of herbal medicine is necessary especially for *S. nux-vomica* seed which is famous about the toxicity from strychnine and brucine constituents. The quantitative assay of these compounds is important to evaluate risk. Several techniques have been established for the examination of these compounds contents [4, 7-10]; among these, thin layer chromatography remains a commonly used technique for its simplicity and inexpensiveness. The genotoxic potential of *S. nux-vomica* seed and these two compounds are also revealed using Comet assay for DNA damage [11, 12].

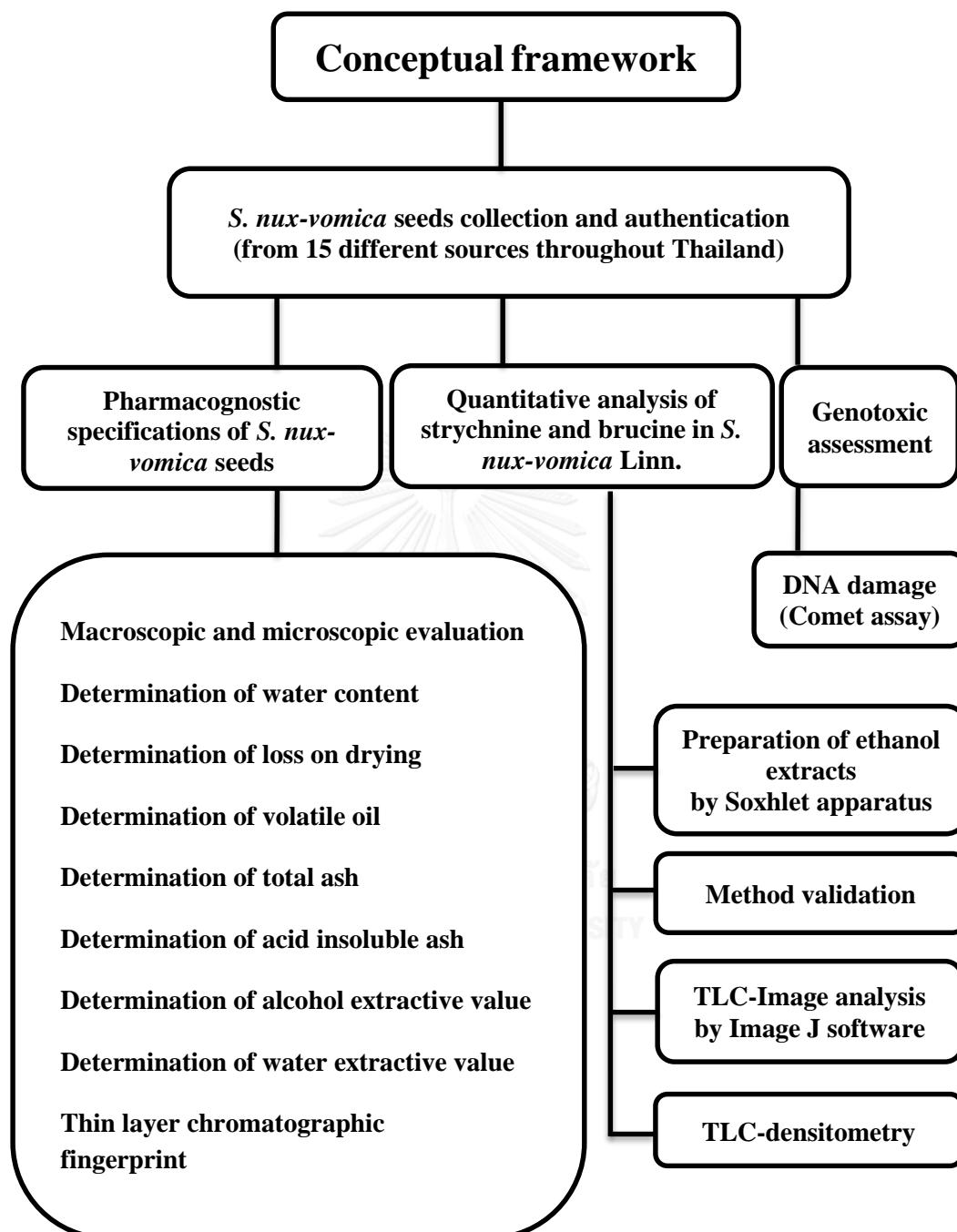
### **Research problems**

The pharmacognostic specification and strychnine, brucine quantities of *S. nux-vomica* seeds in Thailand have never been established.

### **Objectives**

1. To develop quality specification of *S. nux-vomica* seeds.
2. To examine the contents of strychnine and brucine in *S. nux-vomica* seeds.
3. To compare the quantitative method for strychnine and brucine between TLC image analysis by Image J software program and TLC densitometry.
4. To assess the toxic potential on DNA damage of *S. nux-vomica* seeds as well as strychnine and brucine.

## Conceptual framework



## CHAPTER II

### REVIEW LITERATURES

*STRYCHNOS*

Kingdom: Plantae

Subkingdom: Viridiaeplantae

Infrakingdom: Streptophyta

Division: Tracheophyta

Subdivision: Spermatophytina

Infradivision: Angiospermae

Class: Magnoliopsida

Superorder: Asteranae

Order: Gentianales

Family: Strychnaceae

Genus: *Strychnos*

Species: *Strychnos nux-vomica* Linn.

*Strychnos* is the only genus in Strychnaceae family found in Thailand. There are 11 species in Thailand [13, 14] as shown in Table 1.

**Table 1** Family Strychnaceae in Thailand

Genus	Species	Vernacular name
<i>Strychnos</i>	<i>Strychnos axillaris</i> Colebr.	Khwak kai
	<i>Strychnos ignatii</i> Berg	Phaya mue lek
	<i>Strychnos kerrii</i> A.W.Hill	Kluai khiao
	<i>Strychnos lucida</i> R.Br.	Phaya mun lek
	<i>Strychnos minor</i> Dennst.	Tumka khao/ Tumka daeng/ Phaya plong tong
	<i>Strychnos nitida</i> G.Don	Kluai khiao
	<i>Strychnos nux-blanda</i> A.W.Hill	Klo wo sae/ Tumka khao
	<i>Strychnos nux-vomica</i> Linn.	Kod ka kling/ Tumka daeng/ Wan fai ton/ Saleang jai/ Sa leang bear/ Saleang thon/ Kra jae
	<i>Strychnos rupicola</i> Pierre ex Dop.	Khi ka khrua
	<i>Strychnos thorelii</i> Pierre ex Dop	Khiao ngu
<i>Strychnos vanprukii</i> Craib	Thao chang	

***Strychnos nux-vomica* Linn.**

In latin, “strychnos” means “strychnon”, “nux” means “nut” and “vomica” means “lump” or “abcess”. Most people believe that “nux-vomica” means “no vomiting” or “stop vomiting” [15]. There are many names of *S. nux-vomica* as dog button, quaker button, poison nut, strychni [16].

**Ecology**

*S. nux-vomica* has grown wild in the forests of India and extensively in southern Asian countries [16]. This plant is a native plant in Indonesia, Sri Lanka, northern Australia, Thailand, Laos and Cambodia [17].

## Plant description

*S. nux-vomica* is a tree up to 25 m tall, and bole up to 100 cm in diameter, thick trunk or liana, branches not rough, yellowish-grey, axillary thorns; leaves thick and shiny dark green broadly elliptic 6 to 8 cm, 7.5 to 15 cm long; greenish-white bouquet flowers on short axillary branchlets with usually one pair of leaves, corolla 10-13 mm long, tube about 3 times longer than lobes, sparsely woolly hairy in lower half inside; fruit globose and smooth, 3 to 5 cm in diameter, orange peel when matured; seeds hard shell and lenticular shape, 1 to 4 seeded inside, orbicular to elliptical, light silvery-gray which cover with hairs, 1 to 3 cm in diameter, 4 to 6 mm thickness [18] as shown in the Figure 1.



**Figure 1** *S. nux-vomica* tree (a), flowers (b), leaves (c), fruit (d) and seeds (e)

## Traditional uses

*S. nux-vomica* seeds or Kod-Ka-Kling belongs to Phikhad-Kodpisate remedy in traditional Thai medical textbook. Phikhad-Kodpisate is a remedy including three herbal materials such as Kod-Ka-Kling, Kod-Kak-Kra (roots of *Anacyclus pyrethrum* (L.) DC.) and Kod-Num-Tao (rhizome of *Rheum palmatum* L.) which cure the respiratory tract disease, curing indigestion, women's menstrual blood, fever and reduce relating wound from insect bite [19]. Other traditional uses are shown in Table 2.

In Southeast Asia, the roots, stem bark and other parts of *S. nux-vomica* had been used to poison dart and arrow for hunting the animals [20]. The *Strychnos* genus in Asia and Africa were reputed as remedy for treatments of snakebites, fevers, ulcers, wounds, swellings, treatment leprosy, cholera and rabies [21]. For 400 years ago in Europe, this plants had been used to poison animals and rodents [17].

**Table 2** Traditional uses of *S. nux-vomica* [18, 19, 22]

Species	Medicinal use	Part of plant	
		Leaf	seed
<i>Strychnos nux-vomica</i> Linn.	Skin diseases	✓	
	Inflamed wound	✓	
	Anti-inflammatory activity		✓
	Analeptics		✓
	Increase the heart rate		✓
	Treat neurological diseases		✓
	Paralysis		✓
	Weakness		✓
	Numbness		✓



**Table 3** Traditional uses of *S. nux-vomica* (cont.)

Species	Medicinal use	Part of plant	
		Leaf	seed
<i>Strychnos nux-vomica</i> Linn.	Fever and bitter tonic		✓
	Central nervous system (CNS)		✓
	Sexual impotence(rejuvenation)		✓
	Dyspepsia		✓
	Worms and parasites		✓
	Diseases of the urinary system		✓
	Snakebite		✓
	Nausea		✓
	Analgesic		✓

### Pharmacological investigations

*S. nux-vomica* has been reputed as poisonous drugs for a long time [23, 24]. All parts of this plant are toxic which also known in the name of “poison nut tree”. Many researchers have reported the compounds in *S. nux-vomica* seeds that major alkaloid components are strychnine, strychnine *N*-oxide, brucine and brucine *N*-oxide [7, 17, 25]. Strychnine and brucine are importantly poisonous compounds in *S. nux-vomica* seed. Strychnine and brucine were found in pulp, seed coat and endosperm especially in endosperm [4].

### **Intoxication**

The substances of *S. nux-vomica* seeds were used as medicinal and poisonous drug. At dose 1-3 mg, strychnine causes tension in muscle, spinal reflex. If received 5-10 mg, the spinal reflex will increase suddenly and immobile muscle. Higher doses causes reflection of tonic convulsion, dyspnea, hyperthermia, rhabdomyolysis and finally paralysis [26, 27].

### **Detoxification**

Traditional detoxification of *S. nux-vomica* seeds is performed by parching with sea sands until dark yellow and then boiled with water [8, 28]. Parching of *S. nux-vomica* seeds resulted in the LD<sub>50</sub> of 2.18 - 2.57 mg/kg whereas unprocessed seeds showed LD<sub>50</sub> of 1.21 mg/kg in animal experiments [7]. According to Akbar (2010), strychnine content was lowest after immerse *S. nux-vomica* seeds in water for 5 days and cow milk for 2 days, washed with water and boiled in milk until the seed coat become soft [29].

### **Cytotoxicity**

The study in *S. nux-vomica* seeds about anti-tumor on human hepatoma cell line (HepG2) were found that strychnine also demonstrated significant inhibitory effects on HepG2 cell growth and brucine caused HepG2 cell shrinkage and dead of cell line *via* apoptosis [30].

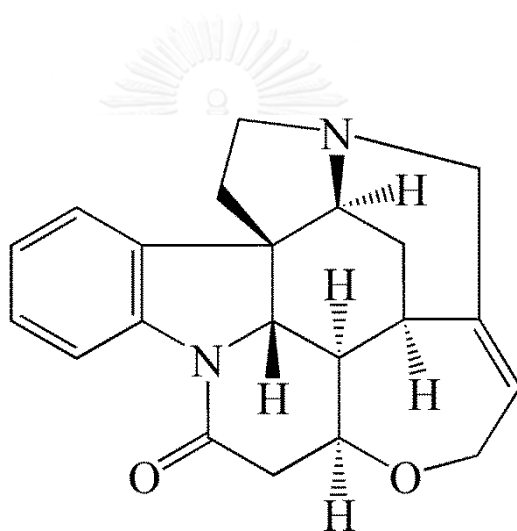
### **Anti-inflammatory**

The study of anti-inflammatory activity from seeds of *S. nux-vomica* found that brucine inhibited the release of prostaglandin E2 in inflammatory tissue and decrease acetic acid-induced vascular permeability [31].

## Chemical compounds

The major phytochemical compounds in *S. nux-vomica* are alkaloids especially strychnine and brucine. They are a monoterpene indole alkaloid which contain nitrogen as a heterocyclic ring. The contents of strychnine and brucine were reported to be 40-50% and 20-30% respectively [31-33]. The other alkaloids were reported such as stryvmicine, stryvomitine, isopseudostrychnine, 5-oxobrucine, 5-oxopseudostrychnine, 11-hydroxyl-icajine, 10-hydroxyl-icajine, 5-hydroxyl-vomicine [34].

## Strychnine



**Figure 2** Strychnine structure

Chemical (IUPAC) name: Strychnidin-10-one

Molecular Formula:  $C_{21}H_{22}N_2O_2$

Molecular weight: 334.40 g/mol C 75.42%, H 6.63%, N 8.38%, O 9.57%

Boiling point: 270 °C

Melting point: 268-290 °C (depending on the speed of heating)

Density: 1.36 g/cm

pH of saturated solution: 9.5

UV maximum absorption: 254, 278, 288 nm

Bitterness threshold: 1: 130,000

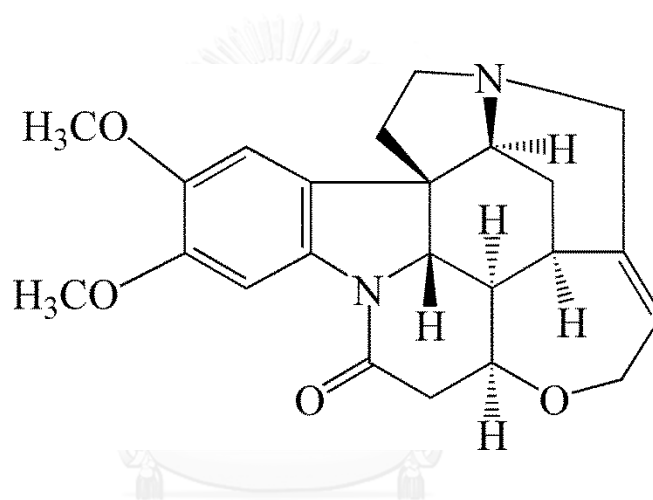
Strychnine is a bitter, white, crystal powder and very slightly soluble in ether, petroleum ether. One gram of strychnine dissolves in 6400 ml water, 3100 ml boiling water, 150 ml alcohol, 35 ml boiling alcohol, 5 ml chloroform, 180 ml benzene, about 200 ml toluene, 260 ml methanol, 320 ml glycerol, 220 ml amyl alcohol.

Caution: Extremely poisonous as antidote give short acting barbiturate.

Use: Strychnine and its salts found to destroy rodents and predatory animals and for trapping fur-bearing animals.

Therapy cautions: Has been used as a tonic and stimulant [35].

### Brucine



**Figure 3** Brucine structure

Chemical (IUPAC) name: 2, 3 Dimethoxystrychnidin-10-one, 10, 11-Dimethoxystrychnine

Molecular formula:  $C_{23}H_{26}N_2O_4$

Molecular weight: 394.45 g/mol C 70.02%, H 6.64%, N 7.10%, O 16.22%

Boiling point: 633.7 °C at 760 mmHg

Melting point: 178 °C

pH of saturated solution: 9.5

UV maximum absorption: 263, 301 nm

Bitterness threshold: 1: 220,000

Tetrahydrate, monoclinic prisms, also forms a dihydrate and very bitter test. Very poisonous becomes anhydrous at 100 °C. One gram of brucine dissolves in 0.8 ml methanol, 1.3 ml alcohol, 5 ml chloroform, 25 ml ethyl acetate, 36 ml glycerol, about 100 ml benzene, 187 ml ether, 1320 ml water, 750 ml boiling water.

Human Toxicity: A highly toxic alkaloid resembling strychnine.

Use: Denaturing alcohol and oils; in analytical chemistry; for separating racemic mixtures has been patented as addition agent to lubricants.

Therapy cautions: Central stimulant [35]

### Strychnine and brucine in *Strychnos* species

These two alkaloids are commonly found in *Strychnos* spp. (Table 3) [36-38].

**Table 4** Strychnine and brucine in *Strychnos* species

<i>Strychnos</i> spp.	Compounds		Part of plants
	Strychnine	Brucine	
<i>Strychnos nux-vomica</i> Linn.	✓	✓	All part
<i>Strychnos ignatii</i> Berg.	✓	✓	Seeds
<i>Strychnos tieute</i> Lesch.	✓	trace	Seeds
<i>Strychnos ligustrina</i> B.L.	✓	✓	Stem and wood
<i>Strychnos rheedei</i> C.B. Clarke	✓	✓	Seeds
<i>Strychnos aculeate</i> Soler.	-	✓	Seeds
<i>Strychnos truokubervua</i>	✓	✓	Seeds
<i>Strychnos nux-blanda</i> A.W.Hill	✓	✓	-
<i>Strychnos potatorum</i> Linn.	✓	✓	-
<i>Strychnos icaja</i> Baill.	✓	-	Root

### **Quality specifications of herbal material**

Pharmacognostic specifications are the guidance for establishing and ensuring the quality of medicinal plant materials. The specifications are performed using modern analytical techniques to define the physico-chemical properties of herbal materials [2]. The basic quality parameters include organoleptic characteristics, cellular structures, organic and inorganic components, moisture or water content in herbal materials [1, 39].

### **Authentication**

The authentication of herbal materials are ensured by professional herbalist or comparison with authentic specimen at the herbarium center for example the Department of Forestry, Bangkok, Thailand and the center of Plant Genetic Conservation Project Under the Royal Initiation of Her Royal Highness Princess Maha Chakri Sirindhorn (RSPG), Dusit, Bangkok, Thailand [1, 13, 40, 41].

### **Foreign matter**

The foreign matters such as soil, stones, sand and dust which adhered in herbal materials; fragments of the other plant materials and deteriorated, discolored plant material must be removed before any testing is performed [2, 40].

### **Macroscopic and microscopic evaluation**

Macroscopic evaluation of herbal materials is to examine the degree of purity which identified by shape, size, color, surface, texture and fracture. Microscopic inspection is necessary for identification of powdered materials and tissues on the surface view [1, 2, 40].

### **Determination of moisture content**

The insufficient drying of crude drug causes spoilage by molds and bacteria. The drying process is important to reduce the moisture content. The azeotropic volumetric method is more specific for evaluation of the water content. This technique is to separate water in the sample under heat with water immiscible solvent such as toluene, xylene and carbon tetrachloride. The method is certainly appropriate for crude drugs but the disadvantage is due to a large sample requirement [1, 2, 40].

### **Determination of loss on drying**

The loss on drying is gravimetric method to quantify the weight loss after heating which represents not only water but also any volatile matters. The crude drugs are weighed for the weight loss by drying at 100 - 105 °C until constant weight ( $\pm 5$  mg). Alternatively, drying agent such as phosphorus pentoxide can be used; by this technique, only water loss is obtained [1, 2, 40].

### **Determination of volatile oil**

The characteristics of volatile oils is recognized by their odour, oil-like appearance and ability to volatilize at room temperature. They are various chemical components, for example monoterpenes, sesquiterpenes and their oxygenated derivatives. Aromatic compounds predominate in certain volatile oils. They are considered to be the “essence” of the herbal material, and are often biologically active, they are also known as “essential oils”. The determination of volatile oils is carried out by steam/hydro distillation.

### **Determination of total ash and acid insoluble ash**

The inorganic matters of the crude drug are measured by incineration at 500 - 600 °C until the absence of organic carbon compound. The total ash contains inorganic elements and their salts such as carbonates, phosphates, silicates. The acid insoluble ash is the residue remained after the total ash is boiling with 70 g/l of hydrochloric acid. This type of ash represents some inorganic elements including silica [2, 40].

### **Determination of solvent extractive value**

The extractable content of crude drug represents the amount of active constituents. The particular solvent gives a different phyto-constituent extraction depending on the physico-chemical property of each compound. Water and ethanol are used as elementary solvents for crude drug extraction [1, 39].

### **Quantitative analysis**

#### **Chromatographic analysis**

Many chromatographic techniques are used for quantification of alkaloids in *S. nux-vomica* such as liquid chromatography (LC), high performance liquid chromatography (HPLC), gas chromatography (GC), thin layer chromatography (TLC), and high performance thin layer chromatography (HPTLC) [4, 8, 9, 42, 43].

#### **Thin layer chromatography (TLC)**

TLC is a physicochemical separation method which identifies and investigates the phytochemical compounds. This technique is usually used to evaluate the chemical compounds in herbal materials. The process of an analysis includes the sorbents as stationary phase and solvent system as mobile phase. Stationary phase is common absorbent such as silica gel, aluminum oxide, kieselguhr, cellulose and derivatives which coated on a glass, plastic or aluminium plate. Stationary phase with fluorescent indicator (F<sub>254</sub>) is favorite. Mobile phase contains one or a mixture of solvents with specified ratio. The development distance of compounds is calculated for the hRf value [44-46].

$$\text{hRf} = \frac{\text{distance of spot center from start}}{\text{distance of solvent front from start}} \times 100$$



### **Detection of compounds**

The UV-lamps are usually used for detection of a colorless compounds. The aromatic compounds will absorb or quenching short wavelength UV (254 nm), the dark spots on a green-yellow fluorescent background will appear. Some compounds can fluoresce under long wavelength UV (365 nm). Various developing reagents can be used for detection of various types of compounds [44]. For alkaloids, Dragendorff's reagent which consists of bismuth nitrate, nitric acid and potassium iodide is commonly used and gives the orange color. Acidified ceric ammonium sulfate reagent is more specific to indole alkaloid and gives the yellow color [45].

### **TLC-densitometry**

Densitometry is a method to measure the optical density of light reflection. TLC densitometer or TLC scanner is used to measure the absorbance and/or fluorescence provided by individual spots of materials. The intensity of monochromatic light is proportional to the amount of compound and represented as peak area.

### **TLC-Image J software program**

The Image J software is one of image analysis programs which is a public domain Java image processing available for online downloadable application. The data processing functions of Image J program are used to calculate pixel intensity and a given area of the image and represented as peak area.

Image J software is adapted for assessment of quantitative TLC analysis. The TLC plate is photographed by digital camera and should be saved as TIFF file. This program supports for Windows, Mac OSX and Linux. The free software can link to external URLs, such as the Image J website, <http://imagej.nih.gov/ij/> [47].

## **Method validation**

According to the ICH guideline, any developed analytical procedures for quantitative tests of materials must be validated. The method validation consists of specificity, linearity, accuracy, precision, limit of detection, limit of quantitation and robustness [2].

### **Specificity**

Specificity is the ability to assess the presence of the analyte that expected to be present. In chromatographic procedure, the peak identification should be demonstrated on the discrimination of interested compound and other compounds in the sample. Moreover, the peak of standard and interested compound should be matched by the UV absorbance spectra. The peak purity is performed to ensure the impurities of UV absorbance spectra which assess by peak start, peak apex and peak end of one component.

### **Range and linearity**

The range is the interval between the upper and lower concentration of analyte in the sample which suitable to demonstrate for level of precision, accuracy and linearity. The linearity of analytical method is its ability to obtain test results within a given range directly proportional concentration of analyte in the sample. The ICH guideline is recommended that 5 concentrations to establish linearity.

### **Accuracy**

The accuracy of an analytical method is express the closeness between the accepted value, true value or an accepted reference value and the value found. The accuracy should be established across the specified range of the analytical procedure and to assess using a minimum of 9 determinations (3 concentrations/ 3 replicates) over a minimum of levels covering the specified range in the total analytical procedure. Accuracy should be reported as percent recovery, three differences concentration (3 replicates) which known amount added are prepared to spike into the sample.

## Precision

The precision of an analytical method is expressed the closeness of agreement between a series of measurements which obtained from multiple sampling of the same homogeneous sample under the prescribed conditions. The analytical procedure is considered at three level; repeatability, intermediate precision and reproducibility. According to ICH guideline, the percent relative standard deviation is recommended for each type of precision investigated.

## Limit of detection (LOD)

LOD is the lowest amount of analyte in a sample that can be detected based on visual evaluation, signal-to-noise ratio or standard deviation of the response and the slope. It is also influence to the matrix. The signal-to-noise ratio can be determined between 3 or 2:1 that is generally considered acceptable for estimating the detection limit. The standard deviation of the blank, regression line or y-intercepts of regression line can be accepted to determine. LOD expressed as slope of calibration curve estimated S and the standard deviation SD following formula.

$$\text{LOD} = \frac{3.3 (\text{SD})}{S}$$

## Limit of quantitation (LOQ)

LOQ is the lowest amount of analyte in a sample that can be quantitatively determined with suitable precision and accuracy. The low level of compounds in sample matrices that particularly for determination of impurities or degradation products. LOQ is based on visual evaluation, signal-to-noise ratio or standard deviation of the response and the slope. The minimum concentration of signal-to-noise can be reliably quantified as 10:1 for establishing the quantification. The standard deviation of the blank, regression line or y-intercepts of regression line can be accepted to determine. LOQ expressed as slope of calibration curve estimated S and standard deviation SD following formula.

$$\text{LOQ} = \frac{10 (\text{SD})}{S}$$

## **Robustness**

The robustness is an analytical procedure which depend on the type of procedure under study. It shows the reliability of small deliberate variations in method parameters [4].

## **Genotoxicity**

There are many endogenous and exogenous factors that cause DNA damage. Some substances affect to the genetic information in organism which causing cell mutations [48, 49]. The poisonous substances such as strychnine and brucine may lead to a neurotoxicity or lead to mutagenesis. The chemicals affect to post-synaptic inhibitory neurons, and increase the level of neuronal excitability in central nervous system [24, 25, 50]. The assessment of Ames test, toxicology tests and comet assay may indicate the potential of genotoxicity. Comet assay was applied in several plants studies to establish the DNA-damage potential [51-53].

## **Comet assay**

Single cell gel electrophoresis (SCGE) or comet assay has become one of the standard methods for assessing DNA damage. The assay is simple, sensitive and versatile for detecting DNA single-strand breaks, double-strand breaks, alkali-labile sites, and cross-linking in eukaryotic cells. The single cell suspension can be obtained as cells isolated from blood, cells from tissue biopsies, buccal cells, whole blood, cultured cells and moreover plant cells and sperm cells [11, 12].

The method investigates fragments of DNA (damaged DNA) that illustrated as a tail of comet. The basic steps of the assay include (1) preparation of slides that cells embedded in agarose; (2) lysis of cells to remove cellular membrane, cytoplasmic and nucleoplasmic constituents, histones and to remain the nucleoid; (3) alkaline unwinding ( $\text{pH} > 13$ ) to express alkali labile site and to reveal the break of single stranded DNA; (4) electrophoresis under alkaline solution ( $\text{pH} > 13$ ) to detect the migration of DNA fragments; (5) neutralization of alkali; (6) DNA staining and comet visualization; (7) comet scoring [54-57].

## CHAPTER III

### MATERIALS AND METHODOLOGY

#### Chemicals and reagents

Acetic acid	Glacial grade, BDH chemicals Ltd, Poole, English
Bismuthyl nitrate	98%, Sigma-Aldrich, St. Louis, MO, USA
Brucine	Anhydrous 98%, Sigma-Aldrich, St. Louis, MO, USA
Diethyl amine	A.R. grade, RCI Labscan Limited, Bangkok, Thailand
Ethanol	A.R. grade, RCI Labscan Limited, Bangkok, Thailand
Ethyl acetate	A.R. grade, RCI Labscan Limited, Bangkok, Thailand
Hydrochloric acid	A.R. grade, RCI Labscan Limited, Bangkok, Thailand
Potassium iodide	BDH laboratory reagent, England
Strychnine	Isolation by Assoc. Prof. Nijisiri ruangrunsi, Ph.D., Chulalongkorn University
Toluene	A.R. grade, RCI Labscan Limited, Bangkok, Thailand
Water	Reverse osmosis purifying system (RO), Water quality association, USA

#### Materials

Cover glasses	Menzel-Glaser, Germany
Filter-paper No.4	WhatmanTM, UK
Filter-paper No.40 ashless	WhatmanTM, UK
Microscope slide	Sail Brand, China
TLC plate	Aluminium sheets, Silica gel 60 GF254, 0.2 mm thickness, Merck, Darmstadt, Germany

**Instrumentations**

Air-displacement micropipette	Brand Tech Scientific, Inc., Germany
Autometric shaker	WiseShake, Wisd. Laboratory instruments
Azeotropic apparatus	
Clevenger apparatus	
Densitometer	TLC Scanner 4, CAMAG, Lambda Scientific Co., Ltd., Switzerland
Digital camera	Canon Power Shot A650 IS, Canon Marketing, Thailand
Hot air over	WTC Binder, Germany
Image J software	Version: 1.47, Java 1.6.0_20 32-bit, National Institutes of Health, USA
Microscope	Carl Zeiss model Axio Lab, Germany
Rotary evaporator	Buchi labortechnik AG, Switzerland
Shaker	Adolf Kuhner AG, Saitzerland
Soxhlet apparatus	CAMAG, Switzerland
Syringe	SGE Analytical Science, Australia
TLC chamber	CAMAG, Switzerland
TLC visualizer	CAMAG, Switzerland
UV cabinet	Spectroline Model CC-80, Spectronics corporation, PG Instruments Limited, UK
Water bath	Brinkman, USA
WinCATS software	Version: 1.4.6.2002, CAMAG, Switzerland

## **Research methodology**

*Strychnos nux-vomica* seeds were categorized morphology from macroscopic and microscopic evaluation. The standardization was covered the determination of water content, loss on drying, total ash, acid insoluble ash, alcohol and water extractive values. Pharmacognostic specification was establishing quality standards, ensuing emphasis of medicinal plant materials and using modern control techniques follow by World Health Organization (WHO) Guideline and validate the method specification, linearity, range, limit of detection, limit of quantitation, accuracy, precision and robustness follow by ICH Harmonized Tripartite Guideline.

## **Sample collections**

The samples of *S. nux-vomica* seeds were collected from 15 sources throughout Thailand. The samples were authenticated by Assoc. Prof. Dr. Nijsiri Ruangrunsi. The foreign matters were removed. The voucher specimen were kept at College of Public Health Sciences, Chulalongkorn University.

## **Macroscopic evaluation**

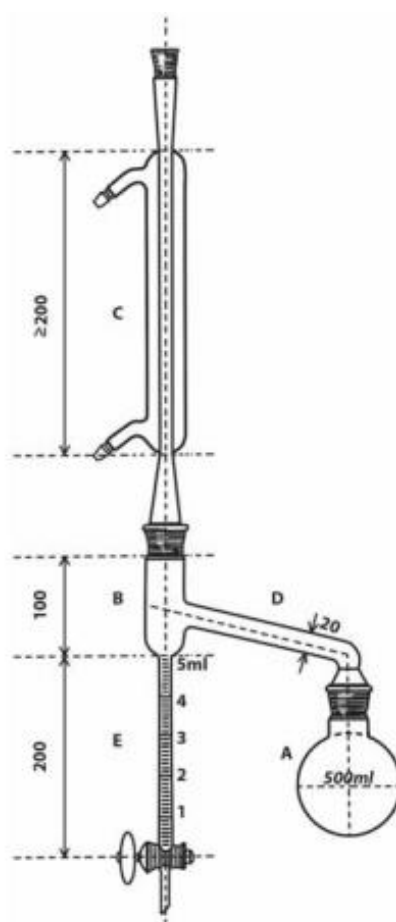
*S. nux-vomica* seeds were characterized by visual evaluation including shape, size, surface, color, texture, fracture, smell and taste.

## **Microscopic evaluation**

The powders and cross sections of *S. nux-vomica* seeds were examined under microscopic evaluation. They were put on glass slide and covered with water then observed *via* the microscope coupled with the digital camera under specified magnifications. Line drawings of the histological and anatomical characters were illustrate.

**Determination of water content (Azeotropic distillation method)**

Fifty grams of the powders of *S. nux-vomica* seeds were added with 200 ml of water-saturated toluene in round bottom flask (A) connected by tube (D) to a cylindrical tube (B) which connecting to a reflux condenser (C). Water distilled was dislodged from receiving tube (E). The separate layers of water and toluene in receiving tube was transferred, allow to cool in room temperature and calculated the content in percentage.



**Figure 4** Azeotropic apparatus [2]



### **Determination of loss on drying, total ash and acid insoluble ash**

Three grams of the powders of *S. nux-vomica* seeds in the pre-weighed crucibles were dried at 105 °C in an oven until constant weight and rest in a desiccator until cool down. Loss of weight on drying was recorded in percentage. Then the crucibles were incinerated at 500 °C until white (absence of carbon). The total ash was weighed and recorded in percentage. Twenty-five ml of hydrochloric acid solution (70 g/l) was added in the crucible and boiled gently for 5 minutes. The insoluble matters were filtered through the ashless filter-paper (No.40) and washed with hot water until the filtrate are neutral. The filter-papers containing insoluble matters were transferred to the original crucibles, dried on a hotplate and incinerated again. The acid insoluble ash was weighed and recorded in percentage.

### **Determination of ethanol soluble extractive value**

Five grams of the powders of *S. nux-vomica seeds* in a conical flasks were macerated with 70 ml of 95% ethanol under shaking for 6 hours and standing for 18 hours respectively. After filtration, the marc was washed and adjusted the final volume to 100 ml. The portions of 20 ml were transferred to a pre-weighed beakers, evaporated to dryness on water-bath, dried at 105 °C for 6 hours, cooled in a desiccator until constant weight and weighed. The extractive value was recorded in percentage.

### **Determination of water soluble extractive value**

Five grams of the crush powders of *S. nux-vomica seeds* in a conical flasks were macerated with 70 ml of water under shaking for 6 hours and standing for 18 hours respectively. After filtration, the marc was washed and adjusted the final volume to 100 ml. The portions of 20 ml were transferred to a pre-weighed beakers, evaporated to dryness on water-bath, dried at 105 °C for 6 hours, cooled in a desiccator until constant weight and weighed. The extractive value was recorded in percentage.

### **Thin layer chromatographic fingerprint**

Another portion of 20 ml from part of ethanol soluble extractive value was transferred to a beaker, evaporated to dryness and re-dissolved in 1 ml of ethanol. Three microliters of this ethanolic extract was spotted on stationary phase of silica gel GF<sub>254</sub> TLC plate and developed in the chamber saturated with mobile phase of toluene: ethyl acetate: diethyl amine (7: 2: 1). The spots were observed under UV at 254 and 365 nm as well as suitable developing reagent. The Dragendorff's reagent was stained for alkaloid detection.

### **Quantitative analysis**

#### **Standard preparation of strychnine and brucine solutions**

The standard solutions were prepared to the concentration of 0.08, 0.16, 0.24, 0.32 and 0.4 mg/ml for strychnine and 0.04, 0.08, 0.12, 0.16 and 0.2 mg/ml for brucine. These standard solutions were stored at 5 °C.

#### **Sample preparation by ethanol Soxhlet extraction**

Five grams of the powders of *S. nux-vomica* seeds were extracted with 250 ml of 95% ethanol by Soxhlet apparatus until exhaustion. The extracts were filtered through the filter-paper No.4, evaporated to dryness and weighed. The extract solutions of 2 mg/ml and 2.5 mg/ml were prepared in ethanol for strychnine and brucine analyses respectively.

### **Thin layer chromatography**

Five microliters of standard and sample solutions in ethanol were applied on stationary phase of silica gel GF<sub>254</sub> TLC plate. TLC chamber was saturated with toluene: ethyl acetate: diethyl amine (7: 2: 1) for 1 hour before developing the plate.

#### **TLC image analysis by Image J software**

The spots on TLC plate was photographed under UV at 254 nm with digital camera and saved as TIFF file. The photograph was inverted and subtract background

by TLC image J program. The contrast of spots and background were performed the peak area.

### **TLC densitometry**

The developed TLC plate was scanned under UV at 257 and 302 nm which are the maximum absorption wavelengths of strychnine and brucine, respectively.

### **Method validation**

The method validation including specificity, linearity, accuracy, precision, limit of detection, limit of quantitation and robustness were performed according to the ICH guideline [58].

### **Specificity**

The spots of standards and samples on TLC plate were scanned at 200 - 500 nm for peak identity checking. The peak purity was checked at peak start, peak apex and peak end.

### **Linearity and range**

The calibration range of strychnine and brucine were plotted with peak area *versus* concentrations of standards. The regression line and coefficient of calibration curves were established by trendline options of Microsoft excel 2013.

### **Accuracy**

The accuracy was determined as % recovery of three standard levels (low, medium and high) spiking into the sample (n=3) that calculated following the formula.

$$\% \text{ Recovery} = \left\{ \frac{C1}{(C2 + C3)} \right\} \times 100$$

Where;

C1= actual calculated amount in recovery sample

C2=Amount spiked into the recovery sample

C3=Calculated theoretical pre-existing amount

### **Precision**

The precision of low, medium and high levels of analytes were examined (n=3) by the same day (repeatability) and different days (intermediate precision) and expressed in term of percent relative standard deviation (% RSD) by following the formula.

$$\% \text{ RSD} = \left( \frac{\text{SD} \times 100}{\text{Mean}} \right)$$

### **Limit of detection (LOD)**

LOD was estimated from calibration curve based on standard deviation of regression lines (SD) and the slope (S) following the formula.

$$\text{LOD} = \frac{3.3 (\text{SD})}{S}$$

### **Limit of quantitation (LOQ)**

LOQ was estimated from calibration curve based on standard deviation of regression lines (SD) and the slope (S) following the formula.

$$\text{LOQ} = \frac{10 (\text{SD})}{S}$$

### **Robustness**

The method was tested for the small changes in the mobile phase. The solvent compositions were changed in the ratio of toluene, ethyl acetate, diethyl amine as 7: 2: 1, 6: 3: 1 and 8: 1: 1. Each test was performed in triplicate (n=3). The robustness was examined in terms of % RSD.

## **DNA damage (Comet assay)**

### **Isolated lymphocytes**

Fresh blood specimen was aseptically collected in heparinized sterile tube from healthy donor. Six microliters of diluted fresh blood was added into a conical centrifuge tube which contained 3 ml of Ficoll-Histopaque 1077, centrifuge at 1,800 rpm, 4 °C for 30 minutes. The lymphocyte cells were washed three times by transferring them into the phosphate buffer saline pH 7.4, centrifuge at 1,600 rpm, 4 °C for 10 minutes. Five milliliters of RPMI 1640 (incomplete medium) was added, and centrifuge to discharge the buffer. RPMI 1640 (complete medium) was added to obtain the lymphocyte suspension about  $4 \times 10^5$  cells/ml. Four hundred microliters portions were aliquoted into microcentrifuge tube and kept them at -80°C.

### **Comet assay procedure**

The human lymphocyte cells were placed in an ice bath then washed with PBS buffer pH 7.4, and RPMI 1640 (incomplete medium) was added as suspension. Strychnine and brucine standards, *S. nux-vomica* seeds extracted at three concentrations of 25, 50 and 100 µg/ml were dissolved in 2% DMSO. The PBS buffer pH 7.4 and 30 % hydrogen peroxide (H<sub>2</sub>O<sub>2</sub>) were used as a negative and positive control. One hundred microliters of suspension and 100 µl of sample were mixed, incubated at 37 °C for 1 hour. The treated samples were centrifuged to discharge the supernatant at 3,000 rpm, 4 °C for 5 minutes.

At first layer, the slide was pre-coated by dipping into 1% normal agarose which melt in water, cleaned one side, labeled and kept in a low-humidity or desiccant before use to ensure the agarose adhesion. The treated samples and 1% of low melt agarose which melt with PBS buffer pH 7.4 were mixed as ratio 1:1 at 37 °C, and then spread it onto the second layer, cover with coverslip, keep on ice packs until agarose gel harden. Slide off coverslip and spread 0.5% of low melt agarose which melt with PBS buffer pH 7.4 onto a third layer, cover with coverslip until agarose forming and kept in a cool temperature. Slide off coverslip and immerse the slides into a cool freshly lysis solution (2.5 M NaCl, 100 mM EDTA, 10 mM Tris, 10% DMSO and 1% Triton X-100) for 1 hour. After lysis process, the slides were transferred to place in horizontal

gel electrophoresis chamber which contained the alkaline unwinding (1 mM Na<sub>2</sub>EDTA and 300 mM NaOH, pH > 13) for 25 minutes. The electrophoresis was conducted at 0.7 v/cm for 25 minutes. After that, the neutralization buffer containing 0.4 M Tris buffer pH 7.5 was rinsed three times for 5 minutes.

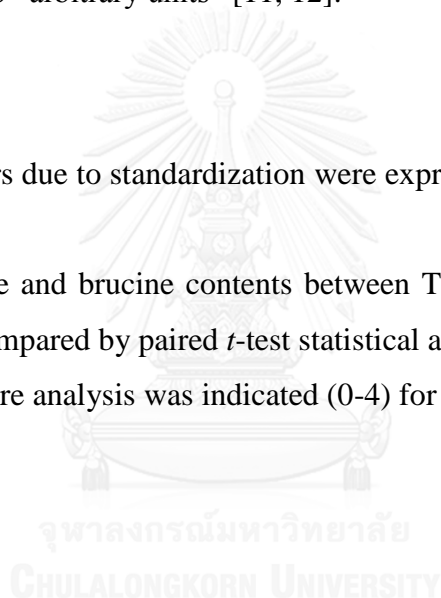
The slides were placed to stain of 20 µg/ml Ethidium bromide for 5 minutes, rinse with water and cover with coverslip, keep on ice pack. The fluorescent microscope was observed the migrated DNA (comet) images under the magnification of 400X. The degree of damage was classified by five classes of visual scoring, 0 (no tail) to 4 (almost all DNA in tail). One hundred comets per slide was scored to assign a value between 0 – 400 “arbitrary units” [11, 12].

### **Data analysis**

The parameters due to standardization were expressed as grand mean ± pooled standard deviation.

The strychnine and brucine contents between TLC image analysis and TLC-densitometry were compared by paired *t*-test statistical analysis.

The visual score analysis was indicated (0-4) for five classes of DNA damage.



## CHAPTER IV

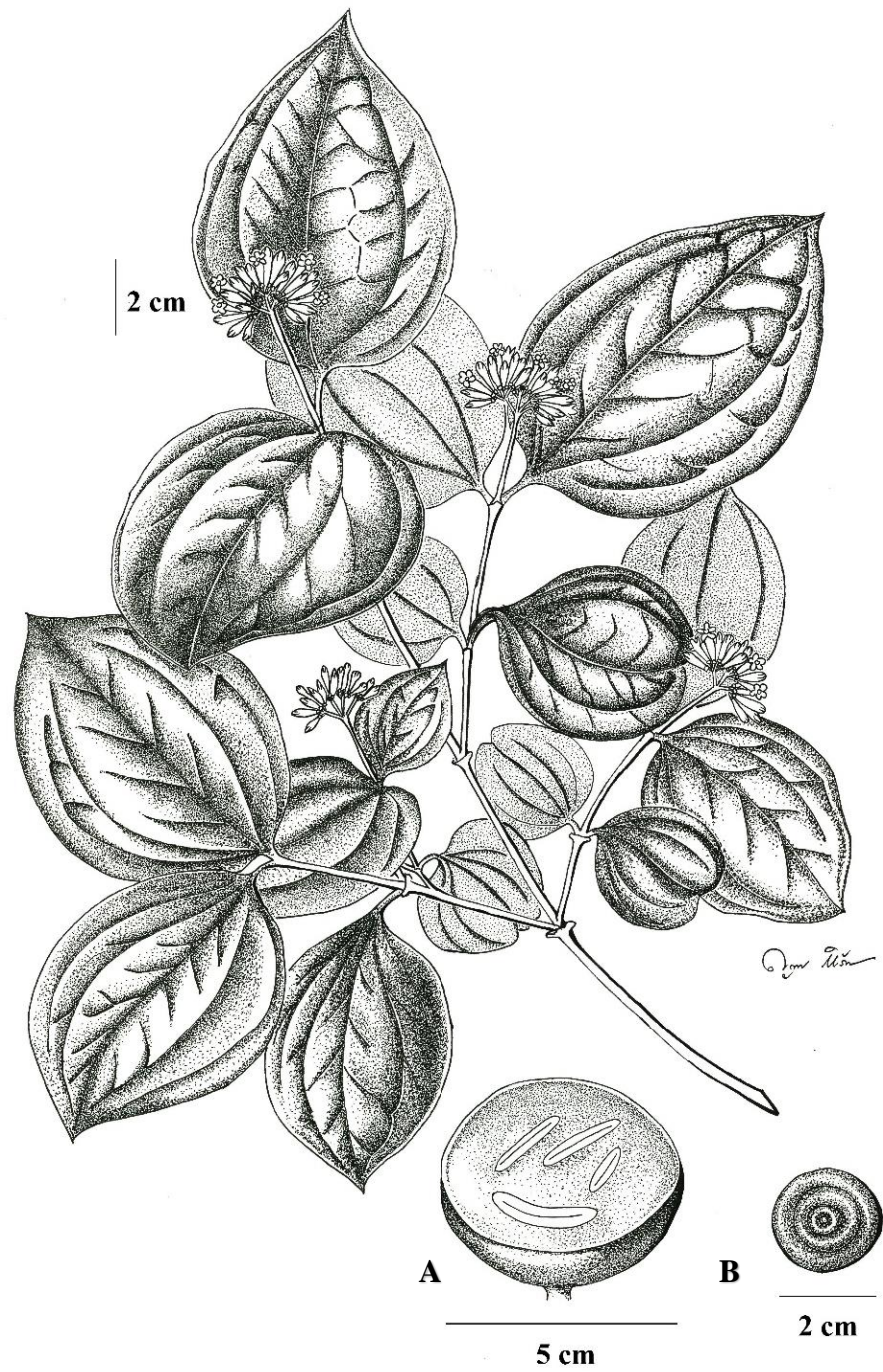
### RESULTS

#### Macroscopic evaluation

The dried seeds of *Strychnos nux-vomica* were hard shell and dish shape, rounded surfaces, odorless and very bitter taste, light silvery-gray, covered with hairs, 2-3 cm in diameter and 4-6 mm in thickness as shown in Figure 6. The branch of *S. nux-vomica* was shown in Figure 7.



**Figure 5** *S. nux-vomica* dried seeds

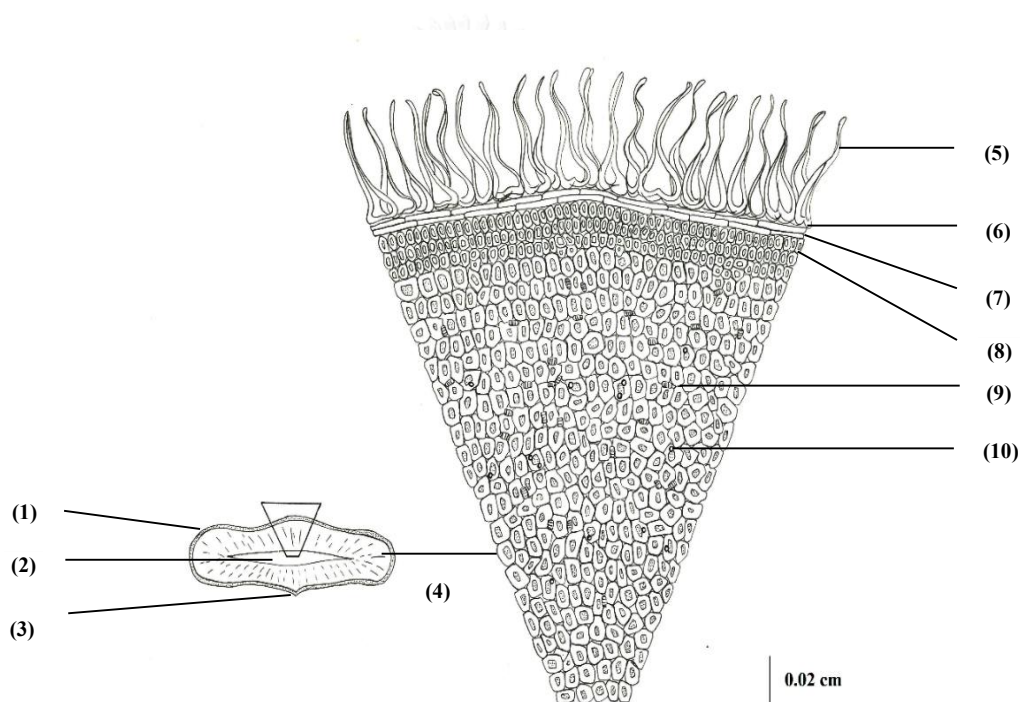


**Figure 6** Branch of *S. nux-vomica* Linn. (A) Fruit section (B) Seed



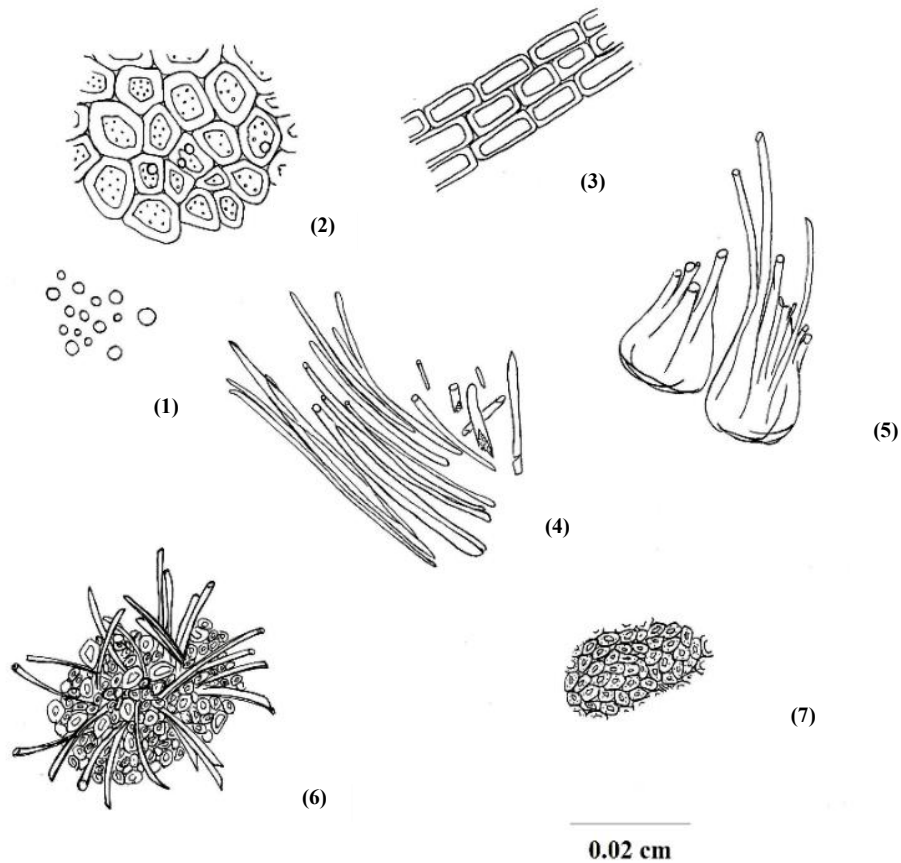
### Microscopic evaluation

The anatomical and histological characters of the seeds were illustrated in Figures 8 and 9 respectively. The cross section of the seed showed bent and twisted lignified unicellular trichomes. Epidermal cells were large thick walled with oblique linear pits arrayed as single layer base on trichomes. The collapsed parenchymas were present as two flat layer. The endosperms consisted of cellulosic parenchymatous cells with hemicellulose and aleurone grains in the cell walls, plasmodesma stained between the walls and oil globules as small oil droplets (fixed oil) in the endospermic cells. The powders showed brown color pigments and fragment tissues as aforementioned.



**Figure 7** Anatomical characters of cross sectional *S. nux-vomica* seed

- |                         |                          |
|-------------------------|--------------------------|
| (1) Testa               | (6) Epidermal cells      |
| (2) Cavity              | (7) Collapsed parenchyma |
| (3) Hilum               | (8) Sclerenchyma         |
| (4) Endosperm           | (9) Plasmodesma          |
| (5) Lignified trichomes | (10) Oil globules        |



**Figure 8** Histological characters of *S. nux-vomica* seed powders

- (1) Oil globules
- (2) Endosperm containing fixed oil and aleurone grains
- (3) Collapsed parenchyma
- (4) Unicellular trichomes rod
- (5) Basal lignified rod
- (6) Sclerenchymatous epidermis of testa in surface view
- (7) Testa and pigments

### Physico-chemical evaluation

The physico-chemical parameters of *S. nux-vomica* seeds were demonstrated in Table 5. The specifications of water content and loss on drying were 8.08 and 8.80 % by weight. The total ash and acid insoluble ash were 1.20 and 0.15 % by weight respectively. The ethanol and water soluble extractive values were 3.90 and 13.12 % by weight respectively.

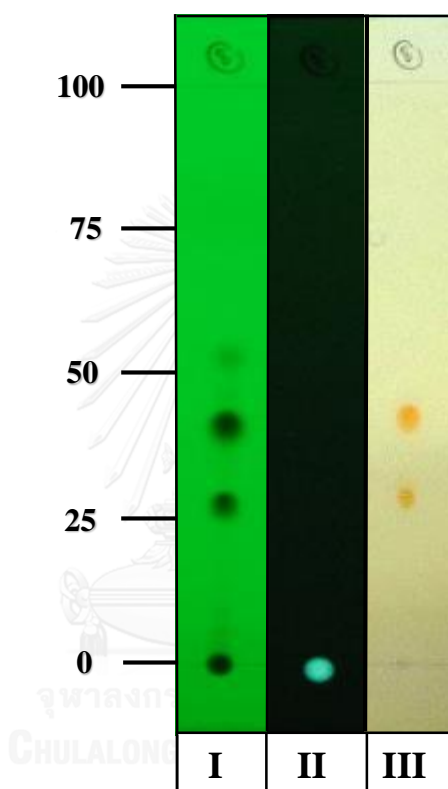
**Table 5** Physico-chemical specifications of *S. nux-vomica* seeds

Content (% by weight)	(Grand mean $\pm$ pooled SD)
Water	8.08 $\pm$ 0.60
Loss on drying	8.80 $\pm$ 0.25
Total ash	1.20 $\pm$ 0.03
Acid insoluble ash	0.15 $\pm$ 0.02
Ethanol soluble extractive value	3.90 $\pm$ 0.33
Water soluble extractive value	13.12 $\pm$ 0.77

\*The 15 different sources of sample throughout Thailand were done in triplicate

### Thin layer chromatographic fingerprint

TLC fingerprint of *S. nux-vomica* seeds ethanolic extract was observed under short and long UV wavelength at 254 nm and 365 nm respectively. The Dragendorff's reagent was used to detect the alkaloid compounds as illustrated in Figure 10.



**Figure 9** TLC fingerprint of *S. nux-vomica* seeds ethanolic extract

Stationary phase: silica gel 60 GF<sub>254</sub>

Mobile phase: toluene: ethyl acetate: diethylamine (7: 2: 1)

**Detection** I = detection under UV 254 nm

II = detection under UV 365 nm

III = detection with Dragendorff's reagent

## Quantitative analysis of strychnine and brucine in *S. nux-vomica* seeds

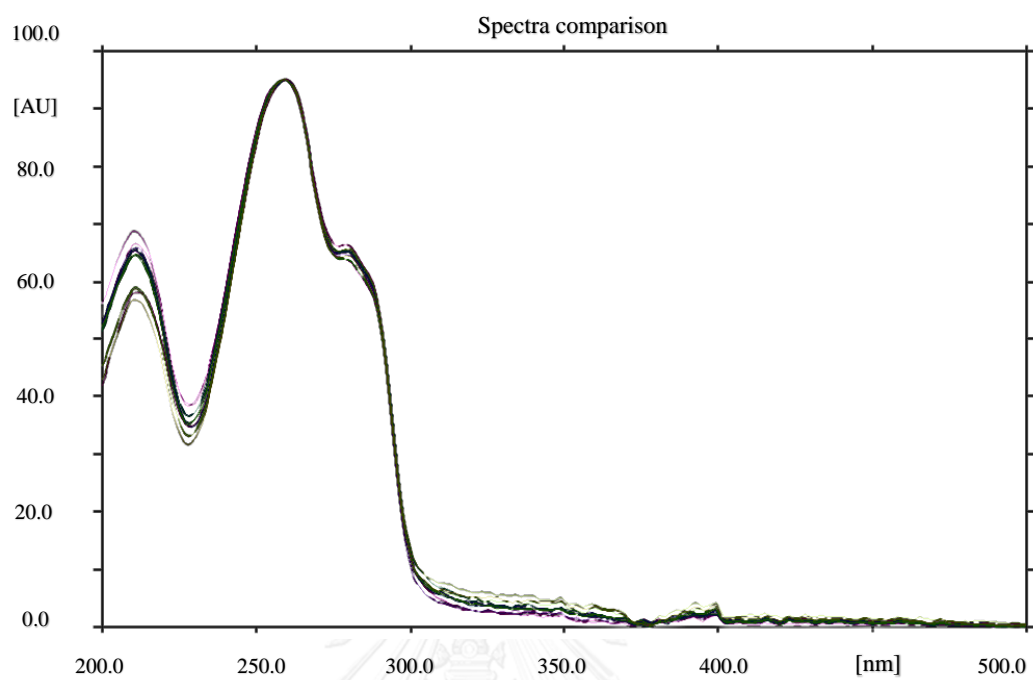
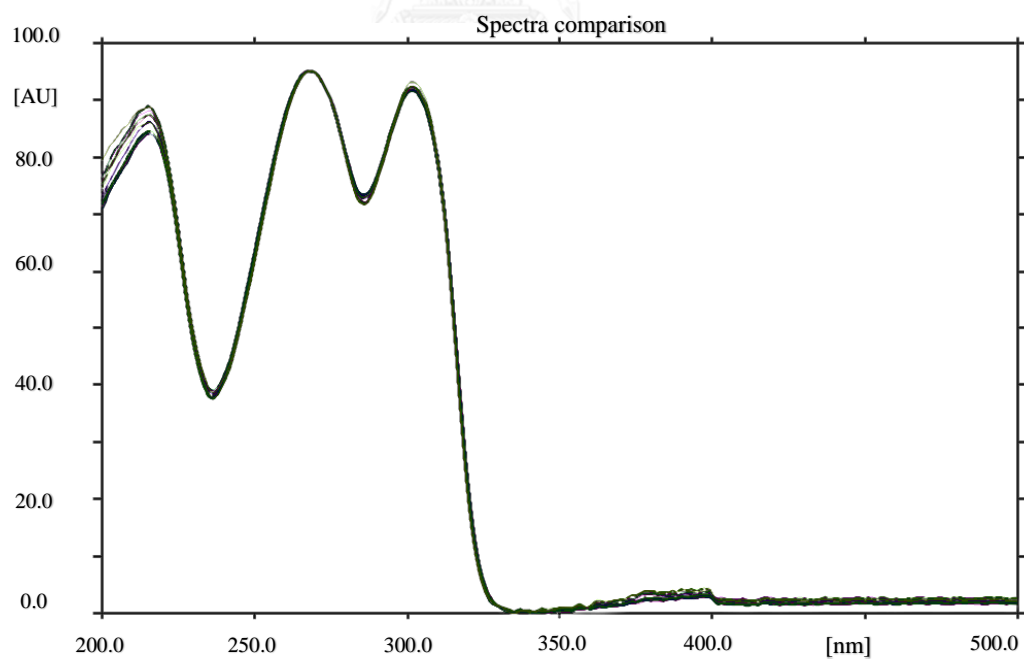
### Ethanollic extract of *S. nux-vomica* seeds

The ethanollic extract yield from dried crude drug of *S. nux-vomica* seeds were established from 15 different sources by Soxhlet apparatus as shown in Table 6. The average percent yield was  $8.45 \pm 3.17$  % by weight.

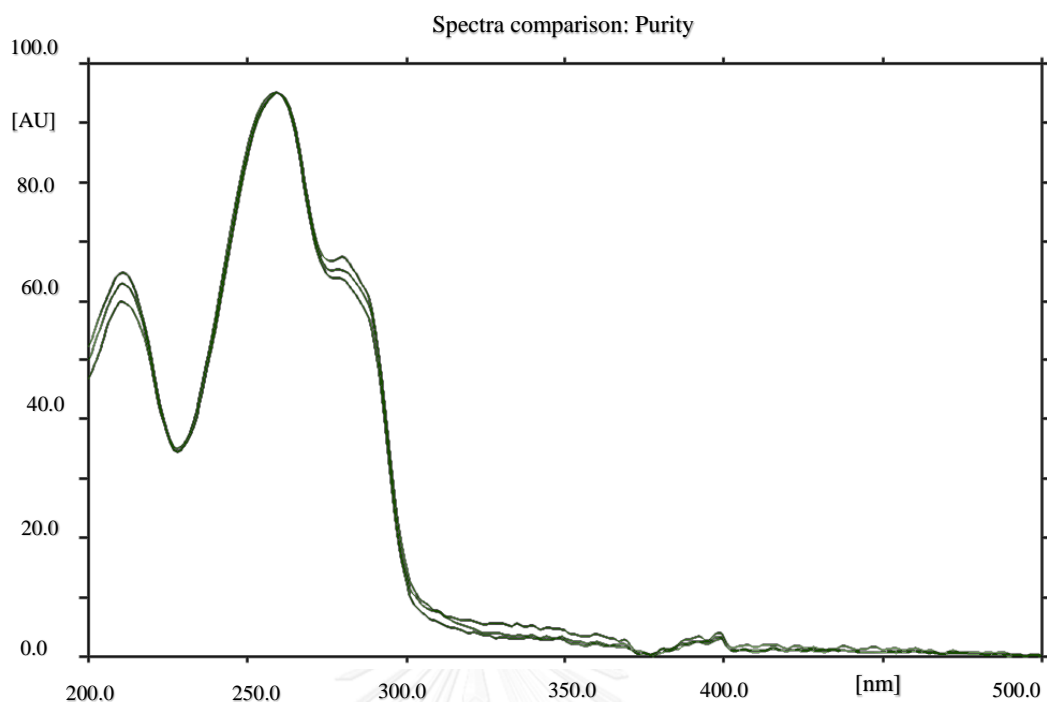
**Table 6** Percent yield of *S. nux-vomica* seeds from 15 different sources in Thailand

Source	Dried weight of crude drug (mg)	Weight of extractive value (mg)	% yield (g/100g)
1	5.00	0.33	6.56
2	5.00	0.54	10.71
3	5.00	0.52	10.47
4	5.00	0.49	9.79
5	5.00	0.73	14.54
6	5.00	0.39	7.89
7	5.00	0.24	4.88
8	5.00	0.63	12.52
9	5.00	0.63	12.67
10	5.00	0.26	5.19
11	5.00	0.42	8.40
12	5.00	0.33	6.70
13	5.00	0.24	4.82
14	5.00	0.33	6.51
15	5.00	0.25	5.08
<b>Average</b>			<b><math>8.45 \pm 3.17</math></b>

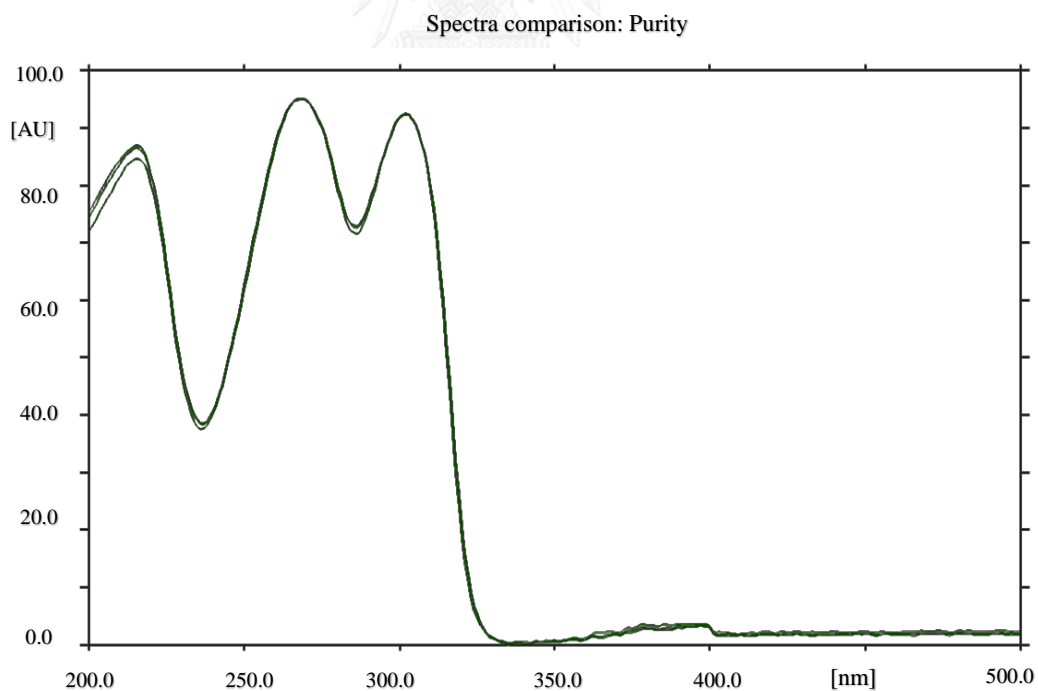
The light absorption spectra of strychnine, brucine standards and ethanollic extract on TLC plate were performed to establish the specificity. The peak identity among standard and ethanollic extract were represented by light absorbance spectra matching as shown in Figure 11 (A), (B). The peak purity was confirmed by spectra matching among peak start, peak apex and peak end as illustrated in Figure 12 (A), (B).

**Specificity****(A)****(B)**

**Figure 10** Absorbance spectra of strychnine (A) and brucine (B) among standard and sample spots representing peak identity



(A)



(B)

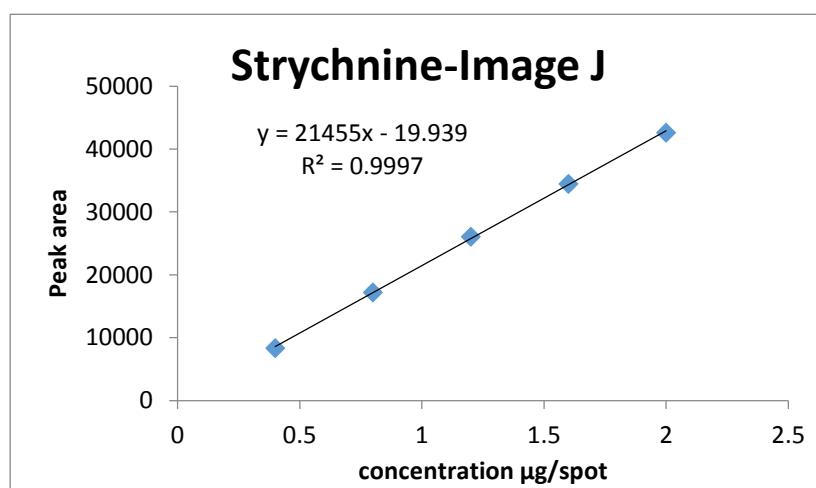
**Figure 11** Absorbance spectra of strychnine (A) and brucine (B) among peak start, peak apex and peak end of sample spots representing peak purity

## TLC image analysis by Image J software

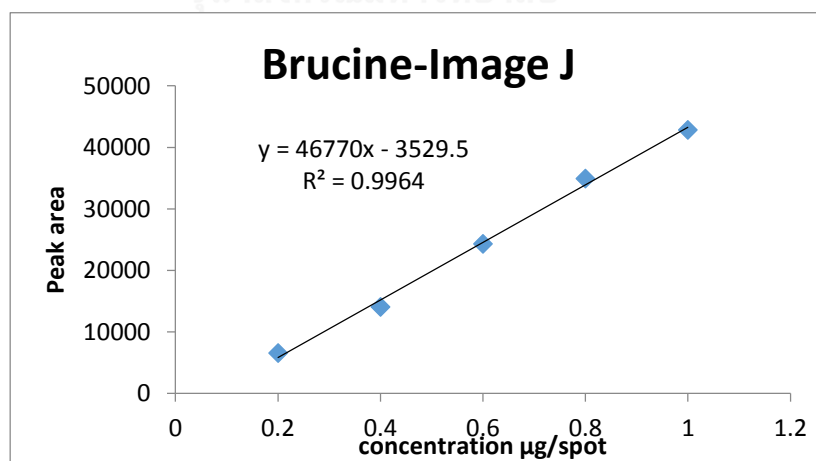
### Method validation

#### Linearity and range

The calibration curves of strychnine and brucine standard compounds were linear (coefficient of determination = 0.99) in the range of 0.4 - 2  $\mu\text{g}/\text{spot}$  and 0.2 - 1  $\mu\text{g}/\text{spot}$ , respectively. The regression equation of strychnine was  $y = 21455x - 19.939$  as shown in Figure 13 (A) and brucine was  $y = 46770x - 3529.5$  as shown in Figure 13 (B).



(A)



(B)

**Figure 12** The calibration curves of strychnine (A) and brucine (B) by TLC image analysis



### Accuracy

The three standard levels of strychnine and brucine compounds were spiked into the sample. The percent recovery was determined in average of  $102.66 \pm 4.66$  as shown in Table 7. The average recovery of brucine was  $92.13 \pm 4.77$  as shown in Table 8.

**Table 7** Accuracy of quantification of strychnine (n=3) in *S. nux-vomica* seeds by TLC image analysis

Strychnine added ( $\mu\text{g}/\text{spot}$ )	Strychnine found ( $\mu\text{g}/\text{spot}$ )	% Recovery
0.0	$0.76 \pm 0.01$	-
0.2	$1.03 \pm 0.05$	$106.61 \pm 4.28$
0.6	$1.42 \pm 0.06$	$103.83 \pm 5.29$
1	$1.72 \pm 0.09$	$97.52 \pm 5.09$
<b>Average</b>		<b><math>102.66 \pm 4.66</math></b>

**Table 8** Accuracy of quantification of brucine (n=3) in *S. nux-vomica* seeds by TLC image analysis

Brucine added ( $\mu\text{g}/\text{spot}$ )	Brucine found ( $\mu\text{g}/\text{spot}$ )	% Recovery
0.0	$0.41 \pm 0.04$	-
0.1	$0.49 \pm 0.02$	$95.27 \pm 7.84$
0.3	$0.67 \pm 0.02$	$94.47 \pm 5.17$
0.5	$0.79 \pm 0.02$	$86.64 \pm 1.97$
<b>Average</b>		<b><math>92.13 \pm 4.77</math></b>

## Precision

The precision was analyzed by three different concentrations of strychnine and brucine in *S. nux-vomica* seeds. The % RSD was performed to determine at the same day of repeatability and different days of intermediate precision as shown in Tables 9 and 10.

**Table 9** Repeatability and intermediate precision of quantification of strychnine in *S. nux-vomica* seeds by TLC image analysis

Repeatability (n=3)		Intermediate precision (n=3)	
Amount ( $\mu\text{g}/\text{spot}$ )	%RSD	Amount ( $\mu\text{g}/\text{spot}$ )	%RSD
1.03 $\pm$ 0.05	4.95	1.08 $\pm$ 0.04	3.79
1.42 $\pm$ 0.06	4.43	1.47 $\pm$ 0.01	0.60
1.72 $\pm$ 0.09	5.33	1.62 $\pm$ 0.02	1.01
<b>Average</b>	<b>4.00 <math>\pm</math> 1.85</b>	<b>Average</b>	<b>3.01 <math>\pm</math> 2.81</b>

**Table 10** Repeatability and intermediate precision of quantification of brucine in *S. nux-vomica* seeds by TLC image analysis

Repeatability (n=3)		Intermediate precision (n=3)	
Amount ( $\mu\text{g}/\text{spot}$ )	%RSD	Amount ( $\mu\text{g}/\text{spot}$ )	%RSD
0.49 $\pm$ 0.02	3.52	0.53 $\pm$ 0.04	6.66
0.67 $\pm$ 0.02	3.19	0.70 $\pm$ 0.02	2.46
0.79 $\pm$ 0.02	2.48	0.83 $\pm$ 0.01	1.57
<b>Average</b>	<b>4.77 <math>\pm</math> 3.44</b>	<b>Average</b>	<b>4.71 <math>\pm</math> 3.19</b>

## Detection limit and quantitation limit

The LOD and LOQ were evaluated based on the residual standard deviation of a regression line and the slope of calibration curve. The regression equation of  $y = 21455x - 19.939$  for strychnine and  $y = 46770x - 3529.5$  for brucine were illustrated in Figure 13 (A), (B). The LOD of strychnine and brucine were assessed value as 0.04 and 0.07  $\mu\text{g}/\text{spot}$  respectively. The LOQ of strychnine and brucine were assessed value as 0.13 and 0.22  $\mu\text{g}/\text{spot}$  respectively.

### Robustness

The different ratios of mobile phase were studied to determine the robustness of strychnine and brucine in *S. nux-vomica* seeds as % RSD. The peak areas of strychnine and brucine using three mobile phase systems were shown in Tables 11, 12.

**Table 11** Robustness of quantification of strychnine in *S. nux-vomica* seeds by TLC image analysis

Mobile phase ratio of toluene : ethyl acetate : diethylamine	Peak area	
	Strychnine standard	Sample
7 : 2 : 1	36201.25	40004.47
6 : 3 : 1	35759.90	38648.46
8 : 1 : 1	33420.32	41208.11
<b>Mean ± SD</b>	<b>35127.16 ± 1966.41</b>	<b>39953.68 ± 851.10</b>
<b>% RSD</b>	<b>5.60</b>	<b>2.13</b>

**Table 12** Robustness of quantification of brucine in *S. nux-vomica* seeds by TLC image analysis

Mobile phase ratio of toluene : ethyl acetate : diethylamine	Peak area	
	Brucine standard	Sample
7 : 2 : 1	6731.21	36235.70
6 : 3 : 1	5825.41	32218.85
8 : 1 : 1	6706.95	34567.50
<b>Mean ± SD</b>	<b>6421.19 ± 17.16</b>	<b>34340.69 ± 1179.59</b>
<b>% RSD</b>	<b>0.27</b>	<b>3.43</b>

### The contents of strychnine and brucine in *S. nux-vomica* seeds by TLC image analysis

The amounts of strychnine and brucine in ethanolic extract were examined in triplicate using TLC image by Image J software. The contents of these compounds in *S. nux-vomica* seeds were reported as grams per 100 grams of dried crude drug as shown in Table 13, 14. The average of strychnine and brucine contents were found to be  $1.09 \pm 0.56$  and  $0.48 \pm 0.30$  g/100g respectively.

**Table 13** The content of strychnine in *S. nux-vomica* seeds in % by weight by TLC image analysis

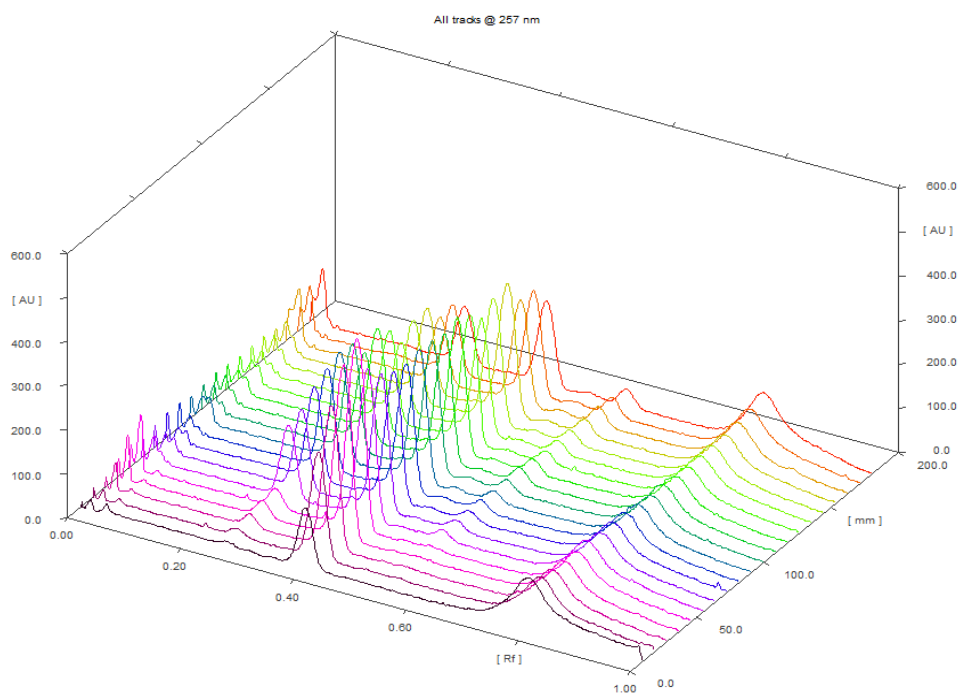
Source	Ethanolic extract (g/100g of dried crude drug)	Strychnine in ethanolic extract (g/g extract)	Strychnine in <i>S.</i> <i>nux-vomica</i> seeds (g/100g of dried crude drug)
1	6.56	0.15	0.96
2	10.71	0.14	1.47
3	10.47	0.13	1.33
4	9.79	0.13	1.29
5	14.54	0.14	2.08
6	7.89	0.14	1.07
7	4.88	0.13	0.62
8	12.52	0.15	1.87
9	12.67	0.15	1.92
10	5.19	0.12	0.64
11	8.40	0.13	1.06
12	6.70	0.12	0.82
13	4.82	0.08	0.39
14	6.51	0.09	0.56
15	5.08	0.07	0.34
<b>Average</b>			<b>1.09 ± 0.56</b>

**Table 14** The content of brucine in *S. nux-vomica* seeds in % by weight by TLC image analysis

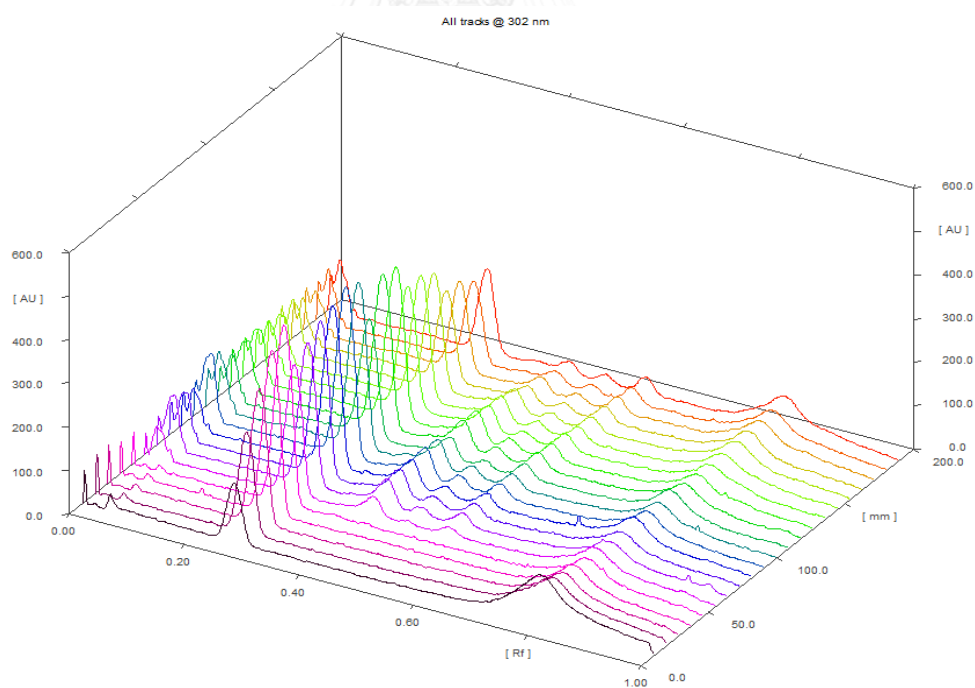
Source	Ethanollic extract (g/100g of dried crude drug)	Brucine in ethanollic extract (g/g extract)	Brucine in <i>S. nux- vomica</i> seeds (g/100g of dried crude drug)
1	6.56	0.05	0.32
2	10.71	0.05	0.59
3	10.47	0.07	0.68
4	9.79	0.07	0.68
5	14.54	0.08	1.11
6	7.89	0.07	0.57
7	4.88	0.05	0.23
8	12.52	0.07	0.85
9	12.67	0.07	0.84
10	5.19	0.05	0.24
11	8.40	0.05	0.39
12	6.70	0.04	0.27
13	4.82	0.03	0.14
14	6.51	0.03	0.18
15	5.08	0.03	0.13
	<b>Average</b>		<b>0.48 ± 0.30</b>

**TLC densitometry**

TLC densitograms of strychnine, brucine standards and 15 samples of *S. nux-vomica* seeds were performed under UV wavelength of 257 and 302 nm respectively as shown in figure 14 (A), (B).



(A)



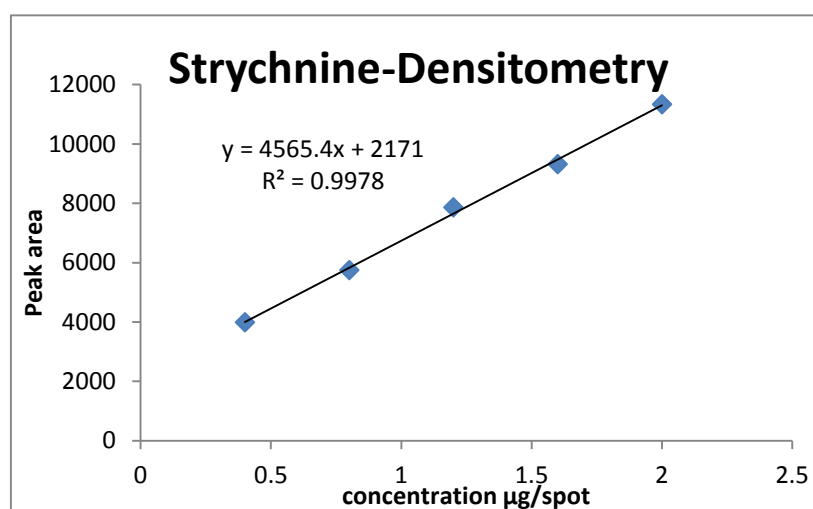
(B)

**Figure 13** TLC densitograms of 15 samples and standard strychnine (A) and brucine (B) under 257 and 302 nm respectively

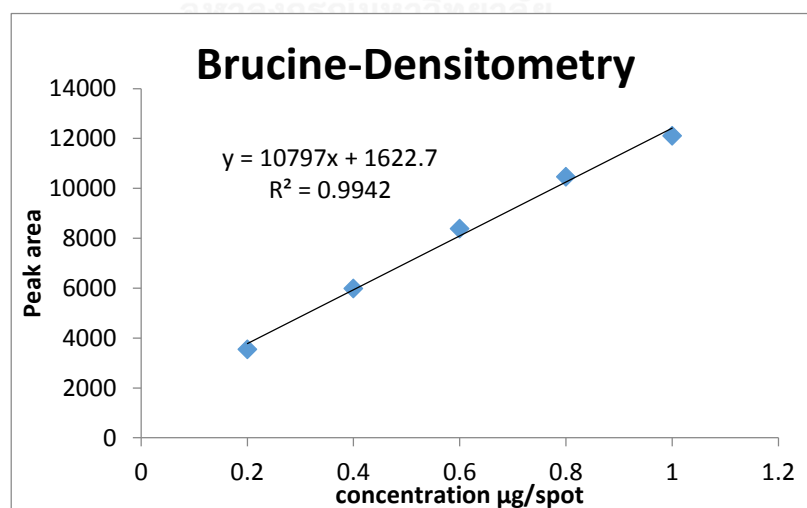
## Method validation

### Linearity and range

The calibration curves of strychnine and brucine standard compounds were linear (coefficient of determination = 0.99) in the range of 0.4 - 2  $\mu\text{g}/\text{spot}$  and 0.2 - 1  $\mu\text{g}/\text{spot}$  respectively. The regression equation of strychnine was  $y = 4565.4x + 2171$  as shown in Figure 15 (A) and brucine was  $y = 10797x + 1622.7$  as shown in Figure 15 (B).



(A)



(B)

**Figure 14** The calibration curves of strychnine (A) and brucine (B) by TLC densitometry

### Accuracy

The three standard levels of strychnine and brucine compounds were spiked into the sample. The percent recovery was determined in average of  $115.65 \pm 2.17$  as shown in Table 15. The average of recovery of brucine was  $95.08 \pm 3.18$  as shown in Table 16.

**Table 15** Accuracy of quantification of strychnine (n=3) in *S. nux-vomica* seeds by TLC densitometry

<b>Strychnine added (<math>\mu\text{g}/\text{spot}</math>)</b>	<b>Strychnine found (<math>\mu\text{g}/\text{spot}</math>)</b>	<b>% Recovery</b>
0.0	$0.61 \pm 0.01$	-
0.2	$0.92 \pm 0.01$	$113.30 \pm 1.55$
0.6	$1.42 \pm 0.02$	$117.57 \pm 1.71$
1	$1.87 \pm 0.05$	$116.08 \pm 3.44$
<b>Average</b>		<b><math>115.65 \pm 2.17</math></b>

**Table 16** Accuracy of quantification of brucine (n=3) in *S. nux-vomica* seeds by TLC densitometry

<b>Brucine added (<math>\mu\text{g}/\text{spot}</math>)</b>	<b>Brucine found (<math>\mu\text{g}/\text{spot}</math>)</b>	<b>% Recovery</b>
0.0	$0.40 \pm 0.01$	-
0.1	$0.49 \pm 0.00$	$97.94 \pm 1.20$
0.3	$0.67 \pm 0.02$	$95.64 \pm 2.41$
0.5	$0.83 \pm 0.01$	$91.66 \pm 1.32$
<b>Average</b>		<b><math>95.08 \pm 3.18</math></b>



## Precision

The precision was analyzed by three different concentrations of strychnine and brucine in *S. nux-vomica* seeds. The % RSD was performed to determine at the same day of repeatability and different days of intermediate precision as shown in Table 17, 18.

**Table 17** Repeatability and intermediate precision of quantification of strychnine in *S. nux-vomica* seeds by TLC densitometry

Repeatability (n=3)		Intermediate precision (n=3)	
Amount ( $\mu\text{g/spot}$ )	%RSD	Amount ( $\mu\text{g/spot}$ )	%RSD
0.92 $\pm$ 0.01	0.94	0.96 $\pm$ 0.04	3.98
1.42 $\pm$ 0.02	1.45	1.40 $\pm$ 0.00	0.08
1.87 $\pm$ 0.05	2.52	1.81 $\pm$ 0.02	1.29
<b>Average</b>	<b>1.66 <math>\pm</math> 0.66</b>	<b>Average</b>	<b>3.13 <math>\pm</math> 3.16</b>

**Table 18** Repeatability and intermediate precision of quantification of brucine in *S. nux-vomica* seeds by TLC densitometry

Repeatability (n=3)		Intermediate precision (n=3)	
Amount ( $\mu\text{g/spot}$ )	%RSD	Amount ( $\mu\text{g/spot}$ )	%RSD
0.49 $\pm$ 0.00	1.01	0.51 $\pm$ 0.01	2.53
0.67 $\pm$ 0.02	2.76	0.71 $\pm$ 0.02	3.11
0.83 $\pm$ 0.01	0.62	0.89 $\pm$ 0.04	4.05
<b>Average</b>	<b>1.57 <math>\pm</math> 0.96</b>	<b>Average</b>	<b>2.78 <math>\pm</math> 1.10</b>

## Detection limit and quantitation limit

The LOD and LOQ were evaluated based on the residual standard deviation of a regression line and the slope of calibration curve. The regression equation of  $y = 4565.4x + 2171$  for strychnine and  $y = 10797x + 1622.7$  for brucine were illustrated in Figure 15. The LOD of strychnine and brucine were assessed value as 0.22 and 0.11  $\mu\text{g/spot}$  respectively. The LOQ of strychnine and brucine were assessed value as 0.68 and 0.32  $\mu\text{g/spot}$  respectively.

### Robustness

The different ratios of mobile phase were studied to determine the robustness of strychnine and brucine in *S. nux-vomica* seeds as % RSD. The peak area of strychnine and brucine using three mobile phase systems were shown in Table 19, 20.

**Table 19** Robustness of quantification of strychnine in *S. nux-vomica* seeds by TLC densitometry

Mobile phase ratio of toluene : ethyl acetate : diethylamine	Peak area	
	Strychnine standard	Sample
7 : 2 : 1	6902.81	9944.37
6 : 3 : 1	7414.81	9373.88
8 : 1 : 1	7206.10	11187.67
<b>Mean ± SD</b>	<b>7174.57 ± 214.46</b>	<b>10168.64 ± 879.15</b>
<b>% RSD</b>	<b>2.99</b>	<b>8.65</b>

**Table 20** Robustness of quantification of brucine in *S. nux-vomica* seeds by TLC densitometry

Mobile phase ratio of toluene : ethyl acetate : diethylamine	Peak area	
	Brucine standard	Sample
7 : 2 : 1	2606.42	8383.08
6 : 3 : 1	2557.93	8481.35
8 : 1 : 1	2569.74	8551.88
<b>Mean ± SD</b>	<b>2578.03 ± 25.93</b>	<b>8472.10 ± 119.36</b>
<b>% RSD</b>	<b>1.01</b>	<b>1.41</b>

### The contents of strychnine and brucine in *S. nux-vomica* seeds by TLC densitometry

The amounts of strychnine and brucine in ethanolic extract were examined in triplicate using TLC densitometry. The contents of these compounds in *S. nux-vomica* seeds were reported as grams per 100 grams of dried crude drug as shown in Table 21, 22. The average of strychnine and brucine contents were found to be  $1.03 \pm 0.51$  and  $0.46 \pm 0.28$  g/100g respectively.

**Table 21** The content of strychnine in *S. nux-vomica* seeds in % by weight by TLC densitometry

Source	Ethanolic extract (g/100g of dried crude drug)	Strychnine in ethanolic extract (g/g extract)	Strychnine in <i>S.</i> <i>nux-vomica</i> seeds (g/100g of dried crude drug)
1	6.56	0.14	0.93
2	10.71	0.13	1.38
3	10.47	0.12	1.21
4	9.79	0.12	1.20
5	14.54	0.13	1.92
6	7.89	0.13	1.01
7	4.88	0.12	0.56
8	12.52	0.14	1.73
9	12.67	0.14	1.78
10	5.19	0.11	0.59
11	8.40	0.12	0.99
12	6.70	0.12	0.81
13	4.82	0.08	0.39
14	6.51	0.09	0.58
15	5.08	0.07	0.34
	<b>Average</b>		<b>1.03 ± 0.51</b>

**Table 22** The content of brucine in *S. nux-vomica* seeds in % by weight by TLC densitometry

Source	Ethanolic extract (g/100g of dried crude drug)	Brucine in ethanolic extract (g/g extract)	Brucine in <i>S.</i> <i>nux-vomica</i> seeds (g/100g of dried crude drug)
1	6.56	0.05	0.30
2	10.71	0.05	0.56
3	10.47	0.06	0.65
4	9.79	0.07	0.64
5	14.54	0.07	1.03
6	7.89	0.07	0.52
7	4.88	0.04	0.22
8	12.52	0.06	0.79
9	12.67	0.06	0.80
10	5.19	0.04	0.23
11	8.40	0.05	0.38
12	6.70	0.04	0.29
13	4.82	0.03	0.13
14	6.51	0.03	0.19
15	5.08	0.03	0.13
	<b>Average</b>		<b>0.46 ± 0.28</b>

### The comparison of strychnine and brucine contents using TLC image analysis and TLC densitometry

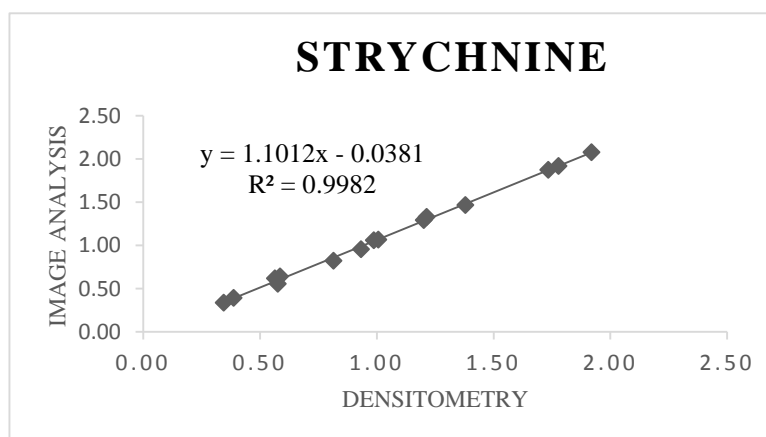
The contents of strychnine and brucine by TLC image analysis and TLC densitometry were not much different (Table 15). However, the results from TLC image analysis tended to be a little bite higher than the results from TLC densitometer which led to statistical significant difference ( $P < 0.01$  by pared  $t$ -test). The relationship equations between strychnine and brucine quantification by both methods were demonstrated in Figure 16 (A), (B).

**Table 23** Comparison of strychnine content between TLC image analysis and TLC densitometry

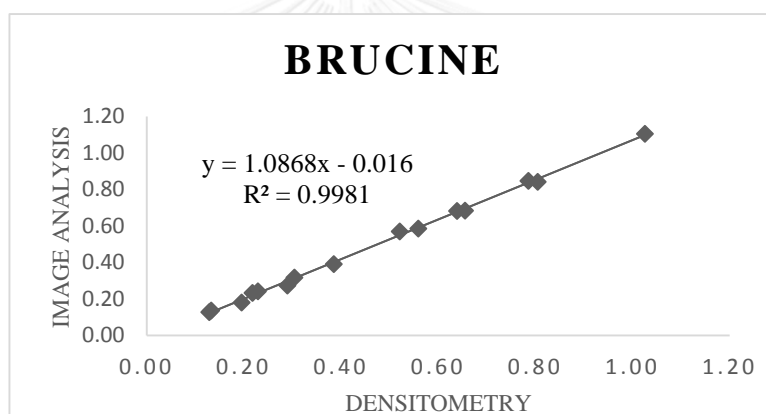
Source	Strychnine content (% by weight)		
	TLC densitometry	TLC image analysis	Difference (TLC image – TLC densitometry)
1	0.93	0.96	0.02
2	1.38	1.47	0.09
3	1.21	1.33	0.12
4	1.20	1.29	0.09
5	1.92	2.08	0.16
6	1.01	1.07	0.06
7	0.56	0.62	0.05
8	1.73	1.87	0.14
9	1.78	1.92	0.14
10	0.59	0.64	0.06
11	0.99	1.06	0.07
12	0.81	0.82	0.01
13	0.39	0.39	0.01
14	0.58	0.56	-0.02
15	0.34	0.34	-0.01

**Table 24** Comparison of brucine content between TLC image analysis and TLC densitometry

Source	Brucine content (% by weight)		
	TLC densitometry	TLC image analysis	Difference (TLC image – TLC densitometry)
1	0.30	0.32	0.01
2	0.56	0.59	0.03
3	0.65	0.68	0.03
4	0.64	0.68	0.04
5	1.03	1.11	0.08
6	0.52	0.57	0.05
7	0.22	0.23	0.02
8	0.79	0.85	0.06
9	0.80	0.84	0.04
10	0.23	0.24	0.01
11	0.38	0.39	0.01
12	0.29	0.27	-0.02
13	0.13	0.14	0.00
14	0.19	0.18	-0.01
15	0.13	0.13	0.00



(A)

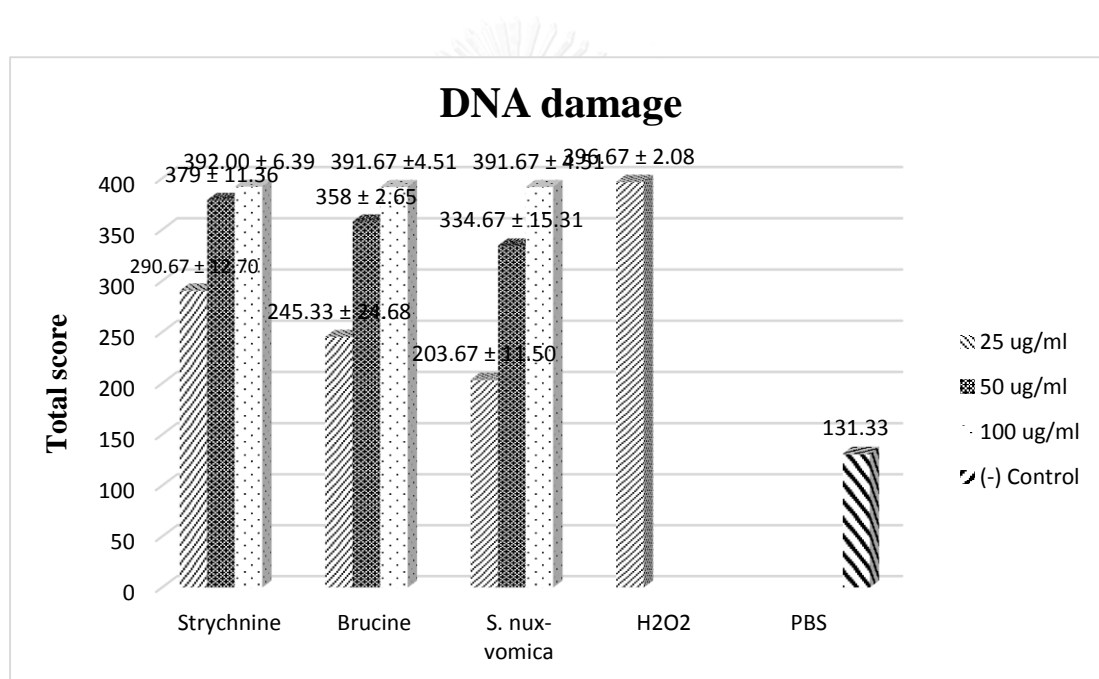


(B)

**Figure 15** The linear graph comparisons for the analysis results of strychnine (A) and brucine (B) between densitometry and image analysis

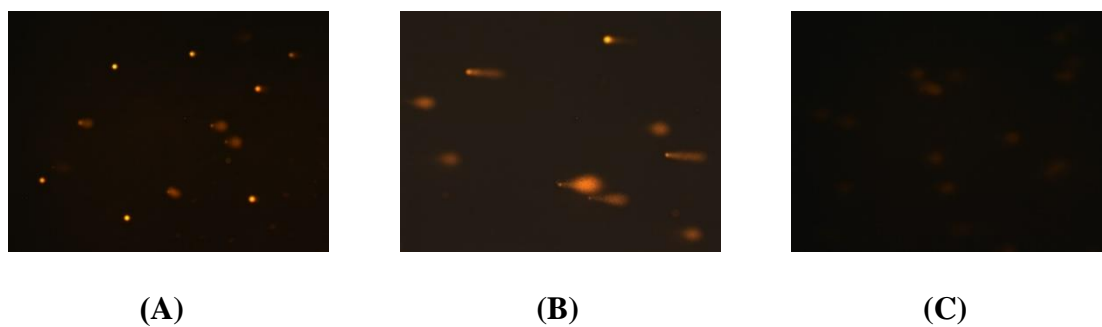
### DNA damage in human lymphocyte cells

The five classes of visual scoring analysis, 100 comets per slide in each of concentrations (n = 3) were classified between 0 – 400 arbitrary unit. The total scores of DNA damage were established in triplicate. The hydrogen peroxide (H<sub>2</sub>O<sub>2</sub>) that used as positive control showed the highest of DNA damaged as 396 scores whereas phosphate buffer saline pH 7.4 (PBS) showed the lowest scores of DNA damage. The treated cells at 25 - 100 µg/ml of strychnine, brucine and ethanolic extract of *S. nuxvomica* seeds were demonstrated dose-dependent relationship of DNA damage as illustrated in Figures 17 and 18.

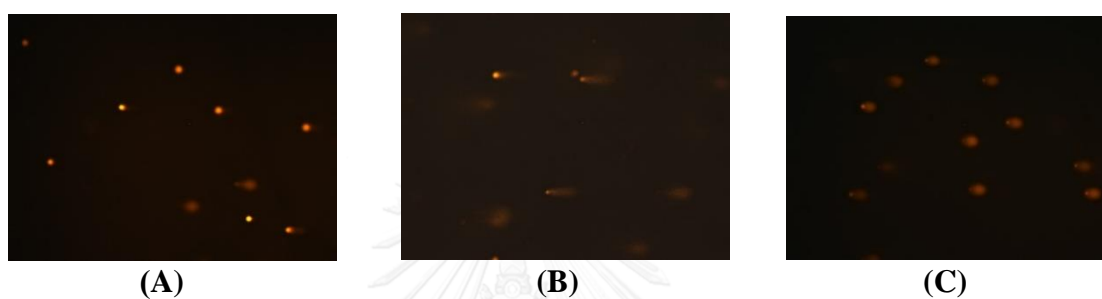


**Figure 16** The total scores of DNA damage in human lymphocytes cells

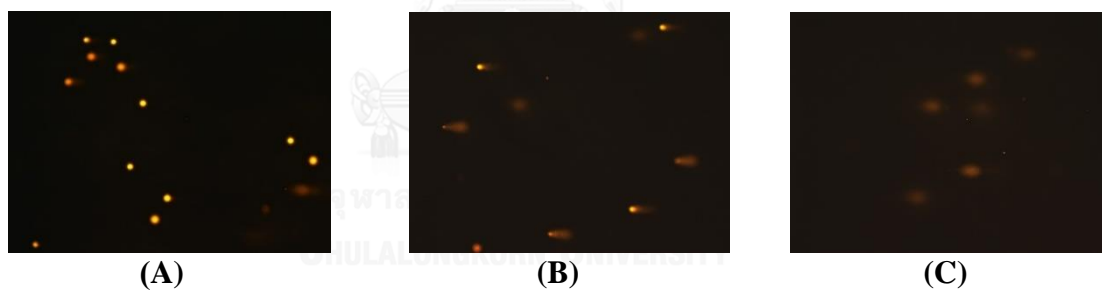




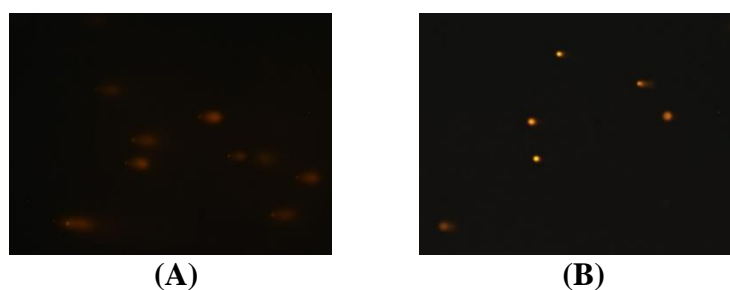
**Figure 18.1** Strychnine (A) 25 µg/ml (B) 50 µg/ml and (C) 100 µg/ml



**Figure 18.2** Brucine (A) 25 µg/ml (B) 50 µg/ml and (C) 100 µg/ml



**Figure 18.3** *S. nux-vomica* seeds (A) 25 µg/ml (B) 50 µg/ml and (C) 100 µg/ml



**Figure 18.4** Positive control ( $H_2O_2$ ) (A) 25 µg/ml and negative control (PBS) (B)

**Figure 17** DNA damage in human lymphocytes cells

## CHAPTER V

### DISCUSSION AND CONCLUSION

The quality control methods are important for the standardization of plant materials. The modern control techniques are recommended to evaluate the identity, purity and quality of the plant materials. *Strychnos nux-vomica* seed pharmacognostic specification was established in terms of macroscopic and microscopic evaluations, physico-chemical parameters and TLC fingerprint.

Macroscopic and microscopic methods are the basic techniques to identify and authenticate the plant materials. These methods are the cheapest and simplest to evaluate the correct plant materials. The macroscopic examination indicates the shape, size, color and cut surface of seeds. Microscopic evaluation is beneficial for fragments and the powder form of crude drug [39]. The characteristics of twig, cross section and powders of dried seed were drawn from the observation as illustrated in the results. In the previous study, transverse section and powders of crude drug were presented with lignified trichomes, basal lignified rod, endosperm and sclerenchymatous epidermis [59, 60]. These evaluations give a clear idea about the specific characters as organoleptic and histological characters.

The physico-chemical properties are used to evaluate the quality and purity of crude drug. The various parameters give the quality information of plant materials. The moisture in the crude drug makes possible enzymatic destruction of active principles. It may be encouraged by molds and bacteria during storage. Water content of dried seeds of *S. nux-vomica* were found to be  $8.08 \pm 0.60$  % by weight. The content after drying of crude drug is also needed to be tested in terms of loss on drying, this test determines both water and volatile matters of crude drug. This study showed the result of loss on drying as  $8.80 \pm 0.25$  % by weight which was similar to the content reported in India as  $7.83 \pm 0.28$  % by weight [61]. The China pharmacopoeia revealed percent of loss on drying not more than 13.0 [62, 63]. The environment of weather might be caused variation in water content. The total amount of ash remains the inorganic elements and their salts of the crude drug after incineration. The result of total ash in *S. nux-vomica* seeds showed  $1.20 \pm 0.03$  % by weight and the result in India showed 4.23

$\pm 0.25$  % by weight [61]. The pharmacopoeia of China and Japan were revealed the total ash not more than 2.0 and 3.0 % respectively [63, 64]. The inorganic elements as carbonates and phosphates are depreciated after boiling the ash with acid. The acid insoluble ash in this study was  $0.15 \pm 0.01$  % by weight and result from India was  $3.06 \pm 0.05$  % by weight [61]. Extractive values indicated the chemicals in plant materials that soluble in the particular solvent. The various solvents could be used to dissolve the substances which their plant material appreciation. The yields of water extractive matters were higher than the ethanol extractives as  $13.12 \pm 0.77$  and  $3.90 \pm 0.33$  % by weight by maceration methods respectively. In the previous study, percent yields of water, ethanol and 50 % ethanol extraction by Soxhlet apparatus were  $8.40 \pm 0.36$ ,  $2.20 \pm 0.15$  and  $9.10 \pm 0.50$  % by weight respectively [61]. The fingerprinting analysis is a method to investigate the phytochemical compounds quantitatively. Stationary phase of silica gel GF<sub>254</sub> TLC plate and the mobile phase of toluene: ethyl acetate: diethylamine (7: 2: 1 v/v) were suitable to give clear the multi-component of chemical compounds.

For quantitative analysis, the exhausted ethanolic extract yields from 15 sources of *S. nux-vomica* seeds were found to be 4.82 – 14.54 % by weight. In previous study, the ethanolic extract yield of *S. nux-vomica* seeds which purchased from Jodhpur market in India was 2.20 % by weight [61]. These results give a different yield by the same method. It may be due to the chemical constituent in the different cultivation areas.

TLC image analysis and TLC densitometry were used to quantitatively analyze strychnine and brucine compounds in *S. nux-vomica* seeds. TLC image analysis is one of methods to quantify the content of chemical compounds. The image J software is free software which diminished the expenses. It can be adapted for assessment of quantitative TLC analysis. The suitable solvent system of mobile phase were able to separate the target compounds. In the previous study [4], the solvent system of chloroform: ethyl acetate: diethylamine (0.5: 8.5: 1 v/v) was used to separate the two compounds clearly at hRf 55 and 42 which looked the same as this study that used the mobile phase of toluene: ethyl acetate: diethylamine (7: 2: 1 v/v) resulting in hRf 50 and 32.5 for strychnine and brucine respectively. TLC densitometry is widely used to

quantify the amount of compound in herbal materials [4]. This method is reliable, precise and accurate. It is an easy automatic equipment that quite expensiveness. In this study, the absorbance mode for strychnine and brucine were scanned through UV absorbance spectra under the range of 200 – 500 nm among standard and samples. The maximum absorption wavelength of 257 and 302 nm for strychnine and brucine were used for the quantitative analysis. It was similar to the absorbance mode from previous study as 264, 306 nm [4] and 257, 304 nm for strychnine and brucine respectively [9].

The validation of these methods were following ICH guideline which consisted of specificity, linearity, accuracy, precision, limit of detection (LOD), limit of quantitation (LOQ) and robustness. For the accuracy, the percent recovery of TLC image analysis and TLC densitometry were average of  $102.66 \pm 4.66$  and  $115.65 \pm 2.17$  for strychnine respectively and  $92.13 \pm 4.77$  and  $95.08 \pm 3.18$  for brucine respectively. The results were accepted in the range of 80 – 120 % [65]. The repeatability and intermediate precision of strychnine and brucine were not more than 5 % RSD that acceptable value by those methods [65]. The linearity relationships of both methods were acceptable in the range of 5 concentrations with coefficient of determination (0.99). The LOD and LOQ based on the residual standard deviation of regression line and the slope of each regression equations were accepted. These process were robust due to small changes in the mobile phase composition. The mobile phase volume or the duration of saturated TLC chamber can be used to ensure the method [4].

The strychnine and brucine contents which analyzed by TLC image analysis (Image J software) and TLC densitometry (TLC scanner with winCATs) were found to be  $1.09 \pm 0.56$ ,  $0.48 \pm 0.30$  and  $1.03 \pm 0.51$ ,  $0.46 \pm 0.28$  g/100g respectively. The pharmacopoeia of Japan revealed that percent of strychnine in *Strychnos nux-vomica* seeds was not less than 1.15 % [64]. In India, the content of two compounds in *S. nux-vomica* seeds were  $2.79 \pm 0.01$  and  $0.89 \pm 0.02$  % by weight respectively [9] and the pulp of *S. nux-vomica* fruit were 1.89 and 0.82 % by weight respectively by TLC densitometric method [4]. This study revealed that the contents of two compounds by TLC image analysis and TLC densitometry were equivalent, however the results from TLC image analysis tended to be a little bit higher than the results from TLC densitometry which led to statistical significant difference ( $P < 0.01$  by pared *t*-test).

TLC image analysis by Image J software can be used as an alternative method to TLC densitometry. It is reliable, fast and cheap than other methods.

Comet assay is one of the methods to assess the genotoxicity. It is a standard test for chemical *in vitro* prior to evaluate the genotoxic potential of compounds in *in vivo* model. The advantages of comet assay include (1) the ability to apply to any tissues in eukaryotic cells, (2) single cell detection, more robust statistical analyses, (3) the multiple classes of DNA damage monitoring, (4) a small number of cells per sample (< 10,000) requiring and (5) very sensitive method to detect the low levels of DNA damage. The assay is simple, versatile and ease for application [11, 54, 66]. This assay was assigned to treat with human lymphocyte cells, the alkaline pH > 13 used to assess single and double strand DNA breaks, alkali-labile sites, crosslinks and incomplete DNA repair sites. DNA damage was classified according to DNA tailing as five classes by visual scoring. The results of this study indicated that the strychnine, brucine standards and *S. nux-vomica* seed extract induced DNA damage. At low concentration of 25 µg/ml, the comet tails were scored as 290, 245 and 203 for those samples respectively. The 50 µg/ml were scored as 379, 358 and 334 for those samples respectively. The highest score at 100 µg/ml were 392, 391 and 391 for those samples respectively. Among these treated samples, strychnine induced higher DNA damage than brucine and extract. The potential of DNA damage seemed to be increased with the dose-dependent relationship. The negative control (PBS) score was 131 and the positive control (H<sub>2</sub>O<sub>2</sub>) score was 396. In the previous study, *S. nux-vomica* extract at 50 µg/ml induced DNA damage compared to the negative control [53].

This research provides the quality specification and strychnine, brucine contents in *S. nux-vomica* seeds that can be used to control the quality of these crude drugs in Thailand. The simple method of TLC image analysis can be used to quantify the active components of this plant material. Furthermore, this research assesses the dose-dependent relationship of the DNA damage potential in *S. nux-vomica* seeds.

## REFERENCES



1. Mukherjee, P.K., *Quality control of herbal drugs*. 2007, New Delhi, India: business horizons.
2. World Health Organization, *Quality control method for medicinal plant material*. 1998, Geneva: WHO.
3. มุลินธิพันธุ์ ฟุ้งส่งเสริมการแพทย์ไทยเดิม, ตำราการแพทย์ไทยเดิม(แพทยศาสตร์สงเคราะห์ ฉบับอนุรักษ) เล่ม 1. Vol. 1. 2550, กรุงเทพฯ: สุภวณิชการพิมพ์.
4. Rathi, A., et al., *TLC Determination of Strychnine and Brucine of Strychnos nuxvomica in Ayurveda and Homeopathy Drugs*. *Chromatographia*, 2008. **67**(7-8): p. 607-613.
5. Cai, B., et al., *Processing of Nux Vomica. VII. Antinociceptive Effects of Crude Alkaloids from the Processed and Unprocessed Seeds of Strychnos nux-vomica in Mice*. *Biological & Pharmaceutical Bulletin*, 1996. **19**(1): p. 127-131.
6. วุฒิ วุฒิชรรณเวช, หลักเภสัชกรรมไทย. 2542, กรุงเทพฯ: เอ็น.พี.สกรีนพรีนติ้ง.
7. Cai, B.C., et al., *Cytotoxicities of alkaloids from processed and unprocessed seeds of Strychnos nux-vomica*. *Zhongguo yao li xue bao = Acta pharmacologica Sinica*, 1998. **19**(5): p. 425-428.
8. Choi, Y.H., et al., *Analysis of strychnine from detoxified Strychno nux-vomica seeds using liquid chromatography–electrospray mass spectrometry*. *Journal of Ethnopharmacology*, 2004. **93**(1): p. 109-112.
9. Dhalwal, K., et al., *Development and validation of a TLC-densitometric method for the simultaneous quantitation of strychnine and brucine from Strychnos spp. and its formulations*. *Journal of Chromatographic Science*, 2007. **45**(10): p. 706-9.
10. Li, Y., et al., *Separation and determination of strychnine and brucine in Strychnos nux-vomica L. and its preparation by nonaqueous capillary electrophoresis*. *Journal of Pharmaceutical and Biomedical Analysis*, 2006. **41**(2): p. 400-407.
11. Costa S. and Teixeira J.P., *Comet Assay*. *Encyclopedia of Toxicology*, 2014. **1**.
12. Collins, A.R., *The comet assay for DNA damage and repair: principles, applications, and limitations*. *Molecular Biotechnology*, 2004. **26**(3): p. 249-61.

13. สำนักงานหอพรรณไม้. ชื่อพรรณไม้แห่งประเทศไทย เต็ม สมิตินันท์. 19/6/2015; Available from: <http://www.dnp.go.th/botany/>.
14. ฐานข้อมูลพรรณไม้องค์การสวนพฤกษศาสตร์. แสงใจ. 2016; Available from: [http://www.qsbg.org/database/botanic\\_book%20full%20option/search.asp?txtsearch=Strychnos+nux-vomica+Linn.&bnsearch=Search](http://www.qsbg.org/database/botanic_book%20full%20option/search.asp?txtsearch=Strychnos+nux-vomica+Linn.&bnsearch=Search).
15. John Robertson. *THE POISON GARDEN website*. 2/12/2015; Available from: [http://thepoison garden.co.uk/atoz/strychnos\\_nuxvomica.htm](http://thepoison garden.co.uk/atoz/strychnos_nuxvomica.htm).
16. สมพร (ภูติยานันต์) หิรัญรามเดช, ตำราการตรวจเอกลักษณ์พืชสมุนไพร เล่ม 2; *Text book of Identification of Medicinal Plants Vol.II*. Vol. 2. 2529, เชียงใหม่: ศูนย์พิมพ์คณะเภสัชศาสตร์ มหาวิทยาลัยเชียงใหม่. 118-121.
17. นิจศิริ เรืองรังษี และ พยอม ตันติวัฒน์, พืชสมุนไพร. 2532, กรุงเทพมหานคร: โรงพิมพ์จุฬาลงกรณ์มหาวิทยาลัย. 139-140.
18. Purwaningsih. *Strychnos nux-vomica L.* 1999; Available from: <http://proseanet.org/prosea/e-prosea.php>.
19. วุฒิ วุฒิชรรณเวช, ย่อเภสัชกรรมไทยและสรรพคุณสมุนไพร. 2548, กรุงเทพฯ: ศิลป์สยามบรรณกิจภัณฑ์และการพิมพ์.
20. Kopp, B., W.P. Bauer, and A. Bernkop-Schnurch, *Analysis of some Malaysian dart poisons*. Journal of Ethnopharmacology, 1992. **36**(1): p. 57-62.
21. Neuwinger, H.D., *Alkaloids in Arrow Poisons*, in *Alkaloids*, M. Roberts and M. Wink, Editors. 1998, Springer US. p. 45-84.
22. Stuartxchange. *Strychnine plants*. 2013; Available from: <http://www.stuartxchange.com/StrychninePlant.html>.
23. Lambert, J.R., R.J. Byrick, and M.D. Hammeke, *Management of acute strychnine poisoning*. Canadian Medical Association Journal, 1981. **124**(10): p. 1268-70.
24. Wood, D.M., et al., *Case report: Survival after deliberate strychnine self-poisoning, with toxicokinetic data*. Critical Care, 2002. **6**(5): p. 456-459.



25. Yan-Yan Xu, Duan-Yun Si, and Chang-Xiao Liu, *Research on bioresponse of active compounds of Strychnos nux-vomica L.* Asian Journal of Pharmacodynamics and Pharmacokinetics, 2009. **9**(3): p. 179-201.
26. Seyffart, G., *Poison index : the treatment of acute intoxication.* 4th ed ed. 1997, Germany: Lengerich ; New York : Pabst Science Publishers.
27. Naik, B.S. and M. Chakrapani, *A rare case of brucine poisoning complicated by rhabdomyolysis and acute renal failure.* Malaysian Journal of Pathology, 2009. **31**(1): p. 67-9.
28. Cai, B.-C., M. Hattori, and T. Namba, *Processing of Nux Vomica. II. : Changes in Alkaloid Composition of the Seeds of Strychnos nux-vomica on Traditional Drug-Processing.* Chemical and Pharmaceutical Bulletin, 1990. **38**(5): p. 1295-1298.
29. Akbar, S., et al., *Use of Strychnos Nux-Vomica (Azraqi) Seeds in Unani System of Medicine: Role of Detoxification.* African Journal of Traditional, Complementary, and Alternative Medicines, 2010. **7**(4): p. 286-290.
30. Deng, X.-K., et al., *The anti-tumor effects of alkaloids from the seeds of Strychnos nux-vomica on HepG2 cells and its possible mechanism.* Journal of Ethnopharmacology, 2006. **106**(2): p. 179-186.
31. Chen, J., et al., *Analgesic and anti-inflammatory activity and pharmacokinetics of alkaloids from seeds of Strychnos nux-vomica after transdermal administration: Effect of changes in alkaloid composition.* Journal of Ethnopharmacology, 2012. **139**(1): p. 181-188.
32. Pratt, R. and H.W. Youngken, *Pharmacognosy: The Study of Natural Drug Substances and Certain Allied Products.* 1951: J. B. Lippincott & Co. . 119-139.
33. ภาควิชาเภสัชวินิจฉัย, ยาและผลิตภัณฑ์จากธรรมชาติ. 2534, กรุงเทพฯ: คณะเภสัชศาสตร์ มหาวิทยาลัยมหิดล. 159.
34. Zhao, N., et al., *New alkaloids from the seeds of Strychnos nux-vomica.* Tetrahedron, 2012. **68**(16): p. 3288-3294.
35. Merck & Co., I., *The Merck Index of chemicals and drugs,* ed. sixth edition. 1952, U.S.A.

36. สมพพร ภูதியานันต์, สมุนไพรโกสี้ตัว เล่ม 6 ว่าด้วยสมุนไพรที่เป็นพิษ. 2546: โรงพิมพ์ตุลย์การพิมพ์. . 116-117.
37. Ohiri, F.C., R. Verpoorte, and A.B. Svendsen, *The African strychnos species and their alkaloids: A review*. Journal of Ethnopharmacology, 1983. **9**(2–3): p. 167-223.
38. Philippe, G., et al., *About the toxicity of some Strychnos species and their alkaloids*. Toxicon, 2004. **44**(4): p. 405-416.
39. S.B.Gokhale, C.K.Kokate, and A.P.Purohit, *Pharmacognosy*. First year diploma in pharmacy, ed. 29. 2009, Maharashtra: Nilali Prakashan.
40. William, C.E., *Trease and Evans' Pharmacognosy*, ed. t. Edition. 2009, Edinburgh, London, New York, Philadelphia St Louis, Sydney, Toronto: Elsevier. 603.
41. สำนักงานโครงการอนุรักษ์พันธุกรรมพืชอันเนื่องมาจากพระราชดำริฯ. โครงการอนุรักษ์พันธุกรรมพืชอันเนื่องมาจากพระราชดำริ สมเด็จพระเทพรัตนราชสุดาฯ สยามบรมราชกุมารี March, 2016; Available from: <http://www.rspg.or.th/index.html>.
42. Chen, J., et al., *Pharmacological evaluation of total alkaloids from nux vomica: effect of reducing strychnine contents*. Molecules, 2014. **19**(4): p. 4395-408.
43. Marques, E.P., et al., *Analytical method for the determination of strychnine in tissues by gas chromatography/mass spectrometry: two case reports*. Forensic Science International, 2000. **110**(2): p. 145-152.
44. Stahl, E., *Drug Analysis by Chromatography and Microscopy*. ann arbor science publishers inc.
45. รัตนา อินทรานุปกรณ์, การตรวจสอบและการสกัดแยกสารสำคัญจากสมุนไพร. 2550, สำนักพิมพ์แห่งจุฬาลงกรณ์มหาวิทยาลัย: กรุงเทพฯ.
46. ปนัดดา พัฒนเวทิน, รงคเลขฉิวบาง. Vol. 1. 2550: โรงพิมพ์มหาวิทยาลัยธรรมศาสตร์วิทยาเขตรังสิต ปทุมธานี 12121.

47. Rasband, W.S., *ImageJ*. 1997–2011, U.S. National Institutes of Health, Bethesda, Maryland, USA,.
48. Friedberg, E.C., L.D. McDaniel, and R.A. Schultz, *The role of endogenous and exogenous DNA damage and mutagenesis*. *Current Opinion Genetics & Development*, 2004. **14**(1): p. 5-10.
49. โอภา วัชรคุปต์, สารต้านอนุมูลอิสระ. Vol. 1. 2549, กรุงเทพฯ: พี.เอส.พี. 190.
50. Makarovskiy, I., et al., *Strychnine--a killer from the past*. *Israel Medical Association Journal*, 2008. **10**(2): p. 142-5.
51. Liu, W., et al., *Genotoxic and clastogenic activity of saponins extracted from Nauclea bark as assessed by the micronucleus and the comet assays in Chinese Hamster Ovary cells*. *Journal of Ethnopharmacology*, 2011. **137**(1): p. 176-83.
52. Cetinkaya, N., et al., *Quantification of applied dose in irradiated citrus fruits by DNA Comet Assay together with image analysis*. *Food Chemistry*, 2016. **192**: p. 370-3.
53. Jeung-Min Lee, et al., *Antioxidant and Alpha-Glucosidase Inhibitory Activity of Strychnos nux-vomica Extracts*. *Journal of Korean Society Food Science nutrition*, 2010. **9**(39): p. 1243-1248.
54. Tice R. and Vasquez M., *Protocol for the application of the pH>13 alkaline single cell gel (SCG) assay to the detection of DNA damage in mammalian cells*. ILS, 1999.
55. Olive, P.L. and J.P. Banath, *The comet assay: a method to measure DNA damage in individual cells*. *Nature Protocols*, 2006. **1**(1): p. 23-9.
56. Nandhakumar, S., et al., *Evaluation of DNA damage using single-cell gel electrophoresis (Comet Assay)*. *Journal of Pharmacology & Pharmacotherapeutics*, 2011. **2**(2): p. 107-111.
57. Alok Dhawan, et al., *Protocol for the single cell gel electrophoresis/comet assay for rapid genotoxicity assessment*, in *Developmental Toxicology Division Industrial Toxicology Research Centre*. India. p. 5.
58. ICH Harmonized Tripartite Guideline, ed. *Validation of Analytical Procedures: Text and Methodology Q2 (R1)*. 2005, European Union, Japan and USA.
59. Khandelwal, K.R., *Practical Pharmacognosy*. 2011, India: Nirali Prakashan.

60. สมพร (ภูதியานันต์) หิรัญรามเดช, ตำราการตรวจเอกลักษณ์พืชสมุนไพร เล่ม 5. 1986, Chiangmai: Faculty of pharmacy, Chiangmai University, Chiangmai.
61. Bhati, R., et al., *Strychnos nux-vomica seeds: Pharmacognostical standardization, extraction, and antidiabetic activity*. Journal of Ayurveda Integrative Medicine, 2012. **3**(2): p. 80-4.
62. Chinese pharmacopia commission, *Pharmacopoeia of the people's republic of China*. Vol. 1. 2010, Beijing, China: China medical science press.
63. The pharmacopoeia commission of PRC, *Pharmacopoeia of the people's republic of China*. Vol. 1. 1992: The pharmacopoeia commission of PRC.
64. Society of Japanese pharmacopoeia Yakuji Nippo, L., *The Pharmacopoeia of Japan*. Eighth edition. 1971: Society of Japanese pharmacopoeia Yakuji Nippo, LTD.
65. Services, U.S.D.o.H.a.H., *Guidance for Industry Bioanalytical Method Validation*. 2001: Drug Information Branch (HFD-210).
66. Hartmann, A., et al., *Recommendations for conducting the in vivo alkaline Comet assay*. Mutagenesis, 2003. **18**(1): p. 45-51.

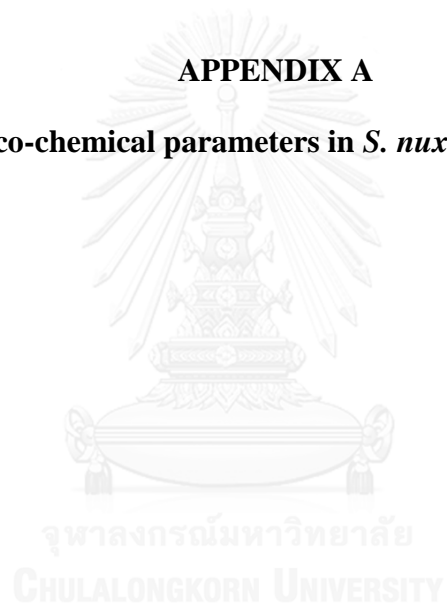
**APPENDICES**



จุฬาลงกรณ์มหาวิทยาลัย  
CHULALONGKORN UNIVERSITY

**APPENDIX A**

**Physico-chemical parameters in *S. nux-voimca* seeds**



**Table 25** The sources of 15 plant samples used in the study

<b>Source</b>	<b>Locality</b>
1	Phuket
2	Ranong
3	Phrae
4	Ubon Ratchathani
5	Bangkok
6	Surat Thani
7	Phra Nakhon Si Ayutthaya
8	Khonkaen
9	Songkhla
10	Buengkhan
11	Nakhon Pathom
12	Lumpang
13	Uttaradit
14	Nonthaburi
15	Lumpang 2

**Table 26** Physico-chemical properties of *Strychnos nux-vomica* dried seeds among 15 sources

Source	No.	Water content (% w/w)	Loss on drying (% w/w)	Total ash (% w/w)	Acid insoluble ash (% w/w)	Ethanol extractive value (% w/w)	Water extractive value (% w/w)
1	1	6.79	6.90	1.43	0.29	1.82	7.40
	2	6.99	7.60	1.33	0.24	1.83	6.13
	3	7.80	7.79	1.33	0.24	1.64	6.54
2	1	9.20	9.40	1.25	0.22	2.17	7.55
	2	10.40	9.21	1.34	0.22	3.24	9.37
	3	8.19	9.36	1.25	0.22	1.58	8.22
3	1	9.40	9.71	1.17	0.15	6.23	12.72
	2	8.99	9.74	1.15	0.19	5.64	13.21
	3	9.79	9.54	1.15	0.16	5.23	11.22
4	1	8.80	8.83	1.27	0.21	3.95	15.36
	2	8.40	8.97	1.28	0.18	4.15	15.02
	3	8.60	9.41	1.27	0.16	4.51	15.74
5	1	6.80	7.08	1.33	0.23	7.06	14.47
	2	8.60	7.95	1.35	0.19	7.26	13.34
	3	8.59	7.16	1.35	0.23	8.09	15.72
6	1	9.39	9.24	1.32	0.22	4.07	14.42
	2	9.40	9.31	1.31	0.22	3.62	13.93
	3	8.99	9.46	1.31	0.21	4.06	14.56
7	1	7.80	8.00	1.15	0.12	2.10	10.30
	2	7.00	7.54	1.16	0.13	2.22	11.58
	3	7.99	8.54	1.14	0.10	2.48	12.22
8	1	7.40	6.72	1.10	0.08	5.71	15.98
	2	6.99	6.72	1.13	0.09	5.73	16.28
	3	8.39	6.69	1.12	0.08	5.66	16.63
9	1	6.00	6.16	1.15	0.08	6.32	14.76
	2	6.99	6.28	1.15	0.09	5.98	15.53
	3	6.40	6.21	1.14	0.08	6.74	16.60
10	1	8.39	10.29	1.24	0.14	2.17	13.83
	2	8.39	10.39	1.22	0.15	2.30	16.63
	3	8.00	10.23	1.26	0.17	2.52	15.58
11	1	7.40	9.41	1.09	0.09	4.72	15.40
	2	7.99	9.35	1.10	0.10	4.65	16.30
	3	8.39	9.52	1.09	0.09	4.72	15.70
12	1	7.79	10.00	1.11	0.12	3.21	11.85
	2	7.99	10.14	1.11	0.09	3.41	11.32
	3	8.79	9.90	1.14	0.12	3.38	12.34
13	1	5.80	10.53	1.13	0.10	1.43	11.43
	2	7.00	10.54	1.12	0.15	1.60	10.38
	3	7.40	10.48	1.14	0.11	1.51	11.01
14	1	8.60	9.65	1.12	0.10	4.60	15.60
	2	7.80	9.45	1.24	0.13	4.91	15.86
	3	8.40	9.52	1.12	0.11	4.68	16.21
15	1	8.00	8.69	1.21	0.18	2.10	12.36
	2	8.59	9.33	1.13	0.14	2.13	11.93
	3	8.60	9.02	1.18	0.14	2.24	11.98
<b>Grand mean</b>		<b>8.08</b>	<b>8.80</b>	<b>1.20</b>	<b>0.15</b>	<b>3.90</b>	<b>13.12</b>
<b>Pooled SD</b>		<b>0.60</b>	<b>0.25</b>	<b>0.03</b>	<b>0.02</b>	<b>0.33</b>	<b>0.77</b>
<b>Grand mean</b>				$\frac{\bar{x}_1 n_1 + \bar{x}_2 n_2 + \dots + \bar{x}_k n_k}{n_1 + n_2 + \dots + n_k}$			
<b>Pooled SD</b>				$\sqrt{\frac{\sum (n_{1,k-1}) \times SD_{1,k}^2}{n_1 + n_2 + \dots + n_k - k}}$			



## **APPENDIX B**

**Quantitative analysis of strychnine and brucine contents in *S. nux-vomica* seeds**



**Table 27** The strychnine content in *S. nux-vomica* dried crude drug from 15 sources by TLC image analysis

Source	Ethanolic extract (g/100g of dried crude drug)	Strychnine in ethanolic extract (g/g extract)				Strychnine in <i>S. nux-vomica</i> seeds (g/100g of dried crude drug)
		1	2	3	Mean	
1	6.56	0.15	0.14	0.15	0.15	0.96
2	10.71	0.16	0.12	0.13	0.14	1.47
3	10.47	0.15	0.12	0.11	0.13	1.33
4	9.79	0.16	0.12	0.11	0.13	1.29
5	14.54	0.17	0.13	0.13	0.14	2.08
6	7.89	0.15	0.13	0.12	0.14	1.07
7	4.88	0.14	0.12	0.12	0.13	0.62
8	12.52	0.18	0.14	0.14	0.15	1.87
9	12.67	0.20	0.13	0.13	0.15	1.92
10	5.19	0.15	0.11	0.11	0.12	0.64
11	8.40	0.14	0.12	0.11	0.13	1.06
12	6.70	0.14	0.12	0.10	0.12	0.82
13	4.82	0.08	0.09	0.08	0.08	0.39
14	6.51	0.09	0.08	0.08	0.09	0.56
15	6.56	0.07	0.07	0.07	0.07	0.34
<b>Mean ± SD</b>						<b>1.09 ± 0.56</b>

**Table 28** The brucine content in *S. nux-vomica* dried crude drug from 15 sources by TLC image analysis

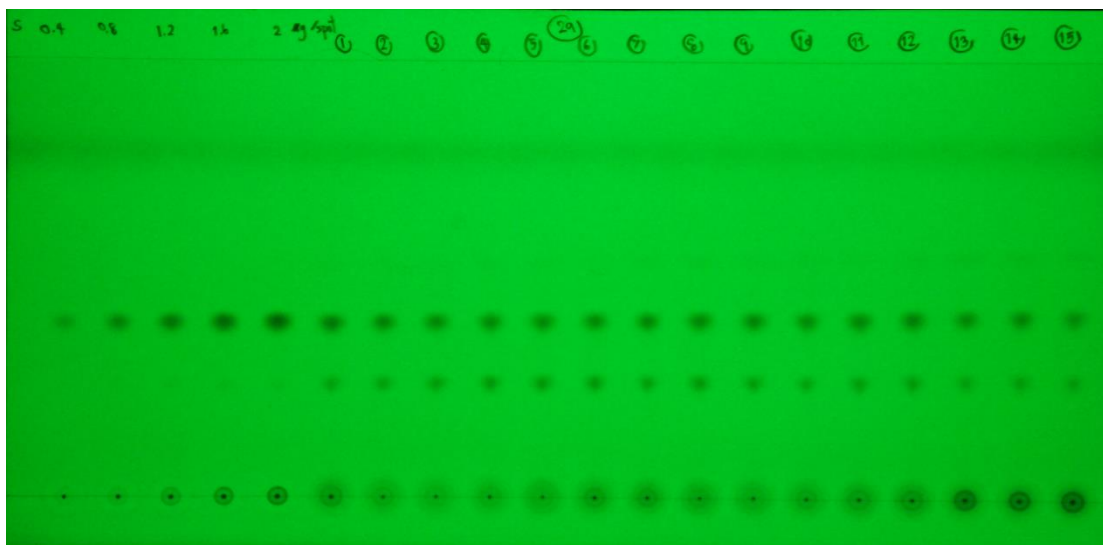
Source	Ethanolic extract (g/100g of dried crude drug)	Brucine in ethanolic extract (g/g extract)				Brucine in <i>S.</i> <i>nux-vomica</i> seeds (g/100g of dried crude drug)
		1	2	3	Mean	
1	6.56	0.05	0.05	0.05	0.05	0.32
2	10.71	0.05	0.06	0.06	0.05	0.59
3	10.47	0.07	0.06	0.07	0.07	0.68
4	9.79	0.07	0.07	0.07	0.07	0.68
5	14.54	0.07	0.08	0.08	0.08	1.11
6	7.89	0.07	0.07	0.08	0.07	0.57
7	4.88	0.04	0.05	0.05	0.05	0.23
8	12.52	0.06	0.07	0.07	0.07	0.85
9	12.67	0.06	0.06	0.07	0.07	0.84
10	5.19	0.04	0.05	0.05	0.05	0.24
11	8.40	0.04	0.05	0.05	0.05	0.39
12	6.70	0.04	0.04	0.04	0.04	0.27
13	4.82	0.03	0.03	0.03	0.03	0.14
14	6.51	0.03	0.03	0.03	0.03	0.18
15	6.56	0.02	0.03	0.02	0.03	0.13
<b>Mean ± SD</b>						<b>0.48 ± 0.30</b>

**Table 29** The strychnine content in *S. nux-vomica* dried crude drug from 15 sources by TLC densitometry

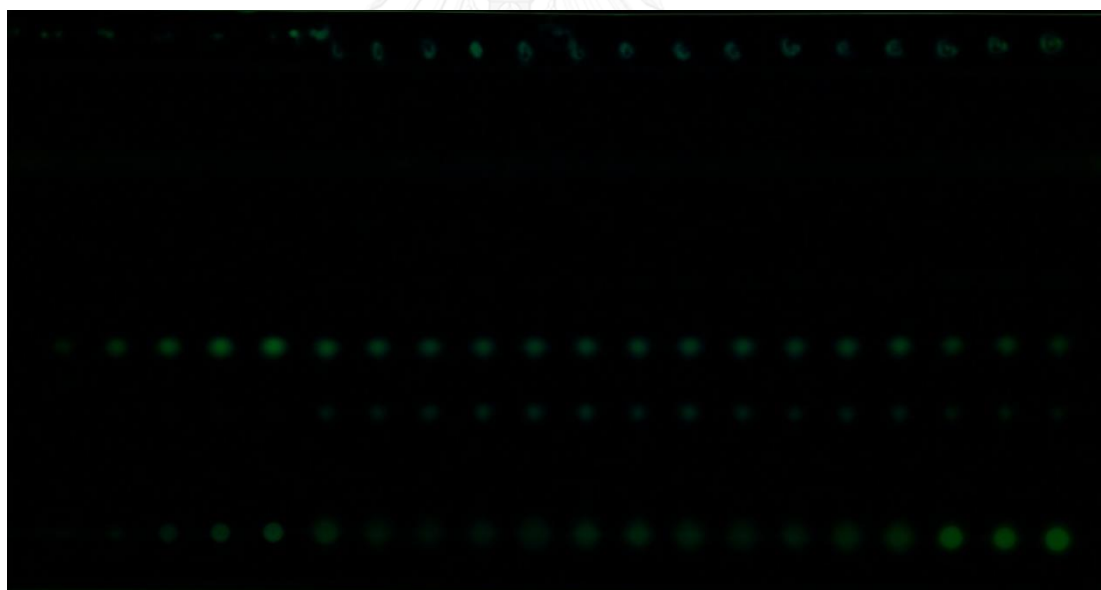
Source	Ethanolic extract (g/100g of dried crude drug)	Strychnine in ethanolic extract (g/g extract)				Strychnine in <i>S. nux-vomica</i> seeds (g/100g of dried crude drug)
		1	2	3	Mean	
1	6.56	0.15	0.14	0.14	0.14	0.93
2	10.71	0.15	0.12	0.12	0.13	1.38
3	10.47	0.14	0.11	0.10	0.12	1.21
4	9.79	0.15	0.11	0.11	0.12	1.20
5	14.54	0.16	0.12	0.12	0.13	1.92
6	7.89	0.15	0.12	0.12	0.13	1.01
7	4.88	0.12	0.11	0.11	0.12	0.56
8	12.52	0.17	0.12	0.13	0.14	1.73
9	12.67	0.18	0.12	0.12	0.14	1.78
10	5.19	0.13	0.10	0.10	0.11	0.59
11	8.40	0.13	0.12	0.11	0.12	0.99
12	6.70	0.13	0.12	0.11	0.12	0.81
13	4.82	0.08	0.09	0.07	0.08	0.39
14	6.51	0.09	0.09	0.09	0.09	0.58
15	6.56	0.15	0.14	0.14	0.14	0.93
<b>Mean ± SD</b>						<b>1.03 ± 0.51</b>

**Table 30** The brucine content in *S. nux-vomica* dried crude drug from 15 sources by TLC densitometry

Source	Ethanolic extract (g/100g of dried crude drug)	Brucine in ethanolic extract (g/g extract)				Brucine in <i>S.</i> <i>nux-vomica</i> seeds (g/100g of dried crude drug)
		1	2	3	Mean	
1	6.56	0.04	0.05	0.05	0.05	0.30
2	10.71	0.05	0.05	0.05	0.05	0.56
3	10.47	0.06	0.06	0.06	0.06	0.65
4	9.79	0.06	0.06	0.07	0.07	0.64
5	14.54	0.07	0.07	0.07	0.07	1.03
6	7.89	0.06	0.07	0.07	0.07	0.52
7	4.88	0.04	0.05	0.05	0.04	0.22
8	12.52	0.06	0.06	0.07	0.06	0.79
9	12.67	0.06	0.06	0.06	0.06	0.80
10	5.19	0.04	0.05	0.05	0.04	0.23
11	8.40	0.04	0.05	0.05	0.05	0.38
12	6.70	0.04	0.04	0.04	0.04	0.29
13	4.82	0.03	0.03	0.03	0.03	0.13
14	6.51	0.03	0.03	0.03	0.03	0.19
15	6.56	0.02	0.03	0.02	0.03	0.13
<b>Mean ± SD</b>						<b>0.46 ± 0.28</b>

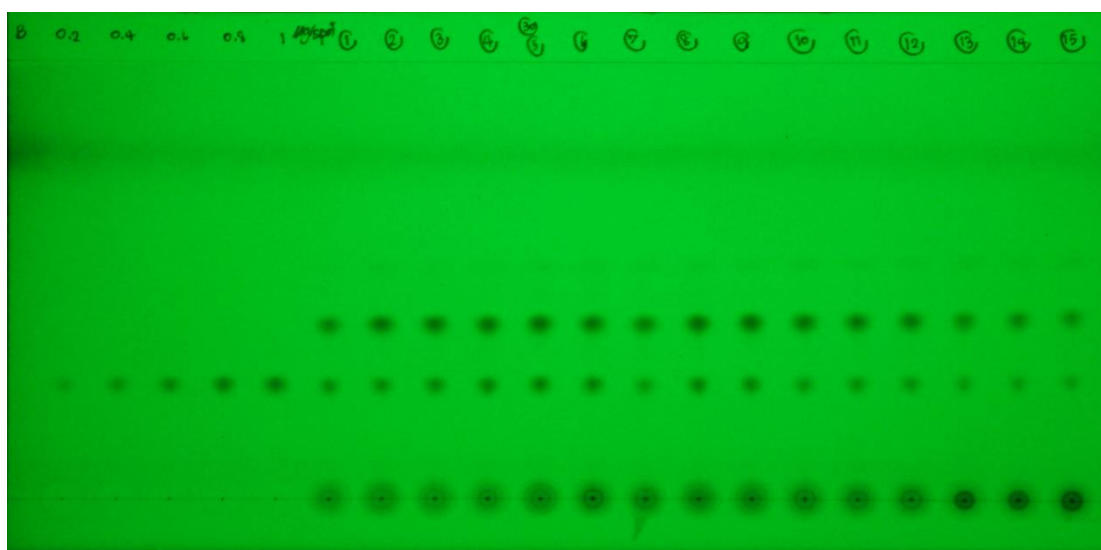


(A)

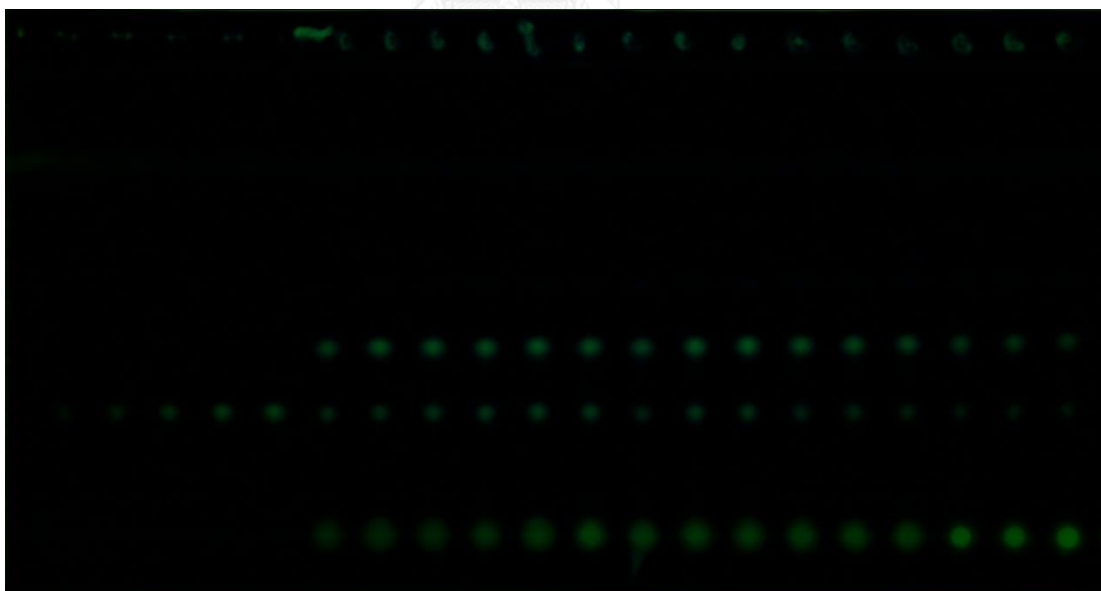


(B)

**Figure 18** TLC chromatograms of 15 samples and standard strychnine (A) under 254 nm, with invert and subtracts background by Image J software (B)

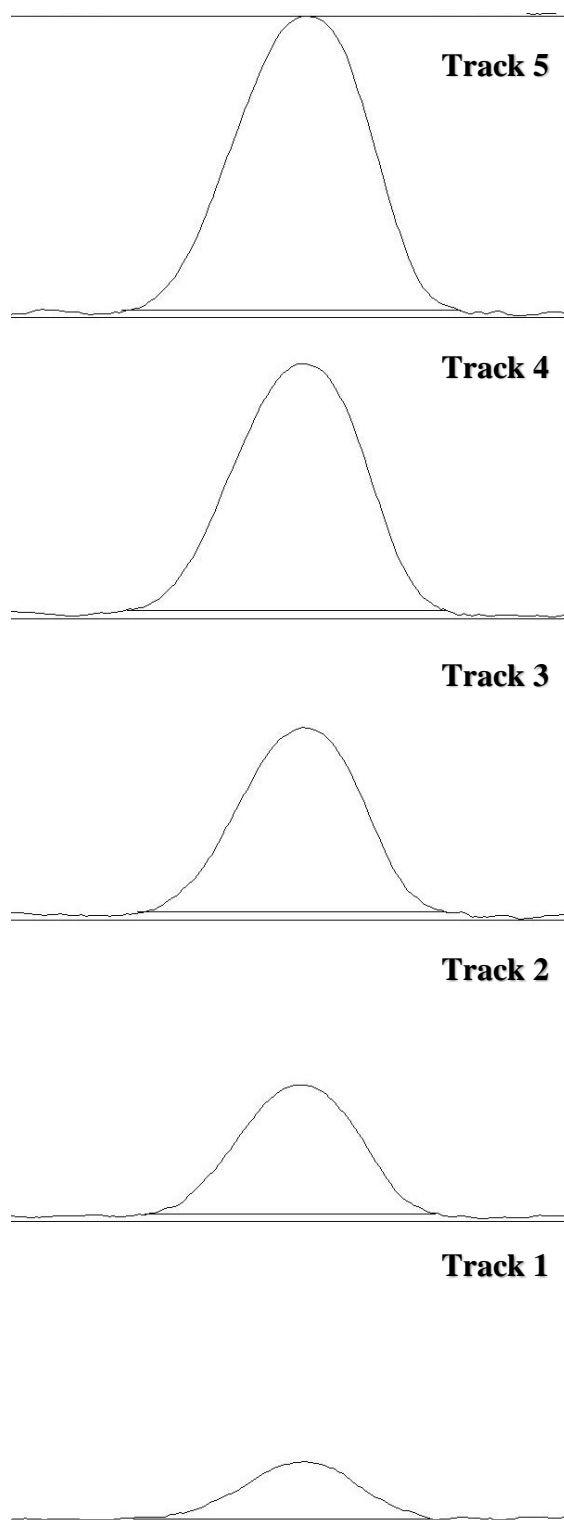


(A)



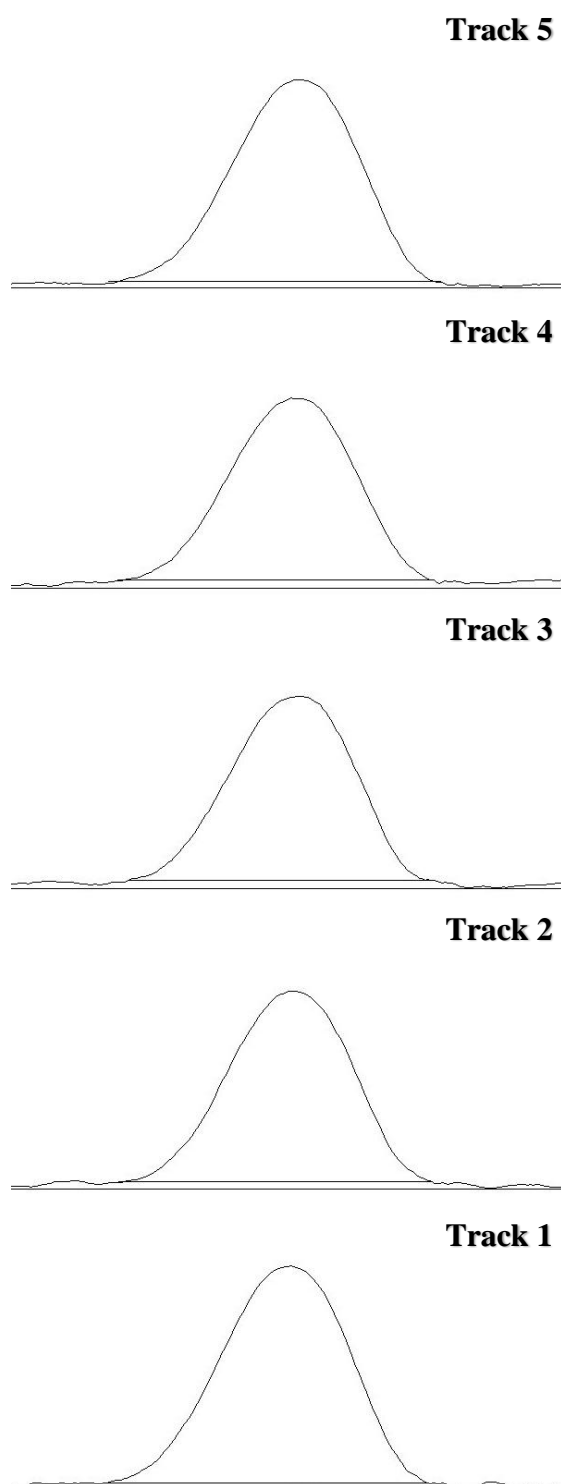
(B)

**Figure 19** TLC chromatograms of 15 samples and standard brucine (A) under 254 nm, with invert and subtracts background by Image J software (B)

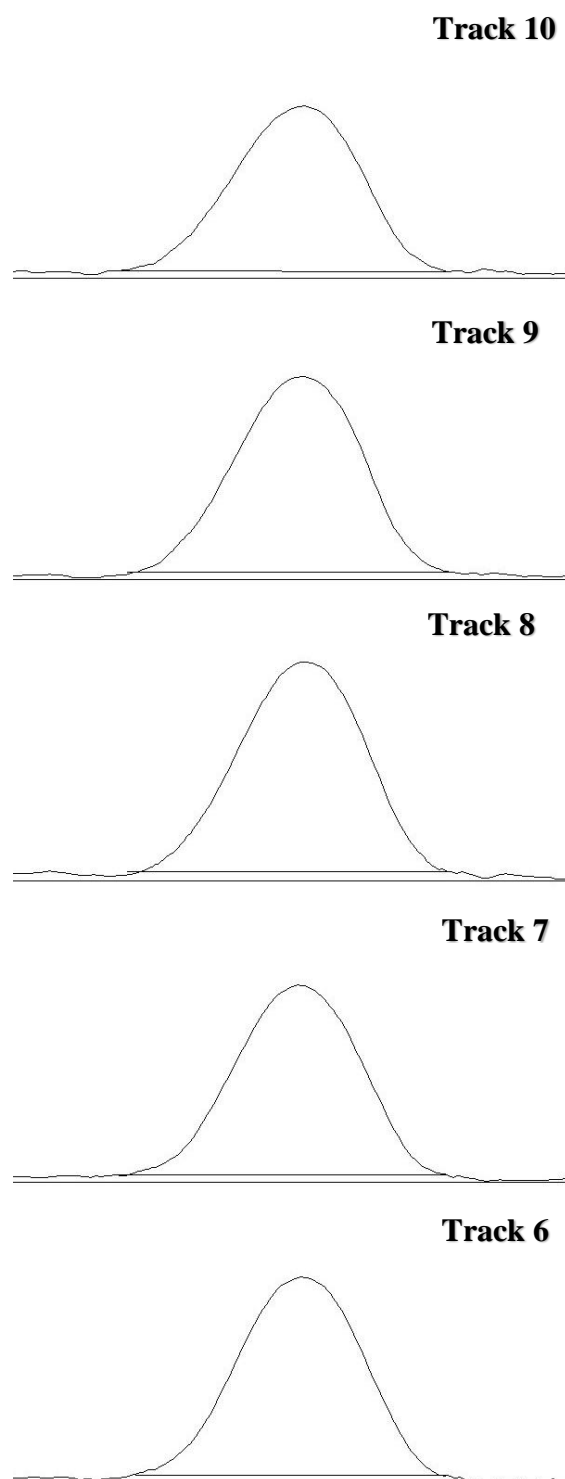


**Figure 20** TLC chromatogram of strychnine standard No.1-5 by TLC image analysis by Image J software

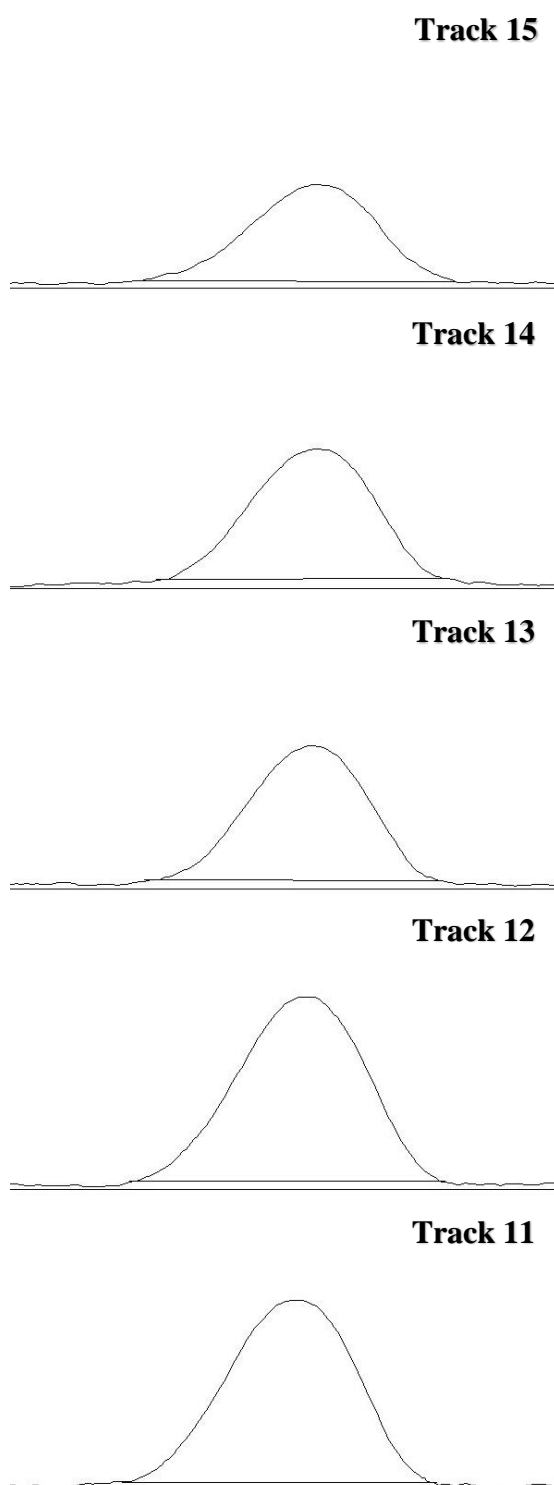




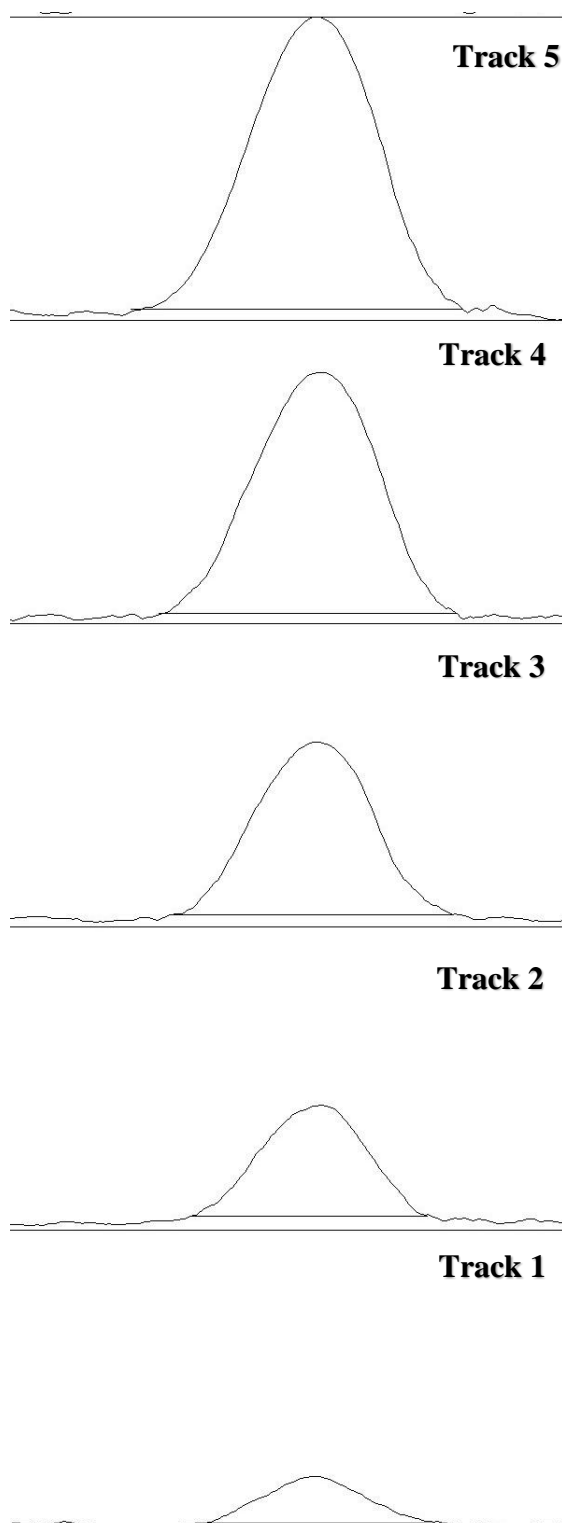
**Figure 21** TLC chromatogram of sample No.1-5 by TLC image analysis by Image J software



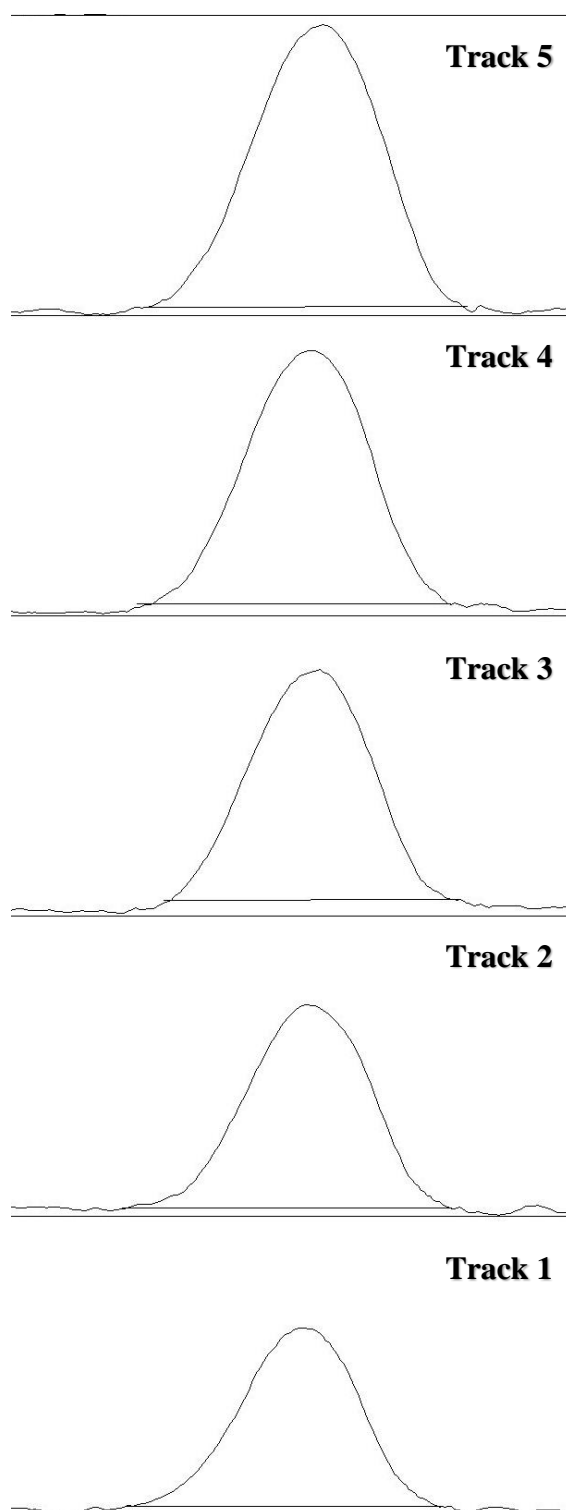
**Figure 22** TLC chromatogram of sample No.6-10 by TLC image analysis by Image J software



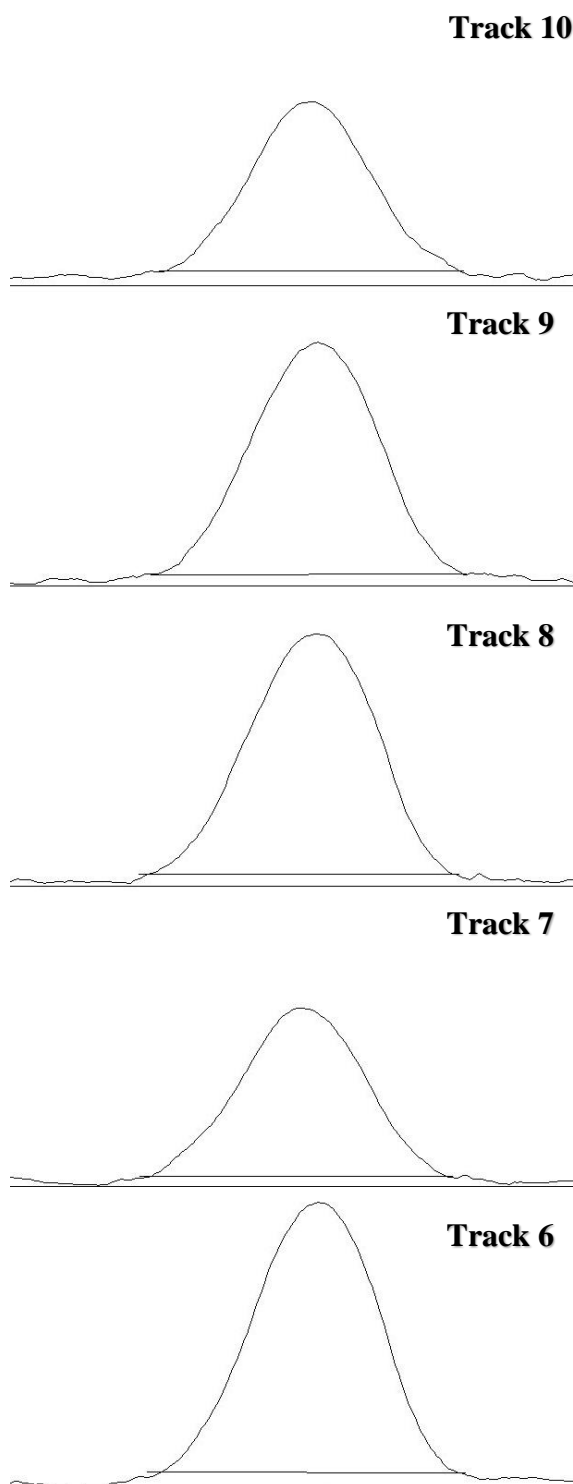
**Figure 23** TLC chromatogram of sample No.11-15 by TLC image analysis by Image J software



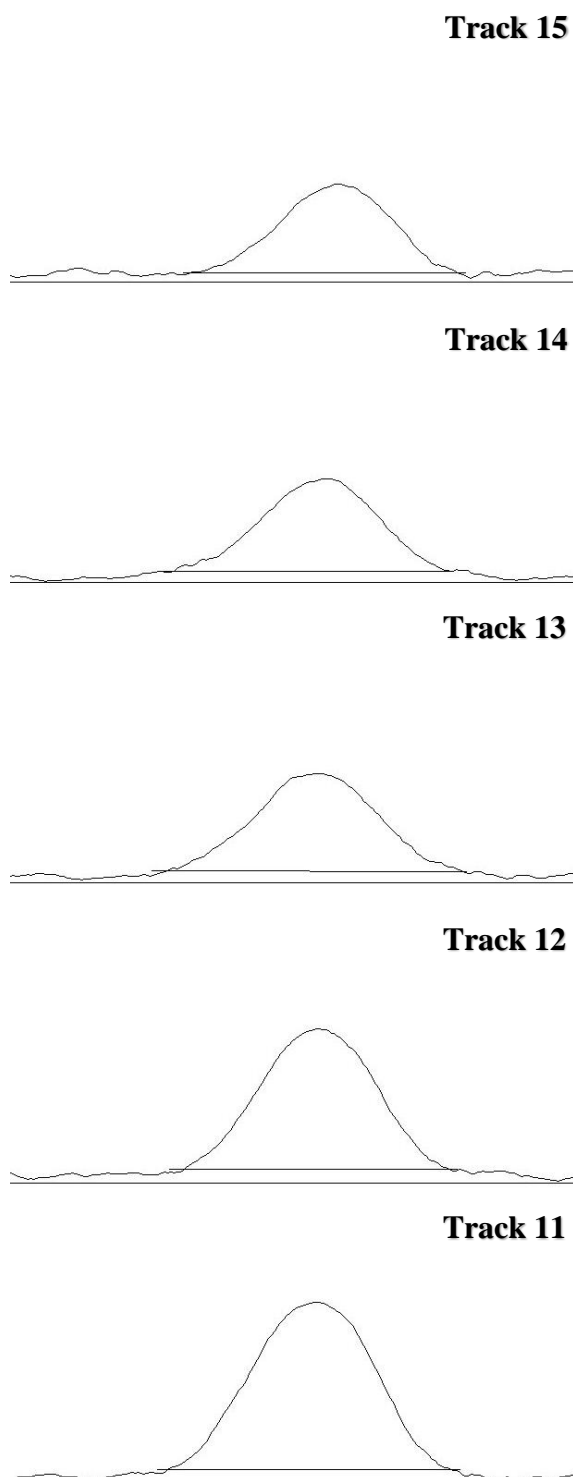
**Figure 24** TLC chromatogram of brucine standard No.1-5 by TLC image analysis by Image J software



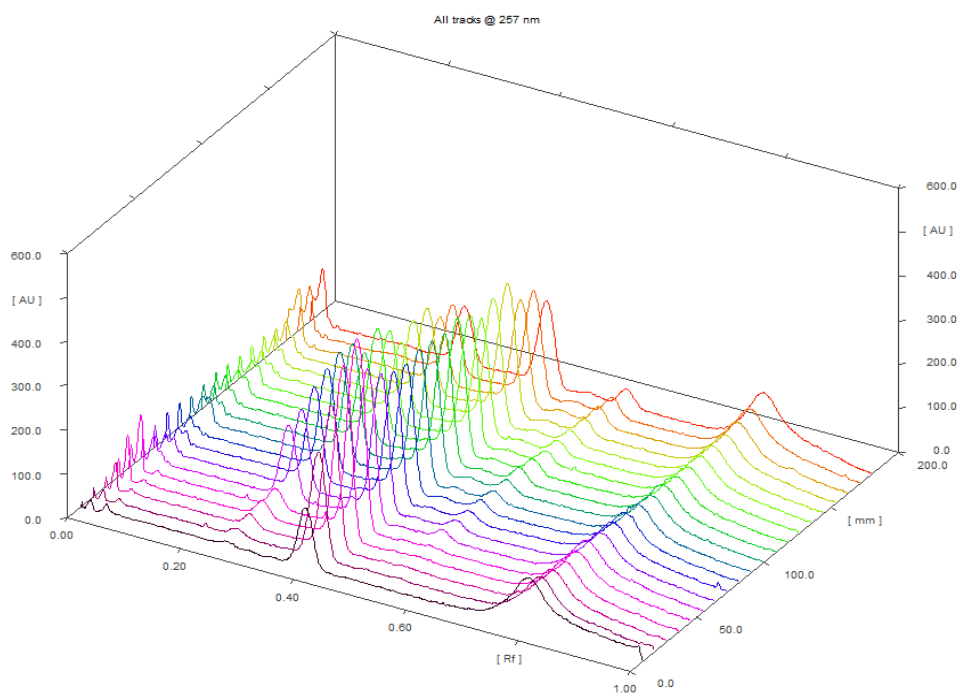
**Figure 25** TLC chromatogram of sample No.1-5 by TLC image analysis by Image J software



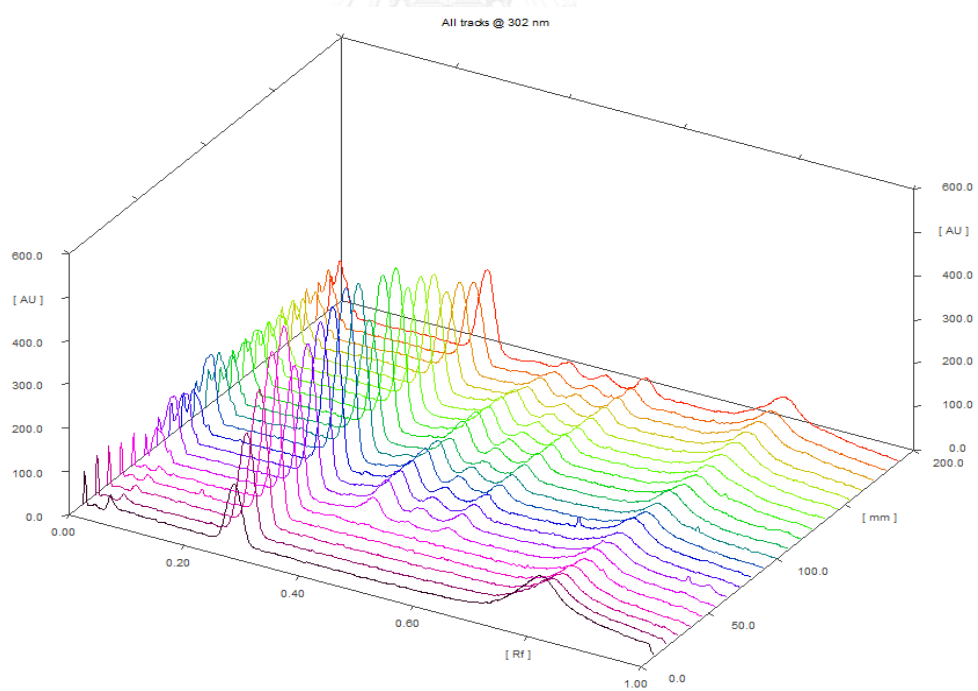
**Figure 26** TLC chromatogram of sample No.6-10 by TLC image analysis by Image J software



**Figure 27** TLC chromatogram of sample No.11-15 by TLC image analysis by Image J software



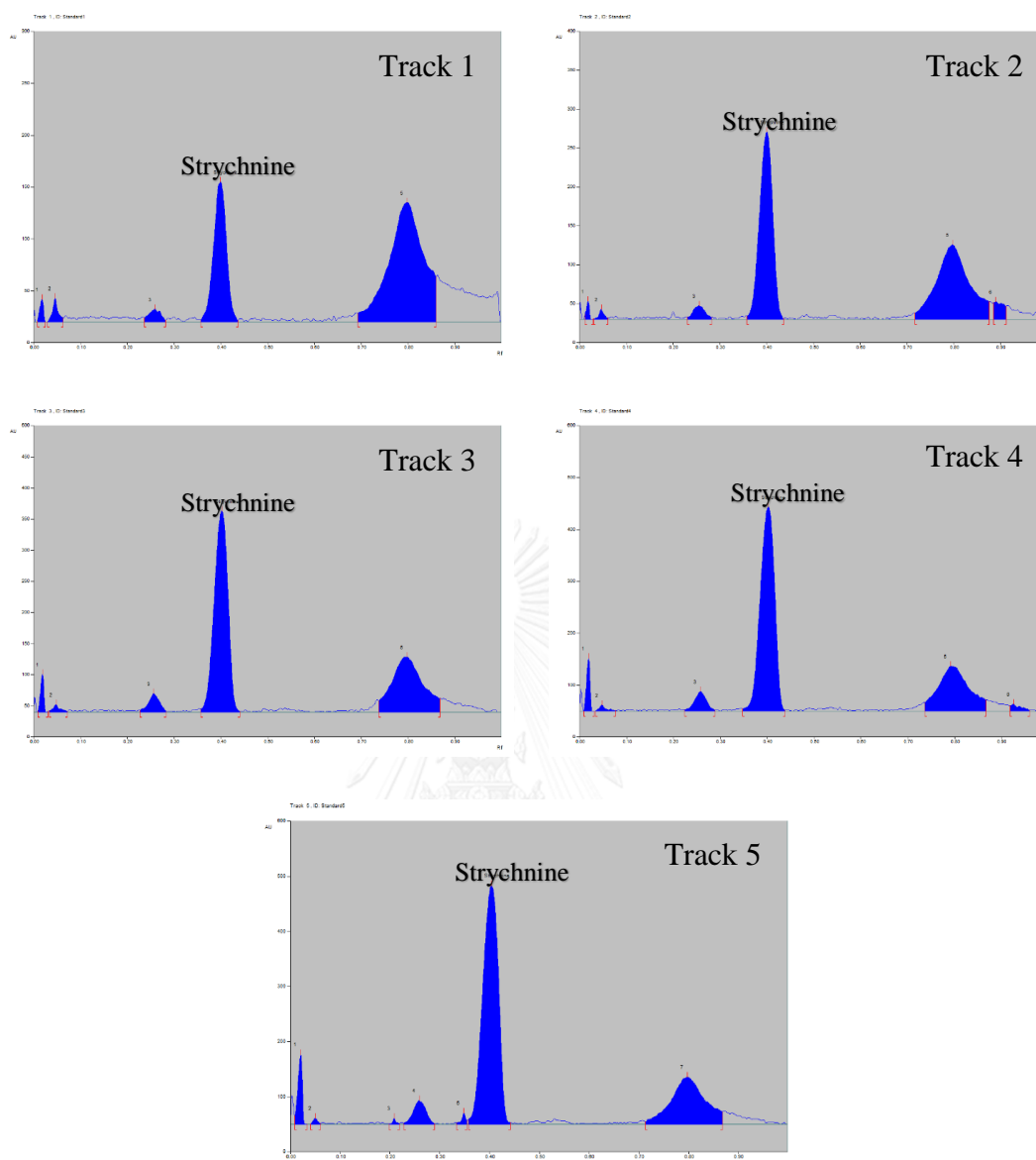
(A)



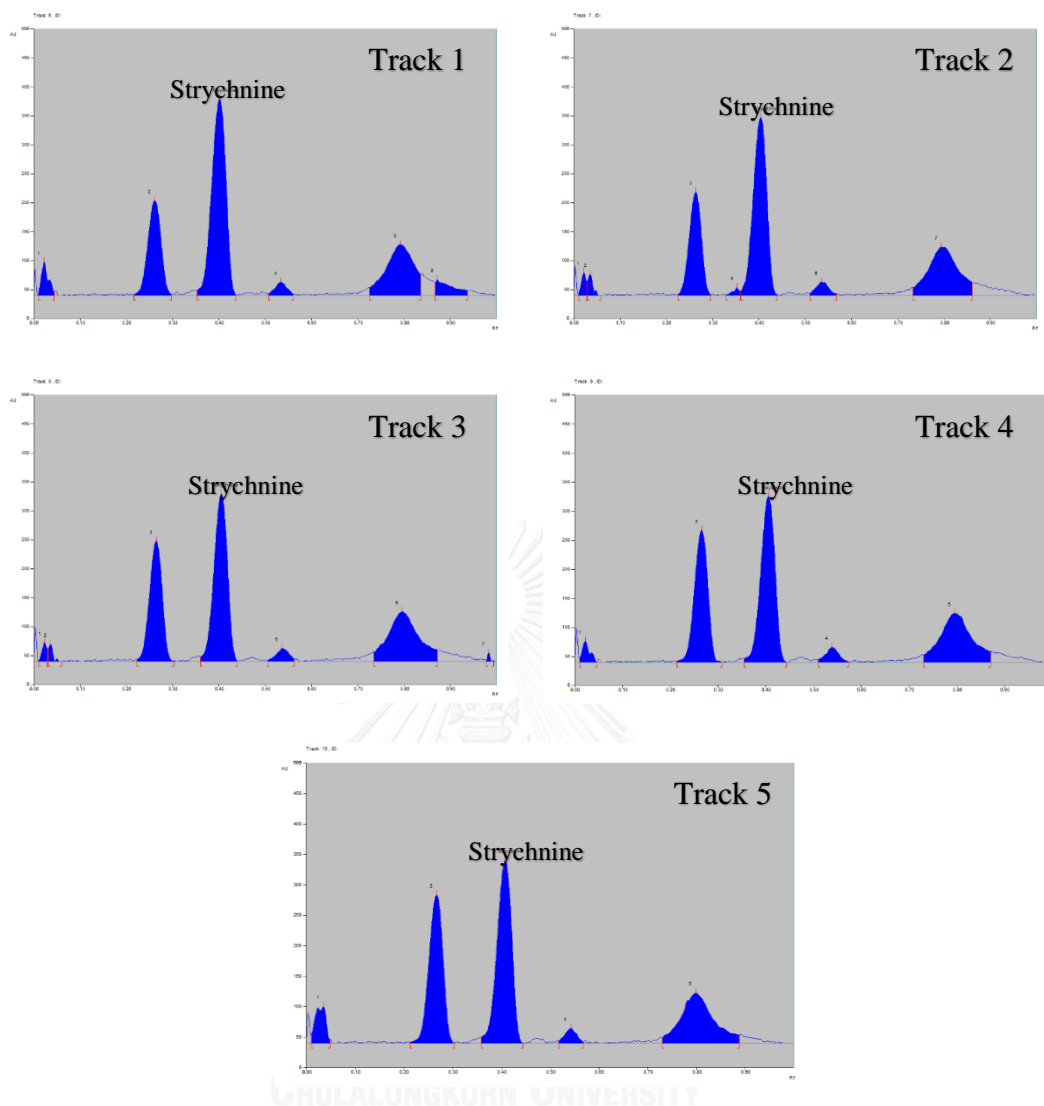
(B)

**Figure 28** TLC densitograms of 15 samples and standard strychnine (A) and brucine (B) under 257 and 302 nm respectively

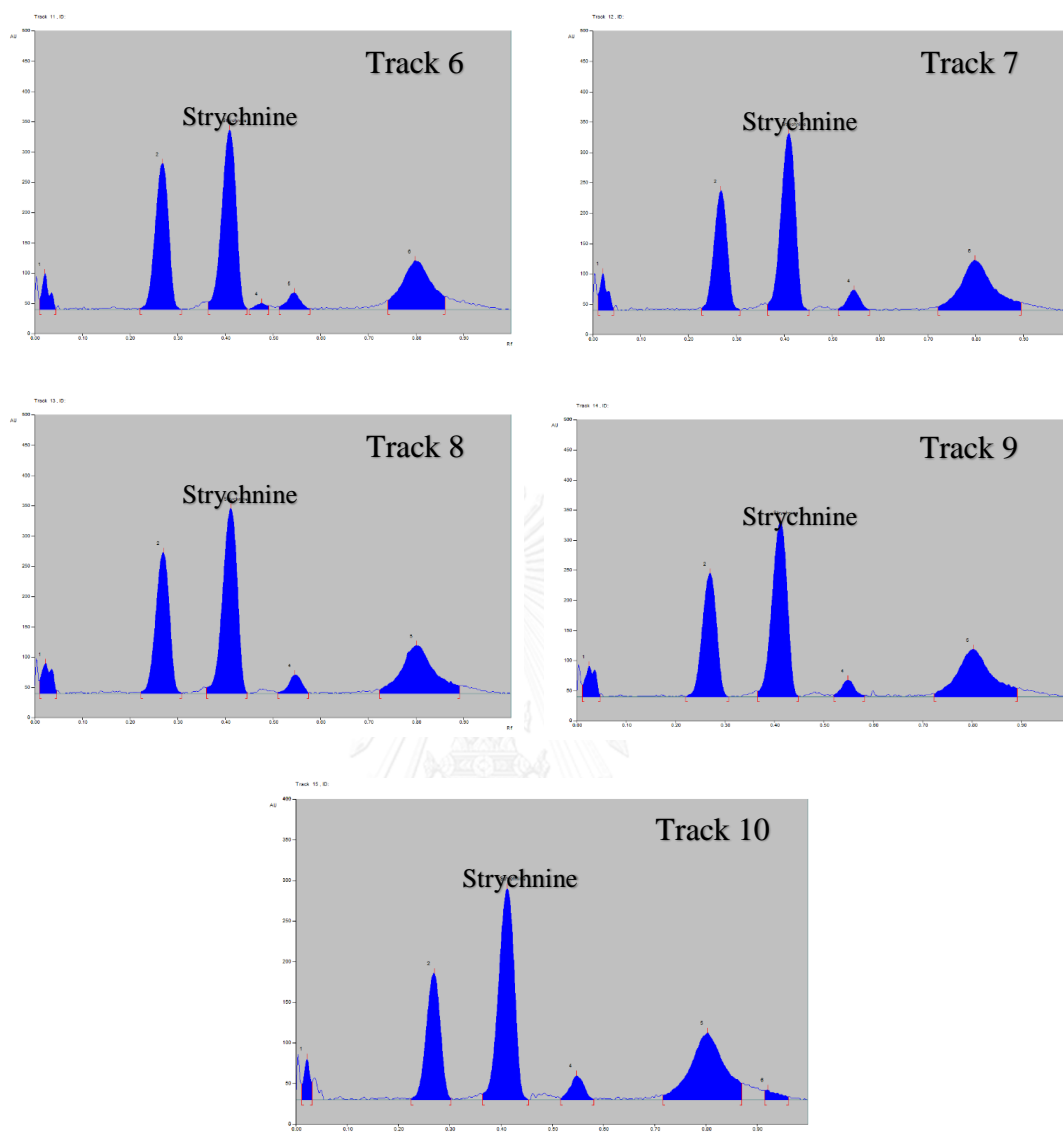




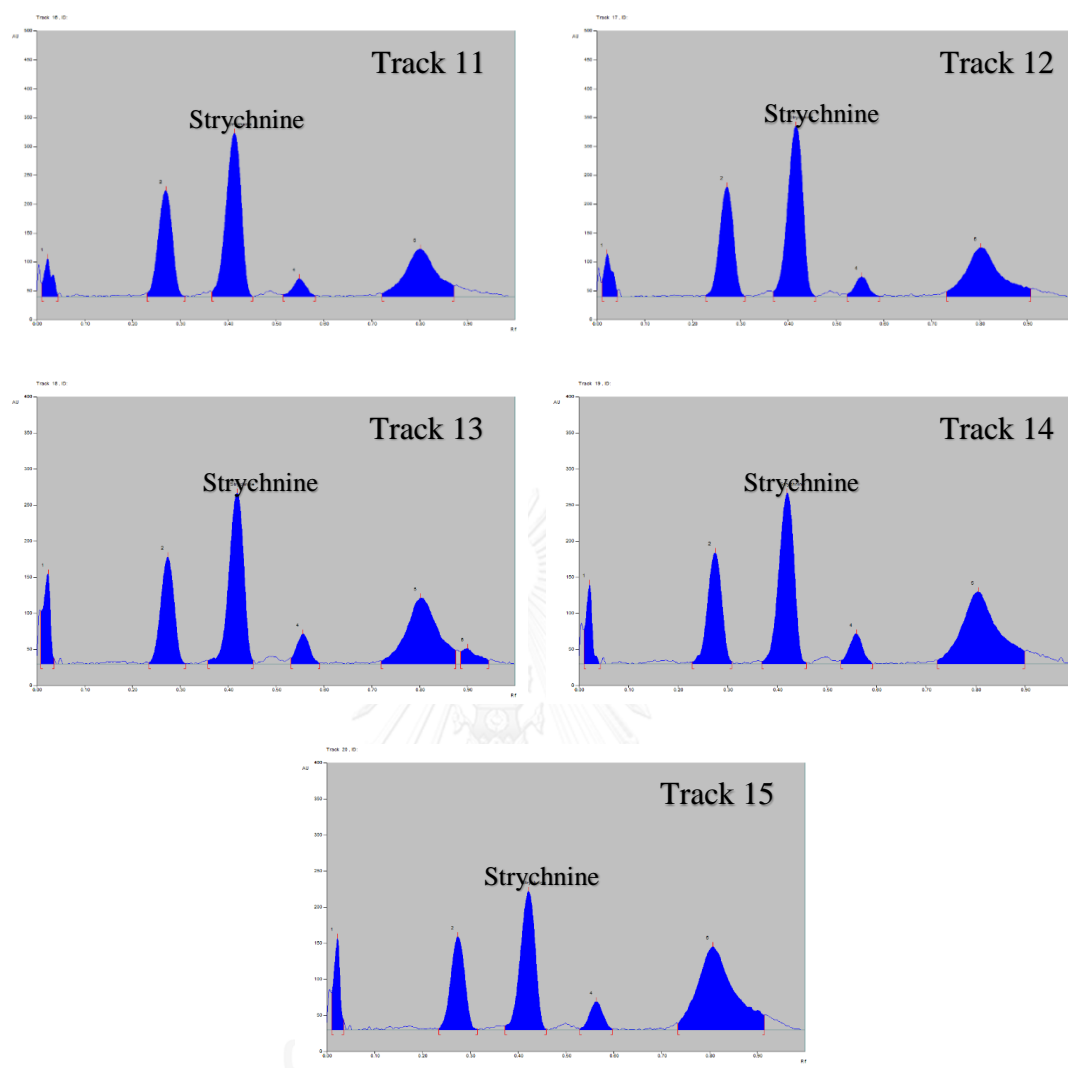
**Figure 29** TLC densitogram of strychnine standard No.1-5 by TLC densitometry



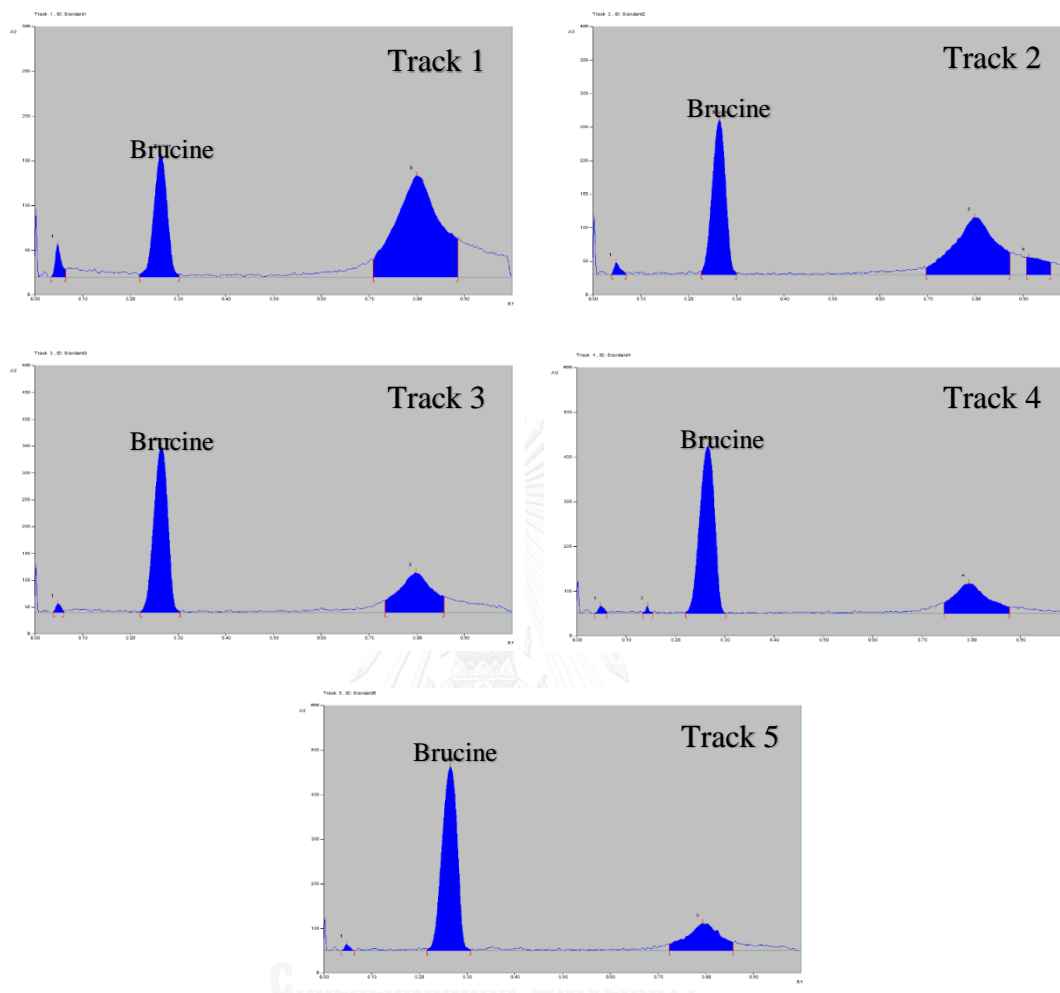
**Figure 30** TLC densitogram of sample No.1-5 by TLC densitometry



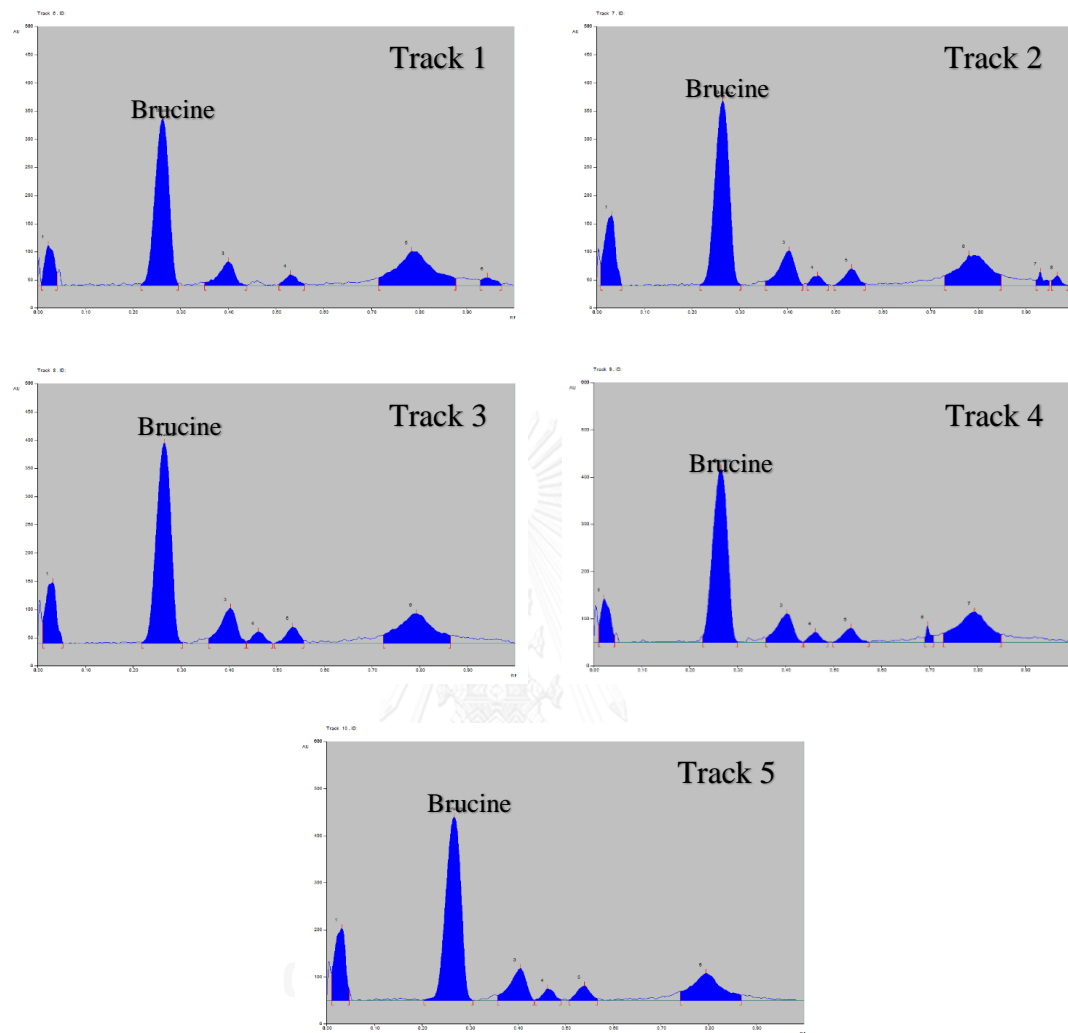
**Figure 31** TLC densitogram of sample No.6-10 by TLC densitometry



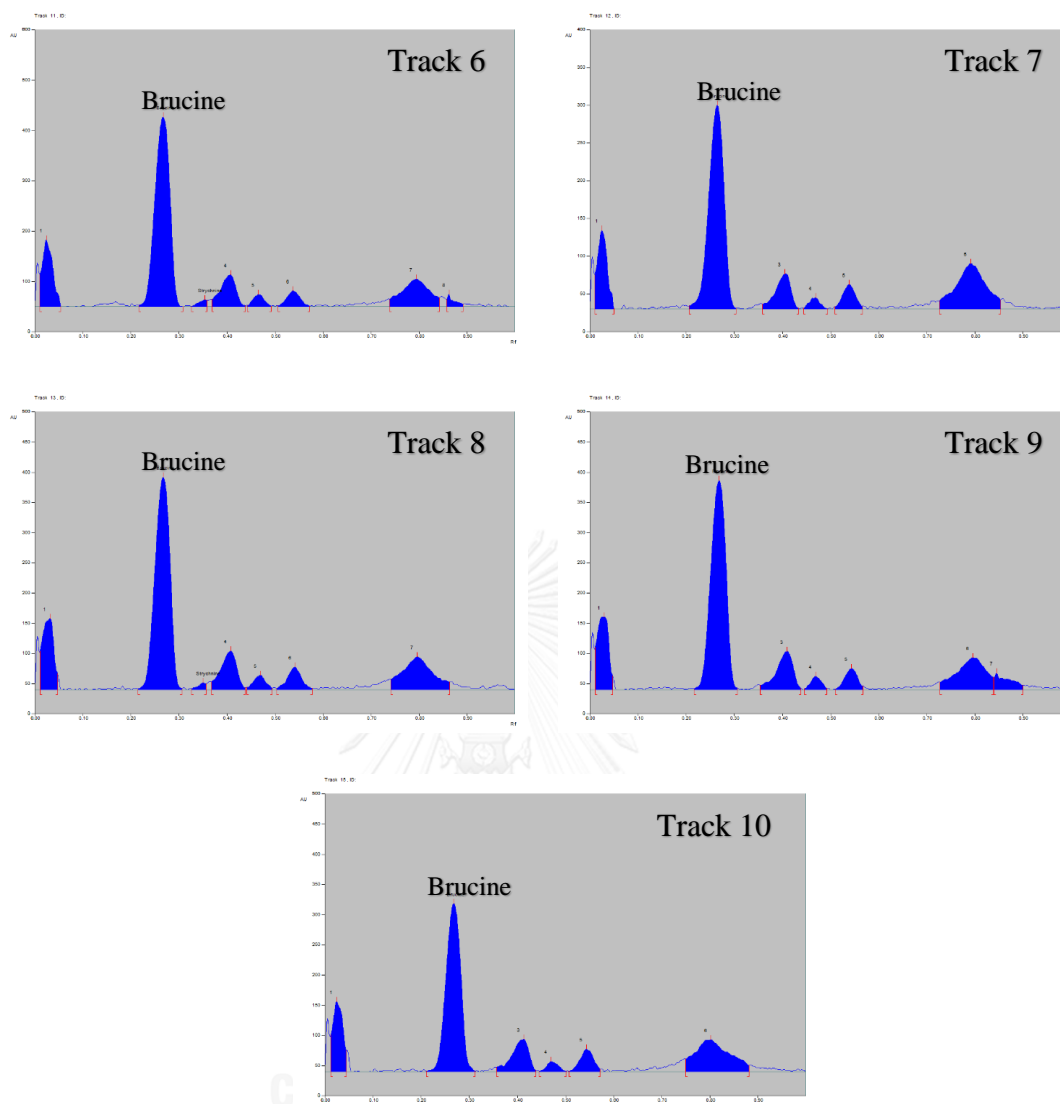
**Figure 32** TLC densitogram of sample No.11-15 by TLC densitometry



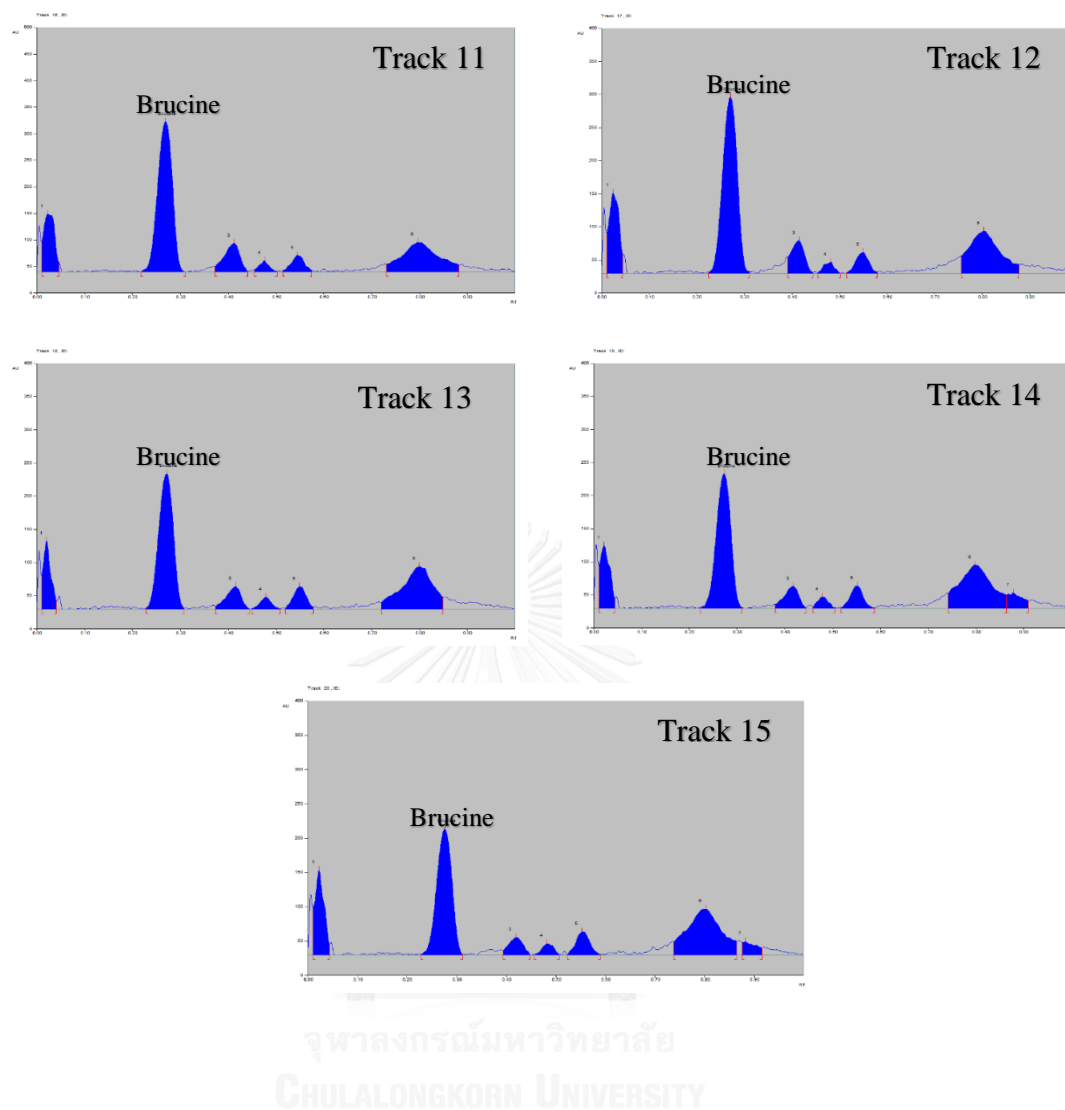
**Figure 33** TLC densitogram of brucine standard No.1-5 by TLC densitometry



**Figure 34** TLC densitogram of sample No.1-5 by TLC densitometry



**Figure 35** TLC densitogram of sample No.6-10 by TLC densitometry



**Figure 36** TLC densitogram of sample No.11-15 by TLC densitometry





**APPENDIX C**

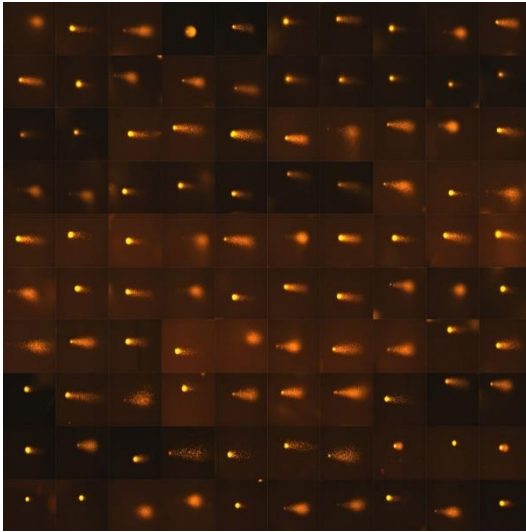
**DNA damage (comet assay) analysis**

จุฬาลงกรณ์มหาวิทยาลัย  
CHULALONGKORN UNIVERSITY

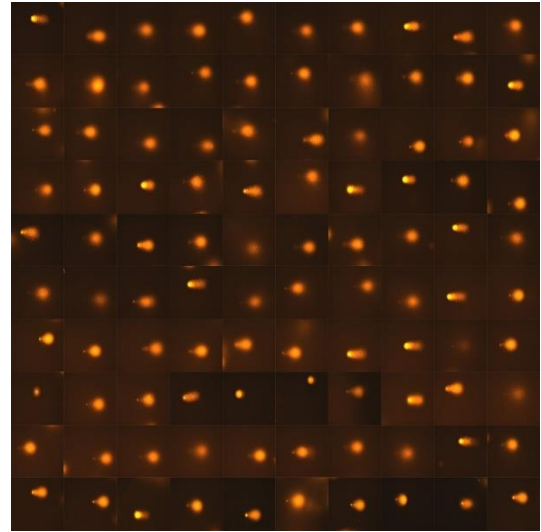
**Table 31** The total scores of DNA damage between 0- 400 arbitrary unit of strychnine, brucine standard and *S. nux-vomica* seeds extract

Concentrations	No.	Strychnine	Brucine	Extract	H <sub>2</sub> O <sub>2</sub> (+)	PBS (-)
<b>25µg/ml</b>	1	298	266	215	395	-
	2	276	252	192	396	-
	3	298	218	204	399	-
	<b>Mean</b>	<b>290.67</b>	<b>245.33</b>	<b>203.67</b>	<b>396.67</b>	<b>-</b>
	<b>SD</b>	<b>12.70</b>	<b>24.68</b>	<b>11.50</b>	<b>2.08</b>	<b>-</b>
<b>50µg/ml</b>	1	374	359	343	-	-
	2	371	360	344	-	-
	3	392	355	317	-	-
	<b>Mean</b>	<b>379.00</b>	<b>358.00</b>	<b>334.67</b>	<b>-</b>	<b>-</b>
	<b>SD</b>	<b>1.36</b>	<b>2.65</b>	<b>15.31</b>	<b>-</b>	<b>-</b>
<b>100µg/ml</b>	1	388	393	387	-	128
	2	400	383	396	-	118
	3	388	399	392	-	148
	<b>Mean</b>	<b>392.00</b>	<b>391.67</b>	<b>391.67</b>	<b>-</b>	<b>131.33</b>
	<b>SD</b>	<b>6.93</b>	<b>8.08</b>	<b>4.51</b>	<b>-</b>	<b>15.28</b>

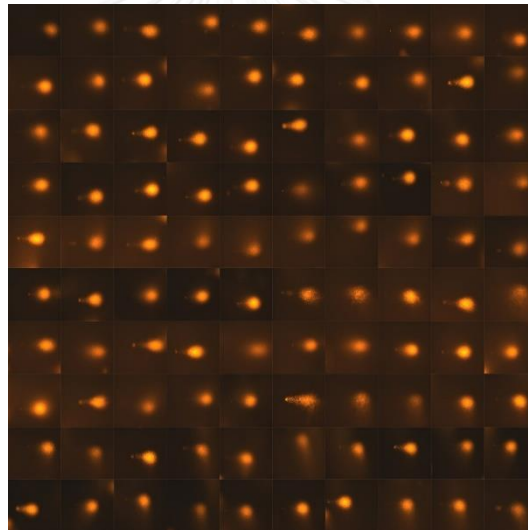
The total score was between 0 (100 cells presenting no damage) and 400 (all cells presenting damage class 4)



**Figure 38.1** Strychnine – 25 µg/ml

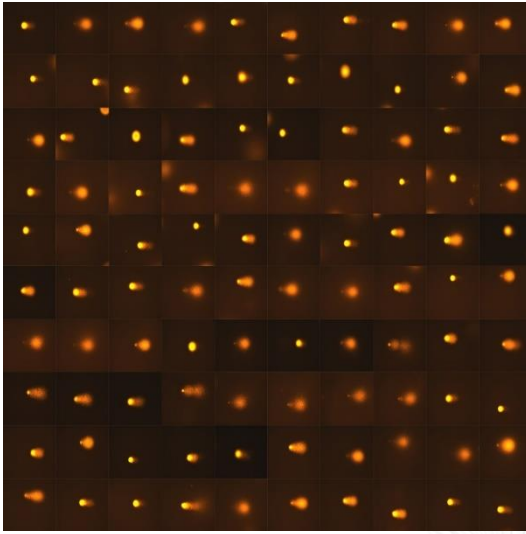


**Figure 38.2** Strychnine – 50 µg/ml

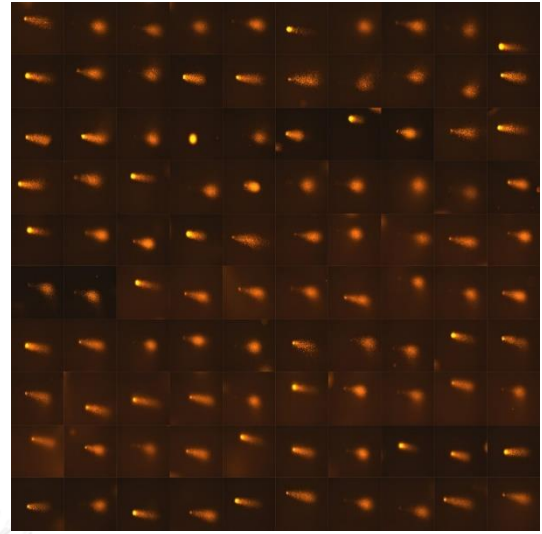


**Figure 38.3** Strychnine - 100 µg/ml

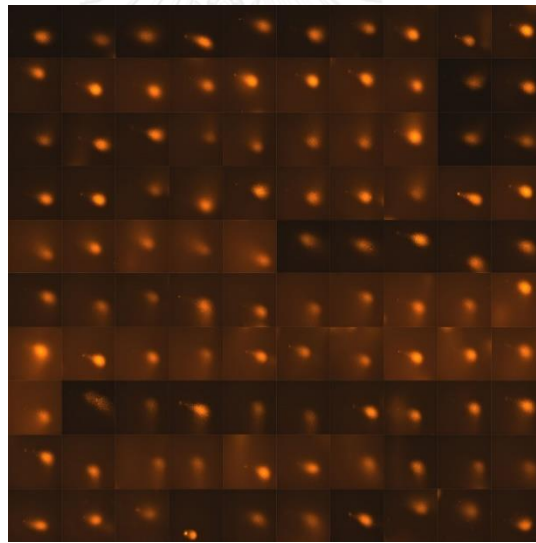
**Figure 37** The 100 images of DNA damaged in human lymphocyte cells by visual scoring under the magnification of 40



**Figure 39.1** Brucine - 25 µg/ml

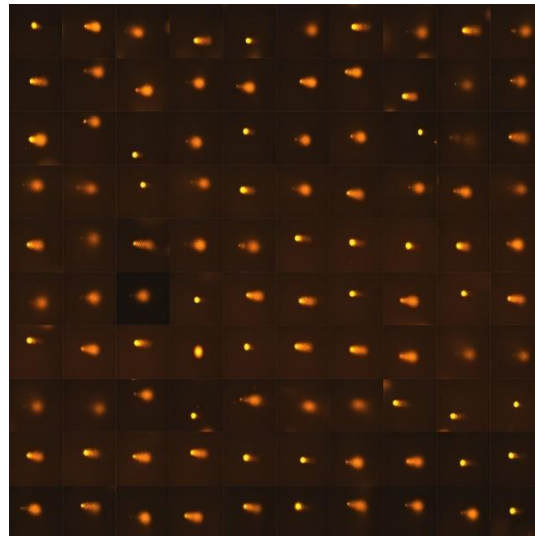
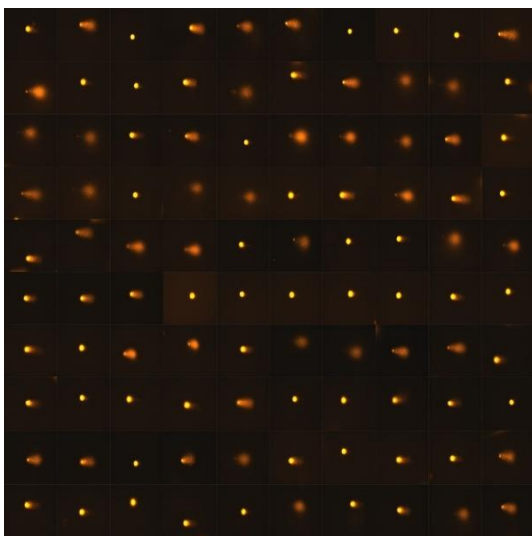


**Figure 39.2** Brucine - 50 µg/ml

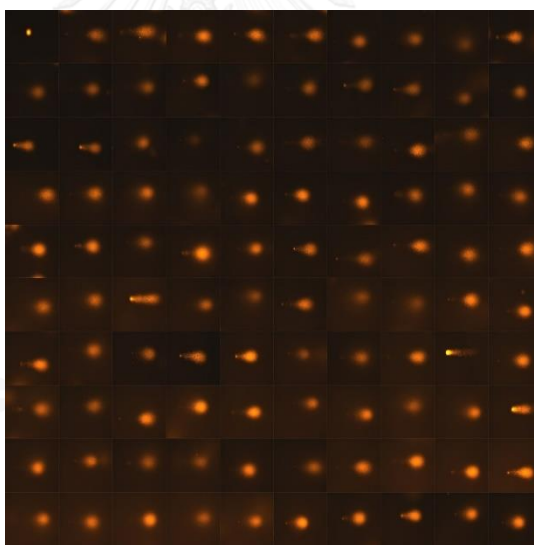


**Figure 39.3** Brucine - 100 µg/ml

**Figure 38** The 100 images of DNA damaged in human lymphocyte cells by visual scoring under the magnification of 400X (Cont.)

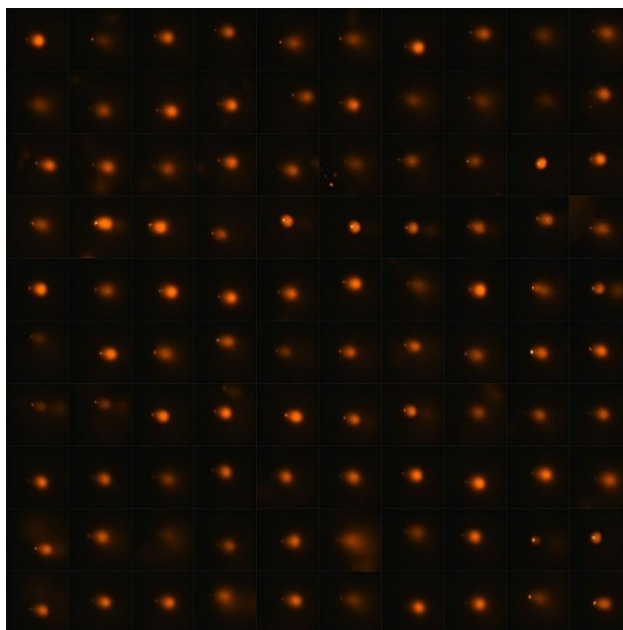


**Figure 40.1** *S. nux-vomica* seeds -25 µg/ml **Figure 40.2** *S. nux-vomica* seeds -50 µg/ml

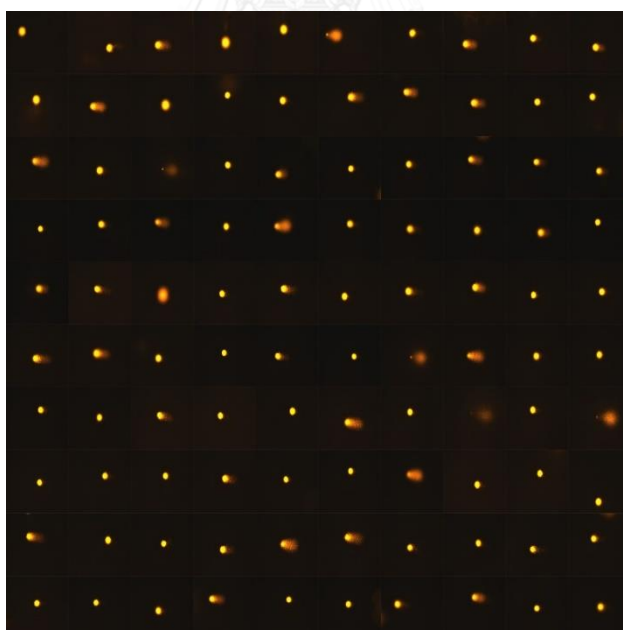


**Figure 40.3** *S. nux-vomica* seeds - 100 µg/ml

**Figure 39** The 100 images of DNA damaged in human lymphocyte cells by visual scoring under the magnification of 400X (Cont.)



**Figure 40.1** Positive control ( $\text{H}_2\text{O}_2$ ) - 25  $\mu\text{g}/\text{ml}$



**Figure 40.2** Negative control (PBS)

**Figure 40** The 100 images of DNA damaged in human lymphocyte cells by visual scoring under the magnification of 400X (Cont.)

## VITA

Miss Yada Hiruntad was born on November 21, 1989 in Nakhon Ratchasima, Thailand. She got a Bachelor's degree of Applied Thai Traditional medicine from School of Health Sciences, Mae Fah Luang University, Thailand in 2012.

### Poster presentation

1. Hiruntad, Y., Palanuvej, C. and Ruangrunsi, N. Pharmacognostic specification and quantitative analysis of strychnine and brucine in *Strychnos nux-vomica* L. seeds. Poster presentation in The 3rd International Conference on Advanced Pharmaceutical Research (ICAPH), March 12, 2016, Rangsit University, Pathumthani, Thailand

### Publication

2. Hiruntad, Y., Palanuvej, C. and Ruangrunsi, N. Pharmacognostic specification and quantitative analysis of strychnine and brucine in *Strychnos nux-vomica* seeds. *Bulletin of Health Science and Technology*, 2016. 14(1): (In press)



จุฬาลงกรณ์มหาวิทยาลัย  
CHULALONGKORN UNIVERSITY