

CHAPTER II

THEORY AND LITERATURE REVIEWS

The exhaust gases from motor vehicles contribute to a large extent to air pollution through their content in NO_x and SO_x . Moreover, sulfur is a well-known poison for catalytic converters. This led the governments of numerous countries to adopt new regulations which aim at a drastic reduction of sulfur emissions by imposing a very low concentration of this element in fuels.

2.1 Sulfur compounds in crude oil

The chemical compositions of crude oil are uniform even though their physical characteristics vary widely. The elementary composition of crude oil usually falls within the following ranges in Table 2.1.

Table 2.1 Elementary composition of crude oil

Element	%wt.
Carbon	84 - 87
Hydrogen	11 - 14
Sulfur	0 - 3
Nitrogen	0 - 0.6

Sulfur content and API gravity are two properties, which have had the greatest influence on the value of crude oil, although nitrogen and metal contents are increasing in importance. The sulfur content is expressed as percent sulfur by weight and varies from less than 0.1% to greater than 5%. Sulfur is the heteroatom most frequently found in crude oil. Sulfur concentration can range from 0.1% to greater than 8% by weight; moreover, this content is correlated with the gravity of the crude oil and, therefore, its quality (light or heavy oil).

hydrocarbon groups, the compound is called a sulfide or thioether. The disulfides are formed either from mercaptans by oxidation or from sulfides and sulfur. Thiophenes are sulfur compounds with one to several rings structure and their alkyl or aryl substituents. Examples of sulfur compounds are shown in Table 2.2.

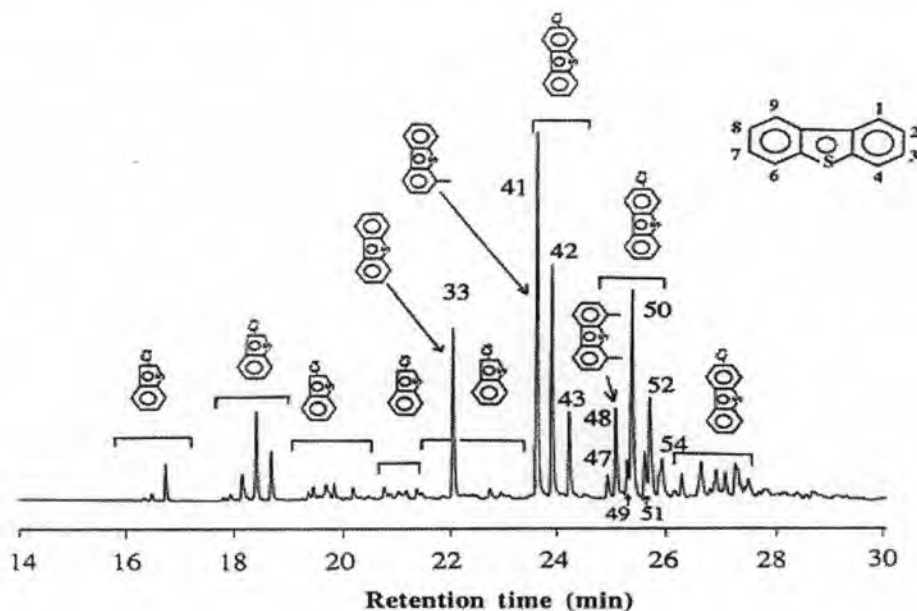

Figure 2.1 GC-AED chromatogram of sulfur compounds in crude oil.

Crude oil is passed through several operations designed to separate it into fractions, to convert the certain fractions from the primary distillation (usually material of high molecular weight) to products of greater market and to purify the products, especially to remove the sulfur compounds. Many of the products made by the process of separation and conversion need further treatment by hydrotreating, before they can be distributed for use. Not only is good technical performance in an appliance needed but color, smell, stability on storage are all important and the removal, or limitation, of constituents harmful in use is also desirable [6].

2.2 Sulfur compounds in transportation fuels

Various refinery streams are used to produce three major types of transportation fuels, gasoline, jet fuels and diesel fuel that differ in composition and properties. The common types of sulfur compounds in liquid fuels are listed in Table 2.3.

Table 2.3 The common types of sulfur compound in transportation fuels

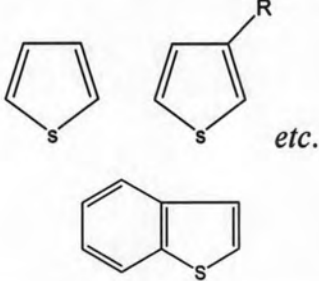
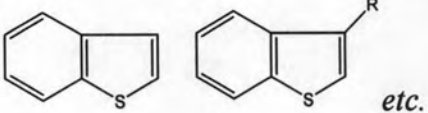
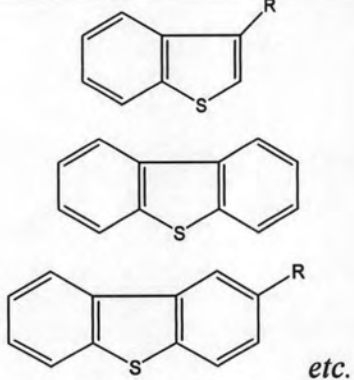
Common types	Compound class	Structure
Gasoline range: Naphtha, Fluid Catalytic Cracking (FCC)	mercaptans	RSH
	sulfides	RSR'
	disulfides	RSSR'
	thiophene (T) and its alkylated derivatives benzothiophene	 <p>The structures show a thiophene ring (a five-membered ring with one sulfur atom) and its alkylated derivative with an 'R' group attached to the ring. Below these is the structure of benzothiophene, which consists of a benzene ring fused to a thiophene ring. The text 'etc.' is placed to the right of the thiophene structures.</p>
Jet fuel range: heavy naphtha, middle distillate	benzothiophene (BT) and its alkylated derivatives	 <p>The structures show benzothiophene (a benzene ring fused to a thiophene ring) and its alkylated derivative with an 'R' group attached to the thiophene ring. The text 'etc.' is placed to the right of the structures.</p>
Diesel fuel range: middle distillate, Light Cycle Oil (LCO)	alkylated benzothiophenes dibenzothiophene (DBT) and its alkylated derivatives	 <p>The structures show an alkylated benzothiophene (benzothiophene with an 'R' group), dibenzothiophene (two benzene rings fused to a central thiophene ring), and an alkylated dibenzothiophene (dibenzothiophene with an 'R' group). The text 'etc.' is placed to the right of the structures.</p>

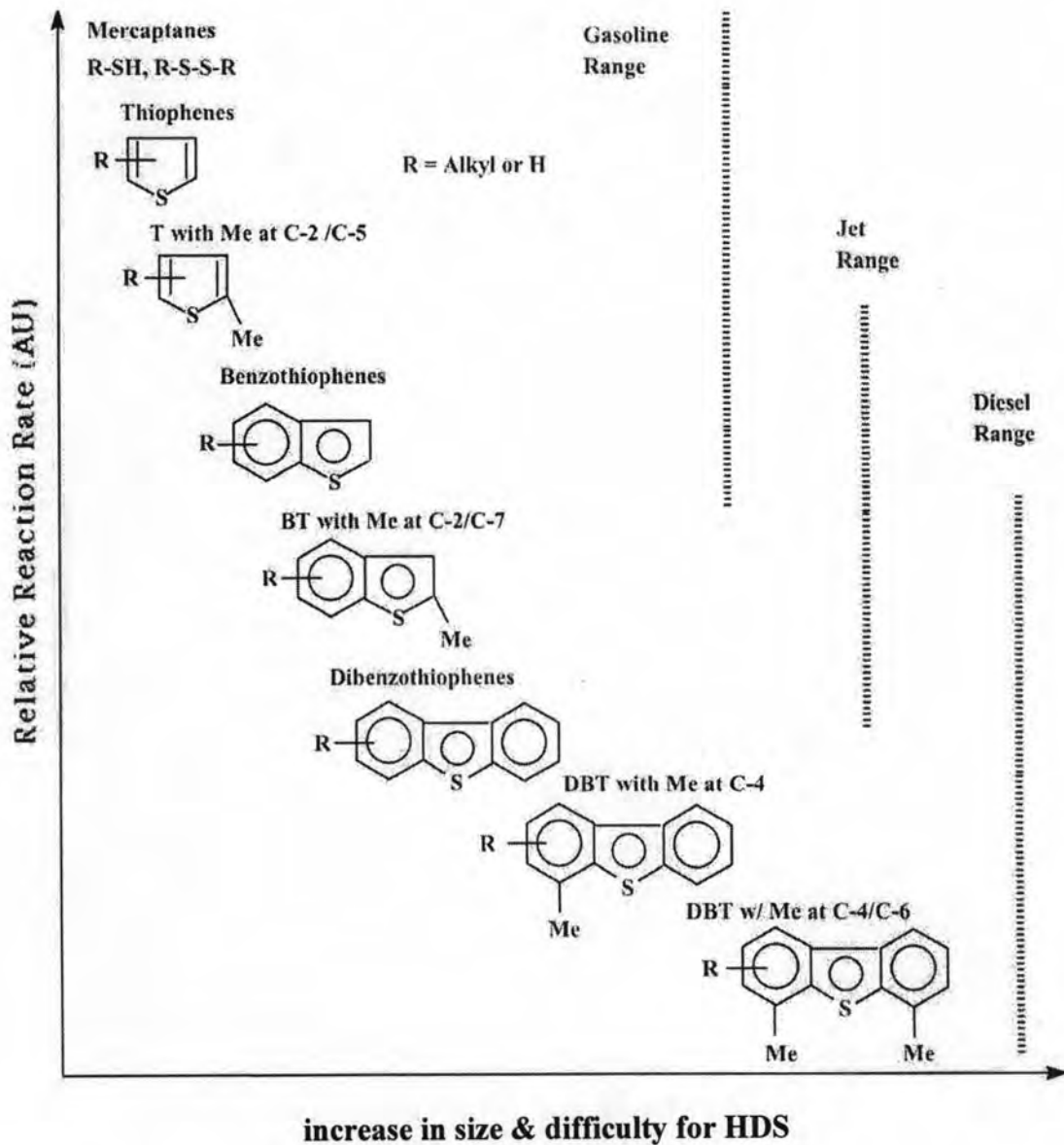

Figure 2.2 Reactivity of various organic sulfur compounds in HDS of transportation fuels.

Figure 2.2 presents a qualitative relationship between the type and size of sulfur molecules [7]. For the sulfur compounds without a conjugation structure between the lone pair on S atom and the π -electrons on aromatic ring, including disulfides, sulfides, thiols, and tetrahydrothiophene, hydrodesulfurization occurs directly through hydrogenolysis pathway. These sulfur compounds exhibit higher HDS reactivity than that of thiophene by an order of magnitude, because they have higher electron density on the S atom and weaker C-S bond. The reactivities of the 1- to 3-ring sulfur compounds decrease in the order thiophenes > benzothiophenes > dibenzothiophenes.

In naphtha, thiophene is so much less reactive than the thiols, sulfides, and disulfides that the latter can be considered to be virtually infinitely reactive in practical high-conversion processes [8]. Similarly, in gas oils, the reactivities of (alkyl-substituted) 4-methyldibenzothiophene(4-MDBT) and 4,6-dimethyldibenzothiophene (4,6-DMDBT) are much lower than those of other sulfur-containing compounds [9, 10]. Consequently, in deep HDS, the conversion of these key substituted dibenzothiophenes largely determines the required conditions. It was pointed out in 1997 that 4-methyldibenzothiophene and 4,6-DMDBT are the most appropriate compounds for investigations of candidate catalysts and reaction mechanisms [10].

Figure 2.3 shows the sulfur compounds in the finished products of gasoline, jet fuel, and diesel fuel that are representative of current commercial transportation fuels in the US [11]. It can be seen that in each of the fuels, what are left as sulfur compounds in the finished products are those that have lower reactivities among all the sulfur compounds.

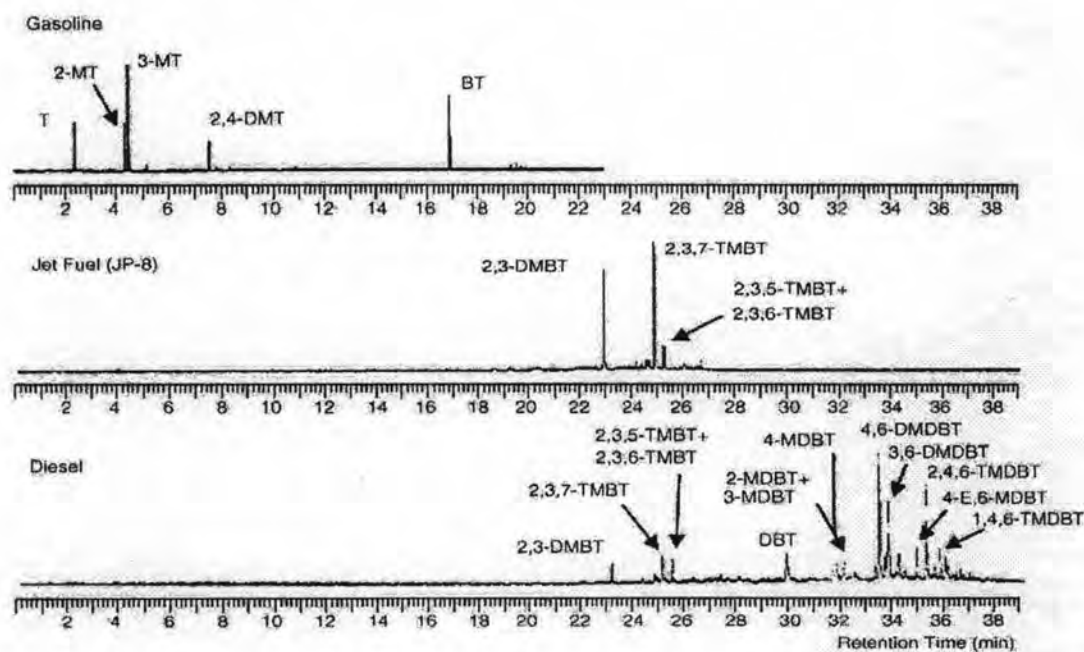

Figure 2.3 Sulfur compounds in commercial gasoline, jet fuel and diesel fuel identified by GC-FPD analysis coupled with GC-MS.

2.3 Hydrotreating

The hydrotreating of petroleum represents one of the largest scale chemical processes carried out by industry in the world today. It included hydrodesulfurization, hydrodenitrogenation, and hydrogenation. In hydrodesulfurization and hydrocracking, cracking and desulfurization operations occur simultaneously and it is relative as to which predominates of feed [12]. All the reactions are exothermic, so the control of temperature in the reactor, especially the catalyst bed, is very important. The methods of treatment range from involving a controlled chemical reaction to an extension of the physical separations already applied.

Thus, hydrotreating is a process to catalytically stabilize petroleum products and/or remove objectionable elements from products of feedstocks by reacting them with hydrogen at high pressure over a hot heterogeneous catalyst [13]. Stabilization usually involves converting unsaturated hydrocarbons such as olefins and gum-forming unstable diolefins to paraffins. Objectionable elements removed by hydrotreating include sulfur, nitrogen, oxygen, halides, and residual metals prior to further processing. These contaminants can affect on the equipment, the catalysts, and the quality of the finished product. Typically, hydrotreating done prior to processes such as catalytic reforming so that the catalyst is not contaminated by feedstock. Hydrotreating is also used prior to catalytic cracking to reduce sulfur and improve product and to upgrade middle-distillate petroleum fractions into finished kerosene and diesel fuel.

A typical hydrotreating unit is shown in Figure 2.4 [14].



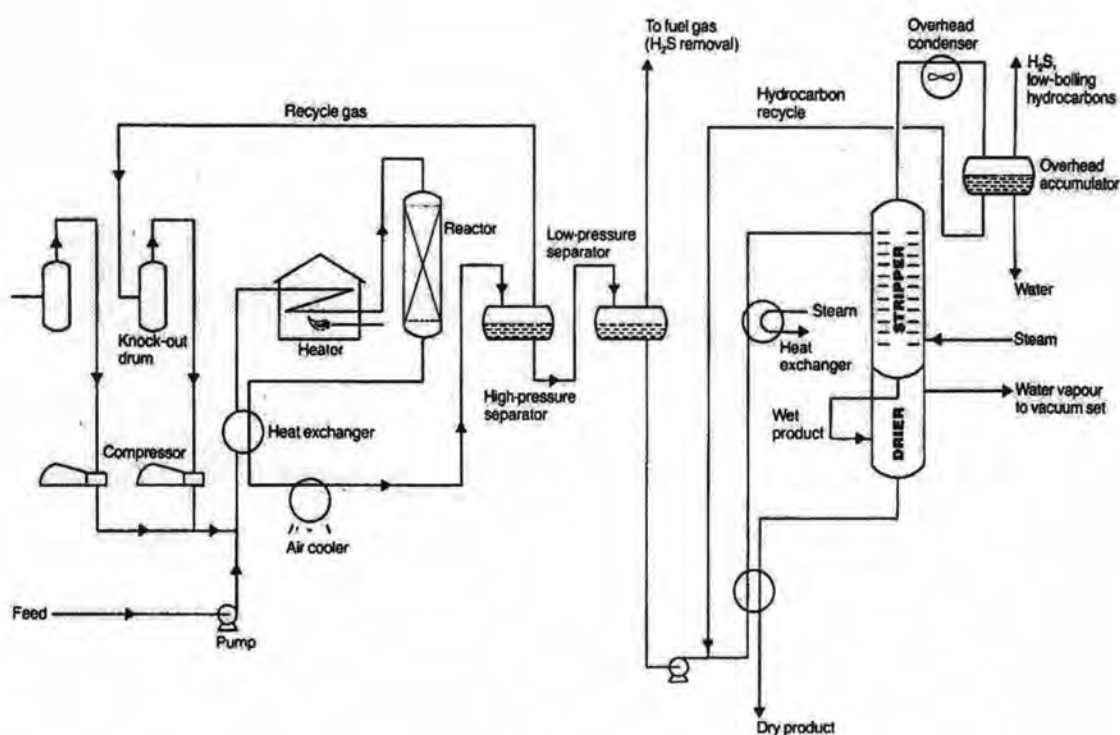

Figure 2.4 Hydrotreating unit.

The oil feed is mixed with hydrogen-rich gas either before or after it is preheated to the proper reactor inlet temperature by heat exchange with reactor effluent and by a furnace. Most hydrotreating reactions are carried out below $427\text{ }^{\circ}\text{C}$ to minimize cracking and the feed is usually heated to between $260 - 427\text{ }^{\circ}\text{C}$. The oil feed combined with the hydrogen-rich gas enters the top of the fixed-bed reactor loaded with catalyst. In the reactor, the sulfur and nitrogen compounds present in oil feed to produce hydrogen sulfide and ammonia, respectively, the olefins present are saturated with hydrogen and the oil feed will be free from metals. The metals remain on the surface of the catalyst and the reaction products leave the reactor with the oil-hydrogen stream. The reactor effluent is cooled, typically $40 - 50\text{ }^{\circ}\text{C}$, before separating the oil from the hydrogen-rich gas. The hydrogen-rich gas from the high-pressure separation is recycled to combine with the feed, and the low-pressure off-gas stream rich in hydrogen sulfide is sent to a gas-treating unit, where hydrogen sulfide is removed. The clean gas is then suitable as fuel for the refiner furnaces. The liquid stream, the product from hydrotreating, is stripped off any remaining hydrogen sulfide and other undesirable components in a stripping column [5, 14].

Feedstocks, either petroleum or coal-derived liquids, usually contain impurities such as nitrogen, sulfur, oxygen, and metal compounds. The sulfur compounds are removed for one of the following reasons:

- (1) To prevent poisoning of sulfur-sensitive metal catalysts used in subsequent reactions and the catalytic converter in an automobile.
- (2) To remove the unpleasant odor.
- (3) To minimize the amounts of sulfur oxides introduced into the atmosphere (contribution to acid rain) by combustion of petroleum-based fuels in catalytic cracking to meet environmental restrictions.
- (4) To reduce the amount of corrosion in the refining process.

There are three major ways of sulfur removal process [15]:

- (1) *Oxidation process.* This process converts mercaptans to the alkyl disulfides, which are much less offensive in smell, by copper chloride and hypochlorite. The copper chloride can be used either as a fixed bed or can be mixed as powder with the oil.
- (2) *Mercaptan dissolving process.* This process involves washing the gasoline with sodium, calcium, or magnesium hydroxides for the removal of low concentrations of hydrogen sulfide and mercaptans but it is not economical when they are present in high concentrations because the alkali solution is usually discarded and replaced when exhausted.
- (3) *Hydrodesulfurization process.* This process removes other sulfur compounds along with mercaptans, hydrogen sulfide, and sulfide. The thiophenes, benzothiophenes, and dibenzothiophenes are the most difficult to remove in those simple ways and have been the focus of most hydrodesulfurization studies.

2.4 Hydrodesulfurization

A general reaction pathway for the HDS of sulfur compound is presented in Eq. 2.1:



The hydrogen sulfide is then removed in the stabilizing tower of the fractional system. The remaining traces are easily removed by washing with aqueous alkali.

Alkyl sulfur compounds react quite easily, but the heterocyclic compounds are more stable. Thiophene and its derivatives are therefore often used as model reactants for HDS since they represent the most difficult compounds in fuel feedstocks to desulfurize. Major source of aromatic sulfur compounds in gasoline are coking and cracking naphthas. In the latter, the content of sulfur may be as high as 1300 ppm with a 2:1 predominance of benzothiophenes over thiophenes.

The hydrodesulfurization reaction generally proceeds through two parallel pathways. The first assumes that hydrogenation of the unsaturated heterocycle to a saturated (or partially saturated) species is followed by hydrogenolysis, while the second postulates that hydrogenolysis occurs first and that the product moieties are hydrogenated in subsequent steps. The principle mechanisms proposed for the hydrodesulfurization of benzothiophene are summerized in Figure 2.5.

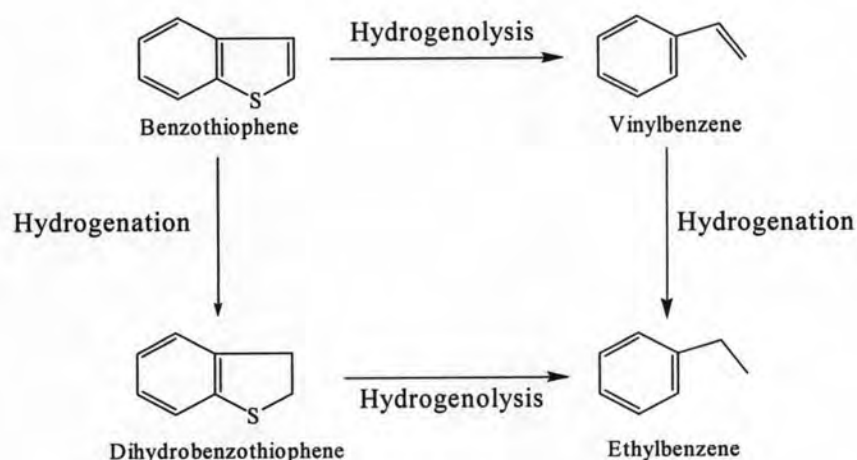

Figure 2.5 Reaction pathways for benzothiophene hydrodesulfurization.

Two major reaction pathways for the hydrodesulfurization of benzothiophene have occurred [16]:

- (1) Benzothiophene is desulfurized prior to partial hydrogenation to dihydrobenzothiophene to give styrene, which is hydrogenated to ethylbenzene.
- (2) Benzothiophene is hydrogenated prior to desulfurization to give dihydrobenzothiophene, which is desulfurized to ethylbenzene.

2.5 Catalyst for hydrodesulfurization

Catalysts developed for hydrodesulfurization are derived from oxides of transition metals supported on different compounds, although the most commonly used is alumina. These catalysts are converted, at least partially, to sulfides during operation. Some commercial catalysts are presulfided, that is, already converted to sulfide form before being used. Sulfiding the catalyst involves both replacement of some oxide anions by sulfide and partial reduction of the metal. The two elements which are constituents of hydrodesulfurization catalysts are molybdenum or tungsten. Combination of either of these elements with cobalt or nickel make especially effective hydrodesulfurization catalysts. The molybdenum oxide supported on alumina and promoted by cobalt is the most general use today because it has proven to be highly selective for sulfur removal, easy to regenerate and resistant to poisons. The ratio of molybdenum to cobalt is always considerably greater than 1. However, neither cobalt nor nickel is, by itself, a good catalyst. Substances which have little or no catalytic activity themselves but which enhance the effectiveness of other catalytically active materials, are called promoters [17, 18].

The conventional CoMo/Al₂O₃ catalyst is prepared by impregnation of γ -Al₂O₃ with an aqueous solution of molybdenum and cobalt salts. This precursor is dried and calcined. Enough molybdenum is used to give about one monolayer on the surface. In acidic solutions, the molybdate is present almost exclusively in the form of heptamers, [Mo₇O₂₄]⁶⁻, and the resulting surface species are believed to be present in islands containing presumably seven Mo ions, with Mo-O-Al bonds. There are also

The cobalt promoter ions are believed to be present at the edges. A surface model of alumina supported Co-Mo binary catalysts is presented in Figure 2.4. Mo is present as microcrystalline MoS_2 and Co as Co_9S_8 , Co^{2+} in the alumina phase and Co species interacting with the MoS_2 phase. The active species are proposed to be a so called CoMoS phase in which atomically dispersed Co sulfides are believed to be anchored on the edge surface of MoS_2 particles [21]. A Co atom is connected to MoS_2 by four sulfur atoms. An additional sulfur atom is attached to a Co atom [22]. The CoMoS structures are shown in Figure 2.7.

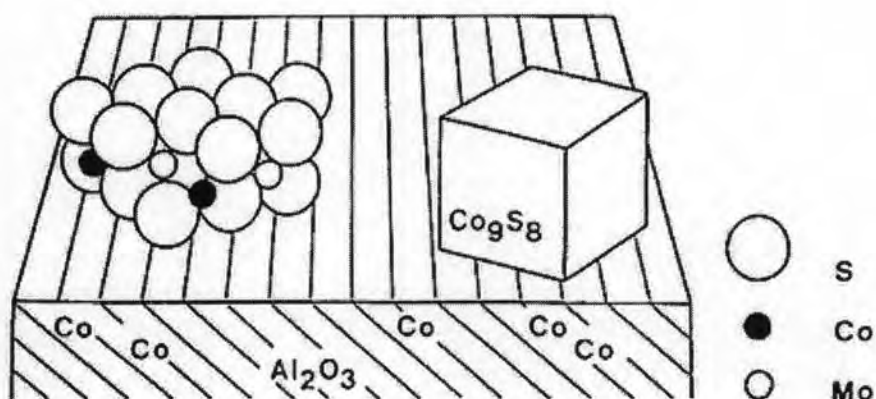

Figure 2.7 Structure model of a sulfided CoMo/ Al_2O_3 catalyst.

The numerous catalysts known today can be classified according to various criteria: structure, composition, area of application, or state of aggregation. The catalysts shall classify according to the state of aggregation in which they act. There are two large groups: heterogeneous catalysts (solid-state catalysts) and homogeneous catalysts.

In industrial use, both types of catalyst are subjected to deactivation as a result of chemical or physical processes. Table 2.4 summarizes the advantages and disadvantages of the two classes of catalyst.

Table 2.4 Comparison of homogeneous and heterogeneous catalysts

	Homogeneous	Heterogeneous
<i>Effectivity</i>		
Active centers	All metal atoms	Only surface atoms
Concentration	Low	High
Selectivity	High	Lower
Diffusion problems	Practically absent	Present (mass-transfer controlled reaction)
Reaction conditions	Mild (50 - 200 °C)	Severe (often >250 °C)
Applicability	Limited	Wide
Activity loss	Irreversible reaction with products (cluster formation); poisoning	Sintering of the metal crystallites; poisoning
<i>Catalyst properties</i>		
Structure/stoichiometry	Defined	Undefined
Modification possibilities	High	Low
Thermal stability	Low	High
<i>Catalyst separation</i>		
	Sometimes laborious(chemical decomposition, distillation, extraction)	Fixed-bed: unnecessary Suspension: filtration
<i>Catalyst recycling</i>		
	Possible	Unnecessary (fixed-bed) or easy (suspension)
<i>Cost of catalyst losses</i>		
	High	Low

2.5.1 Homogeneous catalyst

Catalytic processes that take place in a uniform gas or liquid phase are classified as homogeneous catalysis. Homogeneous catalysts are generally well-defined chemical compounds or coordination complexes, which together with the reactants, are molecularly dispersed in the reaction medium. Due to their high degree of dispersion, homogeneous catalysts exhibit a higher activity per unit mass of metal than heterogeneous catalysts. The high mobility of the molecules in the reaction mixture results in more collisions with substrate molecules. The reactants can approach the catalytically active center from any direction, and a reaction at an active center does not block the neighboring centers. This allows the use of lower catalyst concentrations and milder reaction conditions.

2.5.2 Heterogeneous catalyst

Heterogeneous catalysis takes place between several phases. Generally the catalysts are metals or metal compounds, and the reactants are gases or liquids. The catalyst surface exposed to fluid reactants is responsible for the catalytic effect. It is natural then that the catalyst be made to have a high exposed surface area per unit weight [23].

Alumina-supported CoMo and NiMo, heterogeneous catalyst, have been conventional catalysts of petroleum hydrotreatment for a long time. However, the development of novel catalysts with high catalytic activity is needed in order to achieve clean fuel production.

In 1993, Ishihara, A. *et al.* [24] investigated the catalysts for hydrodesulfurization of dibenzothiophene. They found that the catalysts prepared from silica-alumina supported molybdenum compounds showed higher yields of biphenyl, cyclohexylbenzene and bicyclohexyl than conventional sulfided molybdena-alumina. Specifically, the catalysts derived from silica-alumina supported anionic molybdenum carbonyls gave the highest yields among silica-alumina supported ones.

In 1994, Lee, D. K. *et al.* [25] investigated the effects of transition metal addition to a commercial CoMo/ γ -Al₂O₃ catalyst on the hydrotreatment of atmospheric residual oil. Among the transition metals added to CoMo/ γ -Al₂O₃ catalyst, nickel and tungsten improved the performance of the catalyst, while ruthenium showed no effects. NiCoMo/ γ -Al₂O₃ and WCoMo/ γ -Al₂O₃ showed higher activities and more improved maintenance in all hydrotreating reactions than did a commercial CoMo/ γ -Al₂O₃ catalyst, which was due mainly to the increase in the hydrodesulfurization catalytic activity.

In 1996, Isoda, T. *et al.* [26] examined the catalytic activities of sulfided Ru-CoMo/Al₂O₃ for the desulfurization of 4,6-dimethyldibenzothiophene (4,6-DMDBT) in decane and decane with naphthalene to find selective catalysts which desulfurize 4,6-DMDBT in the presence of naphthalene through preferential hydrogenation of its phenyl ring. Addition of Ru to CoMo catalyst exhibited an excellent activity for hydrodesulfurization of 4,6-DMDBT and suffered less inhibition by coexisting naphthalene, whereas significant retardation was observed over NiMo/Al₂O₃ and Ru-NiMo/Al₂O₃. RuS₂ is suggested as the site for the selective hydrogenation of 4,6-DMDBT, the hydrogenated product of which is transferred immediately to the Co-Mo-S active site to be desulfurized.

In 1996, Isoda, T. *et al.* [27] also studied the hydrodesulfurization of 4,6-DMDBT over a zeolite-Y containing CoMo/Al₂O₃, conventional CoMo/Al₂O₃ and NiMo/Al₂O₃. Isomerization and considerable transalkylation of 4,6-DMDBT into 3,6-DMDBT and into tri- or tetramethyldibenzothiophenes, respectively, were observed over CoMo/Al₂O₃-zeolite catalyst. Migration of methyl groups enhances the hydrodesulfurization reactivity of the sulfur species by diminishing the steric hindrance.

In 1997, Farag, H. *et al.* [28] synthesized several series of Co-Mo-based carbon catalysts using three methods, successive impregnation, successive impregnation with sulfidation in between, and equilibrium adsorption methods. The activities of sulfided catalysts for hydrodesulfurization of dibenzothiophene (DBT) and 4,6-dimethyldibenzothiophene (4,6-DMDBT) as models of sulfur-containing

compounds found in petroleum oil were studied using an autoclave reactor operating at 2.9 MPa hydrogen pressure. The activity results were found to be highly dependent on the method of preparation. Sulfidation of the Mo precursor before cobalt (promoter) addition was found to greatly enhance the activity, which is nearly 2-fold as active as the commercial Co-Mo/Al₂O₃ catalyst. Furthermore, the highest synergetic effect between Co and Mo for hydrodesulfurization activity was observed at a Co/Mo atomic ratio of 0.325.

In 1999, Song *et al.* [29] reported on the catalytic activity of unsupported Mo sulfide catalysts which prepared by a new method comprised of decomposing ammonium tetrathiomolybdate (ATM) in an organic solvent with added water under H₂ pressure. Reactions of 4-(1-naphthylmethyl)biphenyl (NMBB), model compound were carried out at 350 – 425 °C under H₂ pressure in order to examine the activity of the Mo sulfide catalysts for C-C bond cleavage and hydrogenation. Two-step tests revealed that the addition of water is effective for generating highly active Mo sulfide catalyst from ATM, but water itself does not promote catalytic conversion. Removal of water after the decomposition of ATM with added water at 350 – 400 °C under H₂ pressure by hot purging gives highly active Mo sulfide catalyst.

In 2002, Song *et al.* [30] also examined the effect of water addition on C-O bond cleavage and aromatic hydrogenation of dinaphthyl ether (DNE) using MoS₂ catalyst *in situ* generated from ammonium tetrathiomolybdate (ATM) in a microreactor at 350 – 425 °C under H₂ pressure. Addition of water dramatically increased DNE conversion at lower temperature (350 °C) from 46.0 to 83.8 %, the main role of water is to promote the formation of highly active MoS₂ catalyst. BET measurements showed that the MoS₂ generated with added water at 350 °C has much higher surface area, 335 m²/g, and much higher porosity, 0.85 ml/g, than the MoS₂ from ATM alone (54 m²/g, 0.17 ml/g).

In 2004, Alvarez *et al.* [31] compare studied of MoS₂ prepared by *ex situ/in situ* activation of ammonium tetrathiomolybdate (ATM). The *ex situ* activation, the precursor was decomposed under a H₂S/H₂ (15%(v/v H₂S)) flow at 400 °C for 4 h. before run hydrodesulfurization whereas the *in situ* activation,

precursor was decomposed in the reaction media of decalin solvent with H₂ pressure 30 atm, 350 °C for 5 h. during the hydrodesulfurization of dibenzothiophene. MoS₂ catalysts prepared from two mode of activation were evaluated for the HDS of DBT, the *in situ* activation appears much more efficient in achieving HDS active catalyst than the *ex situ* preparation. The *in situ* mode of activation generates high surface area MoS₂-based materials (59.9 m²/g) while only low surface areas were obtained using the *ex situ* preparation (8 m²/g). Indeed, the MoS₂ *in situ* catalysts is 3.5 times (34% DBT conversion) as active as MoS₂ *ex situ* counterpart (10% DBT conversion).