

ผลของสภาพนำไฟฟ้าของตัวอย่างต่อการสกัดโครเมียม(VI) ด้วยอิเล็กโทรเมมเบรน

นางสาวอังคณา อติกานต์สกุล

จุฬาลงกรณ์มหาวิทยาลัย
CHULALONGKORN UNIVERSITY

บทคัดย่อและแฟ้มข้อมูลฉบับเต็มของวิทยานิพนธ์ตั้งแต่ปีการศึกษา 2554 ที่ให้บริการในคลังปัญญาจุฬาฯ (CUIR)
เป็นแฟ้มข้อมูลของนิสิตเจ้าของวิทยานิพนธ์ ที่ส่งผ่านทางบัณฑิตวิทยาลัย

The abstract and full text of theses from the academic year 2011 in Chulalongkorn University Intellectual Repository (CUIR)
are the thesis authors' files submitted through the University Graduate School.

วิทยานิพนธ์นี้เป็นส่วนหนึ่งของการศึกษาตามหลักสูตรปริญญาวิทยาศาสตรมหาบัณฑิต

สาขาวิชาเคมี ภาควิชาเคมี

คณะวิทยาศาสตร์ จุฬาลงกรณ์มหาวิทยาลัย

ปีการศึกษา 2557

ลิขสิทธิ์ของจุฬาลงกรณ์มหาวิทยาลัย

EFFECT OF SAMPLE ELECTRICAL CONDUCTIVITY ON ELECTROMEMBRANE EXTRACTION
OF CHROMIUM(VI)

Miss Ungkhana Atikarnsakul



A Thesis Submitted in Partial Fulfillment of the Requirements
for the Degree of Master of Science Program in Chemistry
Department of Chemistry
Faculty of Science
Chulalongkorn University
Academic Year 2014
Copyright of Chulalongkorn University

Thesis Title	EFFECT OF SAMPLE ELECTRICAL CONDUCTIVITY ON ELECTROMEMBRANE EXTRACTION OF CHROMIUM(VI)
By	Miss Ungkhana Atikarnsakul
Field of Study	Chemistry
Thesis Advisor	Assistant Professor Pakorn Varanusupakul, Ph.D.

Accepted by the Faculty of Science, Chulalongkorn University in Partial
Fulfillment of the Requirements for the Master's Degree

.....Dean of the Faculty of Science
(Professor Supot Hannongbua, Dr.rer.nat.)

THESIS COMMITTEE

.....Chairman
(Associate Professor Vudhichai Parasuk, Ph.D.)

.....Thesis Advisor
(Assistant Professor Pakorn Varanusupakul, Ph.D.)

.....Examiner
(Assistant Professor Fuangfa Unob, Ph.D.)

.....External Examiner
(Assistant Professor Orawan Kritsunankul, Ph.D.)

อังคณา อติกานต์สกุล : ผลของสภาพนำไฟฟ้าของตัวอย่างต่อการสกัดโครเมียม(VI) ด้วยอิเล็กโทรเมมเบรน (EFFECT OF SAMPLE ELECTRICAL CONDUCTIVITY ON ELECTROMEMBRANE EXTRACTION OF CHROMIUM(VI)) อ.ที่ปรึกษาวิทยานิพนธ์หลัก: ผศ. ดร.ปกรณ์ วรานุศุภากุล, 84 หน้า.

ในงานวิจัยนี้ได้ศึกษาอิทธิพลของปริมาณไอออนในสารละลายตัวอย่างต่อประสิทธิภาพการสกัดโครเมียม(VI) ด้วยอิเล็กโทรเมมเบรน โดยใช้สารละลายตัวอย่างที่ประกอบด้วยเกลือความเข้มข้นแตกต่างกันในช่วง 0.0 ถึง 5.0 มิลลิโมลาร์ เป็นตัวแทนของสารละลายที่มีค่าการนำไฟฟ้าแตกต่างกันในช่วง 1.0 ถึง 630.0 ไมโครซีเมนต์ต่อเซนติเมตร ผลการศึกษาเบื้องต้นพบว่า 2-ไนโตรฟีนอลออกทิลอีเทอร์ เป็นตัวทำละลายอินทรีย์ที่พ่วงด้วยเมมเบรนที่ให้ประสิทธิภาพดีในการสกัดโครเมียม(VI) ในตัวอย่างที่มีค่าการนำไฟฟ้าแตกต่างกัน โดยสามารถควบคุมการเกิดฟองอากาศ (ที่เกิดจากปฏิกิริยาอิเล็กโทรไลซิสของน้ำ) ได้ทั้งในภาวะความต่างศักย์ไฟฟ้าสูงและเวลาสกัดที่นานด้วยคุณสมบัติความหนืดและค่าคงที่ไดอิเล็กทริก ต่อมา ได้ทำการศึกษาภาวะที่เหมาะสมของเทคนิคการสกัดด้วยอิเล็กโทรเมมเบรนในการสกัดโครเมียม(VI) โดยใช้สารละลายเกลือโซเดียมคลอไรด์ความเข้มข้น 5.0 มิลลิโมลาร์ เป็นสารละลายตัวอย่าง ภาวะที่เหมาะสมคือ ใช้ 2-ไนโตรฟีนอลออกทิลอีเทอร์ เป็นตัวทำละลายอินทรีย์ที่พ่วงด้วยเมมเบรน ปรับสารละลายตัวให้ให้เป็นกรดที่พีเอช 4 ด้วยสารละลายอะซิเตตบัฟเฟอร์ ความเข้มข้น 0.1 โมลาร์ ใช้สารละลายตัวรับเป็นกรดอะซิติก ความเข้มข้น 0.5 โมลาร์ ให้ความต่างศักย์ไฟฟ้า 100 โวลต์ และสกัดเป็นเวลา 15 นาที ในการตรวจสอบความถูกต้องของวิธีพบว่า ช่วงความเข้มข้น 10.0 ถึง 80.0 ไมโครกรัมต่อลิตร มีความเป็นเส้นตรงที่ดี มีความสามารถในการเพิ่มความเข้มข้นประมาณ 80 ความแม่นยำและความเที่ยงของวิธีการสกัดเป็นที่ยอมรับ โดยพิจารณาจากเปอร์เซ็นต์การกลับคืนอยู่ในช่วง 98 ถึง 108 เปอร์เซ็นต์ และเปอร์เซ็นต์การเบี่ยงเบนมาตรฐานสัมพัทธ์อยู่ในช่วง 1.0 ถึง 2.3 เปอร์เซ็นต์ ค่าขีดจำกัดต่ำสุดของวิธีการวิเคราะห์ และขีดจำกัดต่ำสุดในการวิเคราะห์เชิงปริมาณคือ 2.1 และ 7.2 ไมโครกรัมต่อลิตร ตามลำดับ เมื่อนำวิธีการสกัดนี้ไปใช้กับน้ำตัวอย่างจริงที่มีปริมาณไอออนแตกต่างกัน เช่น น้ำดื่ม น้ำแร่ น้ำประปา และน้ำจากแหล่งน้ำธรรมชาติ จะพบว่าเมทริกซ์ของตัวอย่างมีผลต่อการวิเคราะห์น้ำตัวอย่าง ดังนั้น การหาช่วงความเป็นเส้นตรงและเปอร์เซ็นต์กลับคืนในน้ำตัวอย่างจริง จึงใช้วิธีการสร้างกราฟมาตรฐานแบบเมทริกซ์แมทซ์ โดยพบว่าช่วงการใช้งานการตรวจวัดโครเมียม(VI) คือ 10.0 ถึง 80.0 ไมโครกรัมต่อลิตร เปอร์เซ็นต์กลับคืนของโครเมียม(VI) อยู่ในช่วง 93 ถึง 140 เปอร์เซ็นต์ และเปอร์เซ็นต์การเบี่ยงเบนมาตรฐานสัมพัทธ์อยู่ในช่วง 1.1 ถึง 11.9 เปอร์เซ็นต์ ค่าขีดจำกัดต่ำสุดของวิธีการวิเคราะห์ และขีดจำกัดต่ำสุดในการวิเคราะห์เชิงปริมาณอยู่ในช่วง 3.4 ถึง 9.0 ไมโครกรัมต่อลิตร และ 12.0 ถึง 24.8 ไมโครกรัมต่อลิตรตามลำดับ ดังนั้นวิธีการนี้จึงเป็นวิธีการสกัดที่มีประสิทธิภาพในการเพิ่มความเข้มข้นของสารในน้ำตัวอย่างหลากหลายชนิด

ภาควิชา เคมี

ลายมือชื่อนิสิต

สาขาวิชา เคมี

ลายมือชื่อ อ.ที่ปรึกษาหลัก

ปีการศึกษา 2557

5672144523 : MAJOR CHEMISTRY

KEYWORDS: ELECTROMEMBRANE EXTRACTION (EME) / SUPPORTED LIQUID MEMBRANE (SLM) / ELECTRICAL CONDUCTIVITY / CHROMIUM(VI)

UNGKHANA ATIKARNSAKUL: EFFECT OF SAMPLE ELECTRICAL CONDUCTIVITY ON ELECTROMEMBRANE EXTRACTION OF CHROMIUM(VI). ADVISOR: ASST. PROF. PAKORN VARANUSUPAKUL, Ph.D., 84 pp.

Electromembrane extraction (EME) of chromium(VI) ion in aqueous samples was studied for the influences of ionic contents in the samples on the extraction efficiency. Samples containing various salt concentrations (0.0-5.0 mM) represented by their electrical conductivities ($1.0\text{-}630.0\ \mu\text{S}\cdot\text{cm}^{-1}$) were used. Preliminarily, 2-nitrophenyl octyl ether (NPOE) provided good extraction efficiency (enrichment factor) and tolerated bubble formation at high voltages and long extraction times for samples with wide range of conductivity levels owing to its viscosity and dielectric properties. The EME conditions were optimized for effective extraction of Cr(VI) using samples with high level of conductivity (5.0 mM NaCl, $630\ \mu\text{S}\cdot\text{cm}^{-1}$). Mixtures of NPOE with other organic solvents and ionic carriers, sample pH, types of acceptors, applied voltages and extraction times were investigated. The optimized EME conditions were that SLM was NPOE; donor was adjusted to pH 4 with 0.1 M acetate buffer; acceptor was 0.5 M acetic acid; applied voltage was 100 V; and extraction time was 15 min. The method was evaluated under the optimum conditions. The linear range of the method was $10.0\text{-}80.0\ \mu\text{g}\cdot\text{L}^{-1}$. The enrichment factors were approximately 80. The recoveries of 98-108% with %R.S.D. of 1.0-2.3% were obtained. The limit of detection (LOD) and limit of quantitation (LOQ) were 2.1 and $7.2\ \mu\text{g}\cdot\text{L}^{-1}$, respectively. The method was applied to real water samples with variety of ionic contents, for example, drinking water, mineral water, tap water, and surface water. The matrix effect was observed. Therefore, the linearity and recovery in the real samples were evaluated using matrix-match standard method. The working ranges were about $10.0\text{-}80.0\ \mu\text{g}\cdot\text{L}^{-1}$. The recoveries of spiked Cr(VI) in real water samples were 93-140% with %RSD between 1.1-11.9%. The LOD and LOQ were in the range of $3.4\text{-}9.0\ \mu\text{g}\cdot\text{L}^{-1}$ and $12.0\text{-}24.8\ \mu\text{g}\cdot\text{L}^{-1}$, respectively. The method provided good extraction and preconcentration performance in variety of samples.

Department: Chemistry

Student's Signature

Field of Study: Chemistry

Advisor's Signature

Academic Year: 2014

ACKNOWLEDGEMENTS

The research was performed at Department of Chemistry, Faculty of Science, Chulalongkorn University, Bangkok, Thailand.

First of all, I would like to express my deepest gratitude to my thesis advisor, Assistant Professor Pakorn Varanusupakul, for his professionalism, generosity, plentiful guidance, continuous assistance, sincere encouragements, kind patience for my mistake, and critical proofreading throughout this research. I would like to extend my appreciation to all thesis committees for their insightful comments and suggestions.

The Scholarship from the Graduate School, Chulalongkorn University to commemorate the 72nd anniversary of his Majesty King Bhumibala Aduladeja is gratefully acknowledged. This research was financially supported by the 90th Anniversary of Chulalongkorn University Fund and Ratchadapisek Sompoch Endowment Fund, Chulalongkorn University (Sci-Super 2014-004).

In addition, warm thanks to all members of the Chromatography and Separation Research Unit (ChSRU) for their helpfulness and suggestions. I would like to thank my friends at Chulalongkorn University for valuable time and supports. Particularly, many thanks go to all members in PV lab for their cheerful perspectives, helpfulness and friendship.

Finally, I must thank my beloved parents, my two brothers for their unlimited support, love and understanding throughout my study.

CONTENTS

	Page
THAI ABSTRACT	iv
ENGLISH ABSTRACT	v
ACKNOWLEDGEMENTS	vi
CONTENTS	vii
LIST OF TABLES	xii
LIST OF FIGURES.....	xiii
LIST OF ABBREVIATIONS	xvii
CHAPTER I INTRODUCTION.....	1
1.1 Problem definition.....	1
1.2 Literature review	3
1.2.1 Literature reviews for EME of organic compounds.....	4
1.2.2 Literature reviews for different concepts and setups of EME.....	7
1.2.3 Literature reviews for EME of metal ions	10
1.3 Aim and scope of this research	12
CHAPTER II THEORY	13
2.1 Liquid-phase microextraction (LPME)	14
2.1.1 Single drop microextraction (SDME)	15
2.1.2 Hollow fiber-liquid phase microextraction (HF-LPME).....	16
2.1.2.1 Two-phase system of HF-LPME.....	18
2.1.2.2 Three-phase system of HF-LPME.....	19
2.1.2.3 Carrier-mediated HF-LPME	21
2.1.3 Electromembrane extraction (EME).....	22

	Page
2.1.3.1 Parameters affecting EME approach.....	23
2.1.3.1.1 Supported liquid membrane (SLM)	23
2.1.3.1.2 Electrical potential difference.....	25
2.1.3.1.3 Sample solution.....	28
2.1.3.1.4 Acceptor solution	29
2.1.3.1.5 Extraction time	29
2.2 Electrical conductivity.....	30
2.2.1 Principle of electrolyte electrical conductivity	30
2.2.2 Measurement of electrical conductivity.....	32
2.2.3 Relationship between electrical conductivity and ionic strength	33
2.3 Chromium.....	33
2.3.1 Properties and health effects	34
2.3.2 Colorimetric method for determination of Hexavalent chromium	36
CHAPTER III EXPERIMENTAL.....	38
3.1 Instruments and materials	38
3.2 Chemicals and reagents	39
3.3 Preparation of chemical solutions	40
3.3.1 Stock potassium dichromate solution	40
3.3.2 Sodium chloride solution (NaCl); 1 M and 0.5 M.....	40
3.3.3 Sample solutions.....	40
3.3.4 1,5-diphenylcarbazide (DPC) solution; 6 mM.....	41
3.3.5 Sulfuric acid (H ₂ SO ₄) solution; 100.0 mM.....	41
3.3.6 Acetic acid solution (HOAc); 1 M and 0.5 M	41

	Page
3.3.7 Acetate buffer solution; 1 M.....	41
3.4 Experimental.....	42
3.4.1 Electromembrane extraction procedure.....	42
3.4.2 Detection of chromium(VI) by colorimetric method.....	43
3.4.3 Effect of ionic contents in samples (sample electrical conductivities) on electromembrane extraction efficiency of Cr(VI).....	43
3.4.3.1 Type of SLM.....	43
3.4.3.2 Preliminary study of acceptors for chosen SLMs.....	43
3.4.3.3 Effect of sample conductivities on electromembrane extraction profiles of Cr(VI).....	44
3.4.4 Optimization of electromembrane extraction of Cr(VI) from samples with high conductivity.....	44
3.4.4.1 Type of organic solvent.....	45
3.4.4.2 Sample pH.....	45
3.4.4.3 Acceptor type.....	45
3.4.4.4 Applied voltage.....	45
3.4.4.5 Extraction time.....	46
3.4.5 Method evaluation.....	46
3.4.5.1 Calibration curve and linearity.....	46
3.4.5.2 Limit of detection (LOD) and limit of quantification (LOQ).....	46
3.4.5.3 Enrichment factor.....	47
3.4.5.4 Accuracy.....	47
3.4.5.5 Precision.....	48
3.4.5.6 Matrix effect.....	48

	Page
3.4.6 Application of the optimized EME method to real water samples.....	48
CHAPTER IV RESULTS AND DISCUSSION	50
4.1 Preliminary study of acceptors for chosen SLMs.....	50
4.2 Effect of ionic contents in the samples or sample conductivities on electromembrane extraction of Cr(VI).....	51
4.3 Optimization of electromembrane extraction of Cr(VI) from samples with high conductivity.....	56
4.3.1 Type of SLM.....	56
4.3.2 Sample pH.....	57
4.3.3 Type of acceptor.....	60
4.3.4 Applied voltage.....	62
4.3.5 Extraction time.....	63
4.4 Method evaluation.....	65
4.4.1 Calibration curve and linearity.....	65
4.4.2 Limit of detection (LOD) and limit of quantification (LOQ)	66
4.4.3 Enrichment factor.....	66
4.4.4 Accuracy	67
4.4.5 Precision	67
4.4.6 Matrix effect.....	68
4.5 Application of EME method for determination of Cr(VI) from real water samples.....	69
CHAPTER V CONCLUSION.....	71
5.1 Conclusion.....	71
5.2 Suggestion for future study.....	72

	Page
REFERENCES	73
APPENDIX.....	81
VITA.....	84



LIST OF TABLES

Tables	Page
2.1 Conductivity factors of some common ions at 298 K.....	31
2.2 General conductivity of waters at 298 K.....	32
4.1 Properties of organic solvents employed for SLM.....	53
4.2 Conditions of EME for determination of Cr(VI) in ionic samples	65
4.3 Analytical merits of EME of Cr(VI) in high electrical conductivity sample (5.0 mM NaCl)	68
4.4 Analytical performance of EME of Cr(VI) in real water samples.....	70

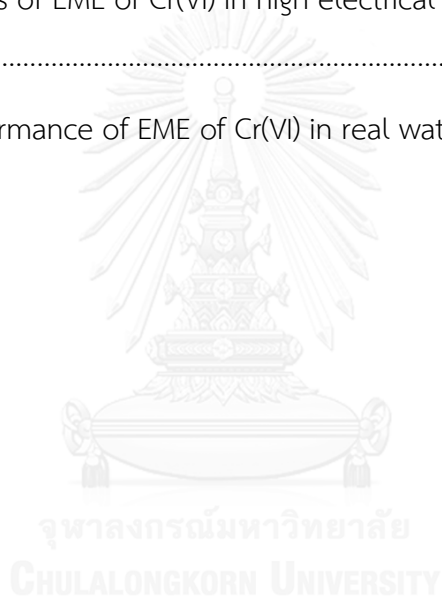

LIST OF FIGURES

Figures	Page
1.1 Schematic diagram of electromembrane isolation (EMI).....	4
1.2 Structure of di-(2-ethylhexyl) phosphate (DEHP)	6
1.3 Structure of 2-nitrophenyl octyl ether (NPOE)	6
1.4 Schematic illustration of PEME setup a) at the beginning of pulse duration, b) at the end of pulse duration, and c) at the end of outage period.....	7
1.5 Schematic illustration of two-way PEME setup	8
1.6 Experiment setup for simultaneous extraction of ATE and BET using two cathodes	9
1.7 Experiment setup for simultaneous extraction of acidic and basic drugs using two hollow fibers with different SLM for anode and cathode.....	9
1.8 Schematic illustration of EME setup using three pieces of hollow fibers.....	10
1.9 Schematic illustration of EME setup using flat sheet membrane.....	10
1.10 Schematic illustration of speciation of chromium by dual EME method].....	11
2.1 Conventional steps in sample preparation process	13
2.2 Setups of single drop microextraction (SDME); a) (DI)-SDME mode; and b) (HS)-SDME mode	16
2.3 Porous hollow fiber membrane.....	17
2.4 Illustration of liquid phase microextraction (LPME).....	17
2.5 Diagrams of HF-LPME systems a) two-phase system and b) three-phase system.....	18
2.6 Three-phase extraction mechanism of HF-LPME for basic analytes	20
2.7 Principle of carrier-mediated HF-LPME.....	21

Figures	Page
2.8 Some ionic carriers used in carrier-mediated HF-LPME	22
2.9 Scheme of basic EME equipment.....	23
2.10 Simulated electronic circuit scheme of SLM in EME system.....	24
2.11 Condenser effect and electric current observed in EME technique after application of voltage	27
2.12 The distribution of voltage in donor, acceptor solutions and SLM, and the electric current on voltage gradient in an EME system	28
2.13 General principle of conductivity measurement.....	32
2.14 Chemical structures of chromium(VI): a) chromate ion (CrO_4^{2-}), b) dichromate ion ($\text{Cr}_2\text{O}_7^{2-}$), and c) hydro chromate ion (HCrO_4^-).....	35
2.15 Speciation diagram of chromium(VI) at distinct pH	35
2.16 Hexavalent chromium calorimetric method	37
3.1 Schematic set-up of electromembrane extraction system.....	42
4.1 Extraction performance of Cr(VI) from MilliQ water using acceptors with different types of SLM; Cr(VI) $50 \mu\text{g}\cdot\text{L}^{-1}$; extraction time: 5 min; applied potential: 50 V; stirring speed: 500 rpm; $n = 3$	50
4.2 Extraction profiles of Cr(VI) from samples with various levels of ionic contents shown as conductivities: a) milliQ water ($1 \mu\text{S}\cdot\text{cm}^{-1}$); b) 1.0 mM NaCl (low level, $120 \mu\text{S}\cdot\text{cm}^{-1}$); c) 2.5 mM NaCl (moderate level, $310 \mu\text{S}\cdot\text{cm}^{-1}$); and d) 5.0 mM NaCl (high level, $630 \mu\text{S}\cdot\text{cm}^{-1}$); acceptor solution: 0.5 M NaCl; $n = 3$	51
4.3 Extraction profile of Cr(VI) from samples with various conductivities using NPOE as the SLM; Cr(VI) $20 \mu\text{g}\cdot\text{L}^{-1}$; SLM: NPOE; acceptor solution: 0.5 M NaCl; applied voltage: 50 V; stirring speed: 500 rpm; $n = 3$	55

Figures	Page
4.4 Current profile in EME system for extraction of Cr(VI) from ionic samples using NPOE as the SLM; Cr(VI) $20 \mu\text{g}\cdot\text{L}^{-1}$ in 5.0 mM NaCl; SLM: NPOE; acceptor solution: 0.5 M NaCl; applied voltage: 50 V; stirring speed: 500 rpm; n = 3.....	55
4.5 Type of SLM on EME efficiency of Cr(VI) from ionic samples; Cr(VI) $20 \mu\text{g}\cdot\text{L}^{-1}$ in 5.0 mM NaCl; acceptor solution: 0.5 M NaCl; extraction time: 15 min; applied voltage: 50 V; stirring speed: 500 rpm; n = 3	57
4.6 Effect of sample pH on extraction of Cr(VI) from ionic samples; Cr(VI) $20 \mu\text{g}\cdot\text{L}^{-1}$ in 5.0 mM NaCl; SLM: NPOE; acceptor solution: 0.5 M NaCl; extraction time: 15 min; applied voltage: 50 V; stirring speed: 500 rpm; n = 3.....	59
4.7 Extraction of Cr(VI) from ionic samples at various acetate buffer concentration; Cr(VI) $20 \mu\text{g}\cdot\text{L}^{-1}$ in 5.0 mM NaCl; SLM: NPOE; acceptor solution: 0.5 M NaCl; extraction time: 15 min; applied voltage: 50 V; stirring speed: 500 rpm; n = 3	60
4.8 Extraction of Cr(VI) from ionic samples at various acceptors; Cr(VI) $20 \mu\text{g}\cdot\text{L}^{-1}$ in 5.0 mM NaCl, 0.1 M acetate buffer; SLM: NPOE; extraction time: 15 min; applied voltage: 50 V; stirring speed: 500 rpm; n = 3	61
4.9 Extraction of Cr(VI) from ionic samples at various concentrations of HOAc; Cr(VI) $20 \mu\text{g}\cdot\text{L}^{-1}$ in 5.0 mM NaCl, 0.1 M acetate buffer; SLM: NPOE; extraction time: 15 min; applied voltage: 50 V; stirring speed: 500 rpm; n = 3.....	62
4.10 Extraction of Cr(VI) from ionic samples at various applied voltages; Cr(VI) $20 \mu\text{g}\cdot\text{L}^{-1}$ in 5.0 mM NaCl, 0.1 M acetate buffer; SLM: NPOE; acceptor solution: 0.5 M HOAc; extraction time: 15 min; stirring speed: 500 rpm; n = 3.....	63
4.11 Extraction time profile of Cr(VI) from ionic samples; Cr(VI) $20 \mu\text{g}\cdot\text{L}^{-1}$ in 5.0 mM NaCl, 0.1 M acetate buffer; SLM: NPOE; acceptor solution: 0.5 M HOAc; applied voltage: 100 V; stirring speed: 500 rpm; n = 3.....	64

Figures	Page
4.12 Calibration curve of EME method for determination of Cr(VI) from ionic water samples (0.5 M NaCl in MilliQ water)	66
4.13 Extraction performance of spiked Cr(VI) from various kinds of real water samples; Cr(VI) 20 $\mu\text{g}\cdot\text{L}^{-1}$ in samples, 0.1 M acetate buffer; SLM: NPOE; acceptor solution: 0.5 M HOAc; applied voltage: 100 V; extraction time: 15 min; stirring speed: 500 rpm; n = 2	69
A.1 Matrix-match standard calibration curve of Cr(VI) in EME analysis of drinking water	74
A.2 Matrix-match standard calibration curve of Cr(VI) in EME analysis of mineral water.....	74
A.3 Matrix-match standard calibration curve of Cr(VI) in EME analysis of CU pond.....	75
A.4 Matrix-match standard calibration curve of Cr(VI) in EME analysis of tap water	75
A.5 Matrix-match standard calibration curve of Cr(VI) in EME analysis of dam water	76

LIST OF ABBREVIATIONS

%	percentage
°C	degree Celsius
Aliquat 336	methyltrioctylammonium chloride
CE	capillary electrophoresis
cm	centimeter
DC	direct current
DEHP	bis (2-ethylhexyl) phosphate
D ₂ EHPA	di(2-ethylhexyl)phosphoric acid
DI-SDME	direct immersion single-drop microextraction
DPC	1,5-diphenylcarbazide
EC	electrical conductivity
EE	extraction efficiency
EF	enrichment factor
EME	electromembrane extraction
ENB	1-ethyl-4-nitrobenzene
g	gram
GC	gas chromatography
HF-LPME	hollow-fiber liquid-phase microextraction
HPLC	high performance liquid chromatography
HS-SDME	headspace single-drop microextraction
I.D.	internal diameter
IPNB	1-isopropyl-4-nitrobenzene
K	kelvin
LLE	liquid-liquid extraction
LODs	limit of detections
LOQs	limit of quantifications
LPME	liquid-phase microextraction
M	molar

mg·L ⁻¹	milligram per liter
min	minute
mL	milliliter
mM	millimolar
mm	millimeter
ng·mL ⁻¹	nanogram per milliliter
NPOE	2-nitrophenyloctyl ether
PEME	pulsed electromembrane extraction
PP	polypropylene
R	recovery
R ²	correlation coefficient
rpm	revolutions per minute
R.S.D.	relative standard deviation
SD	standard deviation
S/N	signal to noise ratio
SDME	single-drop microextraction
SLM	supported liquid membrane
SPE	solid-phase extraction
SPME	solid-phase microextraction
T.D.S.	total dissolved solid
USEPA	The United States Environmental Protection Agency
UV-Vis	ultraviolet-visible
VS-PEME	voltage-step pulsed electromembrane extraction
WHO	World Health Organization
μA	microampere
μg·L ⁻¹	microgram per liter
μL	microliter
μm	micrometer
μS·cm ⁻¹	microsiemens per centimeter

CHAPTER I

INTRODUCTION

1.1 Problem definition

Development of faster, simpler, inexpensive and more environmental friendly sample preparation techniques is an essential issue in analytical chemistry. This process plays important roles in preconcentration and isolation of trace analytes from complicated sample matrices prior to analysis by analytical instruments; for example, gas chromatography (GC), high performance liquid chromatography (HPLC), capillary electrophoresis (CE) and UV-Vis spectrophotometer. Moreover, sample preparation has a direct impact on accuracy, precision and analytical performance. A versatile classical sample pre-treatment technique is liquid-liquid extraction (LLE), which has been generally employed in many standard analytical methods, however; large quantities of toxic organic solvent are typically required, which are expensive and hazardous for environment. Furthermore, the conventional LLE is time consuming and tedious method [1]. Therefore, several sample preparation methods have been developed to overcome those problems such as solid phase extraction (SPE), solid-phase microextraction (SPME) and liquid-phase microextraction (LPME). These techniques use much less amounts of organic solvent and provide higher enrichment factor than LLE. Recently, miniaturization of LLE or LPME has become a trend in sample preparation for extraction and preconcentration of trace analytes in complex samples [2, 3].

In 1996, LPME was first introduced as a solvent microextraction that offered fast, effective and low cost extraction method with less toxic solvent consumption [4]. There are several LPME techniques have been developed. Single drop microextraction (SDME) is a solvent extraction in a microdrop, where target analytes were isolated from an aqueous sample into a small water-immiscible drop of an organic solvent suspending at the tip of a microsyringe needle [4]. SDME has been employed in several different modes; for example, direct immersion (DI)-SDME, headspace (HS)-SDME, three-phase SDME, and continuous flow microextraction for

various analytical applications [2]. Nevertheless, the solvent droplet is difficult to handle. It is difficult to control the droplet size and to collect the droplet back into the microsyringe. Moreover, losing the droplet from the needle tip under high-speed convection is likely. In order to improve the stability and reliability of LPME, in 1999, Pedersen-Bjergaard and Rasmussen [5] introduced a new LPME method, called hollow fiber liquid phase microextraction (HF-LPME).

In HF-LPME technique, the target analytes are extracted from an aqueous sample across a supported liquid membrane (SLM) in the pores of hollow fiber membrane into a small amount (a few microliters) of extracting solvent trapped inside the lumen of the membrane. The HF-LPME technique can be operated in two systems. Firstly, both pores and HF lumen are filled with an organic solvent, so called two-phase system, which is suitable for extraction of hydrophobic compounds. Secondly, the pores are impregnated with an organic solvent, whereas the HF lumen is filled with an aqueous acceptor solution, so called three-phase system, which is appropriate for extraction of hydrophilic compounds. Because the extraction mechanism of HF-LPME is mainly based on passive diffusion, long extraction time (>45 min) is required for good extraction efficiency or high extraction recovery. To overcome these drawbacks, in 2006, Pedersen-Bjergaard and Rasmussen [6] applied an electric field to the HF-LPME technique via two platinum electrodes inside the donor and acceptor solution. The aim of this technique is to enhance the transportation of charged analyte species across the SLM. This technique is called electromembrane extraction (EME) and the type of transportation is called electrokinetic migration.

The EME technique provides rapid, selective, and effective method for determination of target analytes in charged forms. This technique has been also widely used for separation purposes in both purification and sample preparation processes. Generally, EME is performed in three-phase system. If analytes are cationic species, the negative electrode is inserted in the aqueous acceptor solution inside the HF lumen and the positive electrode is placed in the sample solution and vice versa for anionic species.

Over the past few years, several works of EME have been developed for extraction of organic compounds; for example, acidic drugs, hydrophobic and hydrophilic basic drugs [6-22], and peptides [23-25] from biological samples. Besides, some applications of EME have been used for heavy metal cations (Pb^{2+} , U^{6+} , Mn^{2+} , Cd^{2+} , Zn^{2+} , Co^{2+} , Cu^{2+} and Ni^{2+}) in milk, blood, urine, and water samples [26-28]. However, a few work of EME has been applied for metals in anionic form (metal oxyanions) [29]; therefore, development of EME for metal oxyanions such as chromium(VI) ion is interesting.

In this work, Cr(VI) ion, which typically exists in anionic form of chromate ion or dichromate ion, was chosen as a model analyte because it is relatively toxic in the environment. In addition, Cr(VI) ion can be easily and selectively detected by a colorimetric method with 1,5-diphenylcarbazide (DPC) using UV-Vis spectrophotometer at the wavelength of 544 nm.

According to the previous research [30], ionic contents in samples might have affected the extraction efficiency of Cr(VI) ion in EME technique. Lower or non-detectable absorbances of Cr-DPC complex were observed in real samples with high ionic contents or high conductivity levels ($>20 \mu\text{S}\cdot\text{cm}^{-1}$) when using the mixture of 1-heptanol and methyltrialkylammonium chloride (aliquat 336) as the SLM. Therefore, our research focused on studying the influence of ionic contents or electrical conductivity levels in water samples on extraction efficiency of Cr(VI) ion. Various concentrations of sodium chloride (NaCl) in samples, whose conductivities were measured to represent their ionic content levels, were used. Sodium chloride (NaCl) is a common salt or ionic compound found in various foods, medical treatments, body tissue, and natural water [31]. Moreover, the optimum conditions for EME of Cr(VI) ion from high ionic content samples were evaluated.

1.2 Literature review

Sample preparation is an essential step to improve analytical performance. Several researchers have focused on development of simple, quick, effective and

low cost methods for extraction and clean-up of analytes from complex matrices. Electromembrane extraction (EME) is an interesting technique to achieve those requirements. The target analytes that have been studied are nonpolar and polar organic basic drugs, acidic drugs, and peptides. Furthermore, the technique has been applied for determination of trace level of metal ions, which mostly are cationic metals. EME concepts and configurations have been proposed to improve the extraction efficiency. Reviews of these researches are summarized as follow:

1.2.1 Literature reviews for EME of organic compounds

In 2006, Pedersen-Bjergaard and Rasmussen [6] first proposed the application of electrical potential difference on HF-LPME system to improve the transportation of charged chemical and biochemical substances, namely electromembrane isolation (EMI) or electromembrane extraction (EME). The main mechanism for isolation of the target analytes is electrokinetic migration and also passive diffusion. The setup of this method is schematically presented in Figure 1.1.

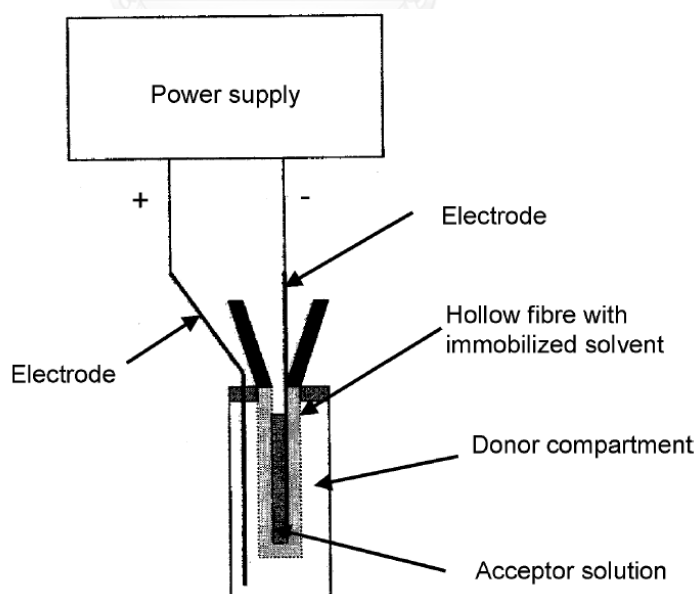

Figure 1.1 Schematic diagram of electromembrane isolation (EMI) [6]

In EME technique, the analyte must be in charged form so that it could migrate under an electric field into an acceptor solution inside the HF lumen. In case of organic basic compounds, the donor and acceptor solutions must be acidified for protonation of the basic compounds to be cationic form as shown in equation 1.1.



In case of organic acidic compounds, the donor and acceptor solutions must be adjusted for deprotonation of acidic compounds to be anionic form as shown in equation 1.2.



For this report, 5 nonpolar basic drugs, including pethidine, nortriptyline, methadone, haloperidol, and loperamide were extracted from biological samples. The basic drugs were isolated from 300 μ L aqueous donor solution containing 10 mM HCl across 2-nitrophenyl octyl ether (NPOE) serving as a supported liquid membrane (SLM) into 30 μ L aqueous acceptor solution containing 10 mM HCl. In the extraction, electric potential of 300 V was applied for 5 min. After that, a few microliters of acceptor were collected for determination by Capillary Electrophoresis (CE). The enrichment factors in the range of 7.0-7.9 and the recoveries of 70-79% were observed for all substances.

In the same year, Gjelstad et al. [14] studied EME of polar basic drugs compared with EME of nonpolar basic drugs. The conditions of donor solution, acceptor solution, electrical potential, and extraction time were the same as the previous research [6]. The organic solvent serving as SLM was the mixture of NPOE and di-(2-ethylhexyl) phosphate (DEHP), which is an ion-pair reagent. The protonated polar basic drugs were expected to form ion-pairing with DEHP enhancing

transportation of analytes into the acceptor solution. The structures of DEHP and NPOE are shown in Figure 1.2 and Figure 1.3, respectively. The method provided good recoveries (up to 83%).

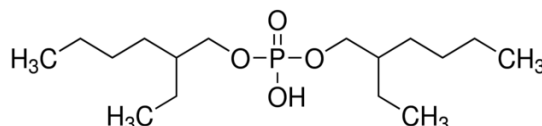

Figure 1.2 Structure of di-(2-ethylhexyl) phosphate (DEHP) [32]

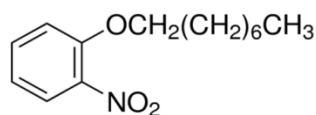

Figure 1.3 Structure of 2-nitrophenyl octyl ether (NPOE) [33]

In 2007, Balchen et al. [8] applied EME technique to extraction of 11 acidic drugs. The donor and acceptor solutions were adjusted to pH 12.0 using sodium hydroxide solution (NaOH). In this work, a long chain alcohol (1-heptanol) was considered to be a suitable solvent for acidic drugs. The system was operated under voltage of 300 V for 5 min. The recoveries between 8 and 100% were obtained for all target analytes.

In 2008, a low voltage EME using common batteries as an energy source was proposed by Kjelsen et al. [15] to save energy and cost. The electrical potential difference in the range of 1-10 V was applied over the SLM. Recoveries of 5 basic drugs from biological fluids were in the range of 37-55% after 5 min of extraction.

As shown above, many researches have attempted to improve the EME for acidic and basic drugs from various sample matrices; for example, human blood, urine, breast milk, and serum [7, 9, 11]. Moreover, some researchers have focused on EME of peptide compounds from biological fluids using different compositions of SLM, including a mixture of 2-octanone and tridecyl phosphate (90:10 w/w), a mixture of 1-octanol and DEHP (85:15, w/w), and a mixture of 1-octanol, diisobutylketone, and DEHP (55:35:10, w/w/w) [23-25].

1.2.2 Literature reviews for different concepts and setups of EME

In order to improve stability and extractability of EME technique, in 2012, Rezazadeh et al. [34] first introduced the application of pulsed voltage in combination with common constant DC power supply on EME system which was called pulsed electromembrane extraction (PEME) as shown in Figure 1.4. This new concept improved system stability by decreasing the thickness of the double layer at the interfaces and enhance extractability by eliminating this mass transfer barrier. Moreover, PEME was able to reduce a chance of bubble formation when applied to real samples. This technique provided to be better extraction ability and higher stability than the conventional EME.

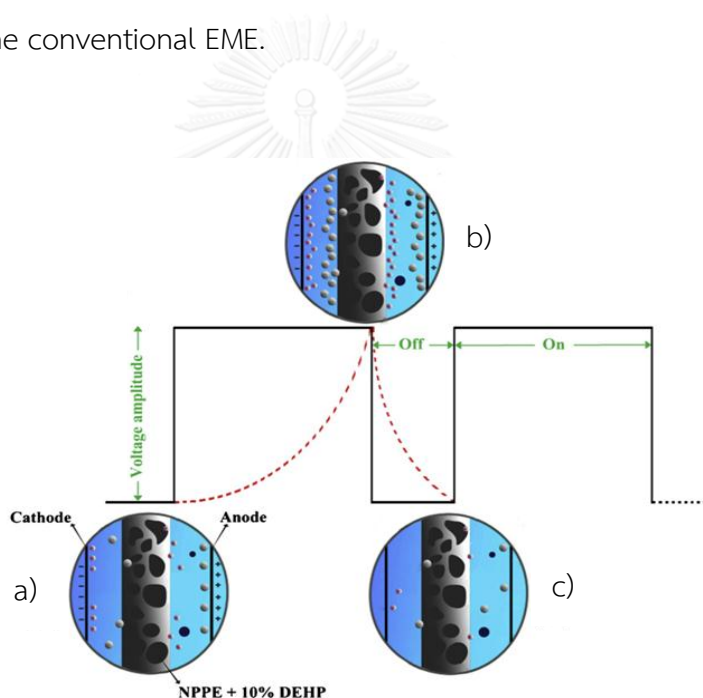

Figure 1.4 Schematic illustration of PEME setup a) at the beginning of pulse duration, b) at the end of pulse duration, and c) at the end of outage period [34]

Later, two-way PEME was a new EME aspect, which improved the selectivity of trace analysis of amino acids from foods and biological samples [35]. The two-way PEME procedure was presented in Figure 1.5. The potential difference was applied as a staircase pattern called voltage-step pulsed electromembrane extraction (VS-PEME) that gave better system stability than a constant voltage as discussed in PEME, especially when the high voltage was applied for a long time. Therefore, the better

extraction ability could be obtained [19]. These pulsed EME concepts provide good application for various target analytes in various sample matrices; for example, several basic and acidic drugs in biological samples [7, 19, 34] and amino acids in foods and biological samples [35].

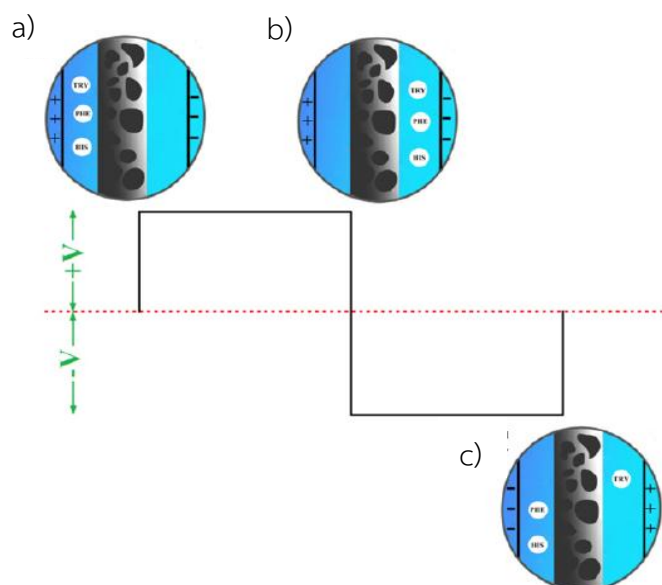

Figure 1.5 Schematic illustration of two-way PEME setup [35]

In addition, simultaneous extraction techniques of target analytes with different properties or different charges have been developed by changing EME formats. For example, Arjomandi-Behzad et al. [7] used two cathodes (with 2 pieces of hollow fiber) and 1 anode for simultaneous separation of drugs with different polar properties (atenolol; ATE) and betaxolol; BET)) by using different compositions of SLM as depicted in Figure 1.6. Moreover, Seidi et al. [20] suggested a new configuration of EME for simultaneous extraction of acidic and basic drugs. Two hollow fibers with different types of acceptor solution and SLM were used in both sides of electrodes in order to extract the cationic basic analyte and anionic acidic analyte simultaneously as presented in Figure 1.7.

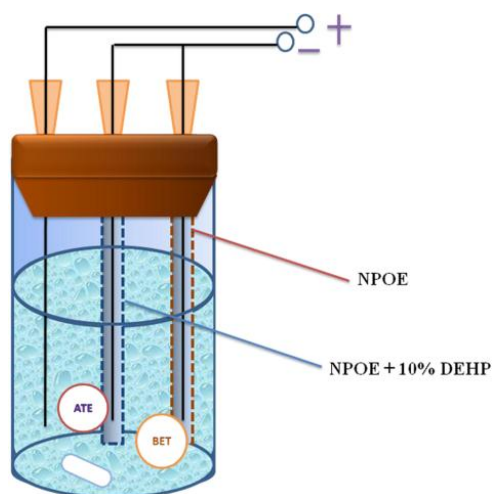

Figure 1.6 Experiment setup for simultaneous extraction of ATE and BET using two cathodes [7]

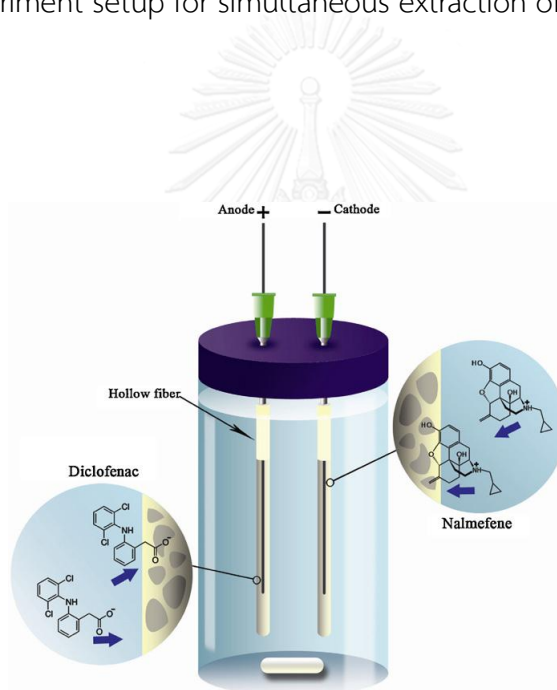

Figure 1.7 Experiment setup for simultaneous extraction of acidic and basic drugs using two hollow fibers with different SLM for anode and cathode [20]

In 2012, Eibak et al. [11] increased surface areas of organic solvent and acceptor volumes by increasing the number of hollow fibers from one to three fibers for improving extraction efficiency of basic substances as shown in Figure 1.8. Additionally, Huang et al. [36] increased the volume of acceptor solution using flat

sheet membrane as depicted in Figure 1.9. This setup provided more extractability (> 80%) for all basic drugs in human blood.

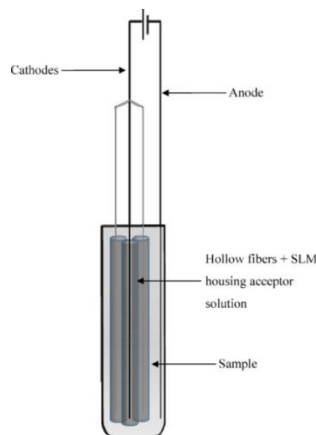

Figure 1.8 Schematic illustration of EME setup using three pieces of hollow fibers [11]

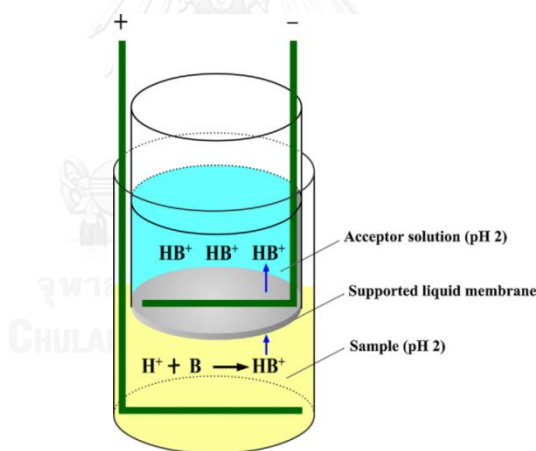

Figure 1.9 Schematic illustration of EME setup using flat sheet membrane [36]

1.2.3 Literature reviews for EME of metal ions

In 2008, Basheer et al. [26] first reported using EME technique for extraction of metal ions in cationic forms. In this work, lead ions (Pb^{2+}) were extracted from blood serum, lipstick, urine, and amniotic fluid using toluene as SLM with applied voltage of 300 V for 15 min. Limit of detection (LOD) at $0.019 \text{ mg}\cdot\text{L}^{-1}$ was observed. In 2011, Kubáň et al. [28] extracted heavy metals in cationic forms such as Mn^{2+} , Cd^{2+} , Zn^{2+} ,

Co^{2+} , Cu^{2+} , Pb^{2+} , and Ni^{2+} using EME. A mixture of 1-octanol and 0.5 %v/v DEHP was a proper organic solvent for EME of cationic metals because of the ion-exchange mechanism that could enhance the transportation of analytes across the SLM. The target analytes were extracted from samples into acidic aqueous solution (100 mM acetic acid) with an application of 75 V for 5 min.

In 2013, Davarani et al. [27] proposed the EME method for uranium(VI) ion, which was detected by fluorometric method. Good extraction performance was obtained when using NPOE mixed with 1% DEHP as organic solvent, 80 V applied voltage, 14 min extraction time, and 10^{-4} M nitric acid as the acceptor solution. Under the optimum conditions, the recoveries above 54% and enrichment factors above 65 were observed.

In 2013, Safari et al. [29] studied the speciation of chromium using dual EME procedure as illustrated in Figure 1.10. Cr(III), which is cationic form (Cr^{3+}), was extracted towards the negative electrode whereas the Cr(VI), which is anionic form ($\text{Cr}_2\text{O}_7^{2-}$), was extracted towards the positive electrode. Two hollow fiber membranes were immobilized with 1-octanol as SLM while electrodes were inserted in different acceptor solutions. An electrical potential difference of 30 V and 5 min of extraction time were applied. This method was successfully applied for the determination of Cr(III) and Cr(VI) in some water samples.

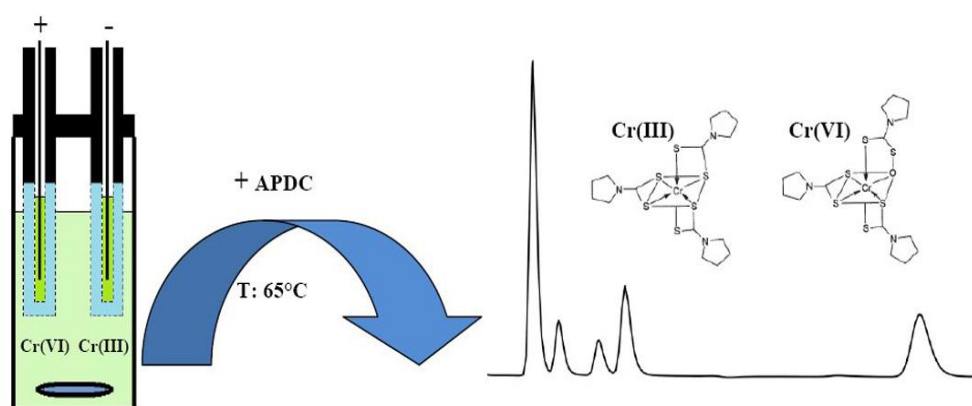

Figure 1.10 Schematic illustration of speciation of chromium by dual EME method [29]

In 2013, Chanthasakda et al. [30] studied the extraction efficiency of chromate ion using Aliquat 336 in 1-heptanol under the application of an electric field. The enrichment factor above 200 was obtained at applied voltage of 30 V and 5 min of extraction time using 1.0 M sodium hydroxide (NaOH) as the acceptor solution. Nevertheless, the extraction in some real water samples was troublesome due to the occurrence of bubbles at both sides of electrode leading to loss of acceptor solution and non-detectable results.

1.3 Aim and scope of this research

According to the literature reviews, a few applications of EME have been focused on extraction of metals in oxyanion form. Moreover, the occurrence of electrolysis and bubble formation during the extraction in real water samples was frequently noticed probably due to the presence of ionic contents. Therefore, the aim of this research is to study the effects of ionic contents in the samples on extraction efficiency of Cr(VI) oxyanions. The electrical conductivities of samples were measured to estimate their ionic contents. In the experiment, several concentrations of NaCl, which is a common salt or ionic species exists in various sources of water samples [31] were used to represent different conductivity levels in samples. Furthermore, parameters influencing EME efficiency of Cr(VI) oxyanions from ionic samples including types of extracting solvent, types of acceptor solution, applied voltage, and extraction time were investigated and optimized. Applications of this method for extraction of Cr(VI) oxyanions from real water samples such as mineral water, tap water, and natural water samples were presented.

CHAPTER II

THEORY

Sample preparation procedure is important in analytical process that could affect the overall analytical performance. This procedure plays important roles for cleanup samples and preconcentration of analytes prior to analysis by an instrument because most samples are not ready for direct injection into instruments. Additionally, the search for novel, environmental and user friendly sample preparation techniques has been challenging. The conventional steps within sample preparation are shown in Figure 2.1 [37].

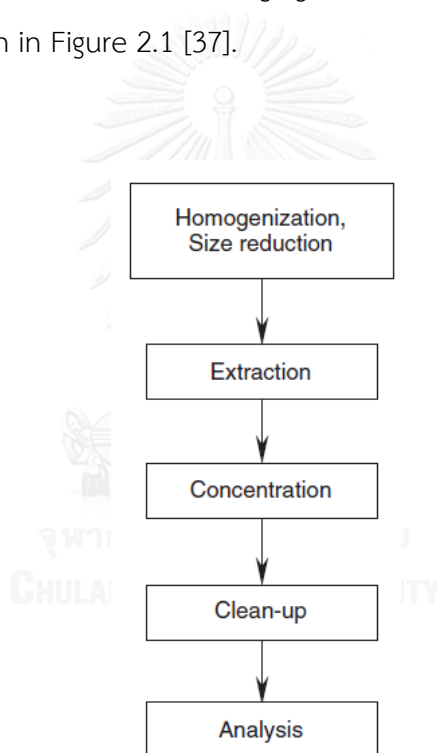

Figure 2.1 Conventional steps in sample preparation process [37]

The classical sample preparation process is liquid-liquid extraction (LLE), which is simple technique. On the other hand, LLE consumes large volume of organic solvent (milliliter level) to isolate analytes from aqueous sample with the mechanism of partitioning. So, long extraction time is required while less preconcentration factor is observed. Moreover, LLE is relatively expensive and

hazardous to environment and human health [1]. In order to avoid these drawbacks, several researchers have attempted to develop sample pre-treatment techniques that are cheap, effective, repeatable, and less time-consuming as well as consume less solvent, provide high preconcentration factors, and eliminate interferences. Liquid-phase microextraction (LPME) is a new concept that can response these requirements.

2.1 Liquid-phase microextraction (LPME)

LPME is a miniaturized LLE that has been developed for decreasing the quantities of the extracting phase and increasing the enrichment power. The general principle of LPME is the extraction of interested analytes from aqueous samples into a small volume of water-immiscible organic solvent. The analytes are transferred into the extracting phase via partition mechanism based on “like dissolve like” principle. This technique is non-exhaustive extraction. It is based on equilibrium process as illustrated below:



where A is the target analyte. The distribution coefficient, $K_{\text{org/aq}}$ is the ratio of the concentration of A in organic phase at equilibrium, $C_{\text{eq,org}}$ and the concentration of A in aqueous phase at equilibrium, $C_{\text{eq,aq}}$ as shown in Equation 2.2.

$$K_{\text{org/aq}} = \frac{C_{\text{eq,org}}}{C_{\text{eq,aq}}} \quad \text{Equation 2.2}$$

After extraction, the extraction efficiency (EE) of the target analyte is calculated by Equation 2.3.

$$EE = \frac{n_{\text{org}}}{C_i V_{\text{aq}}} \times 100 = \frac{K_{\text{org/aq}} V_{\text{org}}}{K_{\text{org/aq}} V_{\text{org}} + V_{\text{aq}}} \times 100 \quad \text{Equation 2.3}$$

where n_{org} is the amount of target analyte extracted into the organic phase, C_i is the initial concentration of the target analyte in the aqueous sample, and V_{aq} and V_{org} represent the volume of sample phase and the volume of organic phase, respectively. Besides, a parameter that indicates the preconcentration capability of LPME technique is enrichment factor (EF), which can be calculated in Equation 2.4.

$$EF = \frac{C_{\text{org}}}{C_i} = \frac{V_{\text{aq}} EE}{100 V_{\text{org}}} \quad \text{Equation 2.4}$$

where C_{org} is the concentration of the target analyte in the organic phase after extraction process [38].

There are several configurations of LPME have been reported.

2.1.1 Single drop microextraction (SDME)

Single drop microextraction (SDME) is LPME based on extraction of target analytes from aqueous samples into a microdrop of a water-insoluble organic solvent hanging at the needle tip of a microsyringe [4]. SDME is available in several modes such as direct immersion (DI)-SDME, headspace (HS)-SDME, three-phase SDME, and continuous flow microextraction [2]. For (DI)-SDME, a small drop of organic solvent suspended at the tip of a microsyringe is immersed in the stirred aqueous sample solution as shown in Figure 2.2 a). The interested analytes are extracted into the organic hanging droplet by passive diffusion mechanism. After the extraction, the droplet of extractant is withdrawn back into the microsyringe for ready to inject directly into an analytical instrument. This setup is suitable for extraction of medium polar and non-polar semi and non-volatile analytes. In case of (HS)-SDME, the extraction principle is similar to the (DI)-SDME but the droplet of organic solvent

suspended at the tip of a syringe needle is located just above the stirred and heated sample solution as illustrated in Figure 2.2 b). The droplet is collected back into the microsyringe for determination of analytes. This technique is suitable for extraction of medium polar and non-polar semi and volatile analytes. SDME reduces the consumption of hazardous organic solvents to a minimum compared to conventional LLE. Even though SDME is simple, inexpensive, and environmental friendly technique, the problem about the instability of the organic droplet is critically observed. The phenomenon leads to loss of extractant during the extraction and difficulty to operate and control. Hence, a novel idea of LPME was developed by supporting the water-immiscible organic solvent on the wall of the membrane to stabilize the organic extracting phase. This robust configuration is called hollow fiber-liquid phase microextraction (HF-LPME).

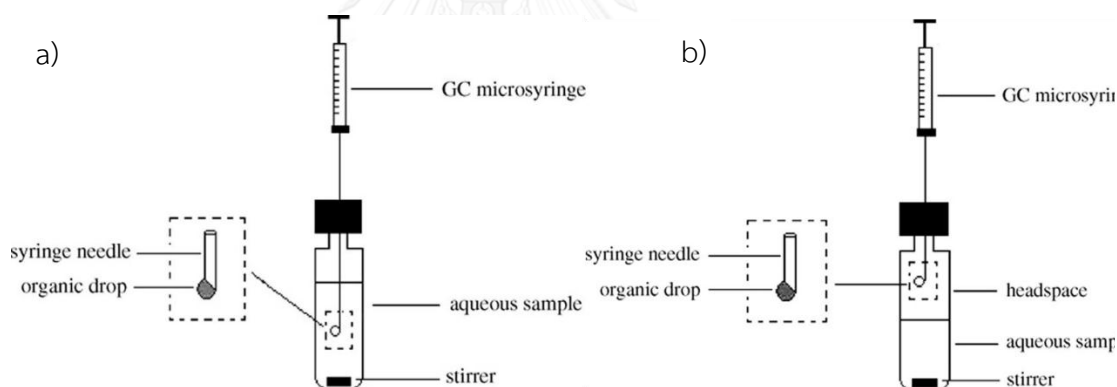

Figure 2.2 Setups of single drop microextraction (SDME); a) (DI)-SDME mode; and b) (HS)-SDME mode [39]

2.1.2 Hollow fiber-liquid phase microextraction (HF-LPME)

In HF-LPME, a porous hydrophobic hollow fiber membrane is impregnated with organic solvent to perform a thin supported liquid membrane (SLM). A hollow fiber membrane is tube like geometry, consisting lots of pores on the wall as shown in Figure 2.3. Figure 2.4 illustrates the general setup of HF-LPME. A piece of HF membrane, which is impregnated with organic solvent and filled with a small volume of acceptor solution inside the lumen, is immersed into the donor solution in the

vial. The solvent must be insoluble with water so that it would be remain in the membrane pores. For the isolation process, the interested analytes are transferred from the sample solution through the HF pores (SLM) and further into the acceptor solution via passive diffusion mechanism. After extraction, the acceptor solution is collected using a microsyringe for analysis by an analytical instrument. This configuration overcomes many disadvantages in LPME method as aforementioned in section 2.1.1.

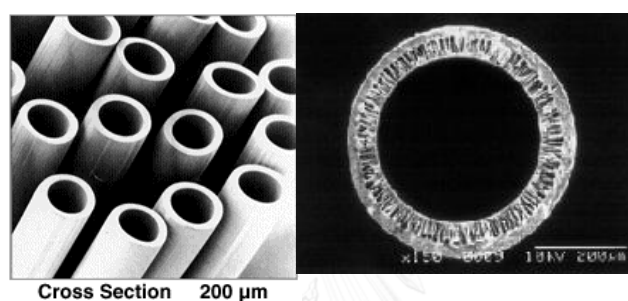

Figure 2.3 Porous hollow fiber membrane [40]

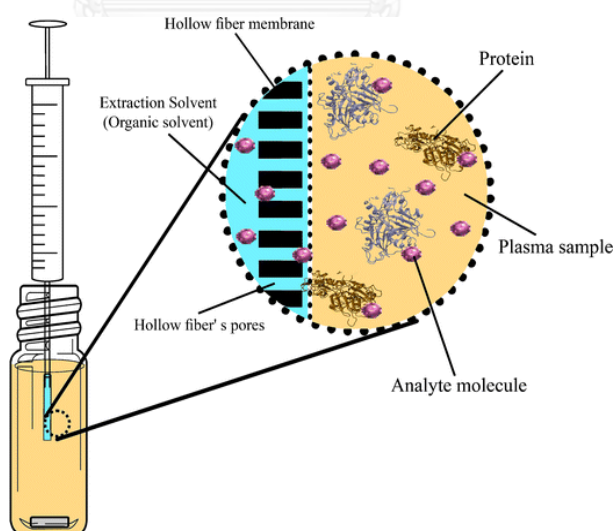

Figure 2.4 Illustration of liquid phase microextraction (LPME) [41]

HF-LPME can perform in two systems; two-phase system (Figure 2.5 a) and three-phase system (Figure 2.5 b).

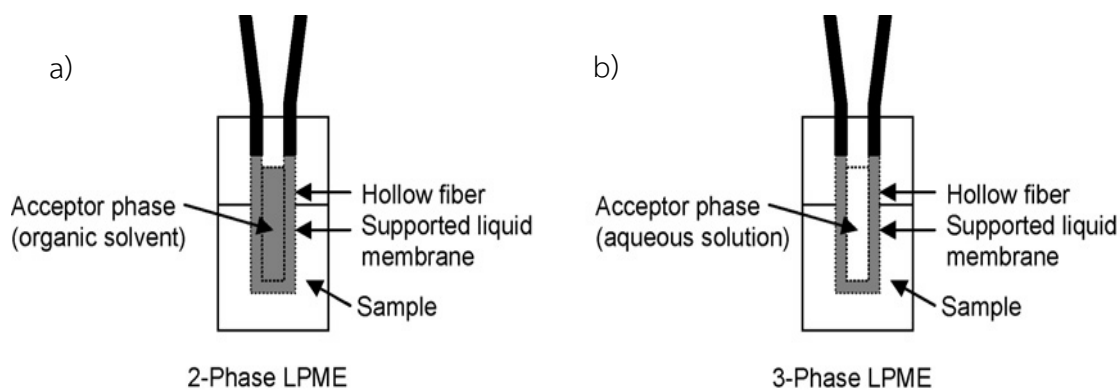

Figure 2.5 Diagrams of HF-LPME systems a) two-phase system and b) three-phase system [42]

2.1.2.1 Two-phase system of HF-LPME

In the two-phase system, the reagents that serve as SLM and acceptor are the same organic solvent. The analytes are extracted from the aqueous donor solution directly into the organic acceptor solution. The extraction process is described in Equation 2.1. The two-phase system is suitable for extraction of analytes with high solubility in non-polar organic solvents. The type of transportation is passive diffusion, which depends on the distribution coefficient ($K_{org/aq}$) of the analytes in donor and acceptor solutions. According to Equation 2.3, when the acceptor volume is low, the donor volume should be low and the distribution coefficient should be high in order to obtain high extraction efficiency. Furthermore, pH is an important factor to improve the extraction efficiency of ionizable organic compounds such as acidic and basic drugs. The pH in donor and acceptor phase must be adjusted in order to obtain non-ionic species for high partition into the extracting solvent. After extraction, the organic acceptor solution is compatible with GC and normal-phase HPLC detection. For reversed-phase HPLC analysis, the solvent should be reinstated in mobile phase prior to injection.

2.1.2.2 Three-phase system of HF-LPME

In the three-phase system, the extraction process is similar to two-phase system but the type of acceptor solution is different, that is aqueous phase. The analytes are extracted from the aqueous donor solution, through organic solvent immobilized in HF pores, which acts as a barrier between the two phases, and further into the aqueous acceptor solution inside the HF lumen. So, the three-phase system is suitable for extraction of hydrophilic or ionizable analytes. The extraction process of three-phase system is written in Equation 2.5.

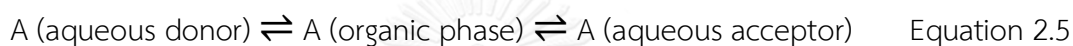

where A refers to the target analyte. In three-phase HF-LPME, the analyte distributes between the donor phase, organic phase and acceptor phase, which is related to two equilibriums between organic and donor phase ($K_{o/d}$), and between acceptor and organic phase ($K_{a/o}$), which are defined in Equation 2.6-2.8 [43].

$$K_{a/d} = K_{o/d} \times K_{a/o} = \frac{C_{eq,a}}{C_{eq,d}} \quad \text{Equation 2.6}$$

$$K_{o/d} = \frac{C_{eq,o}}{C_{eq,d}} \quad \text{Equation 2.7}$$

$$K_{a/o} = \frac{C_{eq,a}}{C_{eq,o}} \quad \text{Equation 2.8}$$

where $C_{eq,d}$, $C_{eq,o}$, and $C_{eq,a}$ represent the analyte concentration in the aqueous donor phase, organic phase, and aqueous acceptor phase at equilibrium, respectively.

The extraction mechanism of three-phase HF-LPME system is depicted in Figure 2.6. For extraction of organic acids or bases, pH is a critical driving force to enhance the extraction of organic analytes. For basic substances, the pH of donor solution should be adjusted to alkaline to get basic analytes deionized for partitioning into the organic phase, whereas other acidic compounds, which is ionized in the donor solution cannot partition into the organic phase. In the meanwhile, the pH of acceptor solution should be acidic to promote high extraction efficiency. In case of acidic substances, the donor pH should be adjusted to acidic to make analytes deionized for being extracted into the organic phase. The pH of acceptor solution is adjusted to alkaline for not allowing analytes being back-extracted into the organic phase.

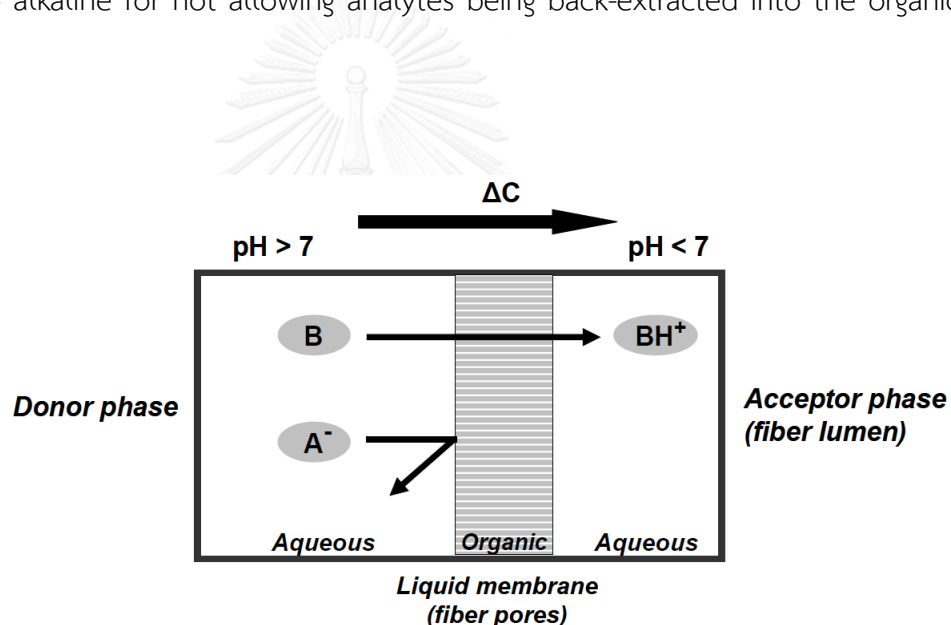

Figure 2.6 Three-phase extraction mechanism of HF-LPME for basic analytes (B = basic species, A = acidic species) [43]

Similar to two-phase HF-LPME, the preconcentration ability of three-phase systems is observed to be high when decreasing the volume ratio of donor and acceptor (V_d/V_a). After three-phase extraction, the acceptor solution can directly be analyzed by HPLC or CE technique without prior treatment.

Nonetheless, some analytes are poorly partitioned into the hydrophobic organic solvent with diffusion process alone. Thus, the extraction of highly polar

analytes or ionizable analytes cannot be achieved with both two- or three-phase modes. To solve this problem, addition of ionic carrier in the organic solvent serving as the SLM has been developed. The concept is well-known as carrier-mediated membrane transport or carrier-mediated HF-LPME [44].

2.1.2.3 Carrier-mediated HF-LPME

The HF-LPME combined with carrier contributes to the higher extraction efficiency for hydrophilic or ionic analytes because the carrier or ion-pairing agent can be formed ion-pair complex with the ionic analytes, become neutral compound, which enhance the partition ability of analytes into the organic phase. After that, the analytes can be extracted into the acceptor phase by exchanging with its counter ions in the acceptor solution at SLM/acceptor interface as described in Figure 2.7 [45].

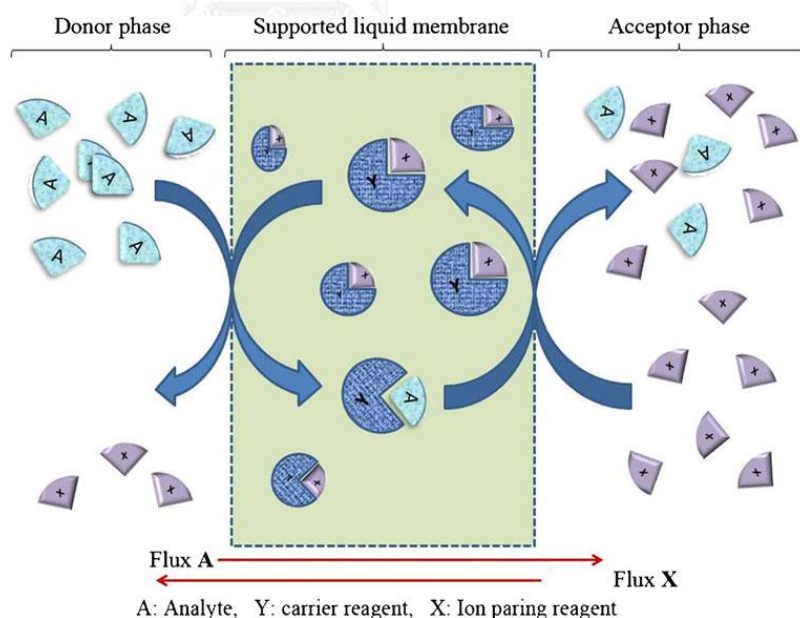

Figure 2.7 Principle of carrier-mediated HF-LPME [45]

From the literature reviews, there are various types of ionic carrier employed in HF-LPME applications, some of which are presented in Figure 2.8.

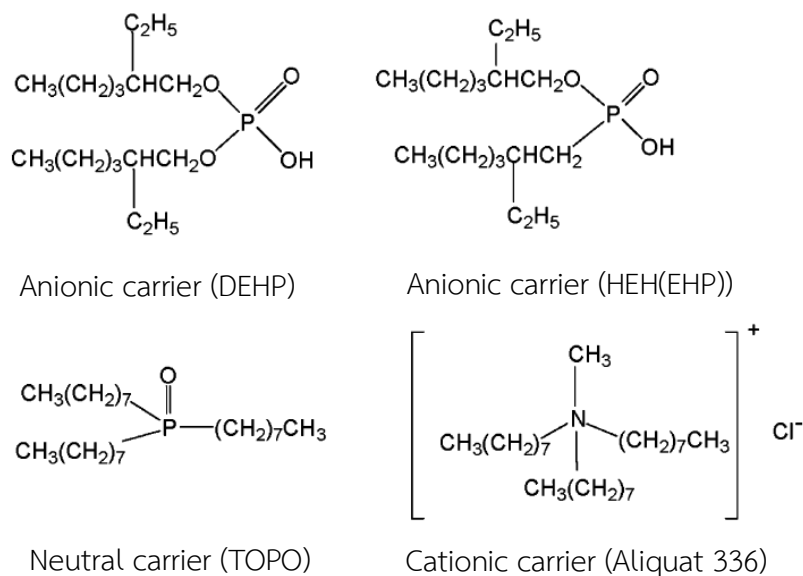

Figure 2.8 Some ionic carriers used in carrier-mediated HF-LPME [46]

The HF-LPME procedure provides good sample cleanup, low cost, stable, and very high preconcentration technique. HF-LPME offers high potential for fully automation and can be compatible with several instruments such as HPLC and CE. However, three-phase HF-LPME of ionic analytes is time-consuming typically in the range of 15-45 min. In order to overcome this disadvantage, the application of an electric field on the HF-LPME system was attempted for driving the ionic analytes into the acceptor phase. This excellent concept was first introduced in the name of electromembrane isolation (EMI) or electromembrane extraction (EME).

2.1.3 Electromembrane extraction (EME)

Electromembrane isolation (EMI) or electromembrane extraction (EME) was first introduced in 2006 as a new idea for rapid sample preparation of organic compounds in biological samples [6]. The general setup of EME is similar to the HF-LPME system but there are two platinum wire electrodes placed in donor and acceptor solutions and connected to a power supply as depicted in Figure 2.9. The mass transfer in EME is a result of both diffusion and electrokinetic components. Firstly, the analytes diffuse into the SLM. Then, the analytes are transported electrokinetically as charged

species across the SLM into the acceptor solution under the application of an electric field over the liquid membrane (SLM). The rationale for applying an electric field is to increase the extraction kinetics and reduce the extraction time.

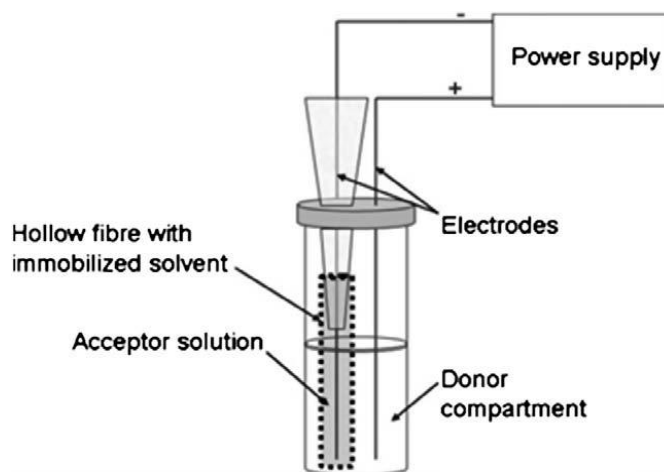

Figure 2.9 Scheme of basic EME equipment [39]

2.1.3.1 Parameters affecting EME approach

There are several important factors related to the extraction capability of the EME process and can be concluded as followed:

2.1.3.1.1 Supported liquid membrane (SLM)

The supported liquid membrane (SLM) in EME is made by impregnating the pores of the supporting material (fiber membrane) with an organic liquid. The selection of organic solvent is an essential procedure in the EME method. The decent organic solvent should be low water solubility ($<0.5 \text{ g}\cdot\text{L}^{-1}$) in order to be easily penetrated in the pores of porous polypropylene hollow fiber. In addition, the composition of SLM should provide high selectivity for interested analytes to obtain excellent extraction efficiency.

In case of hydrophobic basic compounds, the efficient organic solvents should have high dipole moments, high proton acceptor, and very low proton donor

properties, which are found in nitro-aromatic compounds and ketones such as 2-nitrophenyl octyl ether (NPOE), 1-ethyl-4-nitrobenzene (ENB), and 1-isopropyl-4-nitrobenzene (IPNB). For hydrophobic acidic compounds, the best solvents are considered to be high proton donor and low proton acceptor properties, which are aliphatic long-chain alcohol such as 1-octanol and 1-dodecanol [21]. Nevertheless, for the medium and higher polar acidic and basic compounds, addition of some ion-pairing agents is required as described in section 2.1.2.3.

Another significant consideration of the SLM in EME setup is its electrical resistance. Virtually, the SLM in EME serves as a capacitance in the electrical circuit as schematically illustrated in Figure 2.10 [47]. The lack of resistance in SLM will further boost the electrolysis reaction in both sample and acceptor solution at the electrode surfaces according to Equation 2.9 and 2.10 [8]. This phenomenon results in instability of the system, the constitution of the bubbles, loss of acceptor solution, and non-determinable results. Thus, the SLM having the suitable resistance is desired to reduce the current flow in the system [21] and to forestall the occurrence of electrolysis reaction [18, 48].

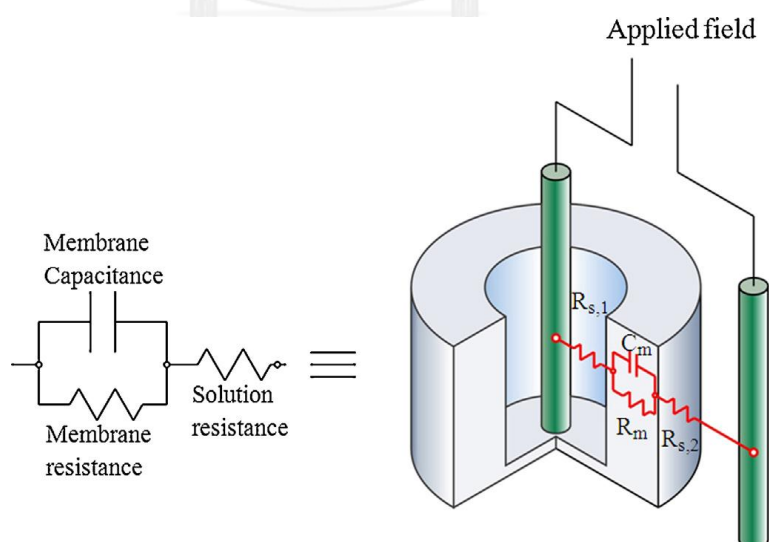
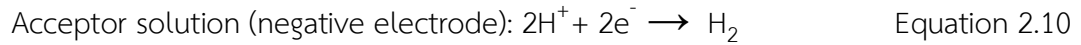
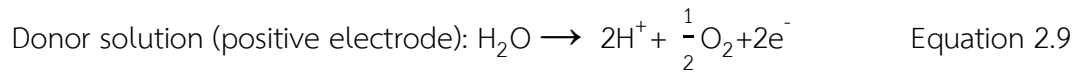

Figure 2.10 Simulated electronic circuit scheme of SLM in EME system [47]



2.1.3.1.2 Electrical potential difference

Under the electric field in EME, the applied voltage over the liquid membrane is the major driving force for moving of charged analytes into an acceptor solution with electrokinetic transportation. The strength of an electric field is increased with increasing applied voltage, which enhances the flux of analytes across the membrane. The steady-state flux of an ionic analyte across the SLM (J_i) is based upon the Nernst-Planck equation, which is defined in Equation 2.11-2.12 [49].

$$J_i = \frac{D_i}{h} \left(1 + \frac{v}{\ln x} \right) \left(\frac{x - 1}{x - \exp(-v)} \right) (C_{ih} - C_{io} \exp(-v)) \quad \text{Equation 2.11}$$

$$v = \frac{z_i e \Delta \phi}{kT} \quad \text{Equation 2.12}$$

where D_i is the diffusion coefficient of the ionic analyte; h is the membrane thickness; C_{ih} and C_{io} are the analyte concentration at the SLM/donor interface and at the acceptor/SLM interface, respectively; x is the ion balance, which is the ratio of the total ionic concentration in the donor solution to that in the acceptor solution; v is a function of applied voltage, which depends on the charged of the ionic analyte (z_i), the elementary charge (e), the Boltzman's constant (k), the potential difference ($\Delta\phi$), and the temperature (T).

According to the equations and for a given EME setup, the thickness of the SLM and the diffusion coefficient of the analyte are constant. Consequently, the flux

through the organic liquid can be improved either by increasing the potential difference across the SLM or by reducing the ion balance over the SLM.

Even though the EME recovery can be enhanced when the applied voltage is raised, there are some restrictions on increasing of the applied voltage. In some cases, the highly applied voltage may diminish the extraction recovery due to mass transfer resistance over the SLM, which is because of the rise-up of boundary layers of ionic species at both sides of SLM interfaces or the saturation of the target analytes in the acceptor solution. Hence, the extraction capability may decline by enhancing the electric field strength [15, 20, 24, 34, 50]. Nevertheless, the appropriate range of applied voltage relies on the nature of SLM, and the range becomes broader when the electrical resistance of SLM is improved. For instance, the applied voltage for the aliphatic alcohols is limited up to 100 V while NPOE can tolerate the voltage up to 300 V. The applying of voltage outside the suitable range leads to instable EME system because of an enhancement of electric current level, which can be raised by increasing the applied voltage according to Ohm's law [49].

Sum of the ion exchange current (i_{ex}) and the electrolysis current (i_e) are the current that is observed in EME system. The total current (i_t) can be calculated by Equation 2.13 [49]. The ion exchange current is occurred from two different sources, which are the migration of cationic and anionic species under an electric field across the membrane in the opposite directions and the exchange of ions between donor and acceptor phases. The electrolysis current is probably generated from the electrolysis reactions at the electrode surfaces.

$$i_t = i_{ex} + i_e \quad \text{Equation 2.13}$$

As seen in Figure 2.11, when the electric field is early applied, a double layer is suddenly generated and the condenser effect is created. This phenomenon makes the electric current in EME behave like a capacitance. At the beginning of extraction process, a short peak current is observed, followed by a gradual decrease in current

until reaching a stable level. The level of initial peak current and stable current depends on the polarities of the SLM and target analytes, applied voltage, and total concentration of ionic species in donor and acceptor phases. For example, when the electric potential of 300 V was applied over pure NPOE and mixture of NPOE with 25% (w/w) DEHP, the stabilized electric current of 5 μA and 200 μA were observed, respectively [14].

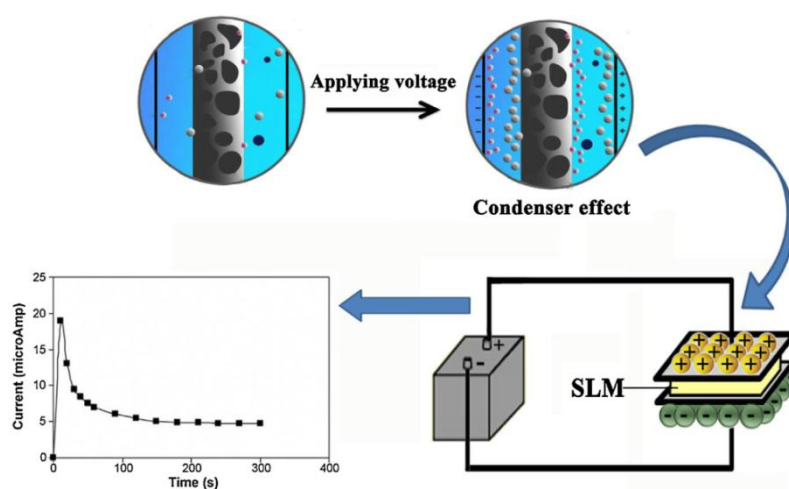

Figure 2.11 Condenser effect and electric current observed in EME technique after application of voltage [49]

Additionally, since the current declines in logarithmic pattern with time as shown in equation 2.14, the decaying time scale of real EME system can be used to calculate the exact values of membrane resistance, R_s and membrane capacitance, C_m [47]. When the voltage was applied over the membrane with a certain resistance value, the observed voltage will be different in donor solution, SLM, and acceptor solution due to their resistance differences according to Figure 2.12 [47]. From Ohm's law, the voltage drop in the solution is proportional to the magnitude of electric current with a proportionality factor of resistance. The voltage will slightly drop in the donor and acceptor solutions because of low resistance while the voltage will extremely drop in the SLM because of its high resistance, especially in organic solvents with high viscosity and high dielectric constant.

$$\tau = R_s C_m$$

Equation 2.14

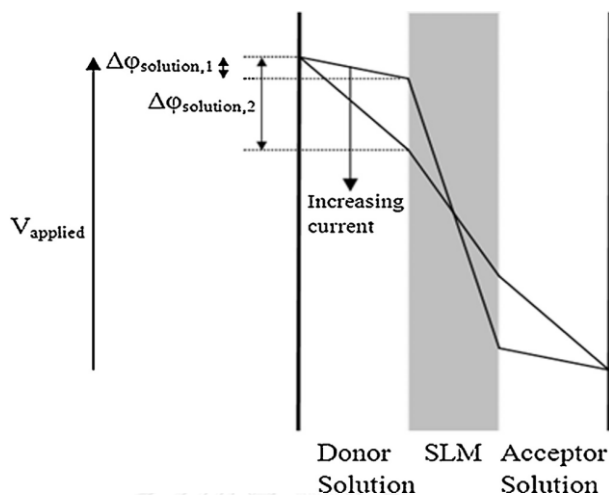

Figure 2.12 The distribution of voltage in donor, acceptor solutions and SLM, and the electric current on voltage gradient in an EME system [47]

2.1.3.1.3 Sample solution

According to Equation 2.15, in order to increase the flux of charged analytes across the SLM, the ratio of ionic strength in the sample solution to ionic strength in the acceptor solution should be reduced (low x) [51]. The increased ionic strength in the sample solution provides the increasing of electric current flow and electrolysis reaction both in the sample and acceptor solution.

Other important parameters such as pH, volume, and composition should be studied for donor solution or sample solution. The volume ratio of donor and acceptor solution ($V_{\text{donor}}/V_{\text{acceptor}}$) affects the preconcentration factors and recoveries of the target analyte. Good enrichment factor and recovery can be observed by using high quantities of donor solution or large volume ratio. In addition, the donor pH can affect the forms and species of the target analytes. In case of basic and acidic substances, the donor pH should be adjusted to be acid and alkaline, respectively

for creating their ionized form in aqueous sample solution to promote their migration through the liquid organic phase under an electric field.

2.1.3.1.4 Acceptor solution

There is the difference between the acceptor type used in two-phase and three-phase EME system. It can be defined that the acceptor type is a parameter that divides the two modes of EME operation. The acceptor phase in two-phase mode is an organic solvent whereas it is an aqueous solution in three-phase mode.

Similar to the donor phase, a rising in the ion balance in the acceptor to the sample (low x) is favorable to improve the flux over the organic liquid [51]. The three factors involving the acceptor solution, including volume, type, and composition are co-considered. The volume of acceptor should be relatively low in microliter level to be easily injected into an analytical instrument such as GC and HPLC. Besides, high enrichment factors and recoveries can be obtained by using high volume ratio of donor and acceptor phase ($V_{\text{donor}}/V_{\text{acceptor}}$). Moreover, for the EME of basic and acidic compounds, the acceptor solution should be adjusted to be acid and alkaline, respectively for ionization of the analytes in order to prevent the back-extraction of analytes into the SLM. Finally, the composition of acceptor phase should be properly chosen for the analytical method.

2.1.3.1.5 Extraction time

One of the parameters affecting the mass transfer and extractability in EME is the extraction time. The EME technique is defined as a non-exhaustive extraction technique but it gives higher extraction rate than conventional HF-LPME due to the transportation under an electric field. The extraction time is typically reduced from 45 min in HF-LPME to 5 min in EME [13]. Although the longer extraction times result in enhanced extractabilities, short time is strongly needed in practical analysis. The proper extraction time is limited by the nature of SLM as same as the applied voltage. For instance, when high applied voltage, low SLM resistance, and long extraction time are employed in the EME system, the mass transfer resistance is

reduced allowing the occurrence of the electrolysis reaction and bubble formation at the electrodes. For these reasons, extraction time must be investigated for good system stability, extractability and precision as well as high sample throughput [43].

The extraction recovery (R) and enrichment factor (EF) are calculated for the analytes of interest according to Equation 2.7 and 2.8, respectively.

2.2 Electrical conductivity

2.2.1 Principle of electrolyte electrical conductivity

Electrical conductivity (EC) or specific conductance is a measure of material's ability to conduct or carry an electric current. In case of metallic conductors, the current is carried by electrons. The current flow in an electrolyte solution is carried by ions such as chloride, nitrate, sulfate, and phosphate anions (ions that carry a negative charge) or sodium, magnesium, calcium, iron, and aluminum cations (ions that carry a positive charge) [52]. The SI unit of electrical conductivity is expressed in siemens per meter ($S \cdot m^{-1}$), which is reciprocal of electrical resistivity in ohm. The EC of a solution depends on concentration of ions (higher concentration, higher EC), temperature of solution (high temperature, higher EC), and specific nature of ions (higher specific ability or higher valence, higher EC) [53]. The EC measurements are widely used in many industrial and environmental applications as a quick, low cost, and reliable way of measuring the ionic quantity in a solution [54]. Actually, the EC links directly to the total dissolved solids concentration (T.D.S.) in the solution (following Equation 2.15 [55]) so it can be used to measure of ionizable solutes present in the sample. All ions existing in the sample refer to amounts of current flow corresponding to the conductivity of the sample, which increases when ion concentration increases.

$$\text{T.D.S. (in } mg \cdot L^{-1} \text{)} = A \times \text{EC} \quad \text{Equation 2.15}$$

where A is in the range of 0.55 to 0.9, which is varied according to chemical composition. The EC can be estimated by using the following relationship:

$$EC = \sum (C_i \times f_i) \quad \text{Equation 2.16}$$

where EC is electrical conductivity (in $\mu\text{S}\cdot\text{cm}^{-1}$); C_i is the concentration of ionic specie i in the solution (in $\text{mg}\cdot\text{L}^{-1}$), and f_i is the conductivity factor of ionic specie i (in $\mu\text{S}\cdot\text{cm}^{-1}$ per $\text{mg}\cdot\text{L}^{-1}$). The conductivity factors of major ions found in several water sources are shown in Table 2.1.

Table 2.1 Conductivity factors of some common ions at 298 K [53]

Cations	Conductivity factor ($\mu\text{S}\cdot\text{cm}^{-1}$ per $\text{mg}\cdot\text{L}^{-1}$)	Anions	Conductivity factor ($\mu\text{S}\cdot\text{cm}^{-1}$ per $\text{mg}\cdot\text{L}^{-1}$)
Ca^{2+}	2.60	HCO_3^-	0.715
Mg^{2+}	3.82	Cl^-	2.14
K^+	1.84	SO_4^{2-}	1.54
Na^+	2.13	NO_3^-	1.15

The ranges of conductivity of some waters used in laboratory and environment are shown in Table 2.2.

Table 2.2 General conductivity of waters at 298 K [56]

Waters	Electrical conductivity ($\mu\text{S}\cdot\text{cm}^{-1}$)
Ultrapure water	0.055
DI water	0.1
Distilled water	0.5
RO water	50-100
Domestic tap water	500-800
Ground water	30-2,000
Industrial wastewater	$\geq 5,000$
Sea water	56,000

Remark: Because of self-ionization of water into H^+ and OH^- ions, the electrical conductivity of ultrapure water is non-zero ($\text{EC} = 0.055 \mu\text{S}\cdot\text{cm}^{-1}$ at 298 K).

2.2.2 Measurement of electrical conductivity

An electrical conductivity of solution can be directly measured by the conductivity meter. In the measurement, a voltage is applied between two fixed inert electrodes of known surface area as a probe immersed in a solution as seen in Figure 2.13. Decreasing in voltage caused by the resistance of solution is converted to the conductivity.

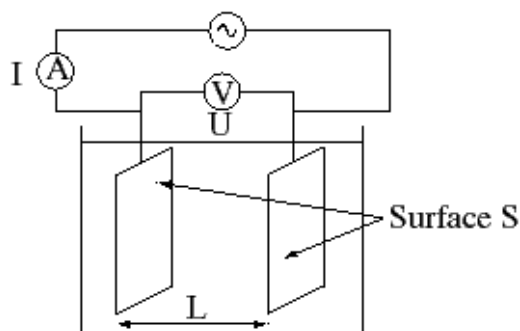

Figure 2.13 General principle of conductivity measurement [57]

2.2.3 Relationship between electrical conductivity and ionic strength

The ionic strength (I) is a function of concentration and charge of all charged species containing in a solution. It can be determined by the actual or known water composition as described in Equation 2.17.

$$I = \frac{1}{2} \sum_i z_i^2 C_i \quad \text{Equation 2.17}$$

where I is the ionic strength in a solution ($\text{mol}\cdot\text{L}^{-1}$); z_i is the oxidation number (or charge) of ions, and c_i is the concentration of ions in the solution. Nevertheless, the conductivity, salinity, and T.D.S. are related to the ionic strength. Electrical conductivity (EC) is also proportional to the concentration of ions in the solution. The linear relationship between EC and ionic strength can be written in Equation 2.18.

$$EC = 6.2 \times 10^4 \times I \quad \text{Equation 2.18}$$

The ionic strength is seldom directly calculated due to the unpredictable ion species existing in the solution so the ionic strength in the unknown sample should be evaluated from the EC value, which is directly measured from the conductivity meter as seen below (reverse from Equation 2.18) [58]:

$$I = 1.6 \times 10^{-5} \times EC \quad \text{Equation 2.19}$$

2.3 Chromium

Chromium is widely distributed in the earth. Chromium exists in various oxidation numbers of +2 to +6. The several forms of chromium are considered toxic and carcinogenic compounds. In this research, Cr(VI) ion is selected as a model

analyte because of its high toxicity. The United States Environmental Protection Agency (U.S. EPA) and the World Health Organization (WHO) have set the maximum contaminant level (MCL) of Cr(VI) in natural, tap and drinking water at $50 \mu\text{g}\cdot\text{L}^{-1}$ [59, 60].

2.3.1 Properties and health effects

Typically, chromium found in natural water has two oxidation states that are trivalent chromium Cr(III) and hexavalent chromium Cr(VI).

Trivalent chromium is positive ion that exists in the environment and in various kinds of food such as vegetables, fruits, and meat. In a solution, Cr(III) is more stable, less soluble, and less mobile than Cr(VI). Moreover, it is suggested that Cr(III) is not significant health risk [61].

Hexavalent chromium has been available in three common anion forms that are dichromate ion ($\text{Cr}_2\text{O}_7^{2-}$), chromate ion (CrO_4^{2-}), and hydro chromate ion (HCrO_4^-). Their chemical structures can be seen in Figure 2.14. The distribution of those three chromium species in a solution depend on the solution pH, the fraction of Cr(VI), and the redox potential [62] as illustrated in Figure 2.15. According to the literature reviews [63], chromate ion (CrO_4^{2-}) exists in relatively basic solution ($\text{pH} > 7$) whereas dichromate ion ($\text{Cr}_2\text{O}_7^{2-}$) and hydro chromate ion (HCrO_4^-) prevail in relatively acidic solution. In addition, their distribution ratios rely on the total concentration of Cr(VI). For examples, $\text{Cr}_2\text{O}_7^{2-}$ changes to HCrO_4^- at total concentration of Cr(VI) lower than $(1.26\text{--}1.74) \times 10^{-2}$ M while $\text{Cr}_2\text{O}_7^{2-}$ is the major forms at higher concentrations of Cr(VI). The equilibriums of three Cr(VI) forms in aqueous solution are written in Equation 2.20.



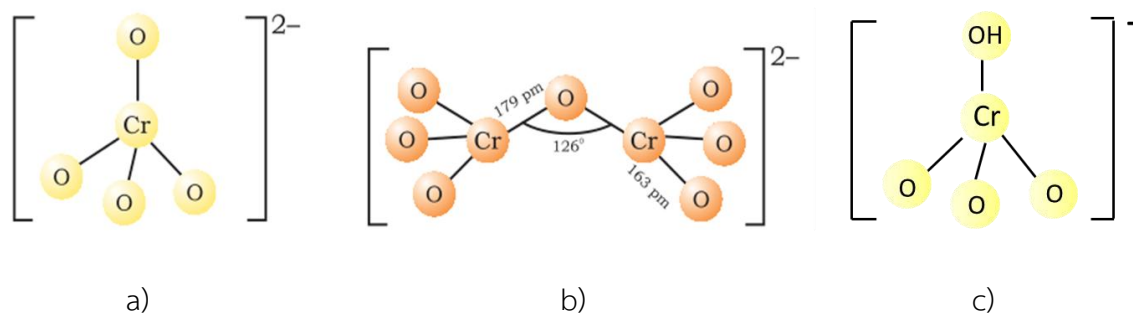

Figure 2.14 Chemical structures of chromium(VI): a) chromate ion (CrO_4^{2-}), b) dichromate ion ($\text{Cr}_2\text{O}_7^{2-}$), and c) hydrochromate ion (HCrO_4^-)

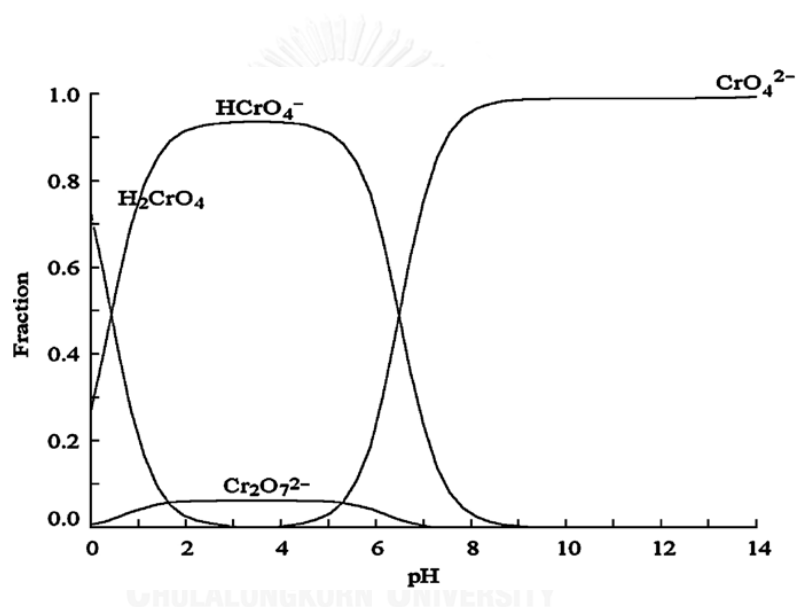

Figure 2.15 Speciation diagram of chromium(VI) at distinct pH [63]

In this trial, the total concentration of Cr(VI) in the initial sample solution is lower than $(1.26-1.74) \times 10^{-2}$ M, thus we assume that Cr(VI) exists mainly in HCrO_4^- anion form, whereas only a small fraction of $\text{Cr}_2\text{O}_7^{2-}$ coexisted also in the aqueous sample.

Anthropogenic activities such as plating industry, dyes and pigments production, wood preservation, as well as the manufacture of steel and iron may cause the contamination of Cr(VI) in drinking water. Cr(VI) is the dangerous form of chromium, approximately 10-100 times more than Cr(III). When it enters human body,

it can cause nausea, gastrointestinal afflict, stomach lesions, skin injuries, allergic reactions, kidney and liver damage, metabolic acidosis, lung and nasal cancer [61]. Consequently, the amounts of Cr(VI) in different water sources are necessary to be controlled under the regulated level.

2.3.2 Colorimetric method for determination of Hexavalent chromium

In 1992, the United States Environmental Protection Agency (U.S. EPA) [64] recommended the EPA method 7196A for quantifying of dissolved hexavalent chromium in characteristic extracts and ground waters. This colorimetric method can also be applied to certain domestic and industrial wastes with no interfering substances effects. In addition, the method 7196A may be used to analyze samples containing Cr(VI) in the range of 0.5 to $50 \text{ mg}\cdot\text{L}^{-1}$.

For the determination of Cr(VI) via spectrophotometric method, the Cr(VI) is reacted with excess 1,5-diphenylcarbazide (DPC) in acidic solution ($\text{pH } 2 \pm 0.5$) to form Cr-DPC complex with red-violet color, which will absorb the visible light at 544 nm. The reaction mechanism is depicted in Figure 2.16. Cr(VI) is first reduced to Cr(III) by DPC. Then, the Cr(III) will react with the oxidized form of DPC (or 1,5-diphenylcarbazone) to become Cr(III)-1,5-diphenylcarbazone complex (Cr-DPC complex), which gives the red-violet color [30]. The maximum holding time (after extraction) prior to analysis of samples and extracts is 24 hrs. [64].

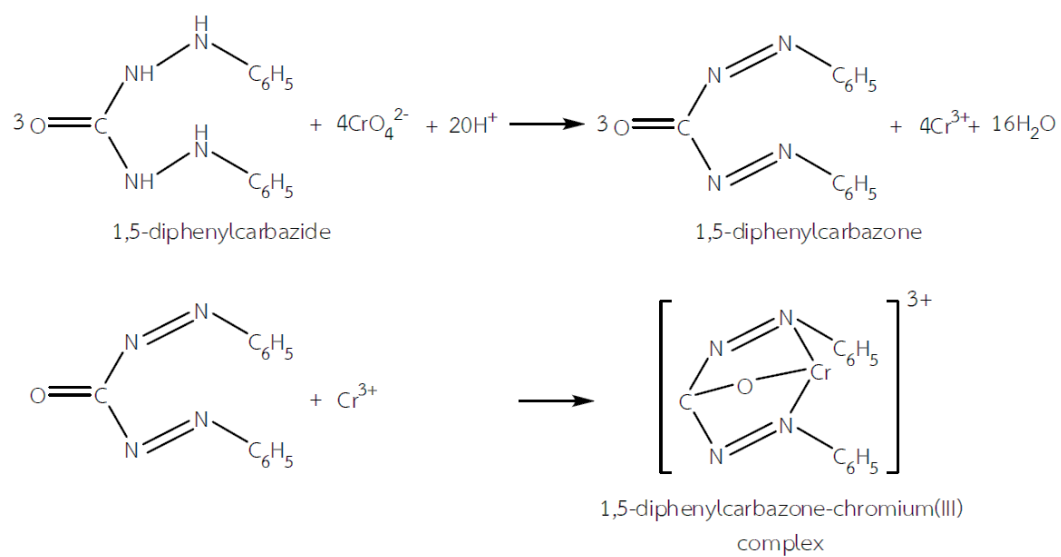

Figure 2.16 Hexavalent chromium calorimetric method [65]



CHAPTER III

EXPERIMENTAL

3.1 Instruments and materials

1. DC power supply 330 W, 0-110 V, 0-3 A (GPR-11H30D): Electronics Source Co., Ltd. (Bangkok, Thailand)
2. Conductivity meter (CM-115): Kyoto Electronics (Kyoto, Japan)
3. Fiber optic UV-Vis spectrometer (USB4000) with Z-flow cell: Ocean Optics (Dunedin, FL, USA)
4. Milli-Q ultra-pure water system: model Millipore ZMQS5V00 (Massachusetts, USA)
5. Multi-station magnetic stirrer: model RCT basic IKAMAG®, IKA® Werke GmbH & Co. KG (Staufen, Germany)
6. Multimeter (UNI-T UT55): Transfer Multisort Elektronik Sp. z o. o. (Lodz, Poland).
7. Magnetic stirring bars: Spinbar (Wayne, NJ, USA)
8. Ultrasonicate: model crest575d, Crest Ultrasonic Corporation (New York, USA)
9. pH meter: METTLER TOLEDO (Greifensee, Switzerland)
10. Micro-porous polypropylene hollow fiber membrane Accurel® PP Q3/2, 600 μm i.d., 200 μm thickness, and 0.2 μm pore size: Membrana (Wuppertal, Germany)
11. Platinum wire, 0.20 mm diam., $\geq 99.99\%$ metals basis: Sigma-Aldrich (St. Louis, MO, USA)
12. Microsyringe, 50 μL : Hamilton Company (Nevada, USA)
13. Medical syringes, 3 mL: Becton Dickinson Medical (S) (Tuas, Singapore)

14. Medical syringe needles, 500 μm O.D.: Becton Dickinson Medical (S) (Tuas, Singapore)
15. EPA vial Kit, 30 mL: vertical chromatography (Bangkok, Thailand)
16. Insert glass vial, 300 μL : vertical chromatography (Bangkok, Thailand)
17. Micropipettes, 10-100 μL , 100-1000 μL , and 1-10 mL: Eppendorf (Hamburg, Germany)
18. Micropipette tips, 200 μL , 1000 μL and 10 mL: Eppendorf (Hamburg, Germany)
19. Volumetric flasks, 5.00 mL, 10.00 mL, 25.00 mL, 50.00 mL, 100.00 mL, 250.00 mL, 500.00 mL and 1000.00 mL
20. Solvent bottles, 25 mL, 100 mL, 500 mL, and 1000 mL
21. Beakers, 10 mL, 50 mL, 100 mL, 500 mL, and 1000 mL

All glasswares were immersed in 5% HNO_3 for more than 5 hours and cleaned with detergents and rinsed with deionized water before uses.

3.2 Chemicals and reagents

1. Potassium dichromate: BDH Chemicals (Poole, England)
2. Sodium chloride (99.5%): Carlo erba (Rodano, Italy)
3. Sodium hydroxide ($\geq 99\%$): Merck (Darmstadt, Germany)
4. 1,5-diphenylcarbazide: Sigma-Aldrich (St. Louis, MO, USA)
5. 2-Nitrophenyl octyl ether (99%): Sigma-Aldrich (St. Louis, MO, USA)
6. 1-heptanol (99%): Sigma-Aldrich (St. Louis, MO, USA)
7. 1-octanol (99%): Sigma-Aldrich (St. Louis, MO, USA)
8. Methyltrialkylammonium chloride (aliquat 336, 99%): Merck (Darmstadt, Germany)

9. Tris (hydroxymethyl)-aminomethane Carlo erba (Rodano, Italy)
10. Ethanol: Merck (Darmstadt, Germany)
11. Sulfuric acid 100%: J.T. Baker (Deventer, Netherlands)
12. Nitric acid 65%: Merck (Darmstadt, Germany)
13. Acetic acid 100%: Merck (Darmstadt, Germany)

3.3 Preparation of chemical solutions

3.3.1 Stock potassium dichromate solution

A 1000 mg·L⁻¹ standard solution of Cr(VI) was prepared by dissolving 0.0707 g of potassium dichromate (K₂Cr₂O₇) in 25.00 mL volumetric flask with milliQ water. The stock standard solution was stored in polypropylene vial with screw cap at 4 °C in a refrigerator until use.

3.3.2 Sodium chloride solution (NaCl); 1 M and 0.5 M

A 1 M stock solution of NaCl was prepared by dissolving 5.844 g of NaCl in 100.00 mL volumetric flask with milliQ water and kept in closed polypropylene vial in a refrigerator. A 0.5 M solution of NaCl was obtained by pipetting 5.00 mL of 1 M NaCl into a 10.00 mL volumetric flask and diluting with milliQ water.

3.3.3 Sample solutions

Solutions of 20 µg·L⁻¹ Cr(VI) in 0, 1.0, 2.5, and 5.0 mM NaCl were prepared by mixing 100 µL of 100 mg·L⁻¹ of K₂Cr₂O₇ and 0.00, 0.50, 1.25, and 2.50 mL of 1 M NaCl in 500.00 mL volumetric flask with milliQ water, respectively.

3.3.4 1,5-diphenylcarbazide (DPC) solution; 6 mM

A 6 mM solution of DPC was prepared everyday by dissolving 0.0145 g of DPC in 10.00 mL volumetric flask with ethanol. The DPC solution was stored in amber glass vial with screw cap until use.

3.3.5 Sulfuric acid (H₂SO₄) solution; 100.0 mM

A 100.0 mM solution of H₂SO₄ was prepared by pipetting 250 μ L of 4.0 M H₂SO₄ into a 10.00 mL volumetric flask and diluting with milliQ water. The 4.0 M H₂SO₄ was prepared by diluting 10.66 mL of concentrated H₂SO₄ solution in 50.00 mL volumetric flask with milliQ water.

3.3.6 Acetic acid solution (HOAc); 1 M and 0.5 M

A 1 M stock solution of HOAc was prepared by diluting 28.60 mL of concentrated HOAc in 500.00 mL volumetric flask with milliQ water and kept in closed glass vial at room temperature. A 0.5 M solution of HOAc was prepared by pipetting 5.00 mL of 1 M HOAc into a 10.00 mL volumetric flask and diluting with milliQ water.

3.3.7 Acetate buffer solution; 1 M

A 1 M stock solution of acetate buffer was prepared by mixing 76.50 mL of 1 M sodium acetate anhydrous (CH₃COONa) and 423.50 mL of 1 M acetic acid (HOAc) in a 500.00 mL volumetric flask. A 1 M of CH₃COONa was prepared by dissolving 8.2080 g of CH₃COONa in a 100.00 mL volumetric flask with milliQ water.

3.4 Experimental

3.4.1 Electromembrane extraction procedure

A three-phase EME set-up is schematically presented in Figure 3.1. A 30 mL glass vial was used to contain 28 mL of Cr(VI) sample solution. A 5-cm piece of hollow fiber membrane was immersed in an organic solvent (SLM) for 10 seconds. The excess organic solvent in the lumen of the membrane was gently flushed with an air blow for a few times. Then the lumen was filled with 13 μL of an acceptor solution. The membrane was sealed at one end by a heating sealer. The hollow fiber was single used to prevent carry-over. Two 4.5 cm lengths of 0.2 mm ID platinum electrodes were used. One was placed in the sample solution (negative electrode) and the other one was put in the acceptor solution (positive electrode) inside the lumen of the membrane. Both electrodes were connected to a power supply. After extraction, a 10 μL of the acceptor solution was collected by a microsyringe and delivered into an insert glass vial for detection.

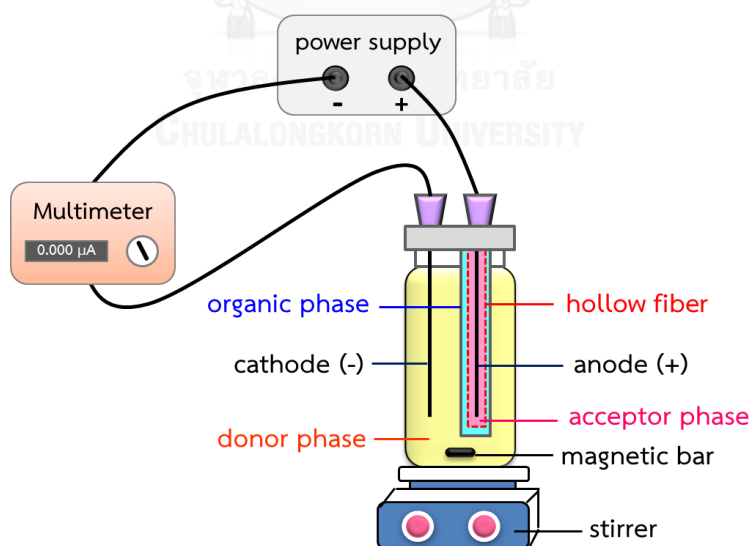

Figure 3.1 Schematic set-up of electromembrane extraction system

3.4.2 Detection of chromium(VI) by colorimetric method

Cr(VI) can be determined by forming complex with 1,5-diphenylcarbazide (DPC) in the acidic condition (pH 2). The extract was mixed with 30 μL of 6 mM DPC solution and 10 μL of 100 mM H_2SO_4 solution according to the literature [66]. The mixed solution was red-violet color and was detected by UV-Vis spectrophotometer at 544 nm.

3.4.3 Effect of ionic contents in samples (sample electrical conductivities) on electromembrane extraction efficiency of Cr(VI)

3.4.3.1 Type of SLM

Type of SLM was considered to be the most significant factor affecting the EME efficiency of Cr(VI) in sample with different conductivities. So, it must be investigated. Various types of organic solvent using as SLM such as 5% aliquat 336 in 1-heptanol, 1-heptanol, 1-octanol, and NPOE were studied according to different polarities, viscosities, and dielectric constants.

3.4.3.2 Preliminary study of acceptors for chosen SLMs

In comparison of EME efficiency of Cr(VI) using different types of SLM, acceptor type could have affected the extraction efficiency and should be preliminarily studied. The acceptor solutions that could facilitate the transportation of Cr(VI) ion from the SLMs were studied. Several types of acceptor solutions such as milliQ water, 0.5 M NaCl, 0.5 M NaOH, 0.1 M H_2SO_4 , and 0.1 M HOAc, were chosen according to the literature reviews. The extraction was preliminarily studied using 50 $\mu\text{g}\cdot\text{L}^{-1}$ Cr(VI) solution. The appropriate acceptor solution that was applicable for extraction of Cr(VI) using all of the SLMs, would be further studied the effect of sample conductivities on EME of Cr(VI).

3.4.3.3 Effect of sample conductivities on electromembrane extraction profiles of Cr(VI)

In this study, the electrical conductivity in sample was considered as a critical factor on the efficiency of EME technique because it can increase a chance of electrolysis and bubble formation at electrodes. Therefore, this effect was evaluated using $20 \mu\text{g}\cdot\text{L}^{-1}$ Cr(VI) solutions in various concentrations of sodium chloride (0.0, 1.0, 2.5 and 5.0 mM) to represent samples with various levels of ionic contents. The electrical conductivities were about 1, 120, 310 and $630 \mu\text{S}\cdot\text{cm}^{-1}$, respectively. Various types of organic solvent, including 5% aliquat 336 in 1-heptanol, 1-heptanol, 1-octanol, and NPOE were examined. The voltages were applied in the range of 0-50 V whereas the extraction times were investigated ranges from 1-30 min for each level of sample conductivity. The extraction efficiency at each experimental condition has been displayed as enrichment factor, which is a ratio of the final concentration of Cr(VI) ion in the acceptor solution to the initial concentration of Cr(VI) ion in the donor solution. The extraction profiles of Cr(VI) ion in samples with various conductivities at various SLM types, applied voltages, and extraction times were established. In addition, the current-time profiles of each condition were monitored in order to describe the system instability.

3.4.4 Optimization of electromembrane extraction of Cr(VI) from samples with high conductivity

Conditions for electromembrane extraction of Cr(VI) in samples with high conductivities (5.0 mM NaCl , $630 \mu\text{S}\cdot\text{cm}^{-1}$) were optimized. Several influential parameters affecting extraction efficiency including type of organic solvent, sample pH, acceptor type, applied voltage and extraction time were examined. The results were reported as enrichment factors in order to evaluate the method efficiency.

3.4.4.1 Type of organic solvent

Type and composition of organic solvent is the most important parameter influencing the extractability; therefore, it must be tuned. In this study, pure organic solvent (1-heptanol, 1-octanol, and NPOE), mixture of pure organic solvent (NPOE : 1-heptanol = 90 : 10 and NPOE : 1-octanol = 90 : 10), and mixture of ion carriers and pure organic solvent (5% aliquat 336 in NPOE and 5% DEHP in NPOE) were studied.

3.4.4.2 Sample pH

The sample pH could affect forms of Cr(VI) species and transportation ability across the liquid membrane. In this work, the sample pH was adjusted to pH 4 using HCl and acetate buffer; pH 7 using NaOH and phosphate buffer; and pH 10 using NaOH and borate buffer. Moreover, the concentrations of appropriate buffer in the sample solution were further investigated.

3.4.4.3 Acceptor type

Various types of acceptor solutions were tuned for samples with high conductivities, including H_2SO_4 , HOAc, HCl, milliQ water, NaCl, NaOH, and NH_3 , at the same concentration of 0.1 M. Moreover, the concentrations of selected acceptor were investigated for the best extraction capability.

3.4.4.4 Applied voltage

According to Nernst-Planck flux equation, the migration ability of the analytes can be enhanced by rising of applied voltage. For the optimization, applied voltages of 0, 10, 30, 50, and 100 V were studied.

3.4.4.5 Extraction time

The extraction times in the range of 1-30 min were studied and optimized for practical analysis.

3.4.5 Method evaluation

3.4.5.1 Calibration curve and linearity

Standard calibration curve was carried out by spiking Cr(VI) standard solution at various concentrations in solution containing 5.0 mM NaCl and extracted with EME under optimized conditions. Each concentration level was studied at three replicates. The calibration curves were plotted between the absorbance value and the concentration of Cr(VI). The slope, y-intercept, and correlation coefficient (R^2) of Cr(VI) are used to represent the linear regression of the proposed method.

3.4.5.2 Limit of detection (LOD) and limit of quantification (LOQ)

The limit of detection (LOD) refers to the lowest concentration of the analyte that can be detected by the method, while the limit of quantitation (LOQ) is the lowest concentration of the analyte that can be quantitatively determined. The LOD and LOQ are calculated from Equation 3.1 and 3.2, respectively.

$$S_{\text{LOD}} = S_B + 3SD \quad \text{Equation 3.1}$$

$$S_{\text{LOQ}} = S_B + 10SD \quad \text{Equation 3.2}$$

where S_{LOD} and S_{LOQ} are the signal at limit of detection and at limit of quantitation; S_B is the blank signal, and SD is the standard deviation of regression line, which was obtained from Equation 3.3.

$$SD = \sqrt{\frac{\sum (y_i - Y_i)^2}{n-2}} \quad \text{Equation 3.3}$$

where y_i and Y_i are the signals of the analyte obtained from the experiment and from linear regression equation, respectively at each standard concentration; n is the number of concentrations of standard solutions used to establish the linear regression line.

3.4.5.3 Enrichment factor

Enrichment factor is calculated from the ratio of the final concentration in acceptor solution and the initial concentration in blank sample as seen in Equation 3.4.

$$EF = \left(\frac{C_{a,final}}{C_{d,initial}} \right) \quad \text{Equation 3.4}$$

where $C_{a,final}$ and $C_{d,initial}$ are the analyte concentration in the sample and acceptor solution, respectively.

3.4.5.4 Accuracy

The method accuracy is the closeness of agreement between the observed quantities of the analyte from the method and the true value or accepted reference

value of the analyte in the sample [67, 68]. Accuracy was derived from the extraction of analyte spiked in the blank sample using optimum EME parameters. In this research, the spiked blank water samples were analyzed for three replicates at two spiking levels: 20, and 50 $\mu\text{g}\cdot\text{L}^{-1}$. The ratio between observed concentration and spiked concentration was expressed as recovery percentages of Cr(VI), which refers to the accuracy of the method.

3.4.5.5 Precision

The precision is the closeness of agreement between independent test results obtained under the same condition. Two categories of precision are intra-day precision and inter-day precision. The intra-day precision is achieved from repeated trials on the same method within a day, while the inter-day precision is carried out from repeated trials on the same method in different days. In this work, intra-day precision was conducted for eight replicates of spiked blank samples at 20 $\mu\text{g}\cdot\text{L}^{-1}$ within the same day. Inter-day precision was conducted for three replicates of spiked blank samples at 20 $\mu\text{g}\cdot\text{L}^{-1}$ for five consecutive days (n=15 overall). The percent of relative standard deviations (%R.S.D.) of the enrichment factor were calculated for each category.

3.4.5.6 Matrix effect

The matrix effect was evaluated by extraction of water samples with various matrices spiked with Cr(VI) at 20 $\mu\text{g}\cdot\text{L}^{-1}$. The enrichment factors were compared.

3.4.6 Application of the optimized EME method to real water samples

Drinking water and mineral water samples were purchased from convenient stores in Bangkok, Thailand. Surface water samples were collected from *Kaeng Krachan Dam*, Phetchaburi and from a pond located in Chulalongkorn University, Bangkok. The samples were filtered through a membrane filter with 0.45 μm pore

size to remove some colloids and sediments before extraction. The conductivities were measured. Matrix match calibration curves were also established. Linearity, LOD, LOQ and matrix spiked recoveries were reported.



CHAPTER IV

RESULTS AND DISCUSSION

4.1 Preliminary study of acceptors for chosen SLMs

The acceptor compositions were primary examined for extraction of Cr(VI) in a solution by using different pure organic solvents (1-heptanol, 1-octanol, and NPOE) as the SLM. Acceptors that were used for this study were milliQ water, 0.5 M NaCl, 0.5 M NaOH, 0.1 M H₂SO₄, and 0.1 M HOAc. Figure 4.1 shows the extraction performance of Cr(VI) from MilliQ water using the acceptors with different types of SLM. The results show that 0.5 M NaCl and 100 mM acetic acid were able to facilitate the transportation of Cr(VI) ions from all kinds of SLM. Because 0.5 M NaCl provided better extraction, 0.5 M NaCl was chosen for the following study.

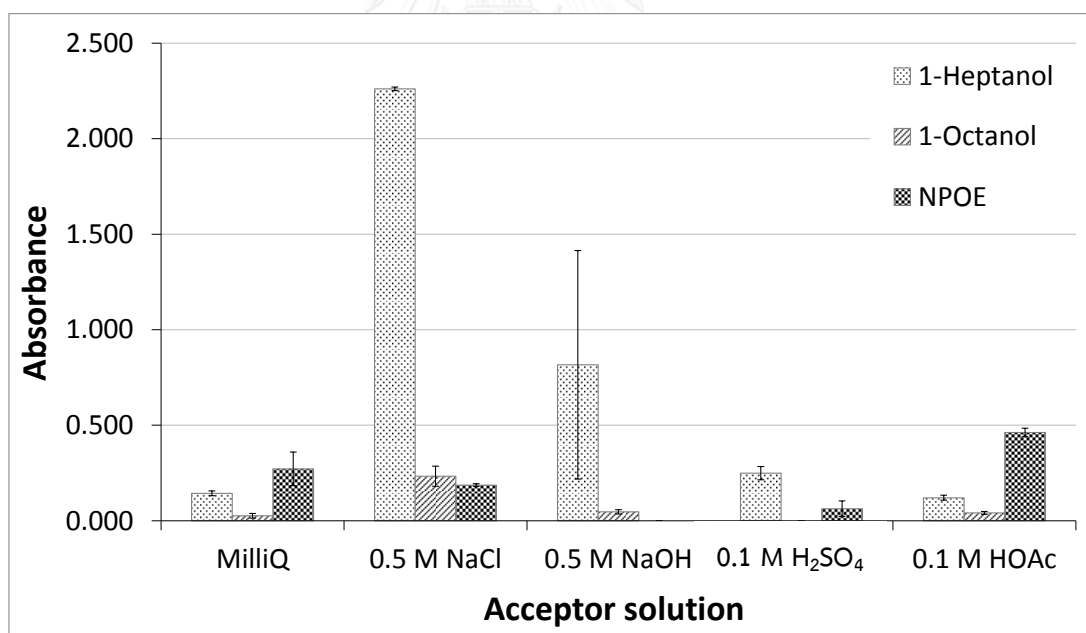

Figure 4.1 Extraction performance of Cr(VI) from MilliQ water using acceptors with different types of SLM; Cr(VI) 50 $\mu\text{g}\cdot\text{L}^{-1}$; extraction time: 5 min; applied potential: 50 V; stirring speed: 500 rpm; n = 3

4.2 Effect of ionic contents in the samples or sample conductivities on electromembrane extraction of Cr(VI)

Cr(VI) in samples with various concentrations of NaCl (various conductivity levels) were extracted and studied. The effect of ionic contents in the samples (sample conductivities) on the extraction performance of Cr(VI) was shown in various extraction profiles (Figure 4.2) using different types of SLM (1-heptanol, 1-octanol, and NPOE) and varied applied voltages and extraction times. In addition, 5% aliquot 336 in 1-heptanol, which was used as SLM for extraction of Cr(VI) from MilliQ water in the previous work [30] was also studied for comparison.

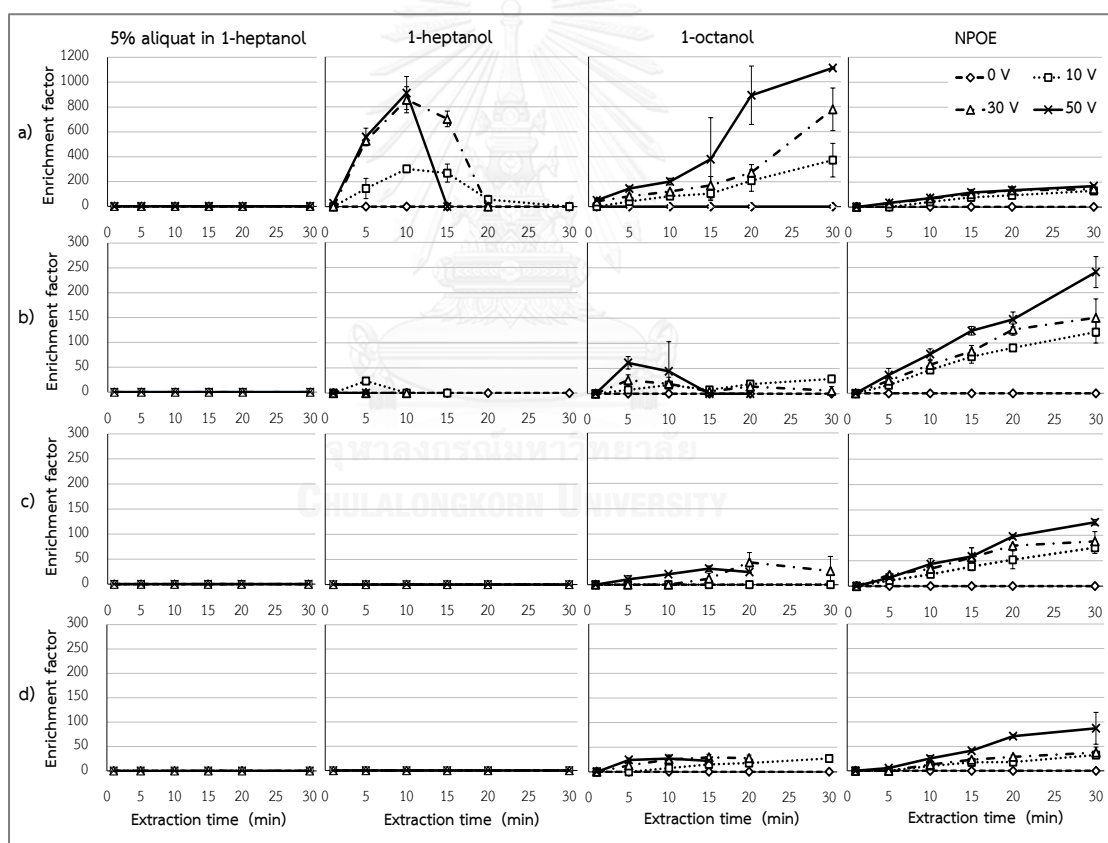

Figure 4.2 Extraction profiles of Cr(VI) from samples with various levels of ionic contents shown as conductivities: a) milliQ water ($1 \mu\text{S}\cdot\text{cm}^{-1}$); b) 1.0 mM NaCl (low level, $120 \mu\text{S}\cdot\text{cm}^{-1}$); c) 2.5 mM NaCl (moderate level, $310 \mu\text{S}\cdot\text{cm}^{-1}$); and d) 5.0 mM NaCl (high level, $630 \mu\text{S}\cdot\text{cm}^{-1}$); acceptor solution: 0.5 M NaCl; $n = 3$

The extraction profiles display that the ionic contents in the samples or sample conductivities obviously affected the EME efficiency. When using 5% aliquat 336 in 1-heptanol as SLM, no measureable results were observed for extraction of Cr(VI) from all samples with any level of conductivities even in milliQ water. The mixture of ionic carrier such as aliquat 336 in the SLM was expected to increase the transportation of ionic species across the liquid membranes. Therefore, bubbles could have formed or electrolysis could have occurred very rapidly resulting in loss of acceptor solution.

When the pure polar organic solvents (1-heptanol and 1-octanol) were employed as the SLM, Cr(VI) could be extracted. In case of 1-heptanol, high enrichment factor ($EF > 800$) was accomplished for extraction of Cr(VI) from milliQ water (no ionic content). The extraction performance was poor for extraction of Cr(VI) from samples with higher conductivity due to the bubble formation. In another case, 1-octanol has been reported as high effective organic liquid for EME of acidic drugs [8, 19] and metal ions [28, 29]. In our experiment, even though 1-octanol yielded lower enrichment factor for milliQ water than 1-heptanol at the same extraction time, 1-octanol could provide comparable enrichment factor at longer extraction time. Besides, 1-octanol was able to show some extraction capability of Cr(VI) in samples containing ionic contents despite it was not so good. The occurrence of electrolysis when using 1-octanol was slower than using 1-heptanol. Nevertheless, 1-octanol was still not good for EME of Cr(VI) from samples with high conductivity because of the occurrence of electrolysis.

NPOE has been reported as appropriate SLM for EME of ionizable basic drugs [6] but the extraction ability was poor for polar basic compounds [14] as well as metal ions [28]. From our results, NPOE was able to retrieve Cr(VI) from samples with all range of conductivity without occurrence of electrolysis at both electrodes. Considering that the SLM behaves like a capacitor or dielectric barrier [47] with a certain internal resistance, NPOE, which is the most viscous and has the highest dielectric constant among those three solvents (Table 4.1), could have the highest internal resistance. Therefore, NPOE could slow the transportation rate of charged species in the sample through the membrane and prolong the occurrence of

electrolysis in the EME system [28] leading to the more stable EME system. Moreover, NPOE is relatively high proton acceptor [21] so that it may facilitate the transportation of Cr(VI) oxyanions (i.e., HCrO_4^-), which contain proton across the liquid membrane. Hence, NPOE seemed to be the most suitable solvent for EME of Cr(VI) in samples with all range of conductivity.

Table 4.1 Properties of organic solvents employed for SLM

SLM	Viscosity (centipoise, cP)	Dielectric constant	Dipole moment
1-heptanol	5.97 ^A	12.10 ^B	1.71 ^B
1-octanol	7.59 ^A	10.30 ^B	1.68 ^B
NPOE	12.80 ^C	23.10 ^C	4.33 ^D
Aliquat 336	1450 ^E	-	-

Reference A [69] B [70] C [71] D [72] E [73]

From the Nernst-Planck flux equation (Equation 2.15) [51], the flux or mass transfer of charged analytes in EME was forced by an electric potential over the liquid membrane resulting in electrokinetic migration of the analytes from the donor solution to the acceptor solution. In our experiment, no Cr(VI) was observed in the acceptor solutions from samples with any conductivity levels with no application of voltage at any extraction times. Apparently, Cr(VI) was extracted when voltages were applied.

In case of 5% aliquat 336 in 1-heptanol, there was no Cr(VI) was found in the acceptor because of the bubble formation at both electrodes even only low voltage was applied, especially when extracted from samples with high conductivity. As discussed above, the ionic exchanger (aliquat 336) was anticipated to facilitate the transportation of ionic species across the liquid membrane causing the electrolysis occurred very easily.

In case of 1-heptanol, the enrichment factor dropped due to the bubble formation at the long extraction time. The phenomenon happened more quickly when higher voltages were applied and got worse in samples with high ionic contents (more conductive samples).

In case of 1-octanol, the extraction of Cr(VI) was well obtained but only extracted from milliQ water. Occurrence of electrolysis was observed when extracted from samples with high ionic contents and happened more quickly when higher voltages were applied as well as at longer extraction time. Nevertheless, the occurrence of electrolysis using 1-octanol was slower than using 1-heptanol as the SLM.

Finally, in case of NPOE, the enrichment factors of extracted Cr(VI) ion were improved with increased voltages and extraction times inspite they were not as high as those in 1-heptanol and 1-octanol. Most importantly, there was no bubble formation at any conditions for samples with any ionic contents (any conductivity levels). Figure 4.3 shows the closer look at the extraction profile of Cr(VI) using NPOE as the SLM from samples with conductivity range of 1-630 $\mu\text{S}\cdot\text{cm}^{-1}$. NPOE can be used as the SLM in EME system for extraction of Cr(VI) from ionic samples at applied voltage up to 50 V and extraction time up to 30 min. Figure 4.4 shows the current profile in EME system for extraction of Cr(VI) from ionic samples using NPOE as the SLM at 50 V. The current flow observed in the EME system was very low ($< 1 \mu\text{A}$) and stable resulting in improved system stability and good repeatability. Even though NPOE could extract the Cr(VI) from ionic samples, high applied voltage and long extraction time may be required for desire enrichment factor. It suggested that NPOE was a suitable SLM for EME of Cr(VI) that could be applied to ionic samples without occurrence of electrolysis. In order to achieve the most effective EME method for extraction of Cr(VI) from ionic samples, EME conditions were optimized.

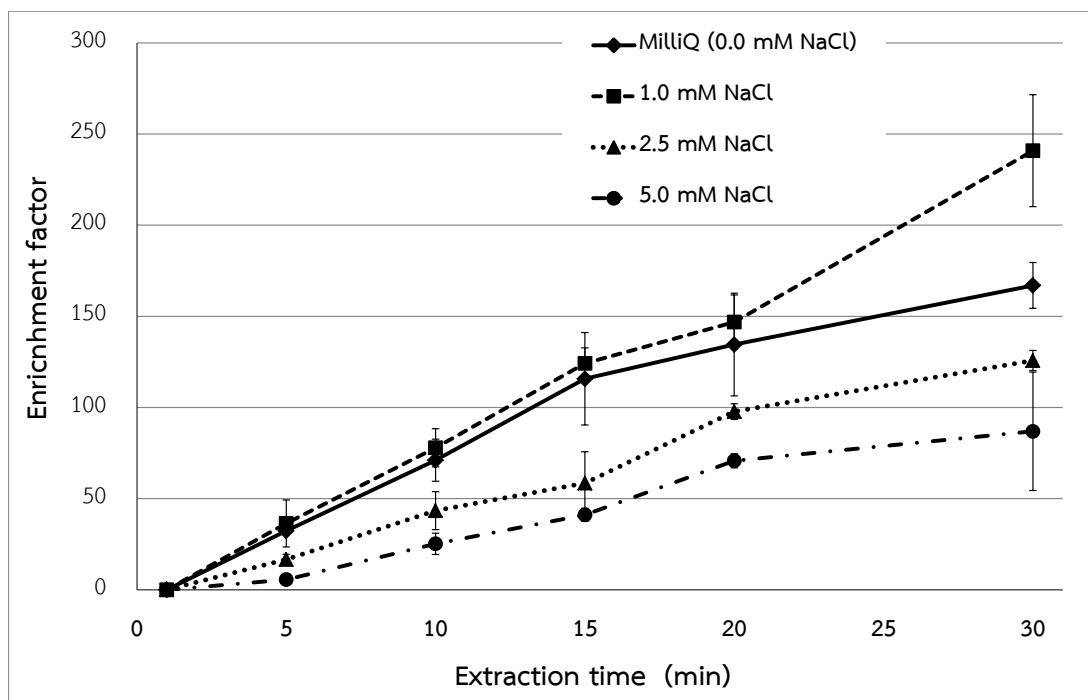

Figure 4.3 Extraction profile of Cr(VI) from samples with various conductivities using NPOE as the SLM; Cr(VI) $20 \mu\text{g}\cdot\text{L}^{-1}$; SLM: NPOE; acceptor solution: 0.5 M NaCl; applied voltage: 50 V; stirring speed: 500 rpm; n = 3

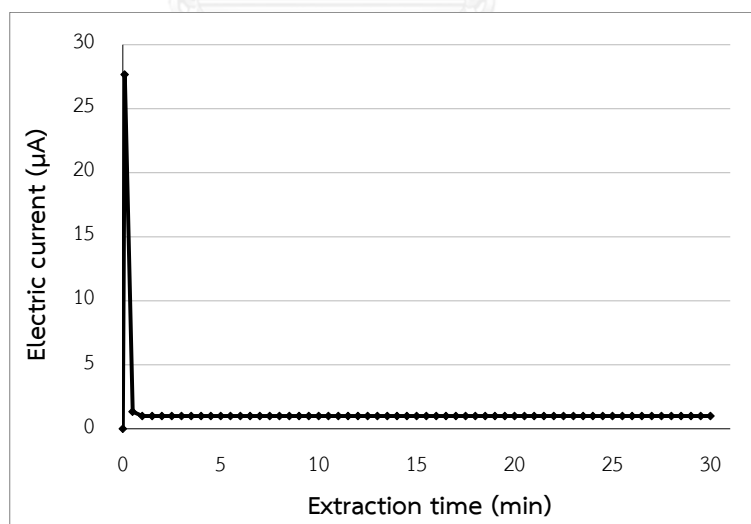

Figure 4.4 Current profile in EME system for extraction of Cr(VI) from ionic samples using NPOE as the SLM; Cr(VI) $20 \mu\text{g}\cdot\text{L}^{-1}$ in 5.0 mM NaCl; SLM: NPOE; acceptor solution: 0.5 M NaCl; applied voltage: 50 V; stirring speed: 500 rpm; n = 3

4.3 Optimization of electromembrane extraction of Cr(VI) from samples with high conductivity

Important parameters in EME method were thoroughly studied to define optimal condition for extraction of Cr(VI) from samples with high conductivity. In our experiments, type of organic solvent, sample pH, acceptor type, applied voltage and extraction time were optimized. The enrichment factor (EF) was utilized to evaluate the experimental results from each parameter optimization.

4.3.1 Type of SLM

In this EME system, the organic solvent immobilized in membrane pores behaves like a capacitor or dielectric in an electronic circuit. It is expected to control the migration of ionic species from donor sample to acceptor solution, especially from sample containing ionic components, and control the current flow in the EME system. From the section 4.2, NPOE was described as the most proper solvent for controlling the current flow ($< 2 \mu\text{A}$) leading to delaying the occurrence of electrolysis or bubble formation at both electrodes. However, pure NPOE provided poor extraction efficiency at low applied voltage and short extraction time. The mixture of some organic solvents and ionic exchangers into NPOE was expected to improve the extraction capability of the EME system.

NPOE was mixed with 1-heptanol and 1-octanol as the ratio of 90 : 10. Mixing NPOE with ionic exchangers such as aliquat 336 and DEHP at 5% was studied. The results shown in Figure 4.5 suggest that pure NPOE is still the best SLM for extraction of Cr(VI) from ionic samples. NPOE could well control the occurrence of electrolysis and provide satisfactory enrichment factor. When NPOE was mixed with 1-heptanol and 1-octanol, even though the bubble formation was not observed, the enrichment factors were very low or non-detectable. The reason might be that 1-heptanol and 1-octanol are relatively proton donor solvents while NPOE is high proton acceptor solvent [21]; therefore, when they were mixed, the effect of proton acceptor of NPOE to transportation of Cr(VI) across the SLM could be reduced, consequently.

When NPOE was mixed with ionic carriers, the electrolysis occurred since the beginning. The presence of ionic carrier in the SLM will facilitate the mass transport of analyte and ionic species from the samples through the membrane. The increase of current flow was observed that leads to decrease the internal resistance in SLM. Thus, the electrolysis or bubbles occurred easily and rapidly and Joule heating may be generated. Therefore, NPOE was selected as the SLM for this method.

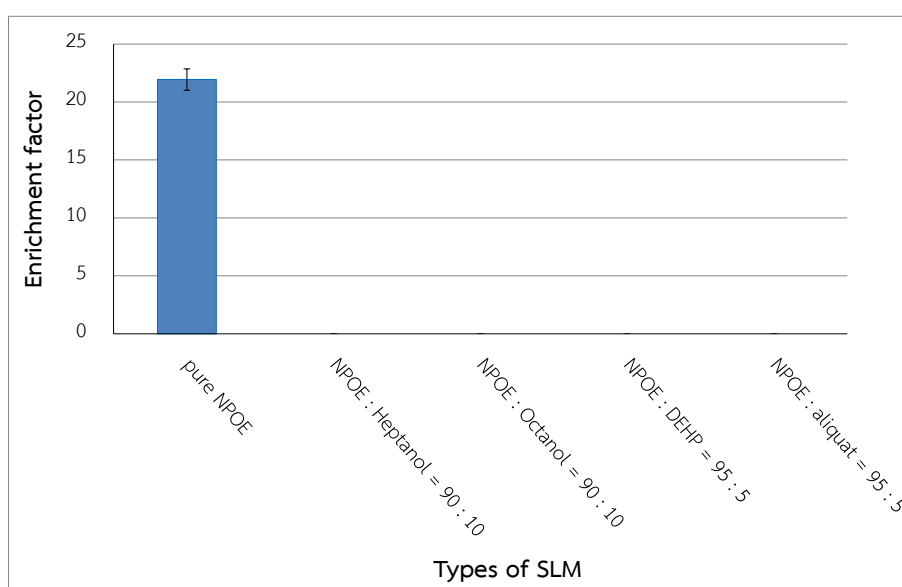

Figure 4.5 Type of SLM on EME efficiency of Cr(VI) from ionic samples; Cr(VI) $20 \mu\text{g}\cdot\text{L}^{-1}$ in 5.0 mM NaCl; acceptor solution: 0.5 M NaCl; extraction time: 15 min; applied voltage: 50 V; stirring speed: 500 rpm; $n = 3$

4.3.2 Sample pH

Since the pH of the solution affects the distribution of Cr(VI) species in the solution as shown in Figure 2.15, the effect of sample pH on extraction of Cr(VI) from ionic samples was studied and optimized. The pH of the donor solution (5.0 mM NaCl) was about 6. For the comparison of extraction efficiency, the sample solutions were adjusted to pH 4 with HCl and acetate buffer, pH 7 with NaOH and phosphate buffer and pH 10 with NaOH and borate buffer. The results are shown in Figure 4.6. Extraction of Cr(VI) was observed only from samples with acidic condition.

In acidic condition (pH 4), Cr(VI) mainly exists in the form of HCrO_4^- , which can mobile into the acceptor with charge of -1. However, acetate buffer solution was selected because the use of acetate buffer provided higher enrichment factor and smaller variation than HCl solution and normal donor solution (no pH adjustment).

In case of neutral donor (pH 7), the Cr(VI) co-exists in two forms of HCrO_4^- and CrO_4^{2-} or Cr(VI) is not completely in either HCrO_4^- or CrO_4^{2-} because the pH of the donor solution was about pK_a of HCrO_4^- as seen in Equation 4.1 [74]. Since the acidity of the sample solution was declined and the form and ratio between the two forms in the solution could not be certainly predicted, the extraction ability was poorer than using the acidic sample solution.

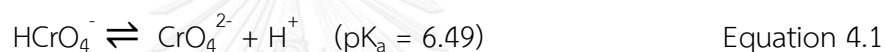

In case of basic pH of 10, the equilibrium will drive forward. Hence, HCrO_4^- was entirely converted to CrO_4^{2-} , which increases the capability of the moving forward into the acceptor under an electric field. CrO_4^{2-} has high negative charge of -2 leading to high mobility across the SLM. On the other hand, when the basic donor was used, the collected acceptor after extraction process was changed to pale yellow color while this phenomenon was not observed when using acidic and neutral sample. Because NPOE is yellow color solvent, it was assumed that NPOE might be dissolved into the basic donor solution during the extraction. It is a cause of punctuation of the SLM, system instability, and indefinable results. Therefore, the basic sample solution was not proper for extraction of Cr(VI) in this EME system.

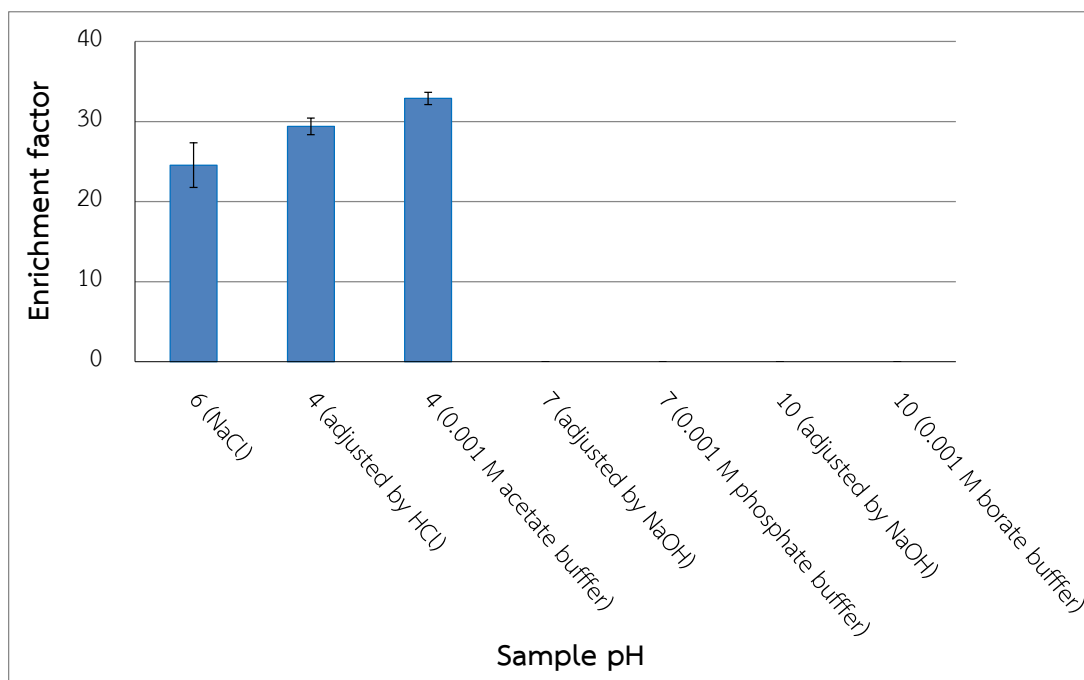

Figure 4.6 Effect of sample pH on extraction of Cr(VI) from ionic samples; Cr(VI) $20 \mu\text{g}\cdot\text{L}^{-1}$ in 5.0 mM NaCl ; SLM: NPOE; acceptor solution: 0.5 M NaCl ; extraction time: 15 min; applied voltage: 50 V; stirring speed: 500 rpm; $n = 3$

In addition, the concentrations of acetate buffer were varied in order to obtain the highest extractability of Cr(VI) from high electrical conductivity sample. The concentration ranges from 0.0001 M to 0.1 M of acetate buffer were studied. The results in Figure 4.7 show that the enrichment factor was slightly improved by raising the concentration of acetate buffer and reached to the maximum at 0.1 M . Hence, the sample or donor solution having 0.1 M acetate buffer was employed.

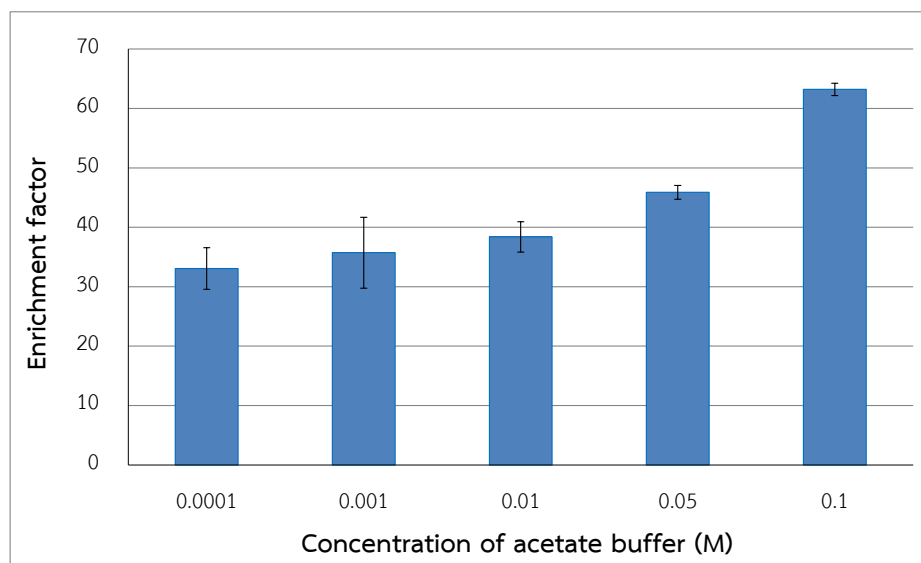

Figure 4.7 Extraction of Cr(VI) from ionic samples at various acetate buffer concentration; Cr(VI) $20 \mu\text{g}\cdot\text{L}^{-1}$ in 5.0 mM NaCl; SLM: NPOE; acceptor solution: 0.5 M NaCl; extraction time: 15 min; applied voltage: 50 V; stirring speed: 500 rpm; $n = 3$

4.3.3 Type of acceptor

The acceptors used in this experiment were divided into acid (H_2SO_4 , HOAc, and HCl), neutral (MilliQ and NaCl), and base (NaOH and NH_3). These solutions were investigated at the same concentration of 0.1 M. The results are shown in Figure 4.8. The extraction of Cr(VI) could be observed using neutral acceptor and acidic acceptors. Acetic acid showed the best performance for extraction of Cr(VI). One reason is probably due to weak acid property of HOAc while H_2SO_4 and HCl are strong acid. Strong acids such as HCl and H_2SO_4 are completely ionized, resulting in relatively high ionic species in the acceptor solution. Since the positively charged species; i.e., proton (H^+) in the acceptor tend to move towards the negative electrode in the donor solution; therefore, high amounts of protons may have formed a layer at the SLM/acceptor interface and prevent the transportation of HCrO_4^- into the acceptor. Another reason is that the large amounts of protons in the acceptor might have lowered the effect of proton acceptor of NPOE to transportation of Cr(VI) across the SLM because they provide lots of protons from the

acceptor solution to NPOE. This effect is less critical when using weak acid such as HOAc.

Moreover, milliQ and NaCl can provide better enrichment factors than strong acids and comparable enrichment factors with HOAc. Even though NaCl is completely ionized, NaCl does not contain proton (H^+) that would not affect the transportation of Cr(VI) across the SLM.

For the basic acceptor, the acceptor solution was obviously changed to yellow color; even the voltage was not applied. It can be explained as mentioned above that NPOE could be dissolved in the basic solution during the extraction process, so the EME system was unstable and the Cr(VI) could not be extracted using NaOH and NH_3 as the acceptor. Hence, HOAc was chosen as the acceptor solution in this work.

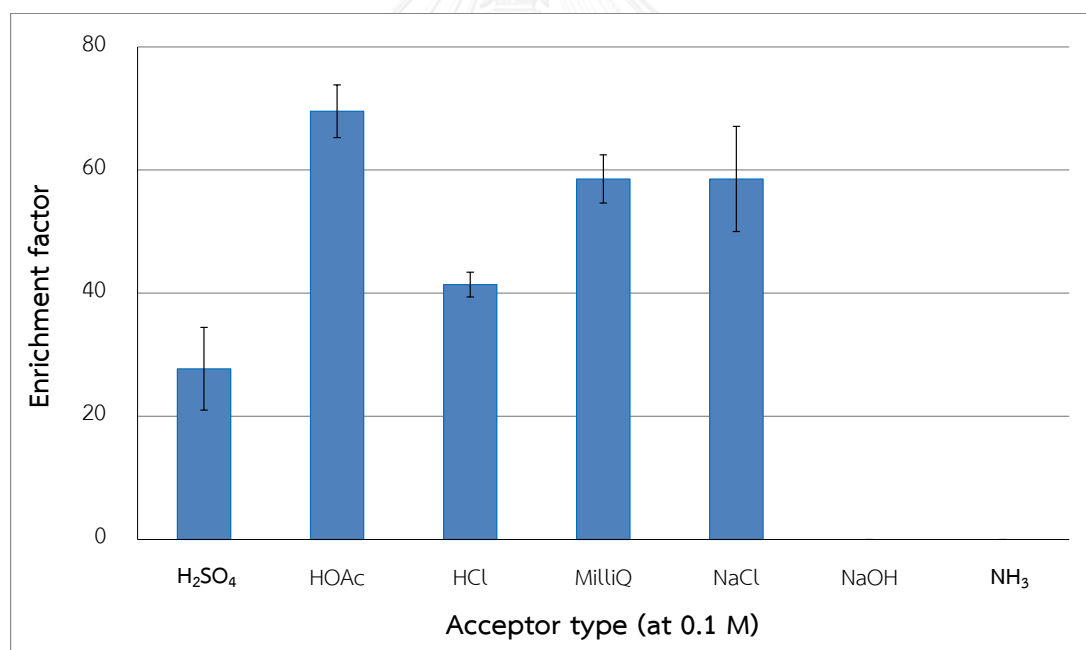

Figure 4.8 Extraction of Cr(VI) from ionic samples at various acceptors; Cr(VI) $20 \mu\text{g}\cdot\text{L}^{-1}$ in 5.0 mM NaCl, 0.1 M acetate buffer; SLM: NPOE; extraction time: 15 min; applied voltage: 50 V; stirring speed: 500 rpm; $n = 3$

Concentration of HOAc was studied at 0.05, 0.1, and 0.5 M. The results are shown in Figure 4.9. The enrichments of Cr(VI) obtained were not significantly

different among the three concentrations. According to the Nernst-Planck flux equation, the total concentration of ions in acceptor should be larger than that in donor or the ion balance should be low in order to improve flux of Cr(VI) across the SLM. Additionally, high concentration of ions in acceptor solution will complete the electric circuit easily. The concentration of 0.5 M is higher than the total ionic concentration in the sample solution so that it would provide higher enrichment factor than the others. So, 0.5 M HOAc was used as the acceptor for extraction of Cr(VI).

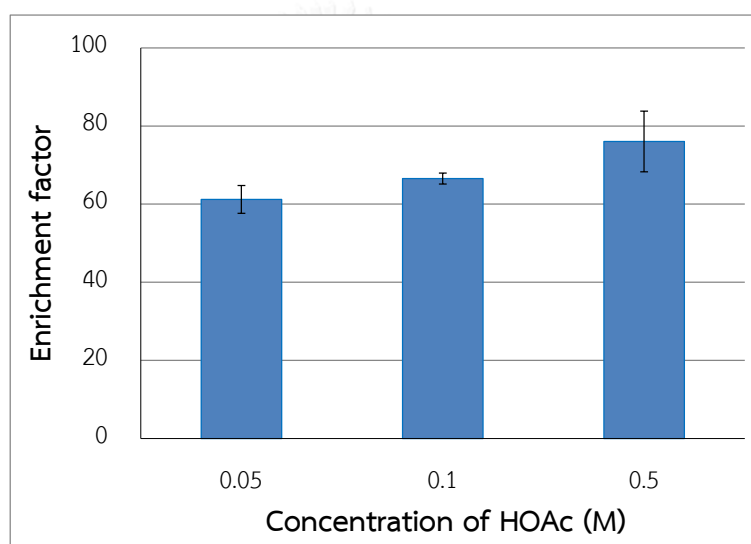

Figure 4.9 Extraction of Cr(VI) from ionic samples at various concentrations of HOAc; Cr(VI) $20 \mu\text{g}\cdot\text{L}^{-1}$ in 5.0 mM NaCl, 0.1 M acetate buffer; SLM: NPOE; extraction time: 15 min; applied voltage: 50 V; stirring speed: 500 rpm; n = 3

4.3.4 Applied voltage

The applied voltage plays an important role to promote the mass transfer of analyte in EME system with electrokinetic migration mechanism. According to Nernst-Planck flux equation; the transportation ability of the analyte across the SLM is enhanced with increased electric field over the SLM. In this work, the applied voltages were investigated from 0 to 100 V. The results are shown in Figure 4.10.

Apparently, with no application of an electric field, there was no Cr(VI) could be extracted at all. Cr(VI) ion cannot transport across the organic liquid via only passive diffusion mechanism. However, the extraction of Cr(VI) was orderly improved with increasing the voltage and got to the maximum at 100 V without bubble formation or occurrence of electrolysis. Thus, the voltage of 100 V could be used in the EME system for extraction of Cr(VI) from ionic samples.

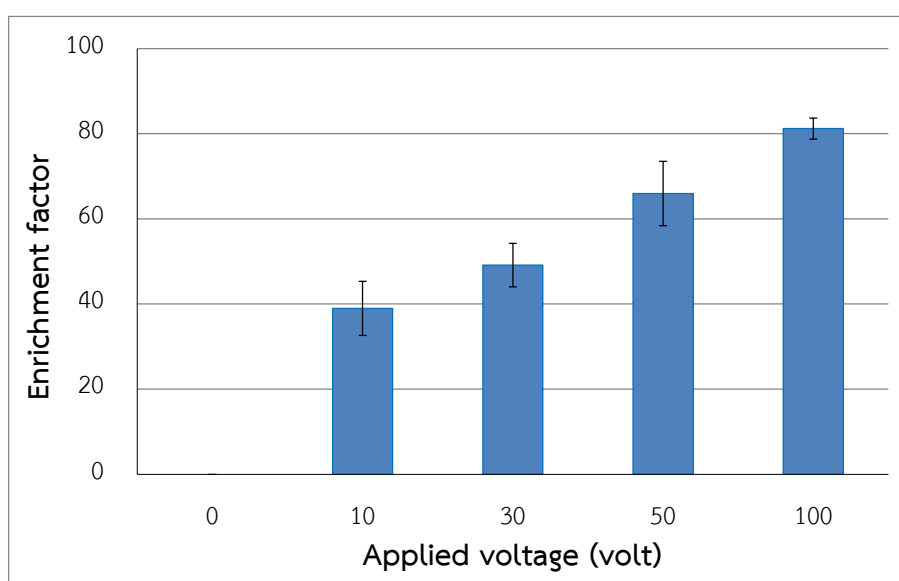

Figure 4.10 Extraction of Cr(VI) from ionic samples at various applied voltages; Cr(VI) $20 \mu\text{g}\cdot\text{L}^{-1}$ in 5.0 mM NaCl, 0.1 M acetate buffer; SLM: NPOE; acceptor solution: 0.5 M HOAc; extraction time: 15 min; stirring speed: 500 rpm; $n = 3$

4.3.5 Extraction time

EME is a non-exhaustive extraction technique. Extraction time profile is typically established for optimum extraction performance. Extraction times of 5, 10, 15, 20, 25 and 30 minutes were studied and the results are showed in Figure 4.11. The extraction was not observed at 5 min since it was too short to drive the Cr(VI) across the membrane. The enrichment improved when the extraction time was extended. The obtained result was the highest at 30 min. However, practically, long extraction times are not favorable. The extraction time of 15 min provides sufficient enrichment

factor for detection by Cr-DPC colorimetric method and was selected for this extraction process.

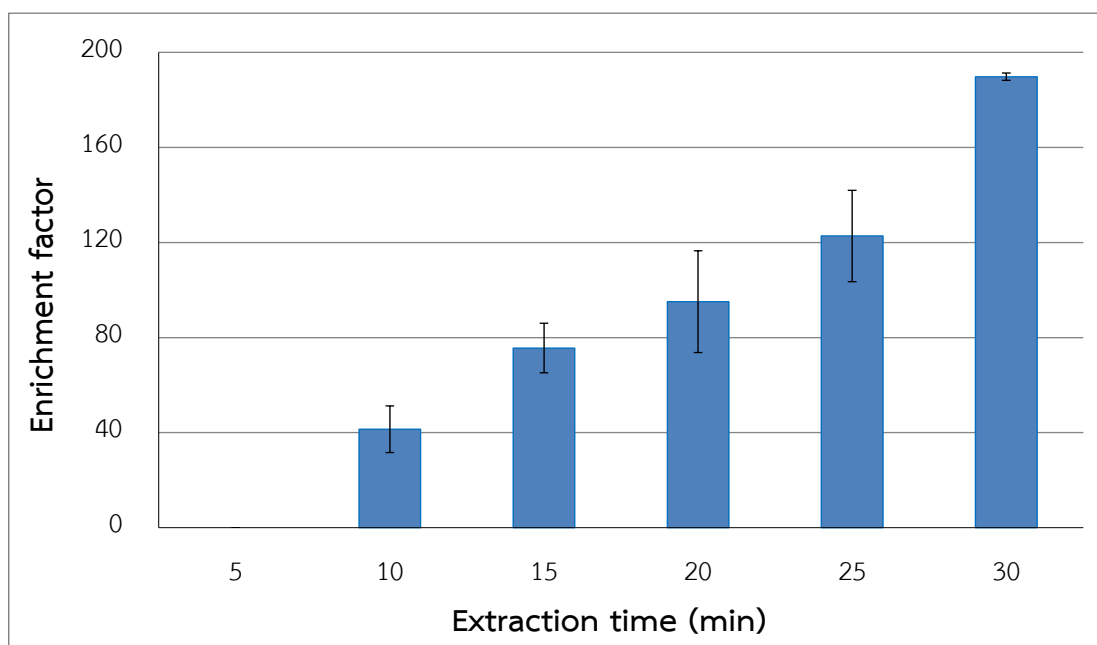

Figure 4.11 Extraction time profile of Cr(VI) from ionic samples; Cr(VI) $20 \mu\text{g}\cdot\text{L}^{-1}$ in 5.0 mM NaCl, 0.1 M acetate buffer; SLM: NPOE; acceptor solution: 0.5 M HOAc; applied voltage: 100 V; stirring speed: 500 rpm; n = 3

The conditions of EME method for determination of Cr(VI) in high ionic samples are summarized in Table 4.2.

Table 4.2 Conditions of EME for determination of Cr(VI) in ionic samples

EME parameters	Optimum condition
Hollow fiber length	5 cm
Organic solvent	NPOE
Donor solution	0.1 M acetate buffer, pH 4
Donor volume	28 mL
Acceptor solution	0.5 M HOAc
Acceptor volume	13 μ L
Applied voltage	100 V
Extraction time	15 min
Stirring speed	500 rpm

4.4 Method evaluation

The EME method for determination of Cr(VI) was evaluated for its analytical merits using samples with high conductivity (Cr(VI) in 5.0 mM NaCl, 630 μ S \cdot cm⁻¹) and real sample matrices.

4.4.1 Calibration curve and linearity

The calibration curve of the method was established using standard Cr(VI) at various concentrations in the working range of 10.0-80.0 μ g \cdot L⁻¹ containing 5.0 mM NaCl. The working range covers the maximum contaminated level (MCL) of Cr(VI) in drinking water and tap water (50 μ g \cdot L⁻¹) recommended by WHO [59, 60]. The linear working range is plotted between absorbance values and spiked standard concentrations. As seen in Figure 4.12, a good linearity was observed over the working range with coefficient of determination (R^2) of 0.9996.

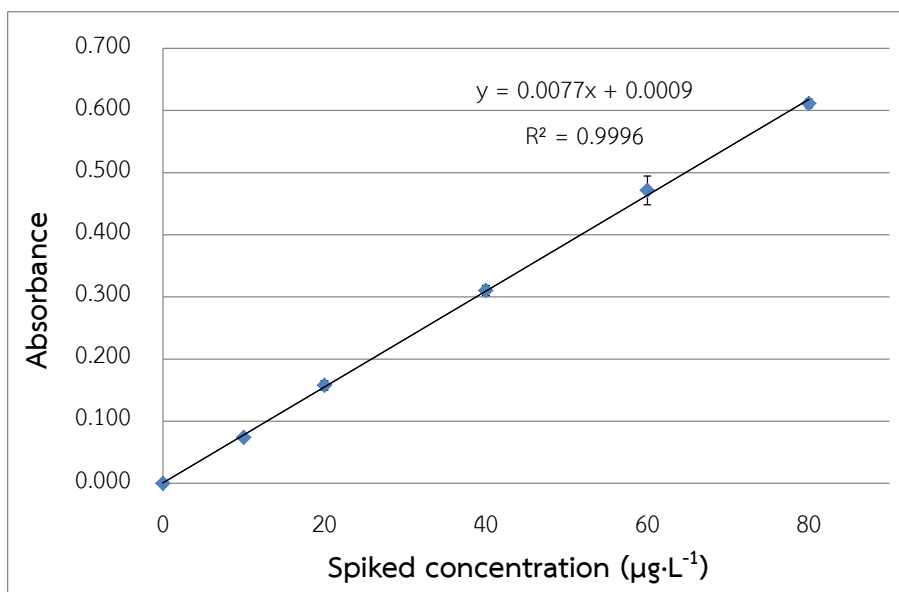

Figure 4.12 Calibration curve of EME method for determination of Cr(VI) from ionic water samples (0.5 M NaCl in MilliQ water)

4.4.2 Limit of detection (LOD) and limit of quantification (LOQ)

The LOD and LOQ of the method were calculated based on standard deviation of regression line (Equation 3.1 and 3.2, respectively). The method LOD and LOQ for determination of Cr(VI) from ionic water samples (0.5 M in MilliQ water) are reported in Table 4.3. The LOD and LOQ values are in low $\mu\text{g}\cdot\text{L}^{-1}$ level which are below the MCL of Cr(VI) in drinking water and tap water ($50 \mu\text{g}\cdot\text{L}^{-1}$) recommended by WHO, indicating that the method can be applied for determination of Cr(VI) in drinking waters and natural waters in $\text{ng}\cdot\text{L}^{-1}$ to $\mu\text{g}\cdot\text{L}^{-1}$ level.

4.4.3 Enrichment factor

The enrichment factor of the EME method was calculated from the ratio of final concentration of Cr(VI) in the acceptor to the spiked concentration of Cr(VI) in the sample. In this experiment, Cr(VI) was spiked in sample at $20 \mu\text{g}\cdot\text{L}^{-1}$ and $50 \mu\text{g}\cdot\text{L}^{-1}$. After extraction, the enrichment factor about 80 at two spiking levels was accomplished as written in Table 4.3.

4.4.4 Accuracy

The method accuracy was evaluated using recovery study of spiked Cr(VI) in water samples. The observed concentration derived from the regression equation from the matrix-match standard calibration curve. The recoveries were studied at $20 \mu\text{g}\cdot\text{L}^{-1}$ and $50 \mu\text{g}\cdot\text{L}^{-1}$ with 3 replicates. The results are summarized in Table 4.3.

4.4.5 Precision

The method repeatability and reproducibility were evaluated from relative standard deviations (%R.S.D.) of enrichment factor determined within a day (intra-day precision) and determined for several days (inter-day precision), respectively. In this work, precision was evaluated at $20 \mu\text{g}\cdot\text{L}^{-1}$ spiked level of Cr(VI) under optimized EME conditions. The intra-day precision was estimated in one day with eight replicates while the inter-day precision was determined from the results within five consecutive days in three replicates per day. The results are reported in Table 4.3. The intra-day precision of this method was 3.1% and inter-day precision (n=5) was 7.1% which were acceptable according to AOAC guideline [67, 68]. It indicates that the developed method provides good precision.

Table 4.3 Analytical merits of EME of Cr(VI) in high electrical conductivity sample (5.0 mM NaCl)

Linear equation		$y = 0.0077x + 0.0009$
R ²		0.9996
Linearity		10.0 – 80.0 $\mu\text{g}\cdot\text{L}^{-1}$
%Recovery \pm SD (n=3)	at 20 $\mu\text{g}\cdot\text{L}^{-1}$	98 \pm 1.0
	at 50 $\mu\text{g}\cdot\text{L}^{-1}$	108 \pm 2.3
Intra-day precision (n=8)	Average EF \pm SD	79 \pm 2.5
	%R.S.D.	3.1
Inter-day precision (n=5)	Average EF \pm SD	81 \pm 5.7
	%R.S.D.	7.1
LOD ($\mu\text{g}\cdot\text{L}^{-1}$)		2.1
LOQ ($\mu\text{g}\cdot\text{L}^{-1}$)		7.2

4.4.6 Matrix effect

The method was evaluated for matrix effect by comparison of the extraction performance of spiked Cr(VI) (20 $\mu\text{g}\cdot\text{L}^{-1}$) from various kinds of real water samples such as drinking water, mineral water, tap water and surface water samples. Figure 4.13 illustrates the enrichment factors obtained from the various samples. The extraction performances differed from different matrices with different sample conductivities, assumed different levels of ionic contents. The method is matrix dependent. Therefore, methods of matrix-match calibration method and standard addition method are recommended for accurate results when applied to real water samples.

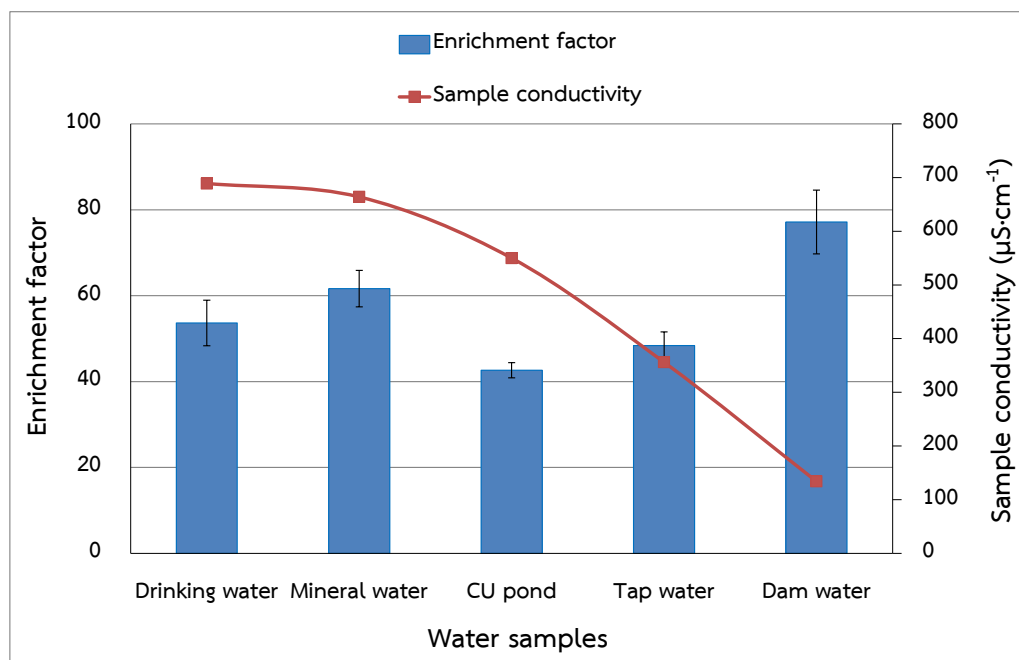

Figure 4.13 Extraction performance of spiked Cr(VI) from various kinds of real water samples; Cr(VI) $20 \mu\text{g}\cdot\text{L}^{-1}$ in samples, 0.1 M acetate buffer; SLM: NPOE; acceptor solution: 0.5 M HOAc; applied voltage: 100 V; extraction time: 15 min; stirring speed: 500 rpm; $n = 2$

4.5 Application of EME method for determination of Cr(VI) from real water samples

The method was applied for determination of Cr(VI) from various kinds of real water samples such as drinking water, mineral water, tap water and surface water samples (Kaeng Krachan Dam water and CU pond water) with various sample conductivities ($134\text{-}689 \mu\text{S}\cdot\text{cm}^{-1}$). There was no Cr(VI) was found in all water samples. The recovery of spiked Cr(VI) ($20 \mu\text{g}\cdot\text{L}^{-1}$ and $50 \mu\text{g}\cdot\text{L}^{-1}$) determined from the matrix-match standard method were in the range of 93-140% with %R.S.D. less than 12%. The results are summarized in Table 4.4.

Table 4.4 Analytical performance of EME of Cr(VI) in real water samples

Samples	EC ($\mu\text{S}\cdot\text{cm}^{-1}$)	Linearity ($\mu\text{g}\cdot\text{L}^{-1}$)	Linear equation	R^2	LOD ($\mu\text{g}\cdot\text{L}^{-1}$)	LOQ ($\mu\text{g}\cdot\text{L}^{-1}$)	Accuracy at					
							20 $\mu\text{g}\cdot\text{L}^{-1}$		50 $\mu\text{g}\cdot\text{L}^{-1}$			
							%Recovery	%R.S.D.	%Recovery	%R.S.D.		
Drinking water	689	15.0-80.0	$y = 0.0085x - 0.0069$	0.9975	5.8	17.4	92	4.1	115	8.3		
Mineral water	644	10.0-80.0	$y = 0.0087x - 0.0085$	0.9971	6.5	19.4	124	11.9	105	4.8		
CU pond	550	20.0-80.0	$y = 0.0062x - 0.0053$	0.9963	6.7	20.5	98	9.0	140	7.6		
Tap water	356	10.0-60.0	$y = 0.0066x + 0.0017$	0.9981	3.4	12.0	97	6.0	104	5.3		
Dam water	134	10.0-60.0	$y = 0.0105x - 0.0239$	0.9935	9.0	24.8	98	3.0	106	1.1		

Remark:

- %recoveries were based on matrix-match standard method

- EC = Electrical conductivity, which was directly measured by conductivity meter

- R^2 = Correlation coefficient

CHAPTER V

CONCLUSION

5.1 Conclusion

Electromembrane extraction (EME) is an extraction technique for isolation and preconcentration of charged analytes from samples via electrokinetic migration mechanism. The analytes transport across the liquid membrane under the application of an electric field over the SLM. In this work, EME has been studied and developed for extraction of a metal oxyanion focusing on controlling problems involving bubble formation and system instability when samples containing various amounts of ionic components were analyzed. Cr(VI) in the form of oxyanion was selected as the model. NPOE showed the most appropriate organic solvent for controlling and retarding the occurrence of electrolysis and bubble formation at both sides of electrode. This may be because NPOE has high viscosity and high dielectric constant properties, which control the migration of ionic species across the membrane. So, it could reduce the chance of electrolysis to be occurred. Since electric current flow in the system was very low when using NPOE as the SLM, the system stability was maintained while the system deviation was improved.

Furthermore, the significant parameters of EME were optimized for determination of Cr(VI) in ionic samples. The conditions for efficient extraction of Cr(VI) from ionic samples were that the sample was acidified using 0.1 M acetate buffer; the SLM was NPOE; the acceptor was 0.5 M acetic acid; and the EME system was operated at 100 V for 15 min. The acceptable preconcentration factor of approximately 80 was achieved under optimum conditions.

The method performance shows good linearity with the working range from 10.0 to 80.0 $\mu\text{g}\cdot\text{L}^{-1}$. The method limit of detection is lower than the maximum contaminated level (MCL) of Cr(VI) in waters recommended by WHO and EPA. Accuracy and precision are in the acceptable range according to the AOAC recommendation. The proposed method was applied for extraction of Cr(VI) in real

water samples with different amounts of ionic components. Since the matrix showed impact to the extraction capability of Cr(VI), matrix-match standard method and standard addition method are recommended for application to real water samples. This study provides the guideline in development of EME for ionic analytes from ionic samples showing as various electrical conductivities; for example, mineral waters, some drinking waters, tap waters, and natural waters.

5.2 Suggestion for future study

This work focused on studying the impact of ionic contents (measured as conductivities) in water samples using NaCl as the representative of ionic matrix. However, extraction efficiency in some samples may be influenced by other ionic species or dissolved organic contents. Hence, the EME system may be studied using sample containing other ions or using more variety of organic solvent. This method is probably developed and applied for EME of other metal oxyanions in various aqueous samples.

REFERENCES

- [1] USEPA. Test methods for evaluating solid waste: physical/chemical methods. 3rd ed. Washington, DC, USA: US GPO, 1986.
- [2] Dadfarnia, S. and Haji Shabani, A.M. Recent development in liquid phase microextraction for determination of trace level concentration of metals--a review. Analytica Chimica Acta 658(2) (2010): 107-119.
- [3] Psillakis, E. and Kalogerakis, N. Developments in liquid-phase microextraction. TrAC Trends in Analytical Chemistry 22(10) (2003): 565-574.
- [4] Liu, H. and Dasgupta, P.K. Analytical Chemistry in a drop. Solvent extraction in a microdrop. Analytical Chemistry 68(11) (1996): 1817-1821.
- [5] Pedersen-Bjergaard, S. and Rasmussen, K.E. Liquid-liquid-liquid microextraction for sample preparation of biological fluids prior to Capillary Electrophoresis. Analytical Chemistry 71(14) (1999): 2650-2656.
- [6] Pedersen-Bjergaard, S. and Rasmussen, K.E. Electrokinetic migration across artificial liquid membranes. New concept for rapid sample preparation of biological fluids. Journal of Chromatography A 1109(2) (2006): 183-190.
- [7] Arjomandi-Behzad, L., Yamini, Y., and Rezazadeh, M. Pulsed electromembrane method for simultaneous extraction of drugs with different properties. Analytical Biochemistry 438(2) (2013): 136-143.
- [8] Balchen, M., Gjelstad, A., Rasmussen, K.E., and Pedersen-Bjergaard, S. Electrokinetic migration of acidic drugs across a supported liquid membrane. Journal of Chromatography A 1152(1-2) (2007): 220-225.
- [9] Basheer, C., Lee, J., Pedersen-Bjergaard, S., Rasmussen, K.E., and Lee, H.K. Simultaneous extraction of acidic and basic drugs at neutral sample pH: a novel electro-mediated microextraction approach. Journal of Chromatography A 1217(43) (2010): 6661-6667.
- [10] Dominguez, N.C., et al. Selective electromembrane extraction at low voltages based on analyte polarity and charge. Journal of Chromatography A 1248 (2012): 48-54.

- [11] Eibak, L.E., Gjelstad, A., Rasmussen, K.E., and Pedersen-Bjergaard, S. Exhaustive electromembrane extraction of some basic drugs from human plasma followed by liquid chromatography-mass spectrometry. Journal of Pharmaceutical and Biomedical Analysis 57 (2012): 33-38.
- [12] Eibak, L.E., Rasmussen, K.E., Oiestad, E.L., Pedersen-Bjergaard, S., and Gjelstad, A. Parallel electromembrane extraction in the 96-well format. Analytica Chimica Acta 828 (2014): 46-52.
- [13] Gjelstad, A., Jensen, H., Rasmussen, K.E., and Pedersen-Bjergaard, S. Kinetic aspects of hollow fiber liquid-phase microextraction and electromembrane extraction. Analytica Chimica Acta 742 (2012): 10-16.
- [14] Gjelstad, A., Rasmussen, K.E., and Pedersen-Bjergaard, S. Electrokinetic migration across artificial liquid membranes tuning the membrane chemistry to different types of drug substances. Journal of Chromatography A 1124(1-2) (2006): 29-34.
- [15] Kjelsen, I.J., Gjelstad, A., Rasmussen, K.E., and Pedersen-Bjergaard, S. Low-voltage electromembrane extraction of basic drugs from biological samples. Journal of Chromatography A 1180(1-2) (2008): 1-9.
- [16] Kuban, P. and Bocek, P. Micro-electromembrane extraction across free liquid membranes. Extractions of basic drugs from undiluted biological samples. Journal of Chromatography A 1337 (2014): 32-39.
- [17] Kuban, P. and Bocek, P. Micro-electromembrane extraction across free liquid membranes. Instrumentation and basic principles. Journal of Chromatography A 1346 (2014): 25-33.
- [18] Middelthon-Bruer, T.M., Gjelstad, A., Rasmussen, K.E., and Pedersen-Bjergaard, S. Parameters affecting electro membrane extraction of basic drugs. Journal of Separation Science 31(4) (2008): 753-759.
- [19] Rezazadeh, M., Yamini, Y., Seidi, S., and Arjomandi-Behzad, L. Voltage-step pulsed electromembrane as a novel view of electrical field-induced liquid-phase microextraction. Journal of Chromatography A 1324 (2014): 21-28.
- [20] Seidi, S., Yamini, Y., Rezazadeh, M., and Esrafil, A. Low-voltage electrically-enhanced microextraction as a novel technique for simultaneous extraction

- of acidic and basic drugs from biological fluids. Journal of Chromatography A 1243 (2012): 6-13.
- [21] Seip, K.F., Faizi, M., Vergel, C., Gjelstad, A., and Pedersen-Bjergaard, S. Stability and efficiency of supported liquid membranes in electromembrane extraction-a link to solvent properties. Analytical and Bioanalytical Chemistry 406(8) (2014): 2151-2161.
- [22] Seip, K.F., Jensen, H., Kieu, T.E., Gjelstad, A., and Pedersen-Bjergaard, S. Salt effects in electromembrane extraction. Journal of Chromatography A 1347 (2014): 1-7.
- [23] Balchen, M., Lund, H., Reubsaet, L., and Pedersen-Bjergaard, S. Fast, selective, and sensitive analysis of low-abundance peptides in human plasma by electromembrane extraction. Analytica Chimica Acta 716 (2012): 16-23.
- [24] Balchen, M., Reubsaet, L., and Pedersen-Bjergaard, S. Electromembrane extraction of peptides. Journal of Chromatography A 1194(2) (2008): 143-149.
- [25] Seip, K.F., Stigsson, J., Gjelstad, A., Balchen, M., and Pedersen-Bjergaard, S. Electromembrane extraction of peptides-fundamental studies on the supported liquid membrane. Journal of Separation Science 34(23) (2011): 3410-3417.
- [26] Basheer, C., Tan, S.H., and Lee, H.K. Extraction of lead ions by electromembrane isolation. Journal of Chromatography A 1213(1) (2008): 14-18.
- [27] Davarani, S.S., Moazami, H.R., Keshtkar, A.R., Banitaba, M.H., and Nojavan, S. A selective electromembrane extraction of uranium(VI) prior to its fluorometric determination in water. Analytica Chimica Acta 783 (2013): 74-79.
- [28] Kuban, P., Strieglerova, L., Gebauer, P., and Bocek, P. Electromembrane extraction of heavy metal cations followed by capillary electrophoresis with capacitively coupled contactless conductivity detection. Electrophoresis 32(9) (2011): 1025-1032.
- [29] Safari, M., Nojavan, S., Davarani, S.S., and Morteza-Najarian, A. Speciation of chromium in environmental samples by dual electromembrane extraction

- system followed by high performance liquid chromatography. Analytica Chimica Acta 789 (2013): 58-64.
- [30] Chanthasakda, N. Electrical field assisted liquid phase microextraction for determination of chromate ion. M.Sc. Thesis, Department of Chemistry, Chulalongkorn University, 2013.
- [31] Sigma-Aldrich. Product information: sodium chloride 1972. Available from: https://www.sigmaaldrich.com/content/dam/sigma-aldrich/docs/Sigma-Aldrich/Product_Information_Sheet/s7653pis.pdf [Nov 8, 2014]
- [32] Sigma-Aldrich. Bis(2-ethylhexyl) phosphate Available from: <http://www.sigmaaldrich.com/catalog/product/aldrich/237825?lang=en®ion=TH> [November 9, 2014]
- [33] Sigma-Aldrich. 2-nitrophenyl octyl ether (NPOE) Available from: <http://www.sigmaaldrich.com/catalog/product/aldrich/365130?lang=en®ion=TH> [November 9, 2014]
- [34] Rezazadeh, M., Yamini, Y., Seidi, S., and Esrafil, A. Pulsed electromembrane extraction: a new concept of electrically enhanced extraction. Journal of Chromatography A 1262 (2012): 214-218.
- [35] Rezazadeh, M., Yamini, Y., Seidi, S., and Esrafil, A. One-way and two-way pulsed electromembrane extraction for trace analysis of amino acids in foods and biological samples. Analytica Chimica Acta 773 (2013): 52-59.
- [36] Huang, C., et al. Development of a flat membrane based device for electromembrane extraction: a new approach for exhaustive extraction of basic drugs from human plasma. Journal of Chromatography A 1326 (2014): 7-12.
- [37] Mitra, S. and Brukh, R. Sample preparation techniques in Analytical Chemistry. J. D. Winefordner ed. Vol. 162. New Jersey, US: John Wiley & Sons, Inc., 2003.
- [38] Ho, T.S., Pedersen-Bjergaard, S., and Rasmussen, K.E. Recovery, enrichment and selectivity in liquid-phase microextraction comparison with conventional liquid-liquid extraction. Journal of Chromatography A 963 (2002): 3-17.
- [39] Sarafraz-Yazdi, A. and Amiri, A. Liquid-phase microextraction. TrAC Trends in Analytical Chemistry 29(1) (2010): 1-14.

- [40] Chang, Y. Membrane Applications 2006. Available from: <http://www.mnawwa.org/about/councils/training/research/Membrane%20Applications%20Presentation.ppt> [November 22, 2014]
- [41] Eibak, L.E.E. Development of electromembrane extraction configurations and applications. Ph.D., Department of Pharmaceutical Chemistry, University of Oslo, 2014.
- [42] Pedersen-Bjergaard, S. and Rasmussen, K.E. Liquid-phase microextraction with porous hollow fibers, a miniaturized and highly flexible format for liquid-liquid extraction. Journal of Chromatography A 1184(1-2) (2008): 132-142.
- [43] Yudthavorasit, S. and Leepipatpiboon, N. Hollow-fiber liquid-phase microextraction for determination of macrolide antibiotic residues in water and poultry muscle. M.Sc. Thesis, Department of Chemistry, Chulalongkorn University, 2009.
- [44] Ho, T.S., Halvorsen, T.G., Pedersen-Bjergaard, S., and Rasmussen, K.E. Liquid-phase microextraction of hydrophilic drugs by carrier-mediated transport. Journal of Chromatography A 998(1-2) (2003): 61-72.
- [45] Ghambarian, M., Yamini, Y., and Esrafil, A. Developments in hollow fiber based liquid-phase microextraction: principles and applications. Microchim Acta 177(3-4) (2012): 271-294.
- [46] Zhang, Z., Zhang, C., Su, X., Ma, M., Chen, B., and Yao, S. Carrier-mediated liquid phase microextraction coupled with high performance liquid chromatography for determination of illicit drugs in human urine. Analytica Chimica Acta 621(2) (2008): 185-192.
- [47] Moazami, H.R., Nojavan, S., Zahedi, P., and Davarani, S.S. Electronic simulation of the supported liquid membrane in electromembrane extraction systems: Improvement of the extraction by precise periodical reversing of the field polarity. Analytica Chimica Acta 841 (2014): 24-32.
- [48] Gjelstad, A. Electromembrane extraction: The use of electrical potential for isolation of charged substances from biological matrices. LC GC Eur 23(2010), 152.

- [49] Yamini, Y., Seidi, S., and Reza zadeh, M. Electrical field-induced extraction and separation techniques: promising trends in analytical chemistry-a review. Analytica Chimica Acta 814 (2014): 1-22.
- [50] Reza zadeh, M., Yamini, Y., and Seidi, S. Electromembrane extraction of trace amounts of naltrexone and nalmefene from untreated biological fluids. Journal of Chromatography B 879(15-16) (2011): 1143-1148.
- [51] Gjelstad, A., Rasmussen, K.E., and Pedersen-Bjergaard, S. Simulation of flux during electro-membrane extraction based on the Nernst-Planck equation. Journal of Chromatography A 1174(1-2) (2007): 104-111.
- [52] USEPA. Conductivity monitoring & assessment 2012. Available from: <http://water.epa.gov/type/rsl/monitoring/vms59.cfm> [December 7, 2014]
- [53] UNEP. Chapter 12: Electrical conductivity. in Training materials on monitoring transboundary air pollution, pp. 73-78. Bangkok, Thailand: UNEP/RRC.AP, 2004.
- [54] Down, R.D. and Lehr, J.H. Environmental instrumentation and analysis handbook. Hoboken, New Jersey.: John Wiley & Sons, Inc., 2004.
- [55] APHA. Standard methods for the examination of water and wastewater. Washington, DC: American Public Health Association, 1992.
- [56] Lenntech. Water conductivity Available from: <http://www.lenntech.com/applications/ultrapure/conductivity/water-conductivity.htm> [December 7, 2014]
- [57] Bockris, J.O.M., Reddy, A.K.N., and Gamboa-Aldeco, M.E. Modern Electrochemistry. New York, USA: Springer Science & Business Media, 1998.
- [58] USEPA. Ways to measure ionic strength 2012. Available from: http://www.epa.gov/caddis/ssr_ion_wtm.html [December 7, 2014]
- [59] WHO. Chromium in drinking-water. in 2nd (ed.) Guidelines for drinking-water quality, p. 8. Geneva: World Health Organization, 2003.
- [60] USEPA. EPA evaluation of chromium 6 in drinking water 2010. Available from: <http://www.epa.gov/ttn/atw/hlthef/> [November 30, 2014]
- [61] association, W.q. Technical application bulletin: Chromium 2005. Available from: <http://www.wqa.org/pdf/techbulletins/tb-chromium.pdf> [July 12, 2014]

- [62] Cesph-Romero, R.M., Yebra-Biurrun, M.C., and Bermejo-Barrera, M.P. Preconcentration and speciation of chromium by the determination of total chromium and chromium(II) in natural waters by flame atomic absorption spectrometry with a chelating ion-exchange flow injection system Analytica Chimica Acta 327 (1996): 37-45.
- [63] Gherasim, C.V., Bourceanu, G., Olariu, R.I., and Arsene, C. A novel polymer inclusion membrane applied in chromium (VI) separation from aqueous solutions. Journal of Hazardous Materials 197 (2011): 244-253.
- [64] USEPA. Method 7196A chromium, hexavalent (calorimetric) 1992. Available from: www.epa.gov/region9/qa/pdfs/dqi/hexavalent.pdf [December 6, 2014]
- [65] Svehla, G. VOGEL's qualitative inorganic. 7th ed. Edinburgh Gate, Harlow Essex CM20 2JE, England: Addison Wesley Longman Ltd., 1997.
- [66] Jung, S.-W., Lim, H.-W., Kang, C.-H., and Choi, Y.-W. Spectrophotometric determination of ultra trace tri & hexavalent chromium by using on-line flow injection analysis with dual pre-concentration column. Bulletin of the Korean Chemical Society 32(9) (2011): 3437-3442.
- [67] Gustavo González, A. and Ángeles Herrador, M. A practical guide to analytical method validation, including measurement uncertainty and accuracy profiles. TrAC Trends in Analytical Chemistry 26(3) (2007): 227-238.
- [68] Taverniers, I., De Loose, M., and Van Bockstaele, E. Trends in quality in the analytical laboratory. II. Analytical method validation and quality assurance. TrAC Trends in Analytical Chemistry 23(8) (2004): 535-552.
- [69] Smallwood, I.M. Handbook of organic solvent properties. Great, Britain: Arnold, 1996.
- [70] Dielectric constants and refractive index Available from: <http://www.stenutz.eu/chem/solv23.php> [April 14, 2014]
- [71] Arous, O., Saoud, F.S., Amara, M., and Kerdjoudj, H. Efficient facilitated transport of lead and cadmium across a plasticized triacetate membrane mediated by D2EHPA and TOPO. Materials Sciences and Applications 02(06) (2011): 615-623.

- [72] Jorge, M., Gulaboski, R., Pereira, C.M., and Cordeiro, M.N. Molecular dynamics study of 2-nitrophenyl octyl ether and nitrobenzene. Journal of Physical Chemistry B 110(25) (2006): 12530-12538.
- [73] ChemicalBook. Aliquat 336(5137-55-3) 2008. Available from: http://www.chemicalbook.com/ProductMSDSDetailCB4412612_EN.htm [April 13, 2015]
- [74] Jung, G.Y., Kim, Y.S., and Lim, H.B. Simultaneous determination of chromium(III) and chromium(VI) in aqueous solution by capillary electrophoresis with on-column uv-vis detection. Analytical Sciences 13 (1997): 463-467.



APPENDIX

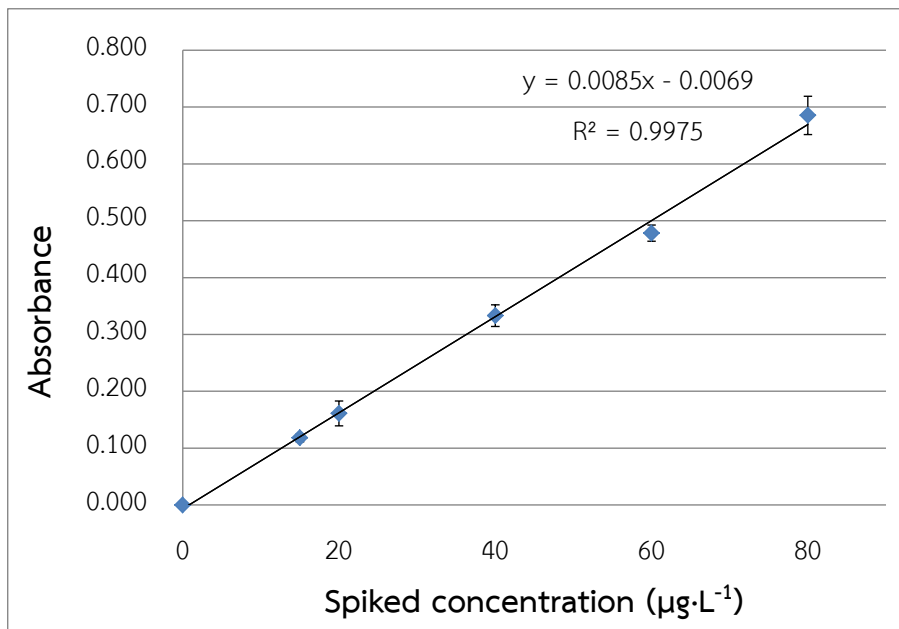

Figure A.1 Matrix-match standard calibration curve of Cr(VI) in EME analysis of drinking water

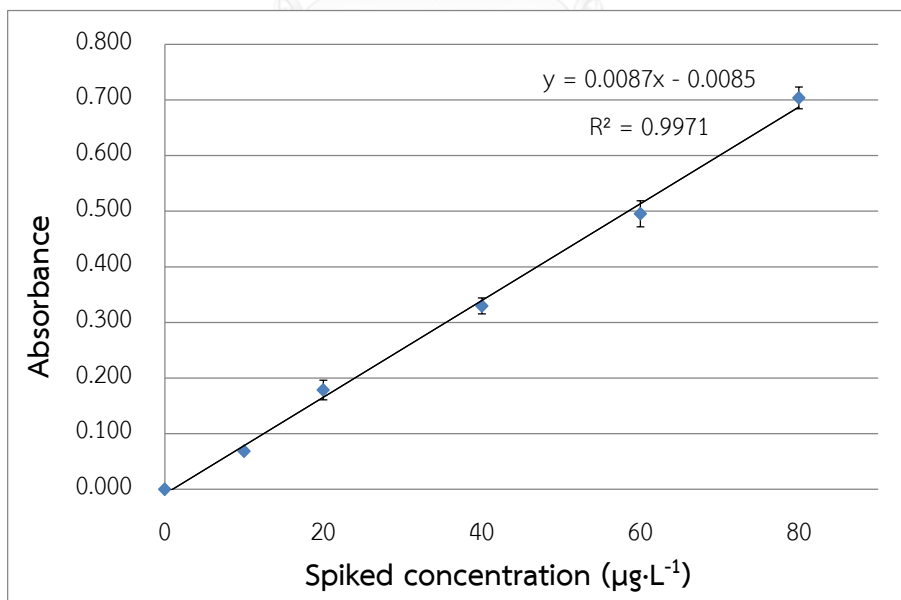

Figure A.2 Matrix-match standard calibration curve of Cr(VI) in EME analysis of mineral water

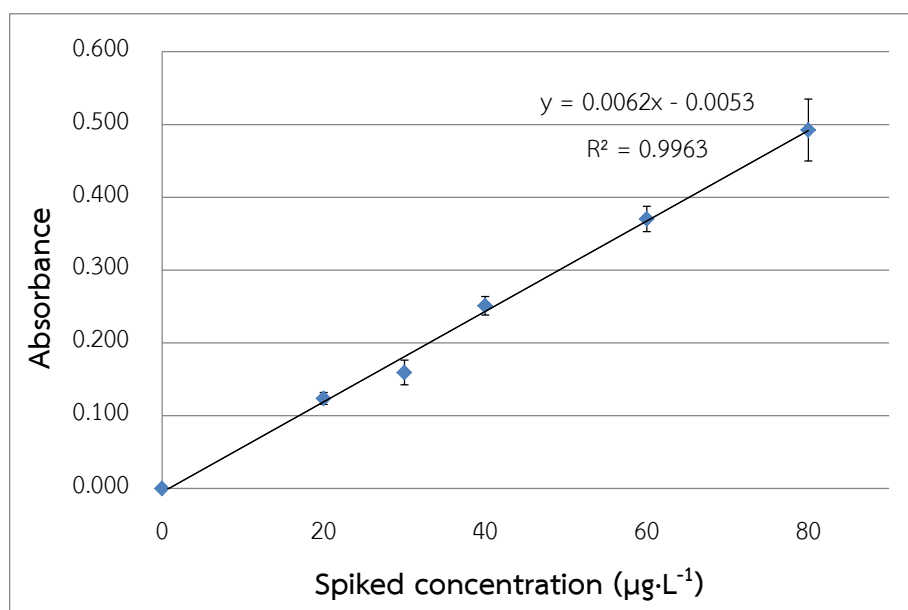

Figure A.3 Matrix-match standard calibration curve of Cr(VI) in EME analysis of CU pond

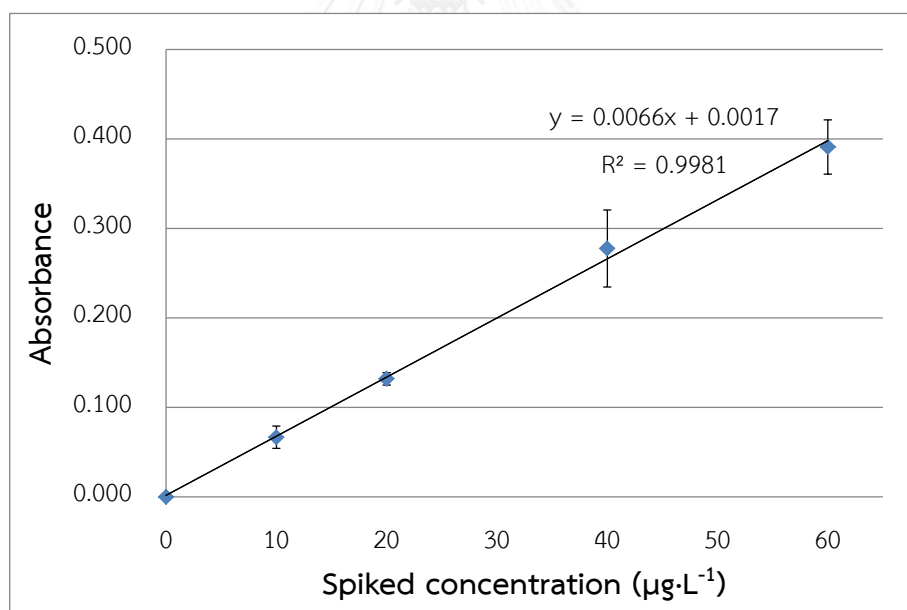

Figure A.4 Matrix-match standard calibration curve of Cr(VI) in EME analysis of tap water

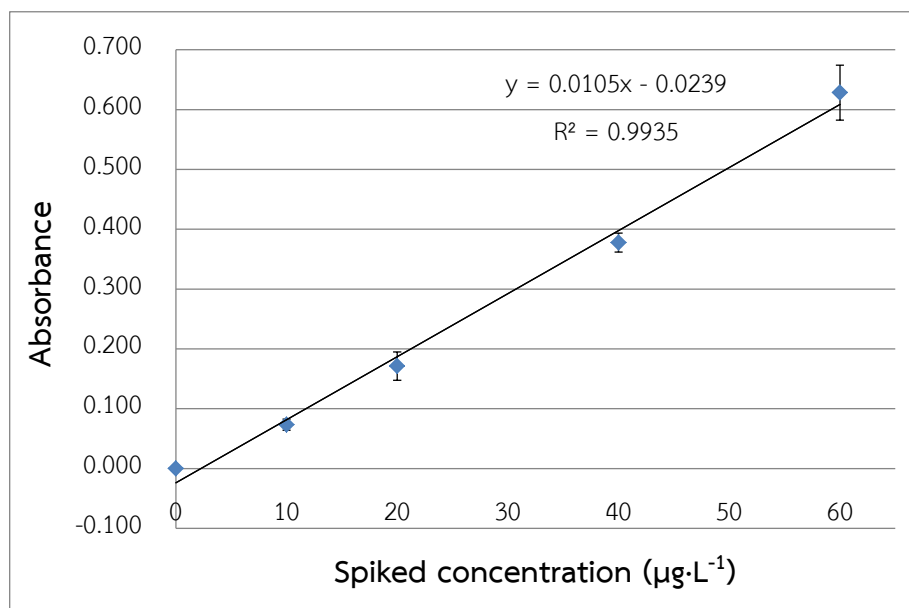

Figure A.5 Matrix-match standard calibration curve of Cr(VI) in EME analysis of dam water



VITA

Miss Ungkhana Atikarnsakul was born on October 30, 1990, in Bangkok, Thailand. She had graduated a Bachelor's degree of Science in Chemistry from Chulalongkorn University in 2012 with second class honor. Afterwards, she has continued her academic education for Master degree in Analytical Chemistry at Department of Chemistry, Faculty of Science, Chulalongkorn University and she becomes a member of Chromatography and Separation Research Unit (ChSRU) and PV lab.

Poster presentation and proceeding

“Electromembrane extraction profiles of chromate ion from samples with various conductivities” Ungkhana Atikarnsakul, Pakorn Varanusupakul. Poster presentation and proceeding, Pure and Applied Chemistry International Conference 2015 (PACCON2015), Amari Watergate Hotel, Bangkok, Thailand, 21-23 January, 2015.

“Development of electromembrane extraction for isolation of Chromium (VI) ion from high ionic samples” Ungkhana Atikarnsakul, Pakorn Varanusupakul. Poster presentation, 21st International Symposium on Separation Sciences 2015, Grand Hotel Union, Ljubljana, Slovenia, 30 June-3 July, 2015.