

## CHAPTER IV

### EXPERIMENTS

#### 4.1 Preparation of Na-ZSM-5 and Na-Cu-Silicate Catalysts

ZSM-5 was prepared by the rapid crystallization method [51] developed by Prof. Tomoyuki Inui's laboratory and Cu-silicate was prepared by replacing the aluminum ingredient with copper salt at the gel formation stage of the ZSM-5 preparation. The preparation procedure is shown in Figure 4.1, while reagents are shown in Tables 4.1 and 4.2. As the source of metals,  $\text{AlCl}_3$  for Al and  $\text{Cu}(\text{NO}_3)_2 \cdot 3\text{H}_2\text{O}$  for Cu were used, respectively. TPABr (Tetra-n-Propyl Ammonium Bromide)  $[(\text{CH}_3\text{CH}_2\text{CH}_2)_4\text{N}]\text{Br}$  was used as organic template. The charged metal contents, expressed as atomic ratio of Si/metal, were 20, 50, 3200, and  $\infty$  for Al-, and 50 for Cu-silicates, respectively.

##### 4.1.1 Preparation of Gel Precipitation and Decantation Solution

The preparation of supernatant liquid was separated from that of gel, which was important to prepare the uniform crystals. The detailed procedures were as follows: Firstly, a gel mixture was prepared by adding solution A-1 and solution B-1 into solution C-1 dropwise with vigorous stirring using magnetic stirrer at room temperature as shown in Figure 4.2. The pH of the mixed solution was maintained within 9-11, since it is expected that this pH value is suitable for precipitation. The gel mixture was separated from the

supernatant liquid by centrifuge. The precipitated gel mixture was milled for totally 1 h by powder miller (Yamato-Notto, UT-22), Figure 4.3. The milling procedure are as follows: milled 15 min → centrifuge (to remove the liquid out) → milled 15 min → centrifuge → milled 30 min. Milling the gel mixture before the hydrothermal treatment was essential to obtain the uniform and fine crystals. Secondly, a decantation solution was prepared by adding solution A-2 and solution B-2 into solution C-2 as the same method of the preparation of gel mixture. The supernatant liquid from A-2, B-2, and C-2 was mixed together with the milled gel mixture, expecting that before mixing adjust the pH of solution between 9-11 with  $\text{H}_2\text{SO}_4$  (conc.) or 1 M NaOH solution.

#### 4.1.2 Crystallization

The mixture of the milling precipitate and the supernatant of decant solution was charged in an one litre stainless steel autoclave. The atmosphere in the autoclave was replaced by nitrogen gas and pressurized upto  $3 \text{ kg/cm}^2$  gauge. Then the mixture in the autoclave was heated from room temperature to  $160 \text{ }^\circ\text{C}$  in 90 min and then up to  $210 \text{ }^\circ\text{C}$  with a constant heating rate of  $12 \text{ }^\circ\text{C/h}$  while being stirred at 60 rpm, followed by cooling down the hot mixture to room temperature in the autoclave overnight. The temperature was programed under the hydrothermal treatment to minimize the time which was necessary for the crystallization. The produced crystals were washed with de-ionized water about 8 times by using the centrifugal separator (about 15-20 min for each time), to remove  $\text{Cl}^-$  out of the crystals, and dried in an oven at  $110 \text{ }^\circ\text{C}$  for at least 3 h.

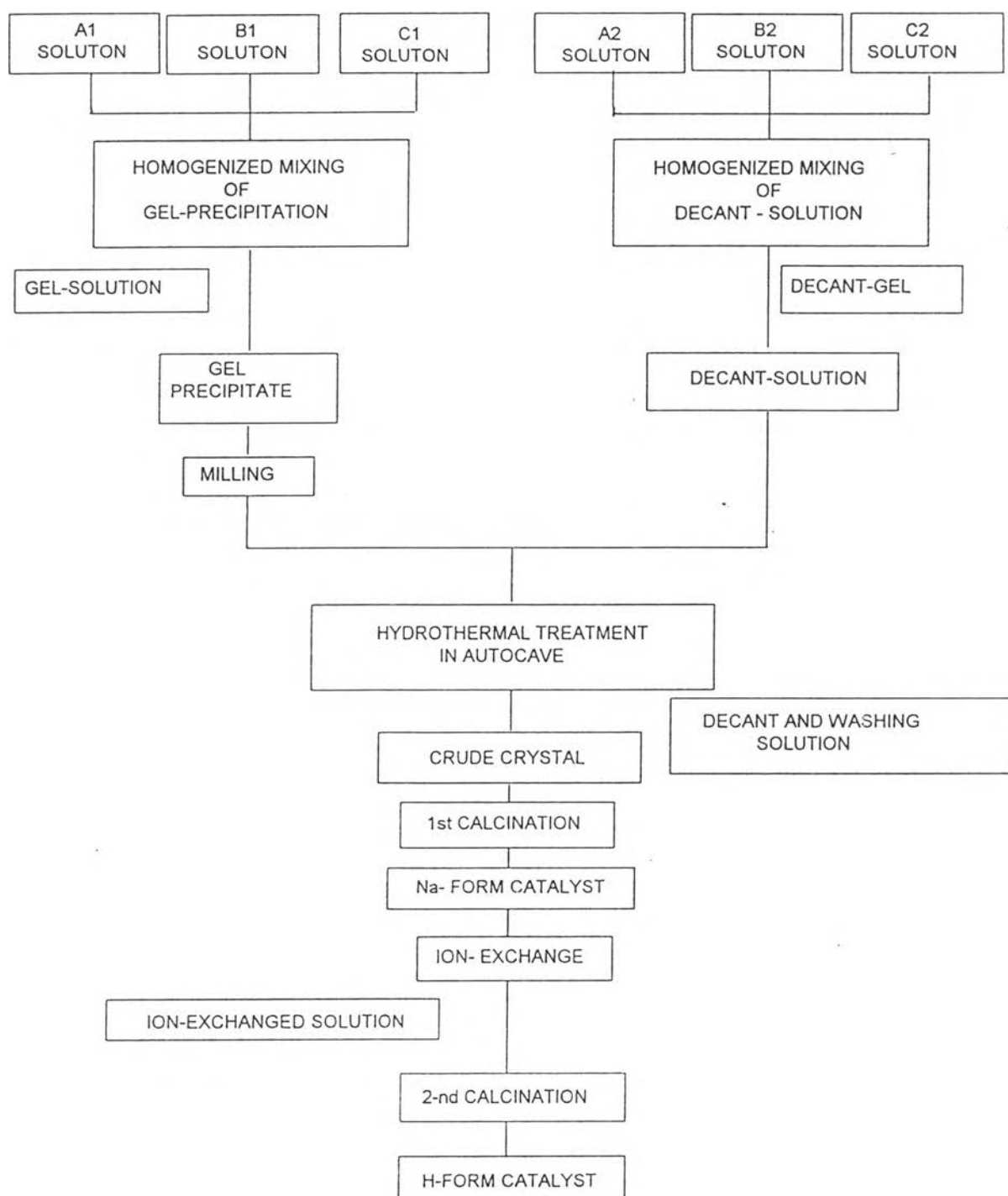

Figure 4.1 Preparation procedure of ZSM-5 and Cu-silicate by rapid crystallization method.

Table 4.1 Reagents used for the preparation of Na-ZSM-5 or Na-Al-silicate  
(Si/Al= 20-∞)

Solution for the gel preparation	Solution for decant-solution preparation
<p><u>Solution A1</u></p> <p>AlCl<sub>3</sub>                                    x g</p> <p>TPABr                                    5.72 g</p> <p>NaCl                                        11.95 g</p> <p>De-ionized water                    60 ml</p> <p>H<sub>2</sub>SO<sub>4</sub> (conc.)                        6.2 g</p>	<p><u>Solution A2</u></p> <p>AlCl<sub>3</sub>                                    x g</p> <p>TPABr                                    7.53 g</p> <p>De-ionized water                    60 ml</p> <p>H<sub>2</sub>SO<sub>4</sub>(conc.)                        6.2 g</p>
<p><u>Solution B1</u></p> <p>Sodium silicate                        69 g</p> <p>De-ionized water                    45 ml</p>	<p><u>Solution B2</u></p> <p>Sodium silicate                        69 g</p> <p>De-ionized water                    45 ml</p>
<p><u>Solution C1</u></p> <p>TPABr                                    2.16 g</p> <p>NaCl                                        40.59 g</p> <p>NaOH                                       2.39 g</p> <p>De-ionized water                    208 ml</p> <p>H<sub>2</sub>SO<sub>4</sub>(conc.)                        1.8 g</p>	<p><u>Solution C2</u></p> <p>NaCl                                        26.27 g</p> <p>De-ionized water                    104 ml</p>

x ; based on Si/Al charged ratio

Table 4.2 Reagents used for the preparation of Na-Cu-silicate (Si/Cu = 50)

Solution for the gel preparation	Solution for decant-solution preparation
<p><u>Solution A1</u></p> <p>Cu(NO<sub>3</sub>)<sub>2</sub> · 3H<sub>2</sub>O      1.59 g</p> <p>NaCl                              1 g</p> <p>De-ionized water      60 ml</p> <p>H<sub>2</sub>SO<sub>4</sub>(conc.)      3.38 ml</p>	<p><u>Solution A2</u></p> <p>Cu(NO<sub>3</sub>)<sub>2</sub> · 3H<sub>2</sub>O      1.59 g</p> <p>De-ionized water      60 ml</p> <p>H<sub>2</sub>SO<sub>4</sub>(conc.)      3.38 ml</p>
<p><u>Solution B1</u></p> <p>Sodium silicate      69 g</p> <p>De-ionized water      45 ml</p>	<p><u>Solution B2</u></p> <p>Sodium silicate      69 g</p> <p>De-ionized water      45 ml</p>
<p><u>Solution C1</u></p> <p>TPABr                      7.90 g</p> <p>NaCl                      51.54 g</p> <p>NaOH                      2.40 g</p> <p>De-ionized water      208 ml</p> <p>H<sub>2</sub>SO<sub>4</sub>(conc.)      1.55 ml</p>	<p><u>Solution C2</u></p> <p>TPABr                      7.52 g</p> <p>NaCl                      26.27 g</p> <p>De-ionized water      104 ml</p>

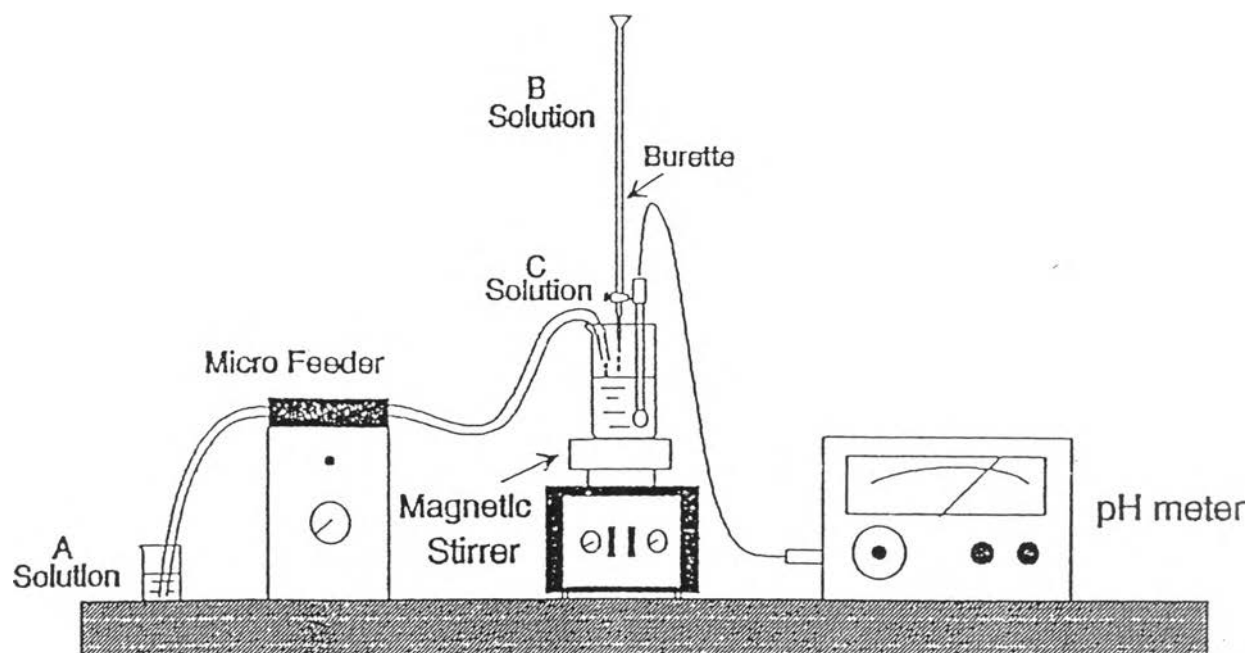

Figure 4.2 A set of apparatus used for preparation of supernatant solution and gel precipitation as providing for the rapid crystallization.

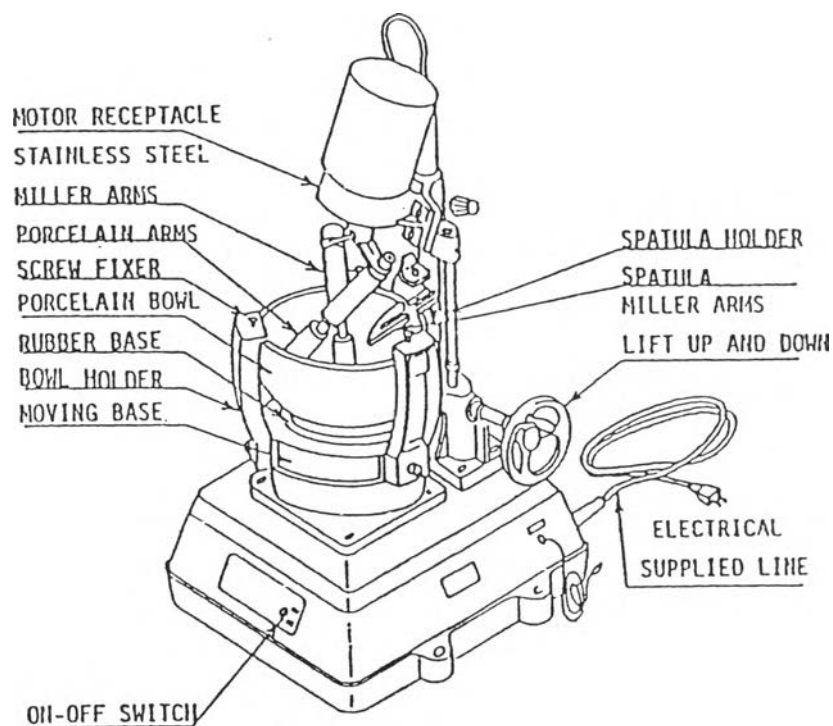

Figure 4.3 A powder miller (Yamato-Notto, UT-22).

### 4.1.3 Calcination

The dry crystals were calcined in an air stream at 540 °C for 3.5 h, by heating them from room temperature to 540 °C in 60 min, to burn off the organic template and leave the cavities and channel in the crystals. The calcined crystals were cooled to room temperature in a desiccator. The obtained catalysts have been called Na-ZSM-5 and Na-Cu-silicate, respectively. The Na-ZSM-5 having the charged Si/Al atomic ratios of 20 to  $\infty$  were prepared by this method.

The Na-Zeolite was converted into the hydrogen form by using ion-exchange method. A 3.0 g portion of the calcined crystals were ion-exchanged twice in 90 ml of 1 M  $\text{NH}_4\text{NO}_3$  aqueous solution at 80 °C for 1 h, washed with de-ionized water, dried overnight at 110 °C, and calcined at 540 °C for 3.5 h.

## 4.2 Loading Cu by Ion-exchange Method

The zeolite was ion-exchanged at room temperature [52] with the procedure as shown in Figure 4.4. Approximately 2 g of ZSM-5 zeolite was stirred with 200 ml of de-ionized water about 30 min and standed for overnight, and then boiled for 3 h in new de-ionized water. This was stirred for overnight in 200 ml of 0.1 M  $\text{NaNO}_3$  solution and washed with 50 ml of  $\text{NaNO}_3$  solution. The metal exchange was carried out at room temperature for overnight with 100 ml of an aqueous copper nitrate solution of an adequate concentration. The wet cake obtained by separation from the solution was again ion-exchanged in new copper nitrate solution. Finally, the ion-exchanged zeolite was washed with de-ionized water and dried at 110 °C overnight.

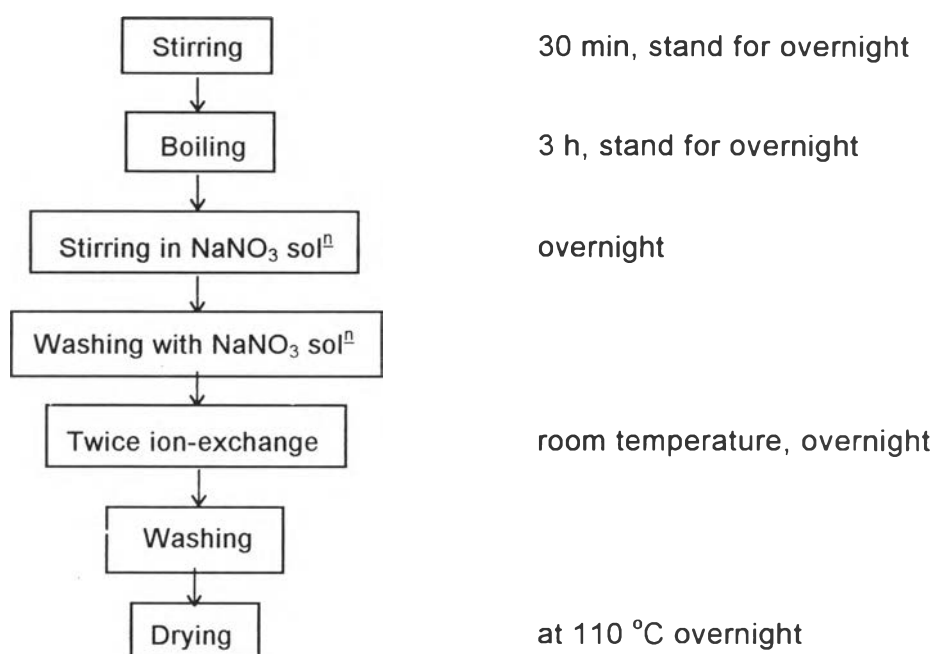

Figure 4.4 A diagram for metal ion-exchanged on catalyst.

The catalysts were tabletted by a tablet machine, then crushed and sieved in a grain-size of 8-16 mesh to provide for the reaction.

### 4.3 Nitric Oxide Reduction

#### 4.3.1 Chemicals and Reagents

Nitric oxide (1%) in helium, Hydrocarbon (3%) in helium, and oxygen of ultra high purity grade (99.999%) were provided by Thai Industrial Gases Limited.

#### 4.3.2 Instruments and Apparatus

1. Reactor : The NO reduction reactor is a conventional microreactor made from quartz tube with 6 mm. inside diameter. The reaction was carried out under ordinary gas flow and atmospheric pressure. The effluent



gas was sampled and analyzed by on-line gas chromatography.

2. Automation Temperature Controller : This consists of a magnetic switch connected to a variable voltage transformer and a RKC temperature controller series REX-C900 connected to a thermocouple attached to the catalyst bed in reactor. A dial setting establishes a set point at any temperature within the range between 0 °C to 1000 °C.

3. Electrical furnace : This supplies the required heating to the reactor for NO reduction reaction. The reactor can be operated from room temperature up to 700 °C at maximum voltage of 200 volts.

4. Gas Controlling System : Nitric oxide, hydrocarbon, oxygen and helium cylinders each is equipped with a pressure regulator (0-120 psig), an on-off valve and needle valve were used to adjust flow rate of gas. Sampling valve was used to take sample of effluent gas.

5. Gas Chromatography : thermal conductivity detector (TCD) gas chromatographs, SHIMADZU GC-8APT and SHIMADZU GC-8AIT, and flame ionization detector (FID) gas chromatograph, GOW-MAC Series 750 were used to analyze feed and effluent gas. Operating condition used are shown in Table 4.3.

The chromatograms of gas chromatography obtained from gas analysis are shown in Appendix D.

#### 4.3.3 Procedure

A 0.5 g portion of the catalyst was packed in a quartz tube reactor. Before the reaction, the catalyst was heated in He flow at room temperature to 500 °C in 1 h, held at this temperature for 1 h and then cooled down to 100 °C. The catalytic reaction was then started. A gas mixture

Table 4.3 Operating conditions of gas chromatograph

## a) Thermal conductivity detector gas chromatograph

Gas chromatography	SHIMADZU GC-8APT	SHIMADZU GC-8AIT
Detector	TCD	TCD
Packed column	MS-5A	PORAPAK - Q
Carrier gas	He (99.999%)	He (99.99%)
Flow rate of carrier gas	30 ml/min	60 ml/min
Column temperature	60 °C	90 °C
Detector temperature	100 °C	100°C
Injector temperature	100 °C	100 °C
Analyzed gas	O <sub>2</sub> , N <sub>2</sub> , CH <sub>4</sub> , CO	C <sub>3</sub> H <sub>8</sub> , CO <sub>2</sub>

## b) Flame ionization detector gas chromatograph

Gas chromatography	GC GOW-MAC Series 750
Detector	FID
Packed column	VZ-10
Nitrogen flow rate	25 ml/min
Hydrogen flow rate	30 ml/min
Air flow rate	250 ml/min
Column temperature	50°C
Detector temperature	80°C
Injector temperature	80°C
Analyzed gas	hydrocarbons

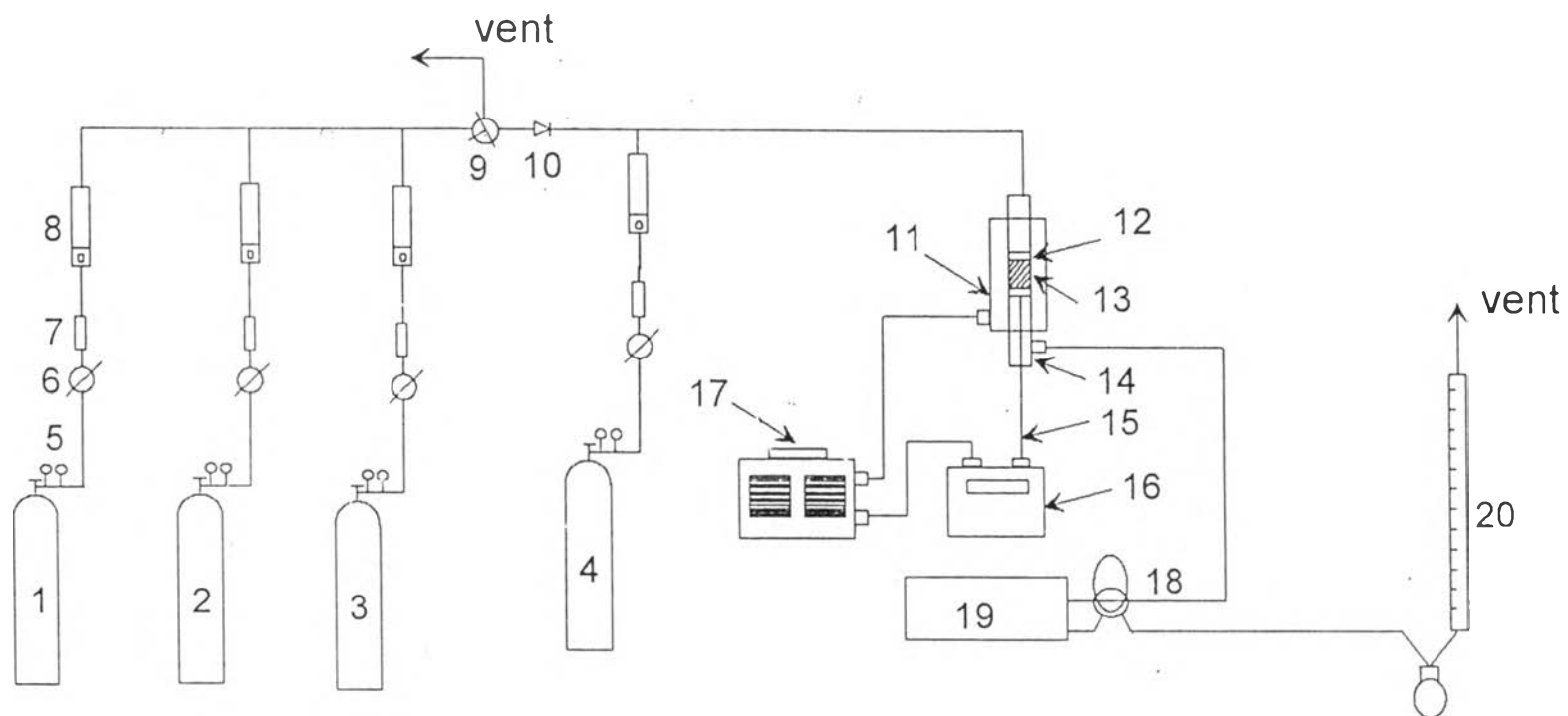

- |                                       |                    |                     |                               |
|---------------------------------------|--------------------|---------------------|-------------------------------|
| 1. NO tank                            | 6. On off valve-   | 11. Reactor furnace | 16. Temperature controller    |
| 2. C <sub>3</sub> H <sub>8</sub> tank | 7. Gas filter      | 12. Quartz wool     | 17. Variable voltage transfer |
| 3. O <sub>2</sub> tank                | 8. Flow meter      | 13. Catalyst bed    | 18. Sampler                   |
| 4. He tank                            | 9. Three way valve | 14. Reactor         | 19. G.C.                      |
| 5. Pressure regulator                 | 10. Check valve    | 15. Thermocouple    | 20. Soap film flow meter      |

Figure 4.5 Flow diagram of the nitric oxide reduction system.

containing NO (1000 ppm), C<sub>3</sub>H<sub>8</sub> (3000 ppm), and O<sub>2</sub> (10 volume%), diluted with He, was allowed to flow through the catalyst bed at a flow rate of 50 ml/min (GHSV ~ 4,000 h<sup>-1</sup>). For studying the effect of hydrocarbons, the number of carbon atom was kept constant in all cases by adjusting the hydrocarbon concentration. The reaction temperature was increased stepwise from 150 to 600 °C. The catalysts were heated up every 20 min (50 °C per time interval). At each of the reaction temperatures, the gas composition was analyzed by gas chromatography using Porapak-Q (CO<sub>2</sub> and C<sub>3</sub>H<sub>8</sub>), Molecular Sieve-5A (O<sub>2</sub>, N<sub>2</sub>, CH<sub>4</sub>, and CO) and VZ-10 (hydrocarbons) columns. The concentration of hydrocarbons at the inlet and outlet stream was therefore analyzed for hydrocarbons combustion. The catalytic activity for NO removal was evaluated by extent of conversion into N<sub>2</sub>. The flow diagram of nitric oxide reduction system was shown in Figure 4.5.

#### **4.4 Characterization of the Catalysts**

##### **4.4.1 X-ray Diffraction Patterns**

X-ray diffraction (XRD) patterns of the catalysts were performed at Sedimentology laboratory of Department of Geology, Faculty of Science, Chulalongkorn University.

##### **4.4.2 Specific Surface Area and Pore Size Distribution Measurement**

Surface areas and pore size distribution of the catalysts were measured by the BET method, with nitrogen as the adsorbent using a micromeritics model ASAP 2000 at liquid-nitrogen temperature at Analysis Centre of Department of Chemical Engineering, Faculty of Engineering,

Chulalongkorn University.

#### 4.4.3 Morphology

The shape and the distribution of the size of the crystals were observed by JEOL Scanning Electron Microscope (SEM) at the Scientific and Technological Research Equipment Centre, Chulalongkorn University (STREC).

#### 4.4.4 Infrared Spectroscopy

The structure details of the catalysts were investigated by Nicolet FT-IR spectroscopy. The samples were prepared by dilution of the samples in KBr for examining the infrared spectrum of the framework vibration region.

#### 4.4.5 Chemical Analysis

Percentage of metals loading was analyzed by atomic absorption spectrometry (AAS) method. The catalyst was dissolved by the following procedure:

A certain amount of catalyst (about 100 mg) was digested by digesting solution containing solution of 20 ml of conc. HCl, 10 ml of conc. HNO<sub>3</sub>, and 10 ml of H<sub>2</sub>O. The mixture was heated up until the color of the support changed into white. During heating step, H<sub>2</sub>O had to be added into the mixture to maintain the volume of mixture. Then, 5 drops of HF were added into the mixture in order to digest the support. Heating step was repeated until the solution became clear. Then volume of the solution was made up to 50 ml by adding de-ionized water.

The copper content of the prepared solution was analyzed by

atomic absorption spectrometry (AAS) at the Scientific and Technological Research Equipment Centre, Chulalongkorn University.

#### 4.4.6 Temperature-Programmed Desorption of Carbon Dioxide

The TPD of CO<sub>2</sub> was intended to measure the adsorbable strength and the amount of CO<sub>2</sub> adsorbed on catalysts. Because the desorption of the adsorbed gas is stimulated by elevating temperature. Thus, the proportion of the desorbed gas at various temperatures establishes a good measurement of the adsorbable strength of the catalyst.

Procedure : The temperature-programmed desorption (TPD) of carbon dioxide on a catalyst was performed in a quartz tube reactor packed with 0.2 g of catalyst sample and connected to an ordinary vacuum line or adsorption unit as shown in Figure 4.6. The catalyst was treated in air stream under atmospheric pressure with a flow rate of 30 ml/min for 1 hour at 300 °C and then evacuated at the same temperature under pressure of  $6.13 \times 10^4 \text{ N.m}^{-2}$  (-30 mm. Hg) for 30 min. Carbon dioxide was introduced into the reactor under a pressure of  $2.01 \times 10^5 \text{ N.m}^{-2}$  (100 kPa), while simultaneously cooling the reactor to room temperature. The tube containing catalyst was evacuated for 10 min and repeatedly introduced with carbon dioxide at pressure of  $2.01 \times 10^5 \text{ N.m}^{-2}$  for 30 min in order to completely absorb carbon dioxide on the site of catalyst surface.

After the adsorption stage, the reactor was removed from the adsorption unit and connected to a desorption unit (Figure 4.7). Helium was introduced into the reactor at a flow rate of 20 ml/min. The temperature of catalyst was increased at a rate of 10 °C/min. The amount of desorbed carbon dioxide was measured by thermal conductivity detector.

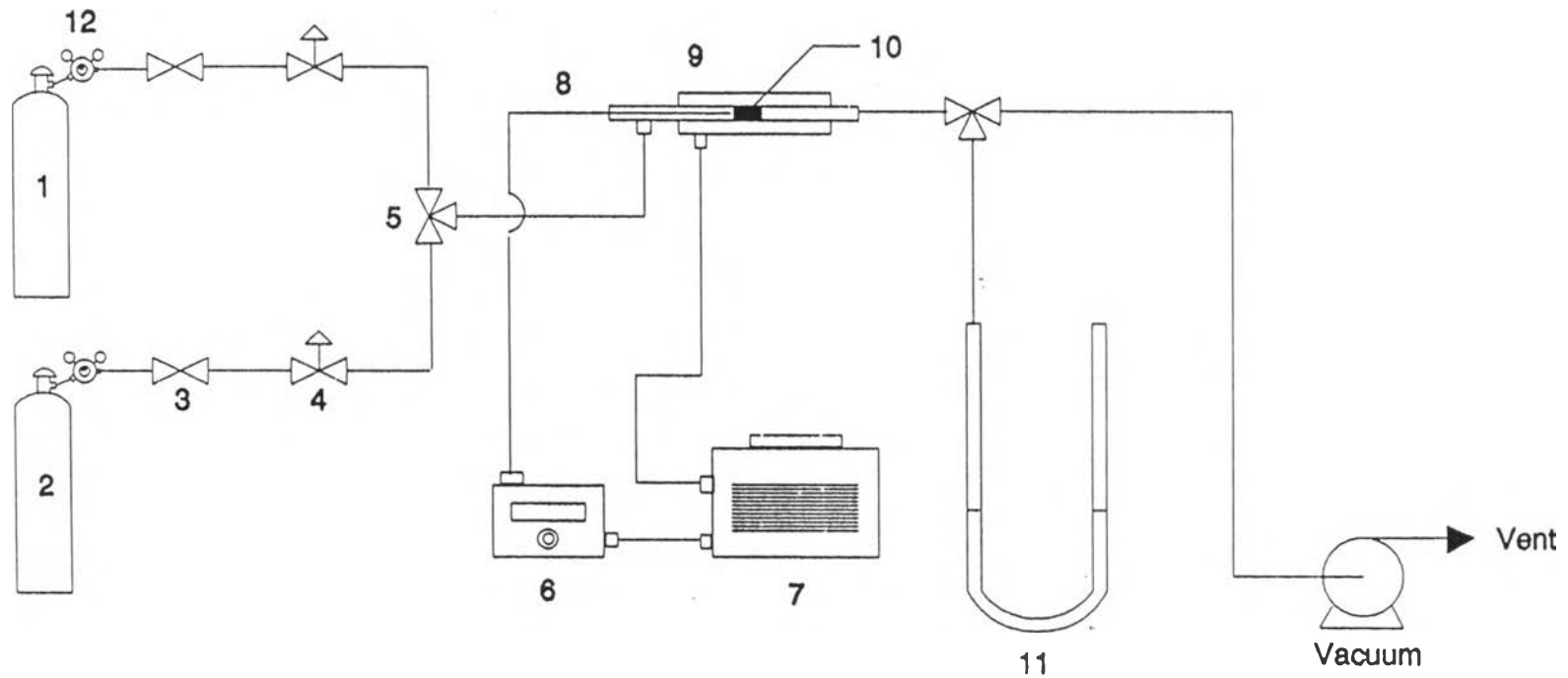

- |                         |                                 |                        |
|-------------------------|---------------------------------|------------------------|
| 1. CO <sub>2</sub> tank | 5. Three way valve              | 9. Heater              |
| 2. Air tank             | 6. Temperature controller       | 10. Catalyst bed       |
| 3. On-off valve         | 7. Variable voltage transformer | 11. Manometer          |
| 4. Needle valve         | 8. Thermocouple                 | 12. Pressure regulator |

Figure 4.6 Flow diagram of adsorption unit of temperature-programmed desorption system.

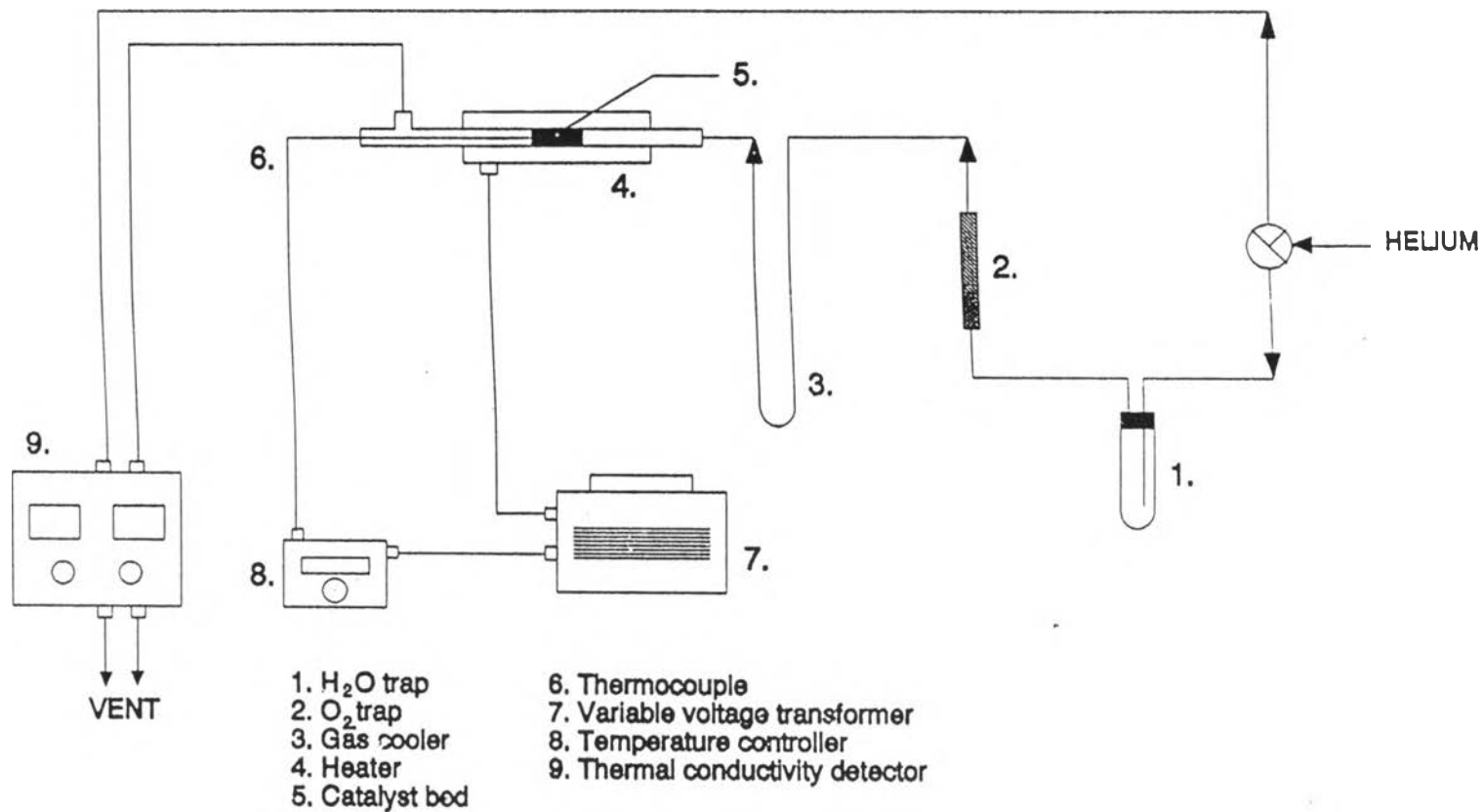

Figure 4.7 Flow diagram of desorption unit of temperature-programmed desorption system.



#### 4.4.7 Temperature-Programmed Oxidation (TPO)

An inevitable phenomenon when a catalyst is used with a hydrocarbon feed stock is the deactivation by the deposition of some carbonaceous compounds, commonly called "coke". However, coke removal can be accomplished by burning the coked catalyst, using a gas mixture containing oxygen, at a suitable temperature over a period of time. The temperature-programmed oxidation technique can give information of the total amount of coke by measuring the amounts of carbon dioxide produced.

Table 4.4 Operating condition of gas chromatograph

Gas chromatography	SHIMADZU GC-8AIT
Detector	TCD
Packed column	PORAPAK - QS
Helium flow rate	60 ml/min
Column temperature	90 °C
Detector / injector temperature	110 °C
Detector current	90 mA

Procedure : The temperature-programmed oxidation of the catalyst was carried out in a quartz tube reactor with an outside diameter of 6 mm packed with spent catalyst. The reactor was placed in a furnace which various heating rates was controlled by a programmable temperature controller (PC-600, Shinko). The temperature-programmed oxidation process began by heating up the catalyst with 1% oxygen in helium gas 30 ml/min from room temperature to 700 °C at a constant heating rate of 5 °C/min. Gas

chromatograph (Shimadzu GC-8AIT) with Porapak QS column was used to measure the amount of CO<sub>2</sub> produced from coke combustion. The operating condition of the GC is shown in Table 4.4. When the catalyst temperature reached 50 °C, the effluent stream was first analysed and at interval of about 5 min until the temperature was raised to 700 °C. The catalyst sample was then cooled down in argon stream. The flow diagram of the system is shown in Figure 4.8.

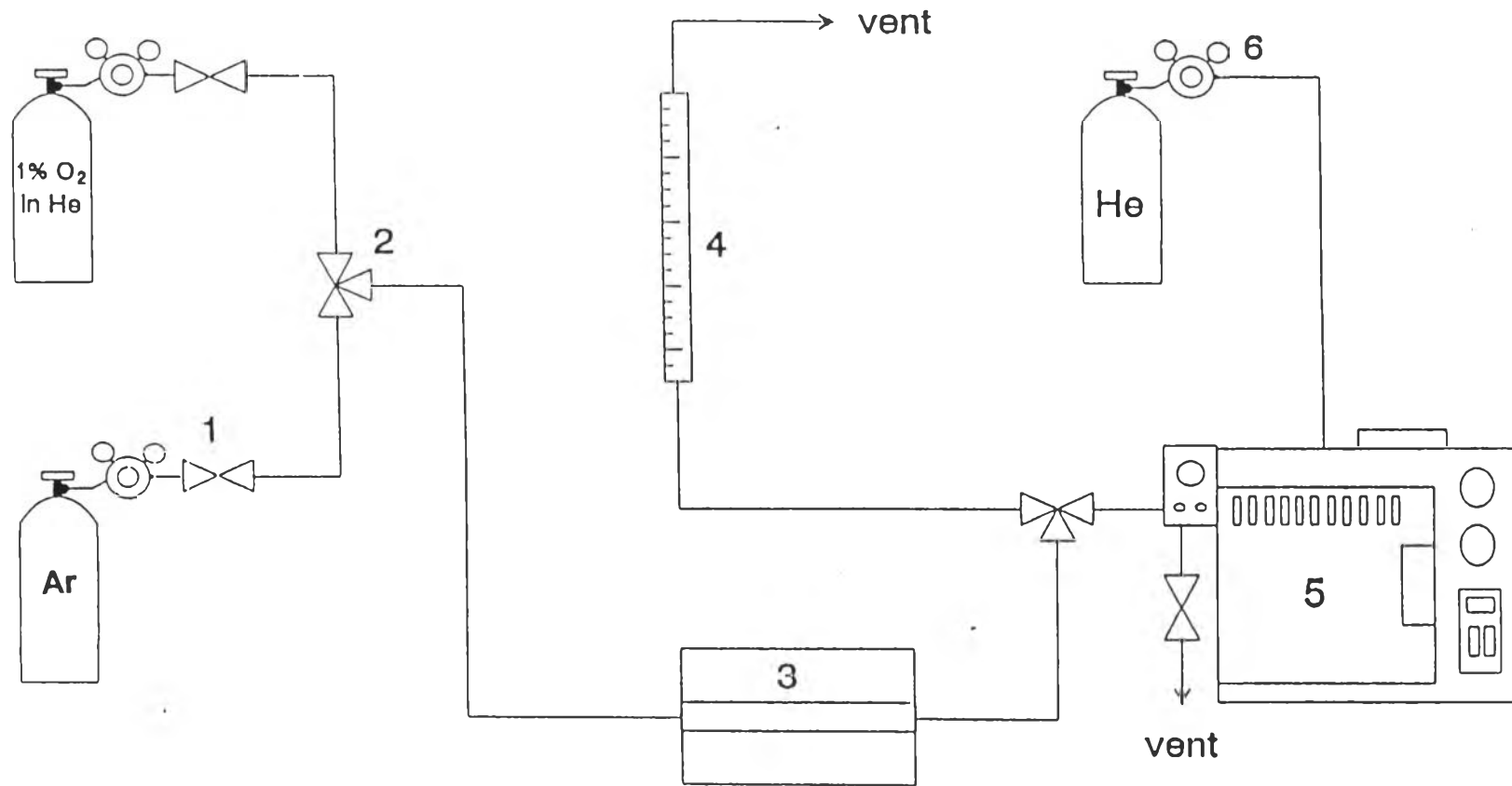

- |                        |                       |
|------------------------|-----------------------|
| 1. On-Off Valve        | 2. Three Way Valve    |
| 3. Furnace and Reactor | 4. Flow Meter         |
| 5. Gas Chromatography  | 6. Pressure Regulator |

Figure 4.8 Flow diagram of temperature-programmed oxidation system.