



## โครงการ

# การเรียนการสอนเพื่อเสริมประสบการณ์

ชื่อโครงการ	การพัฒนาวิธีตรวจวัดคาร์โบฟูแรนด้วยโวลแทมเมตรีโดยใช้ขั้วไฟฟ้าคาร์บอน พิมพ์สกรีนดัดแปรด้วยแกรฟีนควอนตัมดอต Method development for determination of carbofuran by voltammetry using graphene quantum dot-modified screen- printed carbon electrode
ชื่อนิสิต	นางสาวพรภัส สายแก้ว
ภาควิชา	เคมี
ปีการศึกษา	2559

คณะวิทยาศาสตร์ จุฬาลงกรณ์มหาวิทยาลัย

METHOD DEVELOPMENT FOR DETERMINATION OF CARBOFURAN BY VOLTAMMETRY  
USING GRAPHENE QUANTUM DOT-MODIFIED SCREEN-PRINTED CARBON ELECTRODE

Miss Pornlapas Saikaew

A Project Submitted in Partial Fulfillment of the Requirements

for the Degree of Bachelor of Science Program in Chemistry

Department of Chemistry

Faculty of Science

Chulalongkorn University

Academic Year 2016

Copyright of Chulalongkorn University

**Project Title:** Method development for determination of carbofuran by voltammetry using graphene quantum dot-modified screen-printed carbon electrode

**By:** Miss Pornlapas Saikaew

**Field of study:** Chemistry

**Project Advisor:** Assistant Prof. Dr. Suchada Chuanuwatanakul

Accepted by Department of Chemistry, Faculty of Science, Chulalongkorn University in Partial Fulfillment of the Requirements for the Degree of Bachelor of Science program in Chemistry

.....Head of Department of Chemistry

(Associate Professor Vudhichai Parasuk, Ph.D)

...../...../.....

#### PROJECT COMMITTEE

*Passapol Ngamukot*

.....Chair committee

(Passapol Ngamukot. Ph.D.)

*Suchada Chuanuwatanakul*

.....Project Advisor

(Assistant Professor Suchada Chuanuwatanakul, Ph.D.)

*Numpon Insin*

.....Committee

(Numpon Insin, Ph.D)

Quality of the following work is rated:  Excellent  Good  Pass

ชื่อโครงการ การพัฒนาวิธีตรวจวัดคาร์โบฟูแรนด้วยโวลแทมเมตรีโดยใช้ขั้วไฟฟ้า  
คาร์บอนพิมพ์สกรีนตัดแปรด้วยแกรฟีนควอนตัมดอต

ชื่อนิติในโครงการ นางสาวพรภัส สายแก้ว เลขประจำตัว 5533120023

ชื่ออาจารย์ที่ปรึกษา ผู้ช่วยศาสตราจารย์ ดร.สุชาดา จุณนุวัฒน์กุล

ภาควิชาเคมี คณะวิทยาศาสตร์ จุฬาลงกรณ์มหาวิทยาลัย ปีการศึกษา 2559

### บทคัดย่อ

งานวิจัยนี้ได้พัฒนาขั้วไฟฟ้าแบบพิมพ์สกรีนโดยการตัดแปรด้วยของเหลวไอออนิกและแกรฟีนควอนตัมดอตเพื่อใช้ในการตรวจวัดปริมาณของคาร์โบฟูแรนซึ่งเป็นสารฆ่าศัตรูพืชและสัตว์ประเภทคาร์บาเมตชนิดหนึ่งที่มีความเป็นพิษสูง คาร์โบฟูแรนสามารถไฮโดรไลซ์ได้ภายใต้สภาวะที่เป็นเบสและมีอุณหภูมิสูงให้คาร์โบฟูแรนพินอลซึ่งให้สัญญาณทางเคมีไฟฟ้าได้ดีกว่ารูปที่ไม่ถูกไฮโดรไลซ์ ได้ศึกษาสภาวะที่เหมาะสมในการตัดแปรขั้วไฟฟ้าโดยใช้เทคนิคไซคลิกโวลแทมเมตรี พบว่า ใช้ของเหลวไอออนิก 10 มิลลิกรัม และสารละลายแกรฟีนควอนตัมดอต 7.5 ไมโครลิตร นอกจากนี้ ได้ศึกษาปฏิกิริยาทางเคมีไฟฟ้าของคาร์โบฟูแรนร่วมกับสารฆ่าศัตรูพืชและสัตว์ประเภทคาร์บาเมตที่สำคัญอีกหนึ่งชนิดคือคาร์เบนดาซิมด้วยเทคนิคดิฟเฟอเรนเชียลพัลส์โวลแทมเมตรีพบว่า พินอลของสารทั้งสองให้สัญญาณทางไฟฟ้าที่ดี

คำสำคัญ: คาร์โบฟูแรน, ขั้วไฟฟ้าคาร์บอนพิมพ์สกรีน,แกรฟีนควอนตัมดอต, ของเหลวไอออนิก, โวลแทมเมตรี

Title Method development for determination of carbofuran by  
voltammetry using graphene quantum dot-modified screen-printed  
carbon electrode

Student Name Miss Pornlapas Saikaew ID 5533120023

Advisor Assistant Prof. Dr. Suchada Chuanuwatanakul

Department of Chemistry, Faculty of Science, Chulalongkorn University, Academic Year 2016

### Abstract

The in-house screen-printed carbon electrode (SPCE) was successfully modified with ionic liquid and graphene quantum dots for the determination of carbofuran which is one of the toxic carbamate pesticides. Carbofuran can be hydrolyzed under basic condition at high temperature and turned to carbofuran-phenol which is more electrochemically active than carbofuran. The optimal electrode modification conditions were investigated by cyclic voltammetry. The optimal electrode used 10 mg ionic liquid and 7.5  $\mu\text{L}$  graphene quantum dots solution. Moreover, the study of electrochemical process of 2 carbamate pesticides namely carbofuran and carbendazim was performed by differential pulse voltammetry and their phenol forms showed good electrochemical response.

Keywords: carbofuran, screen-printed carbon electrode, graphene quantum dots, ionic liquid, voltammetry



## ACKNOWLEDGEMENTS

This project was supported by Department of Chemistry, Faculty of Science, Chulalongkorn University. First of all, I would like to thank you for a plenty of helpful guidance, kindness and encouragement I got from Assistant Prof. Dr. Suchada Chuanuwatanakul throughout this work. It was a great privilege working with her.

Moreover, I am highly indebted to the members of Electrochemistry and Optical Spectroscopy Research Unit for equipment, advices, and generousness.

Finally, the project might not be possible without the help and encouragement from many people both inside and outside the Research Unit, even though they weren't participate in my project, both graduated and ungraduated friends, and especially my family.



## CONTENTS

	<b>Page</b>
THAI ABSTRACT .....	iv
ENGLISH ABSTRACT .....	v
ACKNOWLEDGEMENTS .....	vi
LIST OF TABLES .....	ix
LIST OF FIGURES .....	x
LIST OF ABREVIATION .....	xiii
CHAPTER I .....	1
INTRODUCTION .....	1
1.1 Introduction .....	1
1.2 Literature Review .....	2
1.3 Theory .....	3
1.4 Objectives .....	10
CHAPTER II .....	11
EXPERIMENTAL .....	11
2.1 Instruments and apparatus .....	11
2.2 Chemicals .....	12
2.3 Chemical preparation .....	13
2.4 Synthesis of GQDs .....	15
2.5 Characterization of GQDs .....	15
2.6 Fabrication of the GQDs/IL-SPCE .....	15
2.7 Electrochemical measurements .....	17
2.8 Optimization of modified electrode .....	17
2.9 Optimization of the DPV parameter .....	18
CHAPTER III .....	19



RESULTS AND DISCUSSION .....	19
3.1 Characterization of synthesized GQDs .....	19
3.2 Optimization of modified electrode .....	20
3.3 The optimization of the DPV parameters .....	22
CHAPTER IV .....	28
CONCLUSION AND SUGGESTION FOR FURTHER STUDY .....	28
4.1 Conclusion .....	28
4.2 Suggestion for further study .....	28
APPENDIX .....	29
APPENDIX A .....	30
Optimization of modified electrode .....	30
APPENDIX B .....	31
The optimization of the DPV parameters .....	31
REFERENCES .....	33
VITA .....	35





## LIST OF TABLES

	Page
Table 1.1 The physiochemical properties of carbofuran (CAF) .....	4
Table 1.2 Methods of electrochemical technique .....	5
Table 2.1 List of instruments and apparatus using in synthesis of GQDs .....	11
Table 2.2 List of instruments and apparatus using in characterization of the synthesized GQDs .....	11
Table 2.3 List of instruments and apparatus used in preparation of sample solution .....	12
Table 2.4 List of instruments and apparatus used in fabrication of GQDs/IL-SPCE .....	12
Table 2.5 List of chemicals using in synthesis of GQDs .....	12
Table 2.6 List of chemicals used in preparation of sample solution .....	13
Table 2.7 List of chemicals using in fabrication of the GQDs/IL-SPCE .....	13

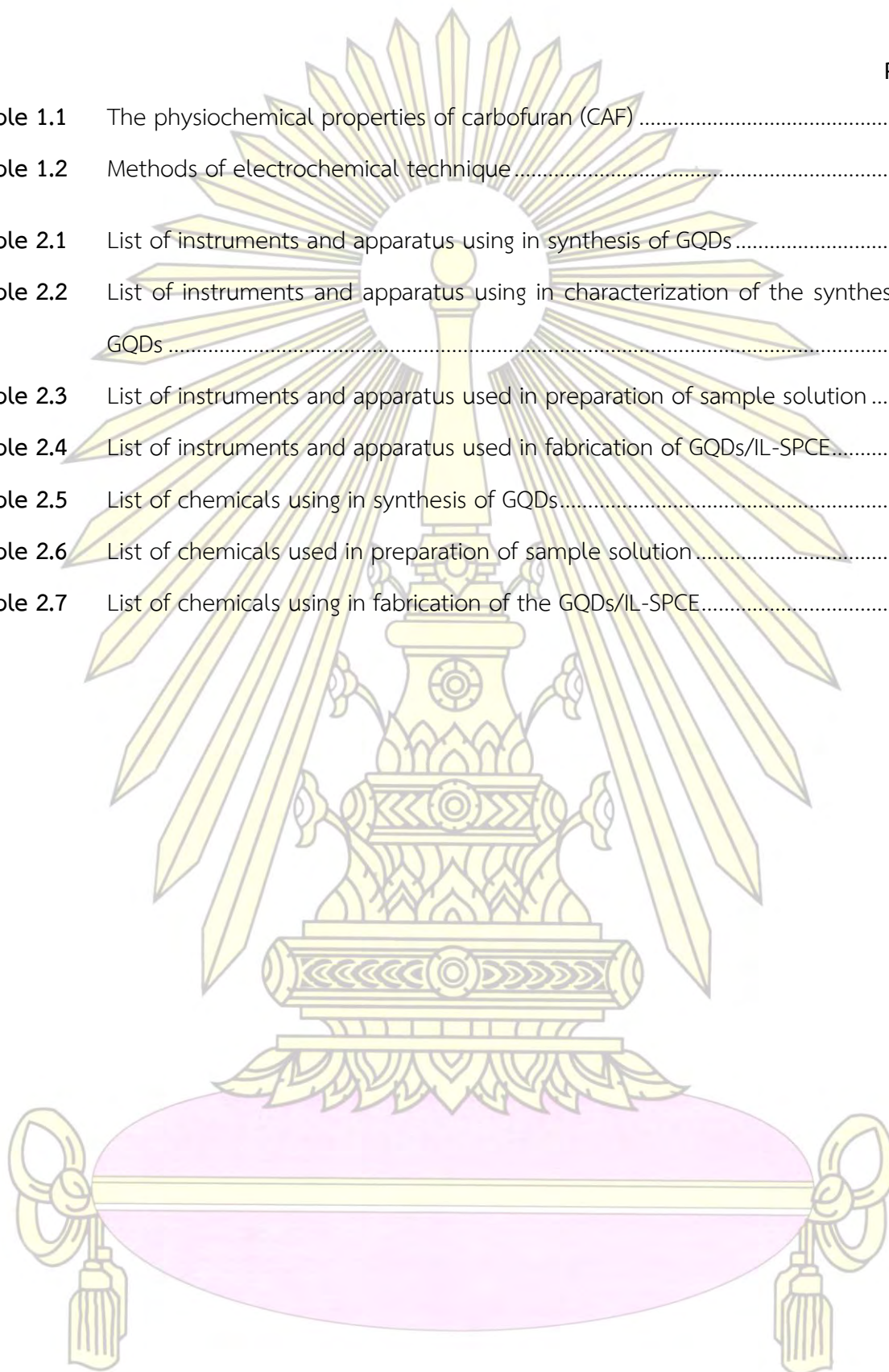

## LIST OF FIGURES

		Page
<b>Figure 1.1</b>	Scheme of the synthesis of graphene quantum dots (GQDs) and graphene oxide (GO) [6].....	3
<b>Figure 1.2</b>	Structure of carbofuran.....	4
<b>Figure 1.3</b>	Scheme of (a) hydrolysis of carbofuran (CAF) to form carbofuran-phenol and (b) oxidation of carbofuran-phenol [11].....	5
<b>Figure 1.4</b>	Potential waveforms for (a) linear sweep voltammetry, (b) cyclic voltammetry, (c) square-wave voltammetry and (d) differential pulse voltammetry.....	6
<b>Figure 1.5</b>	Traditional cyclic voltammogram of reversible redox system.....	7
<b>Figure 1.6</b>	(a) Waveform and (b) differential pulse voltammogram.....	8
<b>Figure 1.7</b>	Screen printed carbon electrode.....	9
<b>Figure 1.8</b>	Typical structure of a layer of a graphene quantum dots [13].....	9
<b>Figure 1.9</b>	Various applications of ionic liquid [16].....	10
<b>Figure 2.1</b>	The illustration of the 35 screen-printed carbon electrodes on a 12 cm x 14 cm PVC sheet.....	16
<b>Figure 2.2</b>	Each electrode consists of WE (working electrode) made of silver ink, RE (reference electrode) made of silver/silver chloride ink and CE (counter electrode) made of carbon ink.....	16
<b>Figure 3.1</b>	Photographs of the GQDs solution which were taken by smartphone under visible light (left) and under black light (right). ....	19
<b>Figure 3.2</b>	UV-Vis absorption (red line) and fluorescence spectra (blue line) of synthesized GQDs. ....	19
<b>Figure 3.3</b>	Effect of the amount of IL on the peak current of 3 mM carbofuran-phenol (CAF-phenol) in 0.1 M PB (pH 7.0) on GQDs/IL-SPCE prepared from the mixture of 0, 5, 10, 15, and 20 mg IL with 1 g of carbon ink and 7.5 $\mu$ L GQDs.....	20



- Figure 3.4** Plot of anodic peak currents of 3 mM carbofuran-phenol in 0.1 M PB (pH 7.0) on GQDs/IL-SPCE prepared by drop casting 0, 2.5, 5.0, 7.5 and 10.0  $\mu\text{L}$  of GODs.. 21
- Figure 3.5** The comparison of cyclic voltammograms of 3 mM carbofuran (CAF) in 0.1 M PB (pH 7.0) on a bare SPCE, IL-SPCE, GQDs-SPCE and GQDs/IL-SPCE using step potential of 5 mV and scan rate of 0.1 V/s. .... 22
- Figure 3.6** Plots of anodic peak currents (a) and peak potentials (b) of a mixture of 0.5 mM carbofuran-phenol (CAF-phenol) and 0.5 mM carbendazim-phenol (CAD-phenol) in 0.1 M PB (pH 7.0) by DPV on GQDs/IL-SPCE at various pulse potential in the range of 0.01 to 0.10 V. .... 23
- Figure 3.7** Plots of anodic peak currents (a) and peak potentials (b) of a mixture of 0.5 mM carbofuran-phenol (CAF-phenol) and 0.5 mM carbendazim-phenol (CAD-phenol) in 0.1 M PB (pH 7.0) by DPV on GQDs/IL-SPCE at various step potential in the range of 0.002 to 0.023 V. .... 24
- Figure 3.8** Plots of anodic peak currents (a) and peak potentials (b) of a mixture of 0.5 mM carbofuran-phenol (CAF-phenol) and 0.5 mM carbendazim-phenol (CAD-phenol) in 0.1 M PB (pH 7.0) by DPV on GQDs/IL-SPCE at various pulse time in the range of 0.005 to 0.030 V. .... 25
- Figure 3.9** Plots of anodic peak currents (a) and peak potentials (b) of a mixture of 0.5 mM carbofuran-phenol (CAF-phenol) and 0.5 mM carbendazim-phenol (CAD-phenol) in 0.1 M PB (pH 7.0) by DPV on GQDs/IL-SPCE at various scan rate in the range of 0.010 to 0.125 V/s. .... 26
- Figure A1** The CV responses of 3 mM carbofuran-phenol (CAF-phenol) in 0.1 PB solution (pH 7.0) on the SPCE modified with GQDs and various amounts of IL. .... 30
- Figure A2** The CV responses of 3 mM carbofuran-phenol (CAF-phenol) in 0.1 PB solution (pH 7.0) on the SPCE modified with IL and different volumes of GQDs. .... 30
- Figure A3** DPV responses of a mixture of 0.5 mM carbofuran-phenol (CAF-phenol) and 0.5 mM carbendazim-phenol (CAD-phenol) in 0.1 M PB (pH 7.0) on GQDs/IL-SPCE at various pulse potential in the range of 0.01 to 0.1 V. .... 31



- Figure A4** DPV responses of a mixture of 0.5 mM carbofuran-phenol (CAF-phenol) and 0.5 mM carbendazim-phenol (CAD-phenol) in 0.1 M PB (pH 7.0) on GQDs/IL-SPCE at various step potential in the range of 0.0002 to 0.023 V. .... 31
- Figure A5** DPV responses of a mixture of 0.5 mM carbofuran-phenol (CAF-phenol) and 0.5 mM carbendazim-phenol (CAD-phenol) in 0.1 M PB (pH 7.0) on GQDs/IL-SPCE at various pulse time in the range of 0.005 to 0.03 s. .... 32
- Figure A6** DPV responses of a mixture of 0.5 mM carbofuran-phenol (CAF-phenol) and 0.5 mM carbendazim-phenol (CAD-phenol) in 0.1 M PB (pH 7.0) on GQDs/IL-SPCE at various scan rate in the range of 0.01 to 0.125 V/s. .... 32

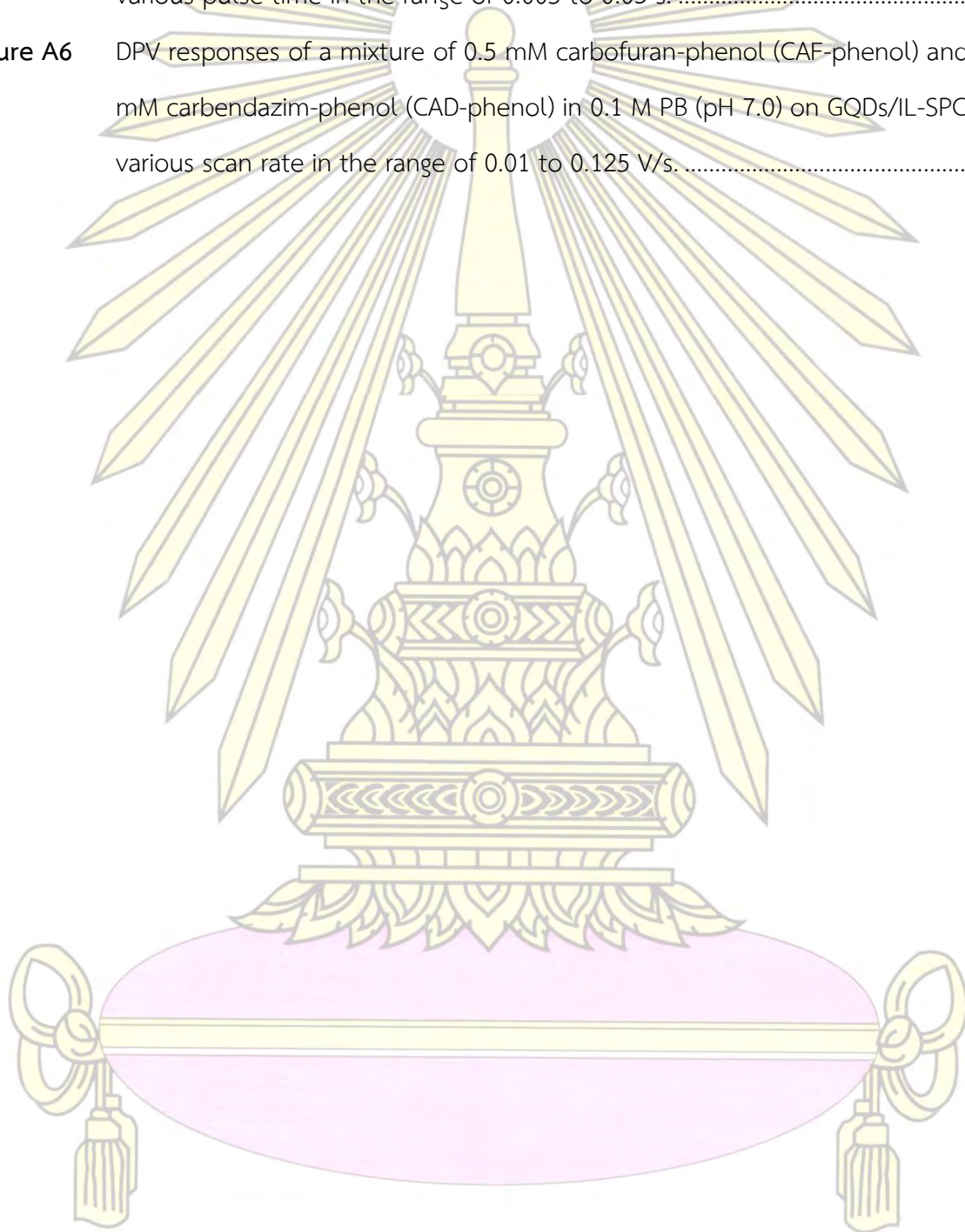

## LIST OF ABBREVIATION

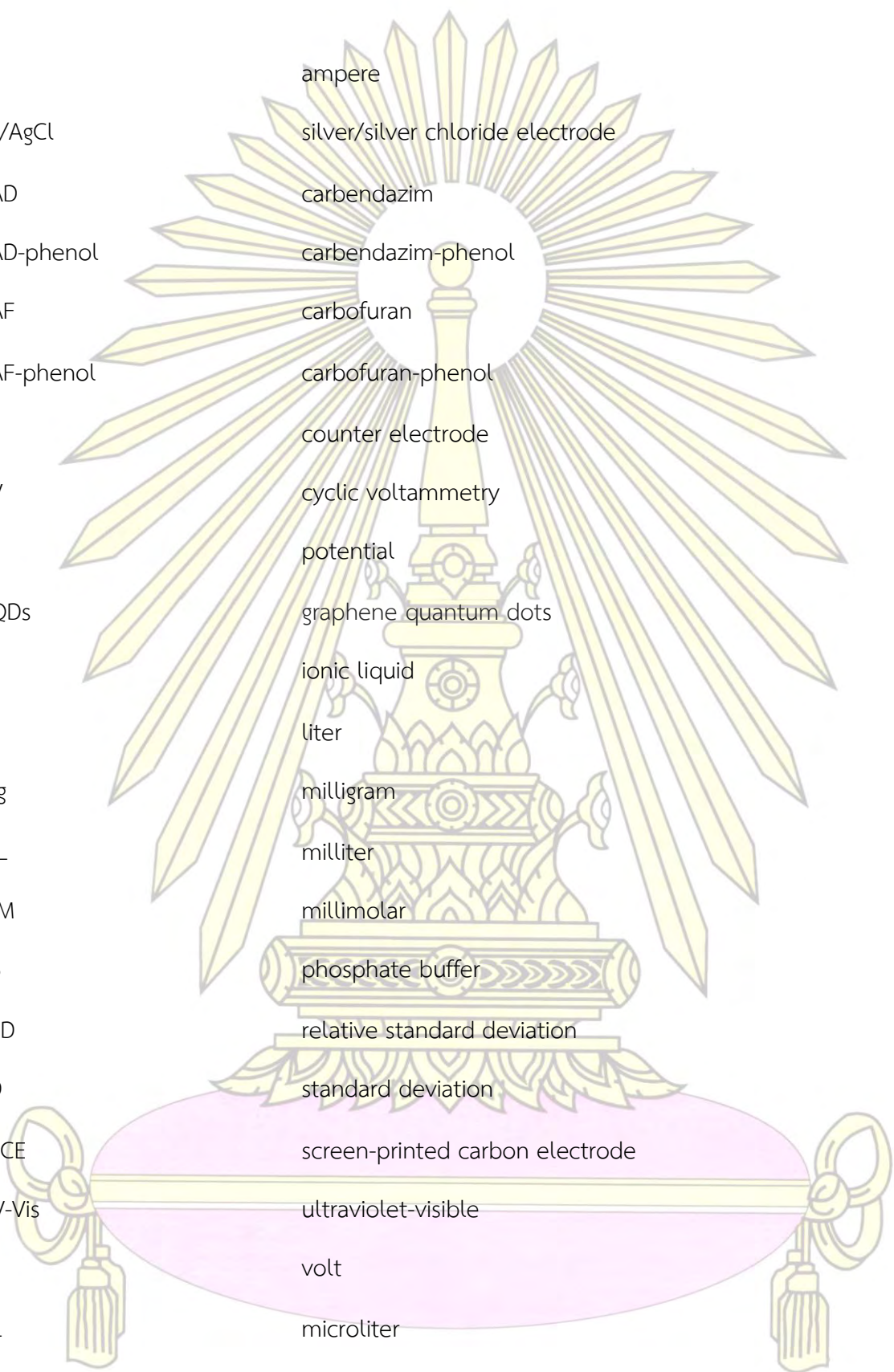

A	ampere
Ag/AgCl	silver/silver chloride electrode
CAD	carbendazim
CAD-phenol	carbendazim-phenol
CAF	carbofuran
CAF-phenol	carbofuran-phenol
CE	counter electrode
CV	cyclic voltammetry
E	potential
GQDs	graphene quantum dots
IL	ionic liquid
L	liter
mg	milligram
mL	milliliter
mM	millimolar
PB	phosphate buffer
RSD	relative standard deviation
SD	standard deviation
SPCE	screen-printed carbon electrode
UV-Vis	ultraviolet-visible
V	volt
$\mu$ L	microliter



# CHAPTER I

## INTRODUCTION

### 1.1 Introduction

Thailand is one of agricultural countries where various kinds of agricultural products are abundantly produced for both domestic consumption and exporting. Unavoidably, pesticides are used to decrease the damaged products and increase the efficiency of the production. Carbofuran (CAF) is one of pesticides in carbamate group which is also well known as Furadan or Curater. Mostly, CAF is used in control insects in a wide variety of field crop, rice, carrot, potato, et cetera by placing CAF on the bottom of hole before planting. CAF will be absorbed via root and then distribute throughout its organs where the accumulation takes place [1]. If human takes CAF-contaminated food, it will inhibit enzyme acetylcholinesterase (AChE); as a result, it could lead the symptoms queasiness, vomiting, stomachache, diarrhea, and difficulty in breathing or death. Moreover, the toxicity of CAF can cause the abnormality in genes, sex cell (gamete) and fetal [2, 3]. Consequently, CAF was banished in production, importing, trading, including contaminated product in many regions such as USA and EU. However, CAF is still widely uses in Thailand. Without the awareness of the danger of the toxicity, some of the peasants are careless to follow the instructions; resulting in overusing and remaining of CAF in plant.

In the present day, the determination of CAF is mostly done by Gas Chromatography (GC), High Performance Liquid Chromatography (HPLC), Capillary Electrophoresis (CE) and Mass Spectrometry (MS) [4]. These techniques are sensitive and standard methods for CAF determination; nevertheless, they also have disadvantages due to time consumption, complexity of instruments, very high cost in instruments and maintenance and highly trained personnel as well. Therefore, electrochemical technique has become interesting due to their high sensitivity, short-time analysis, portability, and using a very little amount of sample in analysis.

Voltammetry is one of electrochemical techniques using the relationship of potential and current by providing potential into the circuit to force the occurring of chemical reaction and measuring the current during the reaction by using microelectrode to reduce the effect of concentration polarization. The researcher is interested in using screen-printed carbon



electrode due to homemadable electrode, disposability and very low cost. However, the ability in conduction of carbon is not as good as metals like mercury or silver; consequently, the sensitivity of electrode made of carbon are more inferior to those made of mercury or silver. Therefore, GQDs have become of great interest due to the property of being semiconductor.

Graphene quantum dots (GQDs) are 0D material which contain functional groups—carboxyl, carbonyl, hydroxyl—on their edges where the reaction takes place; as a result, GQDs obtain the properties of high conduction and luminescent stability. Moreover, they are non-toxicity and chemical stability [5, 6]. From the excellent attributes, using GQDs in modified electrode will enhance the sensitivity in the measurement.

In this research, in summary, researcher is interested in determination of CAF using GQDs modified SPCE by voltammetric technique.

## 1.2 Literature Review

In 2003, Jan *et al.* [7] reported the use of indirect spectrophotometric method for determination of CAF by detecting methylamine, instead of directly detect CAF, which was one of the products from hydrolysis of CAF with 100 mL of 1% sodium nitroprusside solution in acetone medium resulting in the two products, which the other product is 2,3-dihydro-2,2-dimethylbenzofuran-7-ol (carbofuran-phenol). The limit of detection and limit of quantification at the optimized condition are 0.804 and 2.68 ppm, respectively.

In 2011, Chang *et al.* [8] reported that SPCE modified with 1-butyl-3-methylimidazolium hexafluorophosphate ([BMIM][PF<sub>6</sub>]) as ionic liquid was able to enhance the sensitivity and selectivity for the detection of dopamine in the presence of highly concentrated ascorbic acid. [BMIM][PF<sub>6</sub>] was reported to improve sensitivity, linearity and selectivity in carbon paste electrode.

In 2012, Dong *et al.* [6] reported the easy method to synthesize GQDs via bottom up method by carbonizing citric acid through pyrolysis and applying high temperature in order to decomposition. GQDs was synthesized by melting 2 g citric acid from colorless until orange and then quickly added drop by drop into 100 mL of 10 mg mL<sup>-1</sup> sodium hydroxide and neutralizing it to pH 7.0 before used. The obtained GQDs will be nanosheets with width around 15 nm and thickness around 0.5-2.0 nm.

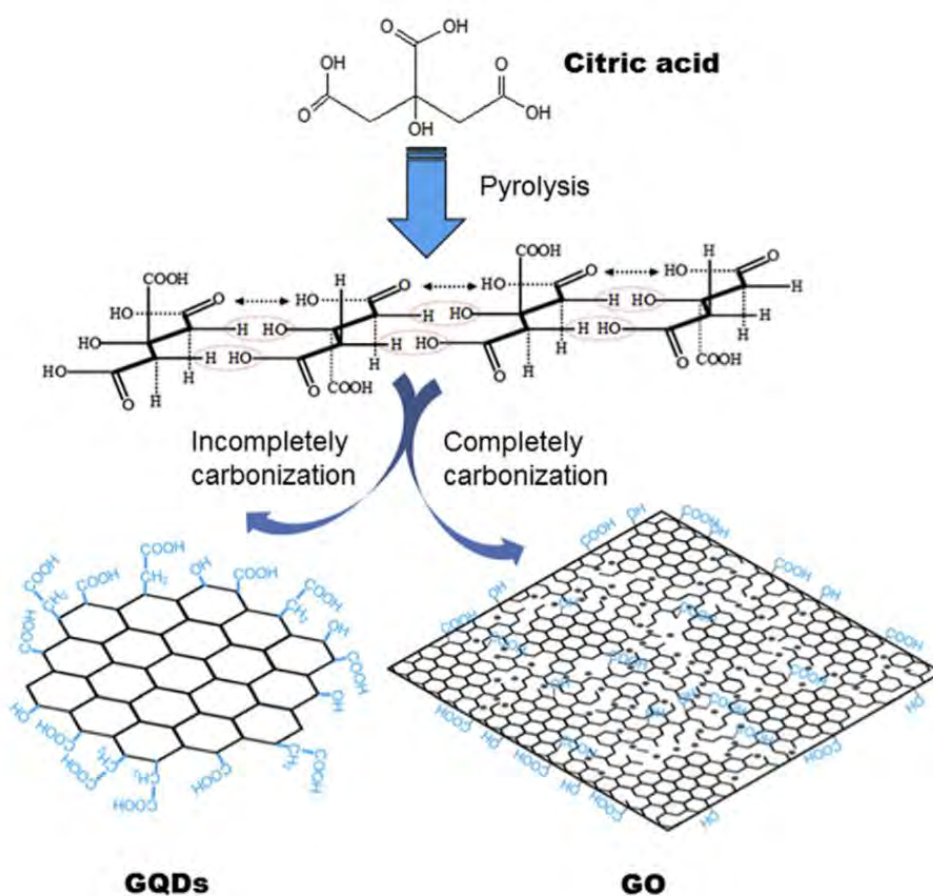

**Figure 1.1** Scheme of the synthesis of graphene quantum dots (GQDs) and graphene oxide (GO) [6].

In 2014, Wong *et al.* [4] developed modified electrode with hemin complex and graphene oxide for the determination of CAF in food by square wave voltammetry (SWV) with very low concentration of detection limit, high selectivity because of hemin, and high sensitivity due to graphene oxide. Moreover, this proposed method can be compared with HPLC method of detection due to the obtained results were similar.

### 1.3 Theory

#### 1.3.1 Carbofuran

Carbofuran (CAF) is one of toxic carbamate pesticides. The structure based on N-substituted carbamic acid esters ( $R_1\text{OCONHR}_2\text{R}_3$ ), where  $R_1$  is heterocyclic aromatic ring,  $R_2$  is methyl group, and  $R_3$  is a hydrogen (Fig. 1.2). Its physical properties are described in following Table 1.1.



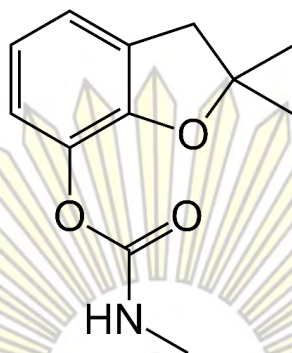

**Figure 1.2** Structure of carbofuran.

**Table 1.1** The physiochemical properties of carbofuran (CAF)

IUPAC name	2,2-Dimethyl-2,3-dihydro-1-benzofuran-7-yl methylcarbamate
Common name	Furadan, Curater
Chemical formula	$C_{12}H_{15}NO_3$
Molecular mass	221.26 g/mol
Density	1.18 g/mL
Melting point	151°C
Boiling point	313°C
Solubility in water	320 mg/L
Solubility	Highly soluble in N-methyl-2-pyrrolidone methanol, acetone etc.

The ample amount of CAF in agricultural products can cause severe illnesses and abnormality in genes and fetal. However, in Thailand, CAF is extensively used to protect the plants from pests. Not only affect to domestic people health but also affect to the exportation of agricultural products including reliability and image of the country as well. For these reasons, the determination of CAF becomes a greatly significance. According to earlier research [9, 10] that CAF has very low response in electrochemical activity, so the hydrolysis of CAF become an essential part of electrochemical determination which CAF was hydrolyzed into the phenol form (Fig. 1.3) which showed more obvious electrochemical response.



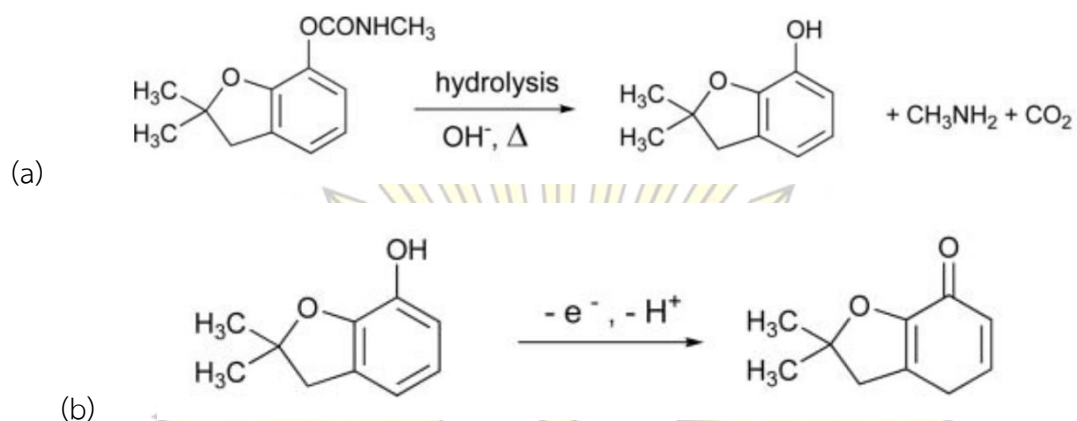

**Figure 1.3** Scheme of (a) hydrolysis of carbofuran (CAF) to form carbofuran-phenol and (b) oxidation of carbofuran-phenol [11].

### 1.3.2 Electrochemical technique

The electrochemical technique is one of the analytical techniques study about electrochemical response of analyte in electrical stimulated system. Generally, losing (oxidation) and receiving (reduction) electrons, which are called redox reaction, play an important role in the system. Normally, every substance provides the specific electrochemical information. This reason make electrochemical technique has many advantages such as high selectivity, high sensitivity, and low expense; moreover, many analytes in one solution are allowed for this technique. Electrochemical techniques can be classified into potentiometry, voltammetry, coulometry and electrogravimetry by method of determination and the output information (Table 1.2). Significantly, the use of electrochemical methods are dependent on the characteristic of analyte, quantity of sample and analyte environment.

**Table 1.2** Methods of electrochemical technique

Methods	Input to system	Measurement
Potentiometry	current = 0	potential
Voltammetry	potential	current
Coulometry	potential or current	amount of electric charge
Electrogravimetry	potential or current	mass of analyte

### 1.3.2.1 Voltammetry

Commonly, voltammetry referred to a group of electrochemical technique which study the relationship between provided potential and current signal under concentration polarization condition which occur close to the electrode surface. In order to generate polarization, the electrode surface must be very small in size (microelectrode) and the external potential must be necessary (electrolytic cell). In addition, the determination of the sample will be plotted in the relationship of measured current and applied potential which is so-called voltammogram. There are many sub-techniques in voltammetry which were categorized by the potential waveforms applied as a function of time (Fig. 1.4); nevertheless, in this project, cyclic voltammetry and differential pulse voltammetry were chosen for development of determination method of CAF. They will be explained in the following sections.

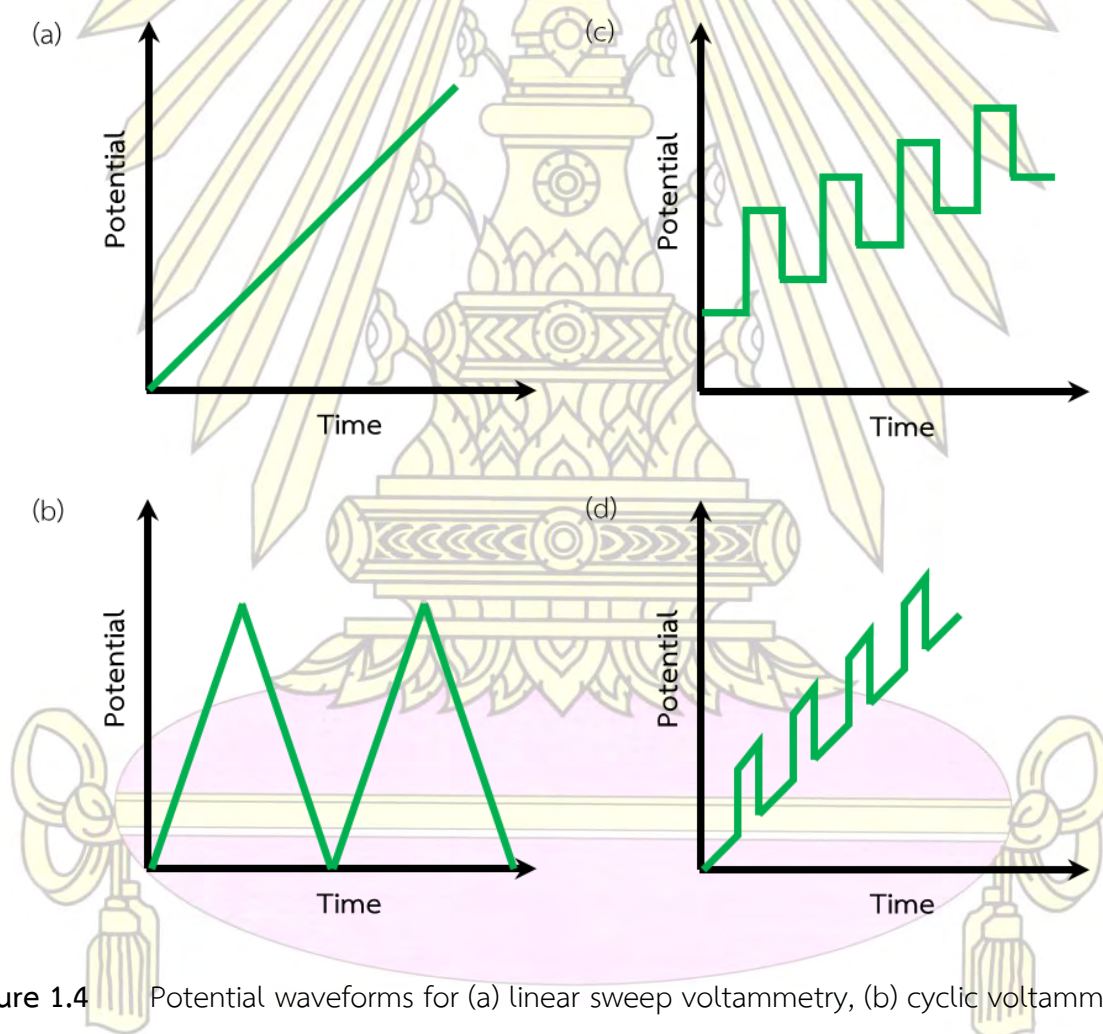

**Figure 1.4** Potential waveforms for (a) linear sweep voltammetry, (b) cyclic voltammetry, (c) square-wave voltammetry and (d) differential pulse voltammetry.



## Cyclic voltammetry

Cyclic voltammetry or CV is a common electrochemical technique which studies about redox processes, reaction intermediates, reaction products and electrochemical behavior of electroactive species; however, this method is unsuitable technique for quantitative analysis. In CV performance, the potential was provided and scanned linearly at working electrode in both forward and reverse direction (Fig. 1.5) while current is observed. The initial potential may be started at either negative or positive direction and could reversely run in the opposite direction depending on analyte.

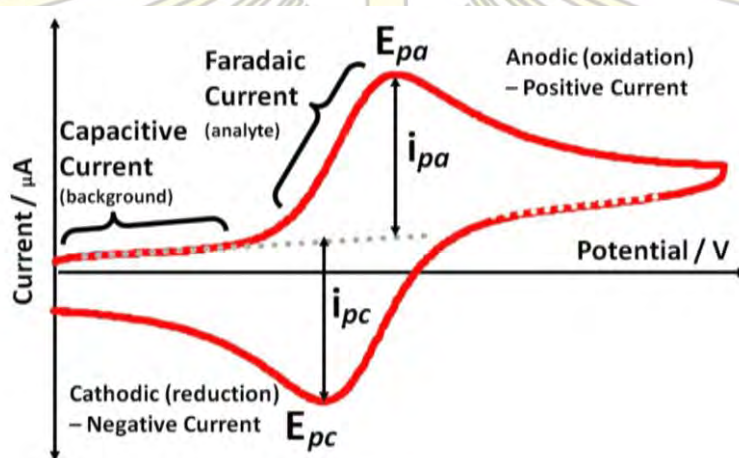

Figure 1.5 Traditional cyclic voltammogram of reversible redox system.

From cyclic voltammogram, when the positively applied potential reach the highest point, it is called anodic peak potential ( $E_{pa}$ ) and the anodic current ( $i_{pa}$ ) will be observed. In the opposite direction scan, negatively, the cathodic current ( $i_{pc}$ ) will be observed when reaching cathodic peak potential ( $E_{pc}$ ).

## Differential pulse voltammetry

This technique is a part of pulse voltammetry which differs from normal pulse method in term of applying pulse potential. In normal pulse method, the potential pulses were applied to the electrolytic system and were measured at every end of each pulse. Differently, in differential pulse method, the potential pulses were steadily increased to electrode in form of linear scan (Fig. 1.4). Nevertheless, the measurement is still considered as same as normal pulse method.



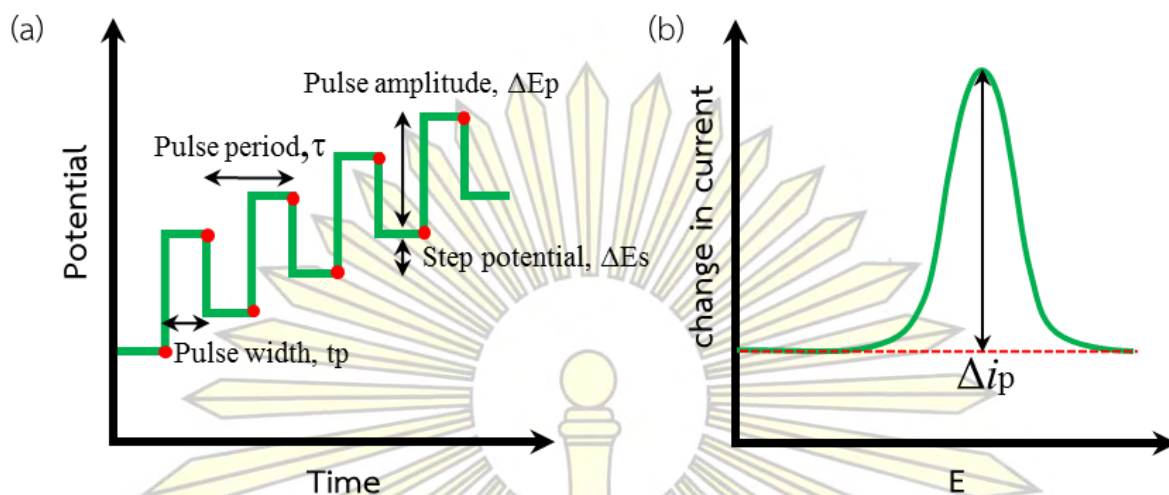

Figure 1.6 (a) Waveform and (b) differential pulse voltammogram.

### 1.3.2.2 Electrode

In voltammetry experiment, three-electrode system—which consisting of reference electrode (RE), working electrode (WE) and counter electrode (CE)—is normally used in performance. Sample solution not only contains the analyte but also constitutes, supporting electrolyte which won't affect the reaction. When time-dependent potential is applied relatively reference electrode to the solution system, the current was generated by the flow of electroactive species between counter electrode and working electrode.

#### Screen-printed carbon electrode

Screen-printed carbon electrode or SPCE is extensively using as electrochemical sensor [12] due to its very low cost, simple fabrication, high conductivity, chemical stability, wide potential window and suitability for various detections. Commonly, SPCE is made of inert materials which will be fabricated by screen-printing methodology in small size. For reference electrode, Ag/AgCl is mostly used as pseudo RE and connected to carbon at the conductive tracks. For carbon, there are various forms of carbon; for examples, carbon paste, graphene and carbon nanotube, are well known as inert materials. In this project, carbon ink is chosen in fabrication of SPCE along with silver paste as RE. Moreover, graphene quantum dots (GQDs) and ionic liquid (IL) were used in the fabrication in order to increase sensitivity of SPCE.

Counter electrode ←  
 Reference electrode ←  
 Working electrode ←

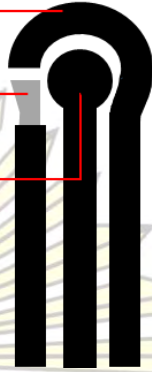

Figure 1.7 Screen printed carbon electrode.

### 1.3.2.3 Modifying materials

#### Graphene Quantum Dots

Graphene quantum dots or GQDs are very small pieces of graphene sheets with less than 100 nm in lateral size and 10 nm in thickness. Usually, they have functional groups--carboxyl, epoxy, carbonyl, epoxied--at their edges where the reaction sites are taken place; hence, GQDs have remarkable attributes which are quantum confinement and edge effect that make GQDs have good conductivity, photoelectric property and being semiconductor. Moreover, GQDs presented low toxicity, photobleaching property, stable luminescence, inexpensive materials, chemical stability and excellent biocompatibility.

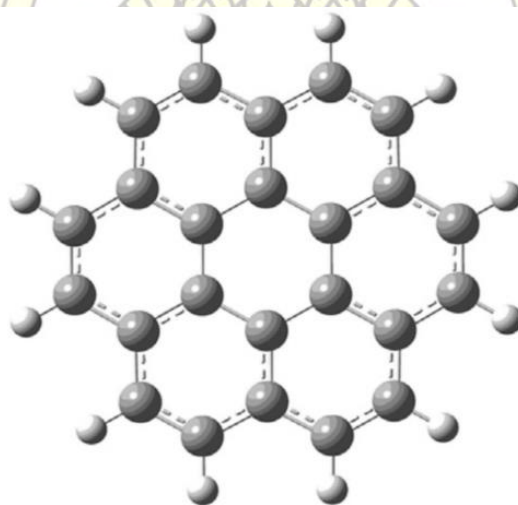

Figure 1.8 Typical structure of a layer of a graphene quantum dots [13].



## Ionic liquid

Ionic liquid (IL) is ionic salt compound which has melting point under 100°C [14]. Normally in ionic compound, a cation and an anion interact by ionic bond; unlike ionic liquid (IL), a large and unsymmetrical organic cation and an organic or an inorganic anion interact by coulomb interaction. Consequently, IL contains unique properties which are wide electrochemical potential window, good solvent for a whole range of inorganic and organic materials, have very low vapor pressure at room temperature, high thermal resistant ability and are environmental friendly material as well [15]. Due to its properties, IL received an interested in enhance the sensitivity of SPCE for CAF determination.

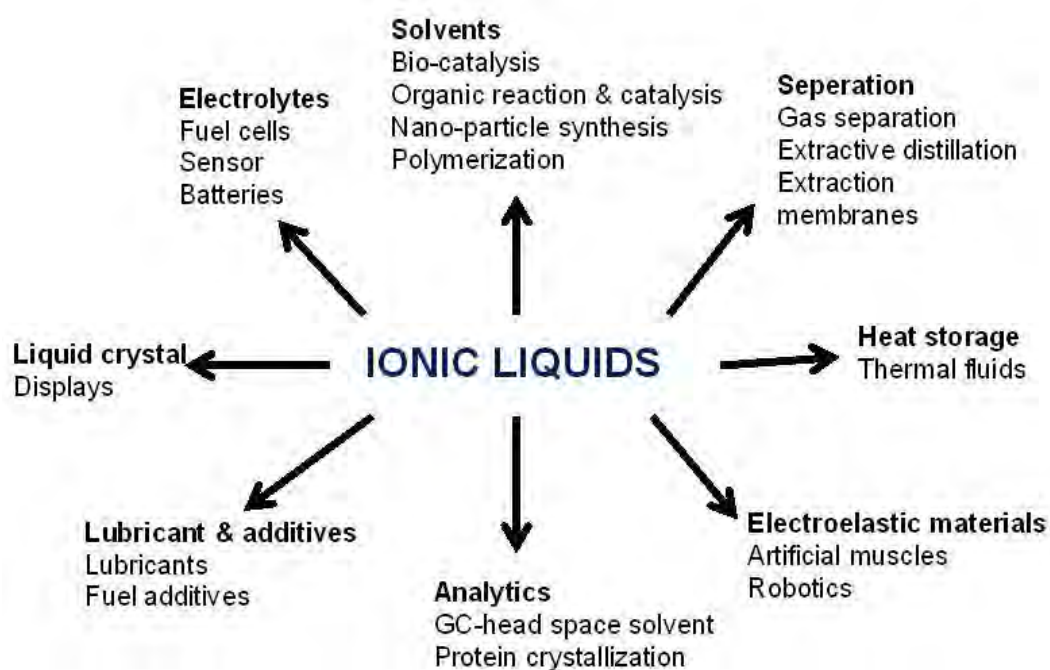

Figure 1.9 Various applications of ionic liquid [16].

### 1.4 Objectives

This research contains two main goals as followed:

- 1) To develop a new method for CAF determination by voltammetry using screen printed carbon electrode modified with graphene quantum dots-modified (SPCE) and ionic liquid (IL).
- 2) To apply the new method for determination of CAF in real sample



## CHAPTER II

### EXPERIMENTAL

#### 2.1 Instruments and apparatus

##### 2.1.1 Synthesis of QDs

The instruments and apparatus used for the synthesis of QDs are shown in the Table 2.1.

**Table 2.1** List of instruments and apparatus using in synthesis of QDs

Instruments and apparatus	Suppliers
Hot plate stirrer, HL HS-115	Harikul Science, Thailand
Glassware	

##### 2.1.2 Characterization of the synthesized QDs

The instruments and apparatus using in characterization of the synthesized QDs are listed in Table 2.2.

**Table 2.2** List of instruments and apparatus using in characterization of the synthesized QDs

Instruments and apparatus	Suppliers
UV-Visible spectrophotometer	Agilent, USA
Cary Eclipse Fluorescence spectrophotometer	Agilent, USA
Quartz cuvette	

##### 2.1.3 Hydrolysis of CAF-phenol and CAD-phenol

Hydrolysis of CAF-phenol and CAD-phenol requires instruments and apparatus shown in Table 2.3.

**Table 2.3** List of instruments and apparatus used in preparation of sample solution

Instruments and apparatus	Suppliers
pH meter	Metrohm, Switzerland
Micropipette and tips	Eppendorf, Germany
Hot plate stirrer, HL HS-115	Harikul Science, Thailand
Universal indicator test paper, pH 14	Merck, Germany
Glassware	

#### 2.1.4 Fabrication of the GQDs/IL-SPCE

The instruments and apparatus involved in fabrication of GQDs/IL-SPCE are listed in Table 2.4.

**Table 2.4** List of instruments and apparatus used in fabrication of GQDs/IL-SPCE

Instruments and apparatus	Suppliers
Screen-printed blocks	Chaiyaboon, Thailand
Hot air oven	Memmert, USA
Glassware	

## 2.2 Chemicals

### 2.2.1 Synthesis of GQDs

The chemicals used in synthesis of GQDs are shown in Table 2.5.

**Table 2.5** List of chemicals using in synthesis of GQDs

Chemicals	Suppliers
Citric acid monohydrate (AR grade)	Carlo Erba, USA
Sodium hydroxide (AR grade)	Sigma-Aldrich, Germany
Milli-Q ultrapure water	Milli-Q ultrapure water purification system, Millipore, USA



## 2.2.2 Hydrolysis of CAF-phenol and CAD-phenol

Hydrolysis of CAF-phenol and CAD-phenol needed the chemicals shown in Table 2.6.

**Table 2.6** List of chemicals used in preparation of sample solution

Chemicals	Suppliers
Milli-Q ultrapure water	Milli-Q ultrapure water purification system, Millipore, USA
Sodium hydroxide (AR grade)	Sigma-Aldrich, Germany
Potassium phosphate monobasic (AR grade)	Sigma-Aldrich, Germany
Potassium phosphate dibasic (AR grade)	Sigma-Aldrich, Germany
Carbofuran (AR grade)	Sigma Chemical, Australia
Carbendazim (HPLC grade)	Fluka, Germany

## 2.2.3 Fabrication of the GQDs/IL-SPCE

The chemicals used in fabrication of the GQDs/IL-SPCE are listed in Table 2.7.

**Table 2.7** List of chemicals using in fabrication of the GQDs/IL-SPCE

Chemicals	Suppliers
1-butyl-3-methylimidazolium hexafluorophosphate (AR grade)	Sigma-Aldrich, Germany
Carbon ink (product code: C2030519P4, diluent: thinner)	Gwent, UK
Silver/silver chloride ink	Gwent, UK

## 2.3 Chemical preparation

### 2.3.1 Preparation of solution for GQDs synthesis

#### 2.3.1.1 Sodium hydroxide solution, 10 mg/mL

Dissolving 0.1 g of sodium hydroxide in 100 mL of Milli-Q water then 10 mg/mL of sodium hydroxide solution was prepared.



### **2.3.1.2 Citric acid solution, 1 mg/mL**

Dissolving 0.1 g of citric acid in 100 mL of Milli-Q water then 1 mg/mL of citric acid solution was prepared.

## **2.3.2 Phosphate buffer solution (PB), 0.1 M**

### **2.3.2.1 Potassium phosphate monobasic solution, 0.1 M**

A 0.1 M potassium phosphate monobasic solution was prepared by dissolving 1.38 g of potassium phosphate monobasic in 100 mL of Milli-Q water.

### **2.3.2.2 Potassium phosphate dibasic solution, 0.1 M**

A 0.1 M potassium phosphate dibasic solution was prepared by dissolving 1.42 g of potassium phosphate dibasic in 100 mL of Milli-Q water.

### **2.3.2.3 Phosphate buffer solution (PB), 0.1 M**

A 0.1 M PBS pH 7.0 was prepared by mixing the stock solution of 0.1 M potassium phosphate monobasic and 0.1 M potassium phosphate dibasic in ratio of 58.7 : 41.3 mL respectively.

## **2.3.3 Hydrolysis of CAF-phenol and CAD-phenol**

### **2.3.3.1 Sodium hydroxide solution, 0.1 M**

Dissolving 0.1 g of sodium hydroxide in 25 mL of Milli-Q water then 0.1 M of sodium hydroxide solution was prepared.

### **2.3.3.2 Carbofuran-phenol, 5 mM**

Carbofuran-phenol was prepared by dissolving 4.42 mg of carbofuran in 25 mL of 0.1 M of sodium hydroxide. Next, the carbofuran solution was heated at 70°C for 1 hour. After that, 10 mM of carbofuran-phenol was obtained and cooled down to room temperature. Finally, 12.5 mL of 10 mM carbofuran-phenol was adjusted to 25 mL with 0.1 M PB (pH 7.0) in volumetric flask and then 25 mL of 5 mM carbofuran-phenol was prepared.

### 2.3.3.3 Carbendazim-phenol, 5 mM

Carbendazim-phenol was prepared as same step as carbofuran-phenol preparation by using 3.79 mg of carbendazim in the initial step.

## 2.4 Synthesis of QDs

The QDs were synthesized by pyrolysis of citric acid [6]. According to the previous study, 2 g of citric acid was heated at 200°C for 5 minutes to transform the colorless solid state to colorless liquid state. After that, the liquid was changed in color to orange after heating for 30 minutes. Then, the orange liquid was drop into 100 mL of 10 mg/mL sodium hydroxide. Finally, the aqueous solution of QDs was adjusted to pH 7.0 using citric acid solution and then stored in 4°C refrigerator.

## 2.5 Characterization of QDs

The illustration of QDs solution was taken by smartphone. The UV-Visible spectrum of QDs was acquired by the UV-Visible spectrophotometer using 1.0 cm quartz cell. The fluorescence spectrum of QDs was obtained by fluorescence spectrophotometer with excitation at 365 nm in wavelength.

## 2.6 Fabrication of the QDs/IL-SPCE

The SPCE can be prepared by cleaning up the electrode templates with acetone follow by ethanol and PVC sheet, which was cut in size of 12 × 14 cm, with ethanol only. Firstly, the screen-printing was performed on PVC sheet to form reference electrode silver/silver chloride (Ag/AgCl) then air drying for 1 hour in an oven which set the temperature to 55°C. Next, the mixtures of 1 g carbon ink and 10 mg 1-butyl-3-methylimidazolium hexafluorophosphate ([BMIM][PF<sub>6</sub>]), IL, were prepared and screen-printed on the PVC sheet with dried silver/silver to form WE and CE. Then, it was dried in 55°C oven for 1 hour. After that, 7.5 μL of QDs was modified on the surface of WE by drop casting 2.5 μL of QDs for 3 times. Finally, the modified electrode was obtained and stored in a desiccator.



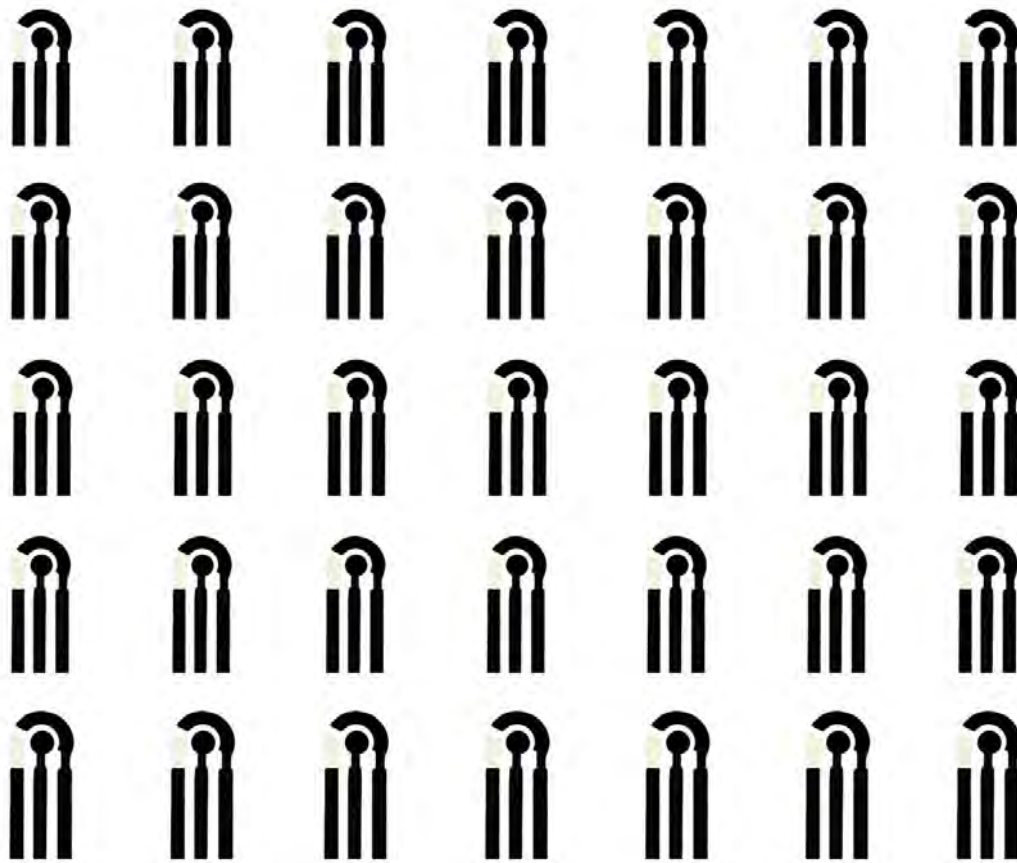

**Figure 2.1** The illustration of the 35 screen-printed carbon electrodes on a 12 cm x 14 cm PVC sheet.

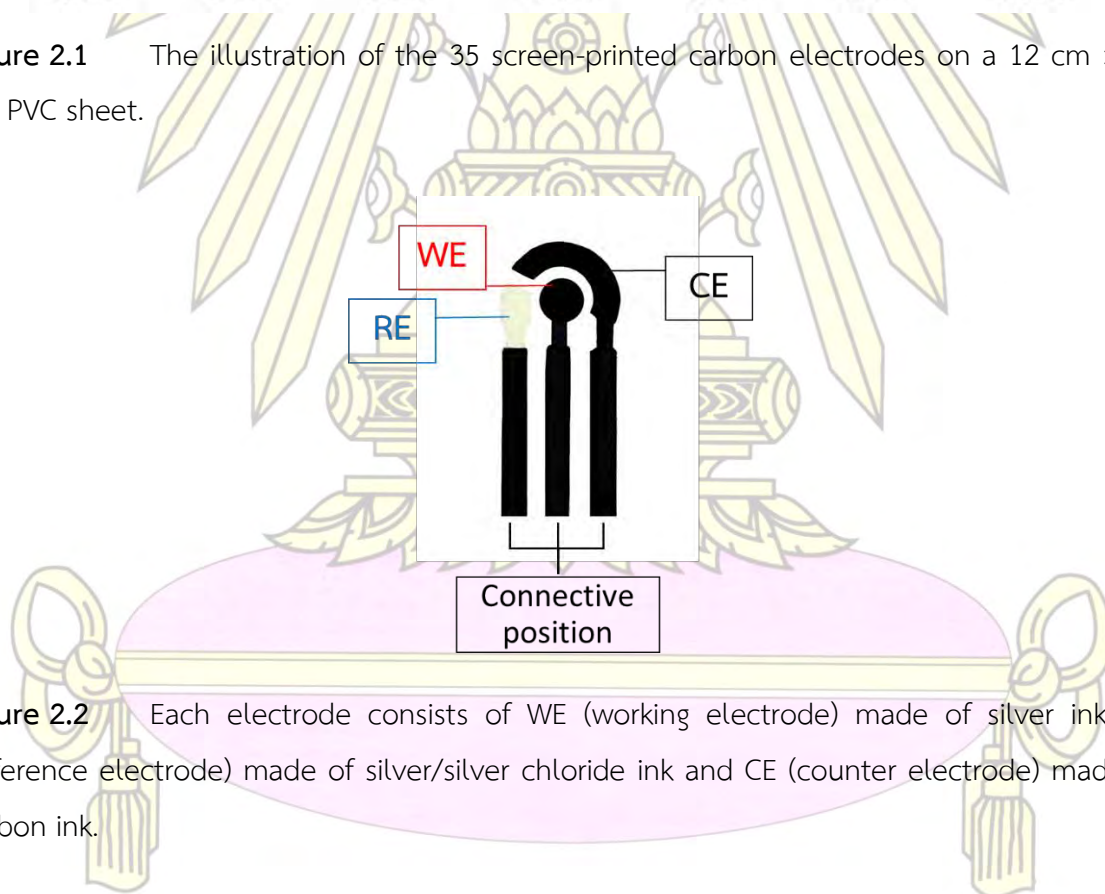

**Figure 2.2** Each electrode consists of WE (working electrode) made of silver ink, RE (reference electrode) made of silver/silver chloride ink and CE (counter electrode) made of carbon ink.

## 2.7 Electrochemical measurements

The electrochemical measurements were operated by using PalmSen3 Potentiostat and controlled by PSTrace 4.7 software. The experiment procedure was explained on the following.

### 2.7.1 Cyclic voltammetry

The cyclic voltammetry (CV) measurement was performed by applying 60  $\mu\text{L}$  of 0.1 M PB solution pH 7.0 on the modified electrode as background current. After that, 60  $\mu\text{L}$  of the analyte in buffer solution was dropped on the same electrode. The electrode was changed to the new one every essay.

### 2.7.2 Differential pulse voltammetry

The differential pulse voltammetry was performed as describe on the following procedure. Firstly, the modified electrode was pretreated by dropping 60  $\mu\text{L}$  of 0.1 M PB solution pH 7.0 and applying potential of 2.0 V vs silver/silver chloride electrode for 120 s. After that, 60  $\mu\text{L}$  of 0.1 M PB solution pH 7.0 was dropped on the surface of electrode as background current. Finally, 60  $\mu\text{L}$  of the analyte in solution was dropped on the pretreated electrode. Every essay uses new electrode.

## 2.8 Optimization of modified electrode

### 2.8.1 The amount of IL

The effect of the amount of IL on electrochemical response of CAF-phenol at GQDs/IL-SPCE was studied by cyclic voltammetry using the electrode screen-printed with the mixture of 1 g carbon ink and various amount of IL which are 0, 5, 10, 15 and 20 mg.

### 2.8.2 The volume of GQDs

The effect of the volume of GQDs on CV response of CAF-phenol was investigated by variation of the GQDs solution volume at 0, 2.5, 5.0, 7.5 and 10.0  $\mu\text{L}$ .



## 2.9 Optimization of the DPV parameter

### 2.9.1 The effect of pulse potential

The influence of pulse potential on the DPV response of CAF-phenol was studied by variation of pulse potential between 0.01 to 0.1 V.

### 2.9.2 The effect of step potential

The influence of pulse potential on the DPV peak current was studied by variation of pulse potential between 0.002 to 0.023 V.

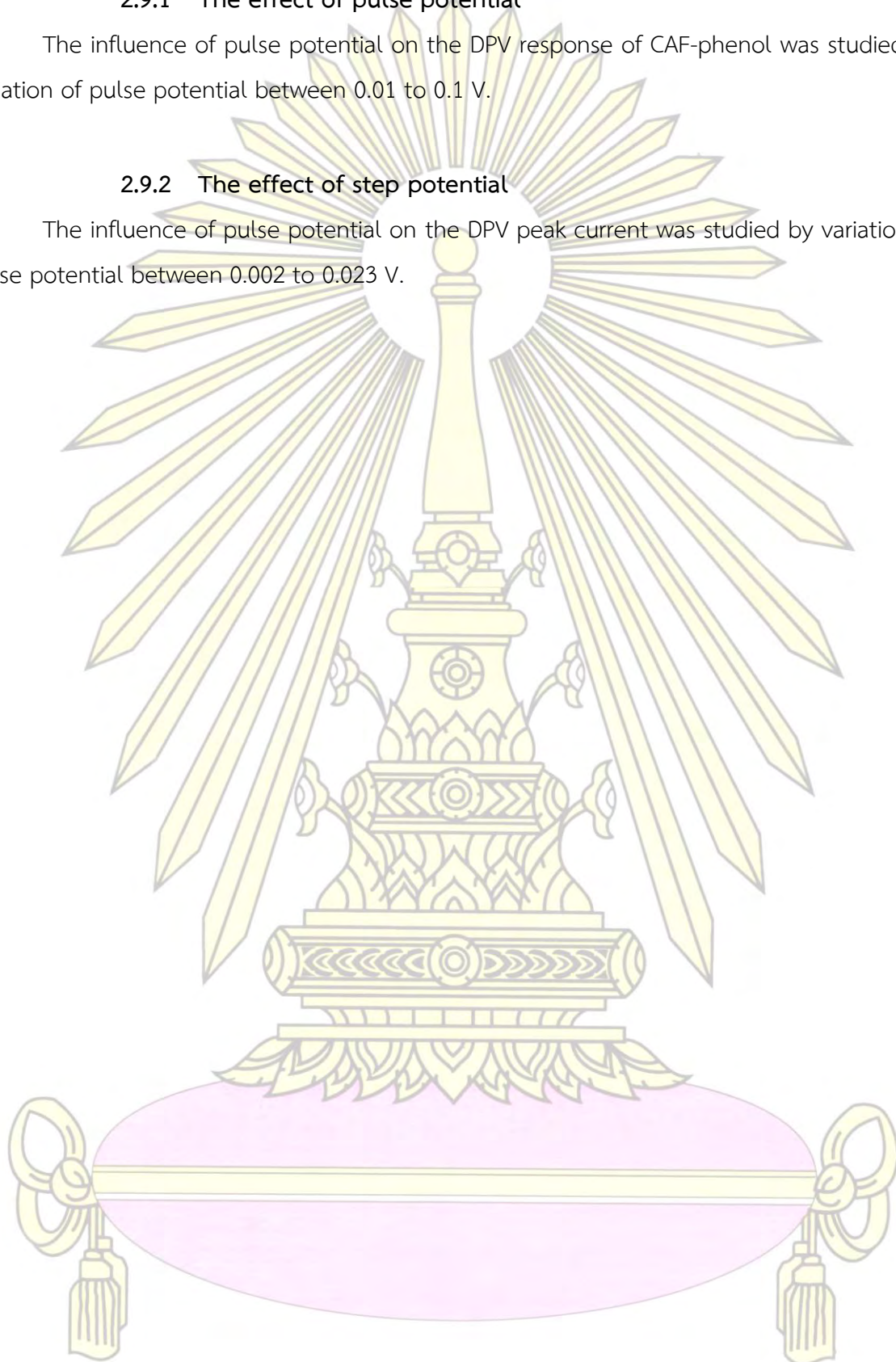

## CHAPTER III

### RESULTS AND DISCUSSION

This chapter consists of results and discussion of characterizations of synthesized QGDs, optimization of modified electrodes, calibration curve of CAF-phenol and the optimization of the DPV parameters which are pulse potential, step potential, pulse time and scan rate.

#### 3.1 Characterization of synthesized QGDs

The QGDs solution was easily synthesized via pyrolysis of citric acid. The appearance is clear and colorless aqueous solution but turn to blue color (Fig. 3.1) under the excitation of 365 nm by black light.



**Figure 3.1** Photographs of the QGDs solution which were taken by smartphone under visible light (left) and under black light (right).

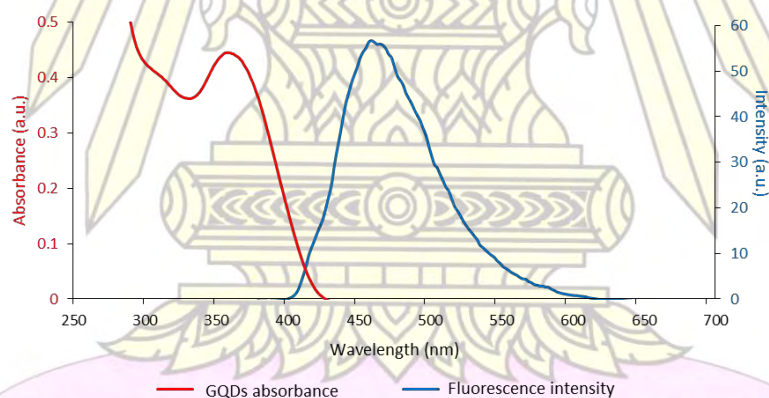

**Figure 3.2** UV-Vis absorption (red line) and fluorescence spectra (blue line) of synthesized QGDs.

From absorption spectrum of QGDs in Fig. 3.2, the absorption region of below 300 nm was assigned to the  $\pi-\pi^*$  transition of aromatic  $sp^2$  domains which referred to C=C. The absorption peak at  $\sim 365$  nm was assigned to the  $n-\pi^*$  transition peak which referred to C=O.



When GQDs solution was excited at  $\sim 365$  nm, the maximum emission was observed at  $\sim 460$  nm which correspond to the fluorescence spectra in Fig. 3.2 [17].

### 3.2 Optimization of modified electrode

#### 3.2.1 The amount of IL

The effect of amount of IL on the electrochemical responses was studied by mixing 0, 5, 10, 15 and 20 mg of IL with 1 g carbon ink, which are 0, 0.5, 1.0, 1.5 and 2.0% wt/wt, respectively.

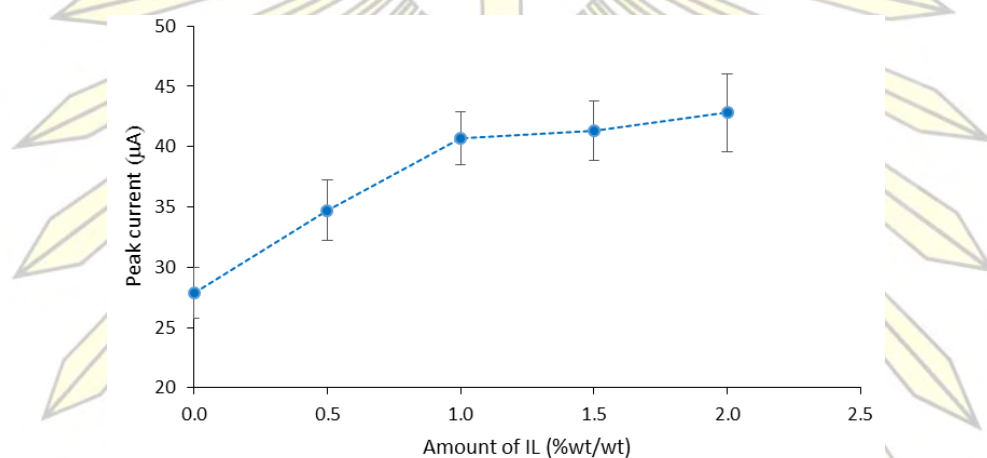
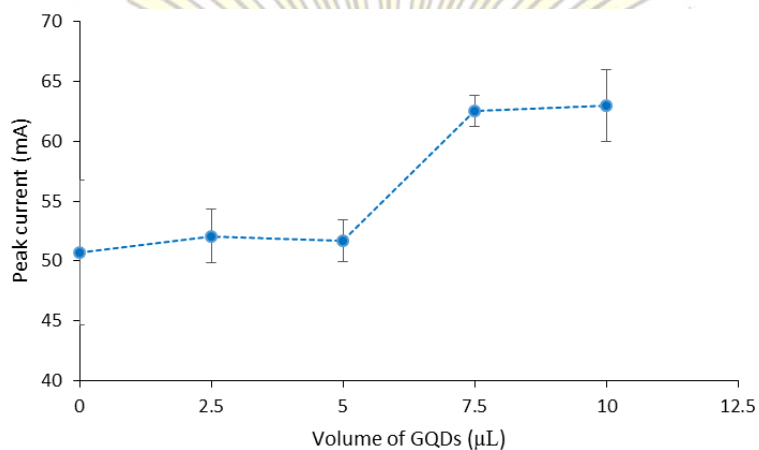

**Figure 3.3** Effect of the amount of IL on the peak current of 3 mM carbofuran-phenol (CAF-phenol) in 0.1 M PB (pH 7.0) on GQDs/IL-SPCE prepared from the mixture of 0, 5, 10, 15, and 20 mg IL with 1 g of carbon ink and 7.5  $\mu\text{L}$  GQDs.

From Fig. 3.3, the anodic peak current of CAF-phenol was linearly dramatically increased with increasing percentage of IL from 0% wt/wt to 1.0% wt/wt. This can be explained that increasing amount of IL enhanced the amount of CAF-phenol accumulated on the electrode surface due to the ability of IL to dissolve a wide range of compounds and improved the sensitivity of the electrode as well. Then, from 1.0 to 1.5% wt/wt of IL, the anodic peak currents still remained and slightly increased again at 2.0% wt/wt. This is because the amount of CAF-phenol dissolved in excess amount of IL was limited due to the fixed concentration of CAF-phenol. Even though, the highest anodic peak current was obtained at 2.0% wt/wt, the error bar at 2.0% wt/wt was the widest. Moreover, there is no observable difference in peak current between 1.0% wt/wt and 1.5% wt/wt. Hence, the optimal amount of IL was 1.0% wt/wt and this amount were used in the following experiments.

### 3.2.2 The volume of GQDs

The effect of volume of GQDs solution on the cyclic voltammetry of CAF-phenol was studied at 0, 2.5, 5.0, 7.5 and 10.0  $\mu\text{L}$  which are the variation of GQDs volume modified on WE surface by drop casting.



**Figure 3.4** Plot of anodic peak currents of 3 mM carbofuran-phenol in 0.1 M PB (pH 7.0) on GQDs/IL-SPCE prepared by drop casting 0, 2.5, 5.0, 7.5 and 10.0  $\mu\text{L}$  of GQDs.

From Fig. 3.4, the anodic peak current of CAF-phenol was still remained from 0 to 5.0  $\mu\text{L}$  of GODs. However, from 5.0 to 7.5  $\mu\text{L}$ , the anodic peak current was rapidly increased because GODs increased the surface area and conductivity of the working electrode. Then, the anodic peak currents from 7.5 and 10.0  $\mu\text{L}$  had no significant difference and error bar at 10.0  $\mu\text{L}$  GODs was wider than at 7.5  $\mu\text{L}$ . This was probably caused by the high concentration of GODs leads to the aggregation of GQDs. Therefore, 7.5  $\mu\text{L}$  of GQDs were chosen and were used in the following experiments.

### 3.2.3 Electrochemical behavior of carbofuran

Fig. 3.5 illustrates cyclic voltammograms of 3 mM carbofuran-phenol in 0.1 M PB (pH 7.0) on four types of SPCE including bare SPCE, SPCE modified with IL (IL-SPCE), SPCE modified with GQDs (GQDs-SPCE) and SPCE modified with GQDs and IL (GQDs/IL-SPCE).



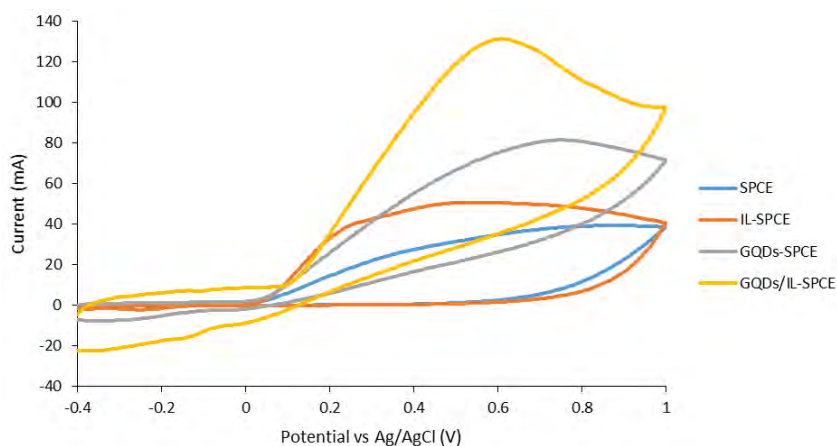

**Figure 3.5** The comparison of cyclic voltammograms of 3 mM carbofuran (CAF) in 0.1 M PB (pH 7.0) on a bare SPCE, IL-SPCE, GQDs-SPCE and GQDs/IL-SPCE using step potential of 5 mV and scan rate of 0.1 V/s.

As shown in Fig. 3.5, the bare SPCE showed the lowest response. Whereas, the IL-SPCE responded to the analyte better than SPCE due to the presence of IL which has an effect for enhancing the preconcentration of CAF-phenol at the electrode surface. This causes an improvement in the electron transfer process and enhancement in the electrochemical oxidation reaction of CAF-phenol. Meanwhile, the GQDs-SPCE responded to the analyte better than that the one modified with IL, maybe because the excellent properties of GQDs such as high specific surface area, high electrical conductivity and a lot of functional groups at their edges. Lastly, GQDs/IL-SPCE showed the strongest electrochemical response of CAF-phenol due to enhancement in the electron transfer process both via GQDs and IL resulting in increasing of electrochemical response. Therefore, the GQDs/IL-SPCE was chosen in this project.

### 3.3 The optimization of the DPV parameters

There is another famous carbamate pesticide in agricultural industry, Carbendazim (CAD), which is mostly use to eliminate fungi from plant. It can be contaminated in water, soil and agricultural products and can cause eyes, skin and gastrointestinal tract irritation. Especially, its toxicity can cause the abnormality on chromosome such as mutation. Therefore, the investigation of amount of CAD by determination of CAD-phenol is considered as well.

In this part, the simultaneous determination of CAF-phenol and CAD-phenol was studied by DPV of mixture of 0.5 mM CAF-phenol and 0.5 mM CAD-phenol on GQDs/IL-SPCE. In order to perceive the optimal condition, the effect of pulse potential, step potential, pulse time and scan rate were investigated. Generally, these parameters affected to height, sharpness, and separation of each peak.

### 3.3.1 Effect of pulse potential

The effect of pulse potential on anodic peak current of CAF-phenol and CAD-phenol on GQDs/IL-SPCE was studied in the range of 0.01 to 0.10 V.

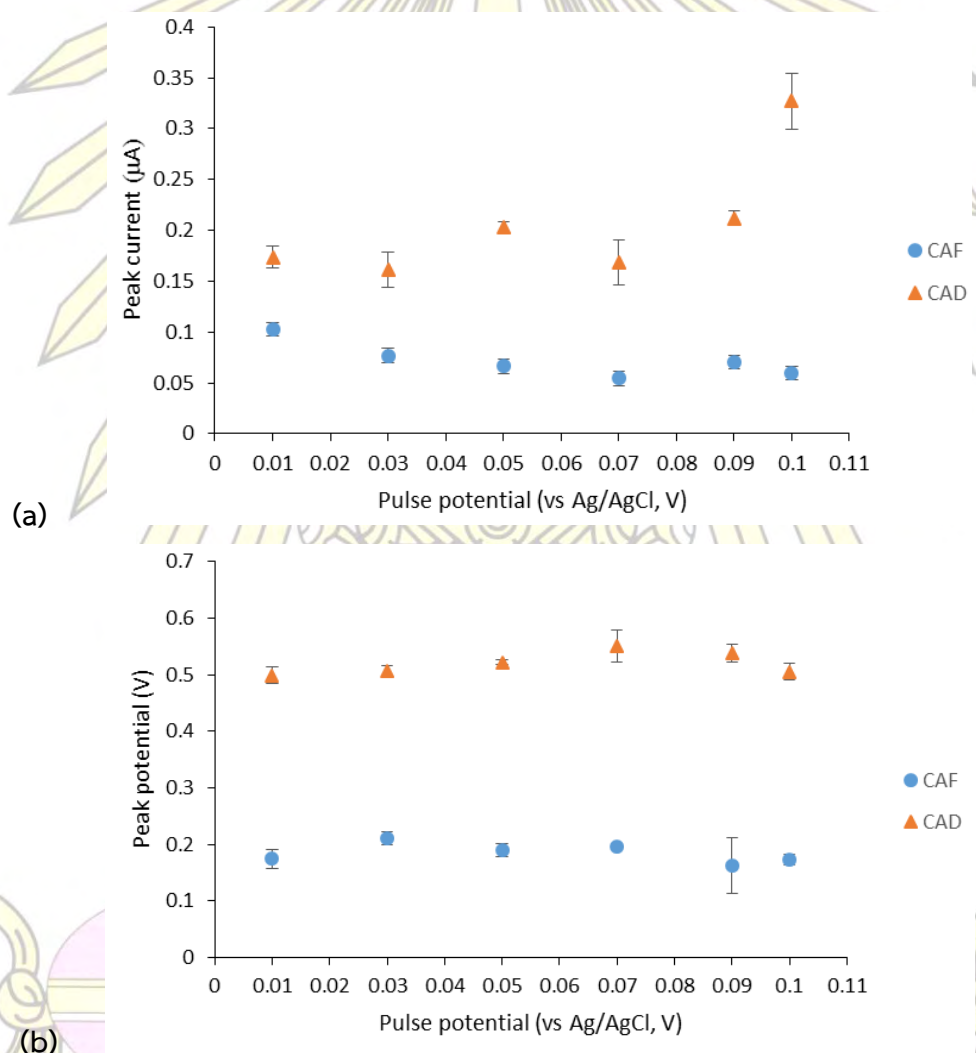

**Figure 3.6** Plots of anodic peak currents (a) and peak potentials (b) of a mixture of 0.5 mM carbofuran-phenol (CAF-phenol) and 0.5 mM carbendazim-phenol (CAD-phenol) in 0.1 M PB (pH 7.0) by DPV on GQDs/IL-SPCE at various pulse potential in the range of 0.01 to 0.10 V.



From Fig. 3.6, the highest peak current of CAD-phenol with wide error bar was obtained at the pulse potential of 0.10 V, while the maximum peak current of CAF-phenol was achieved at the pulse potential of 0.01 V. The pulse potential of 0.05 V was selected as an optimum value for simultaneous determination of CAF-phenol and CAD-phenol with good accuracy and precision.

### 3.3.2 Effect of step potential

The effect of step potential over the range of 0.002 to 0.023 V on anodic peak currents of CAF-phenol and CAD-phenol on GODs/IL-SPCE was studied.

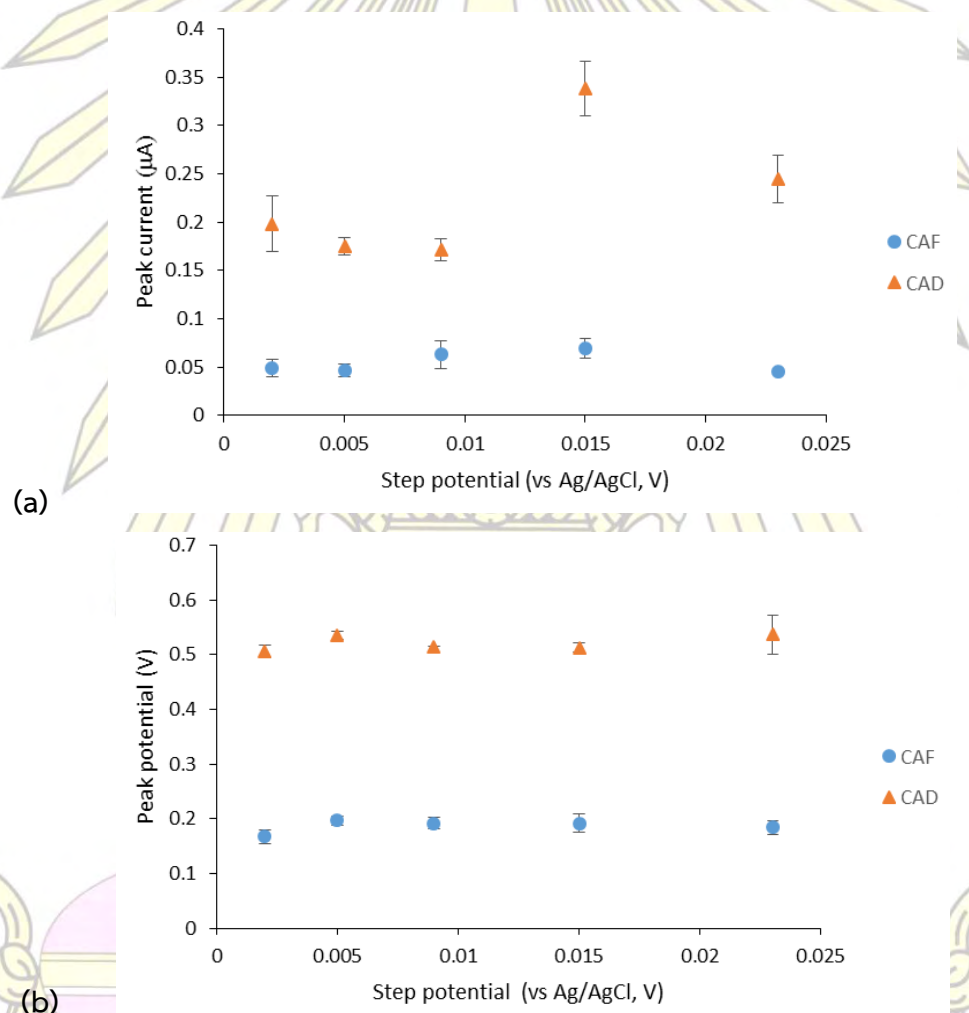
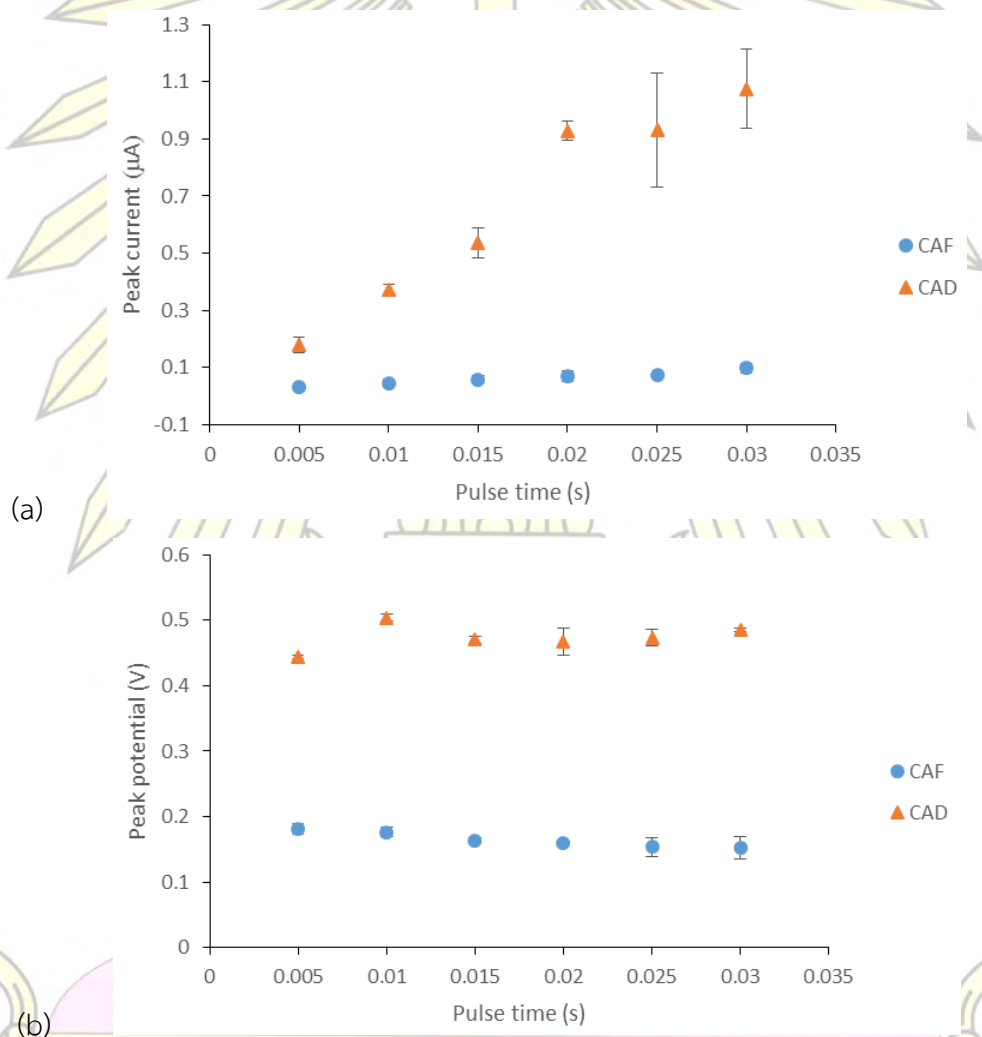

**Figure 3.7** Plots of anodic peak currents (a) and peak potentials (b) of a mixture of 0.5 mM carbofuran-phenol (CAF-phenol) and 0.5 mM carbendazim-phenol (CAD-phenol) in 0.1 M PB (pH 7.0) by DPV on GODs/IL-SPCE at various step potential in the range of 0.002 to 0.023 V.

From Fig. 3.7, the highest peak current of CAF-phenol and CAD-phenol were obtained at the step potential of 0.015 V; however it exhibited wide error bar for CAD-phenol. Therefore, the step potential of 0.005 V which provided lowest error bar of both analyte was selected for following study.

### 3.3.3 Effect of pulse time

The effect of pulse time on anodic peak currents of CAF-phenol and CAD-phenol on GQDs/IL-SPCE was studied in the range of 0.005 to 0.030 V.



**Figure 3.8** Plots of anodic peak currents (a) and peak potentials (b) of a mixture of 0.5 mM carbofuran-phenol (CAF-phenol) and 0.5 mM carbendazim-phenol (CAD-phenol) in 0.1 M PB (pH 7.0) by DPV on GQDs/IL-SPCE at various pulse time in the range of 0.005 to 0.030 V



From Figure 3.8, peak currents of CAF-phenol significantly increased with increasing pulse time from 0.005 to 0.030 s and very wide error bars were obtained at pulse time of 0.025 and 0.030 s. While, the peak current of CAD-phenol gradually increased when the pulse time was increased from 0.005 to 0.030 s. Therefore, the pulse potential of 0.020 s was chosen for the following study

### 3.3.4 Effect of scan rate

The effect of scan rate on anodic peak currents of CAF-phenol and CAD-phenol on GQDs/IL-SPCE was studied in the range of 0.010 to 0.125 V/s. Due to the lower pulse time than 0.010 V/s spent long time in measurement, so the determination of pulse time under 0.010 V/s was not performed.

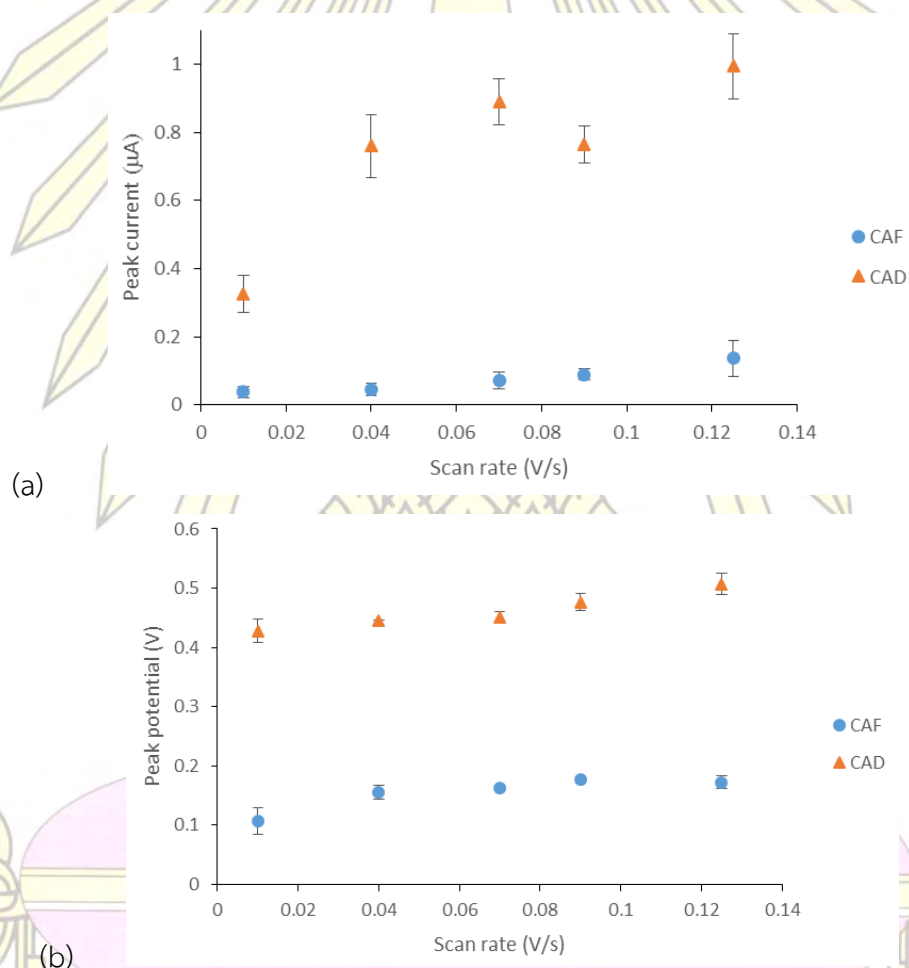

**Figure 3.9** Plots of anodic peak currents (a) and peak potentials (b) of a mixture of 0.5 mM carbofuran-phenol (CAF-phenol) and 0.5 mM carbendazim-phenol (CAD-phenol) in 0.1 M PB (pH 7.0) by DPV on GQDs/IL-SPCE at various scan rate in the range of 0.010 to 0.125 V/s.

From Figure 3.10, even though at scan rate of 0.125 V/s provided the highest peak current of CAF-phenol and CAD-phenol but also had wide error bar. At scan rate of 0.090 V/s, the peak current was lower than the one at scan rate of 0.070 V/s. Therefore, scan rate of 0.070 V/s was chosen

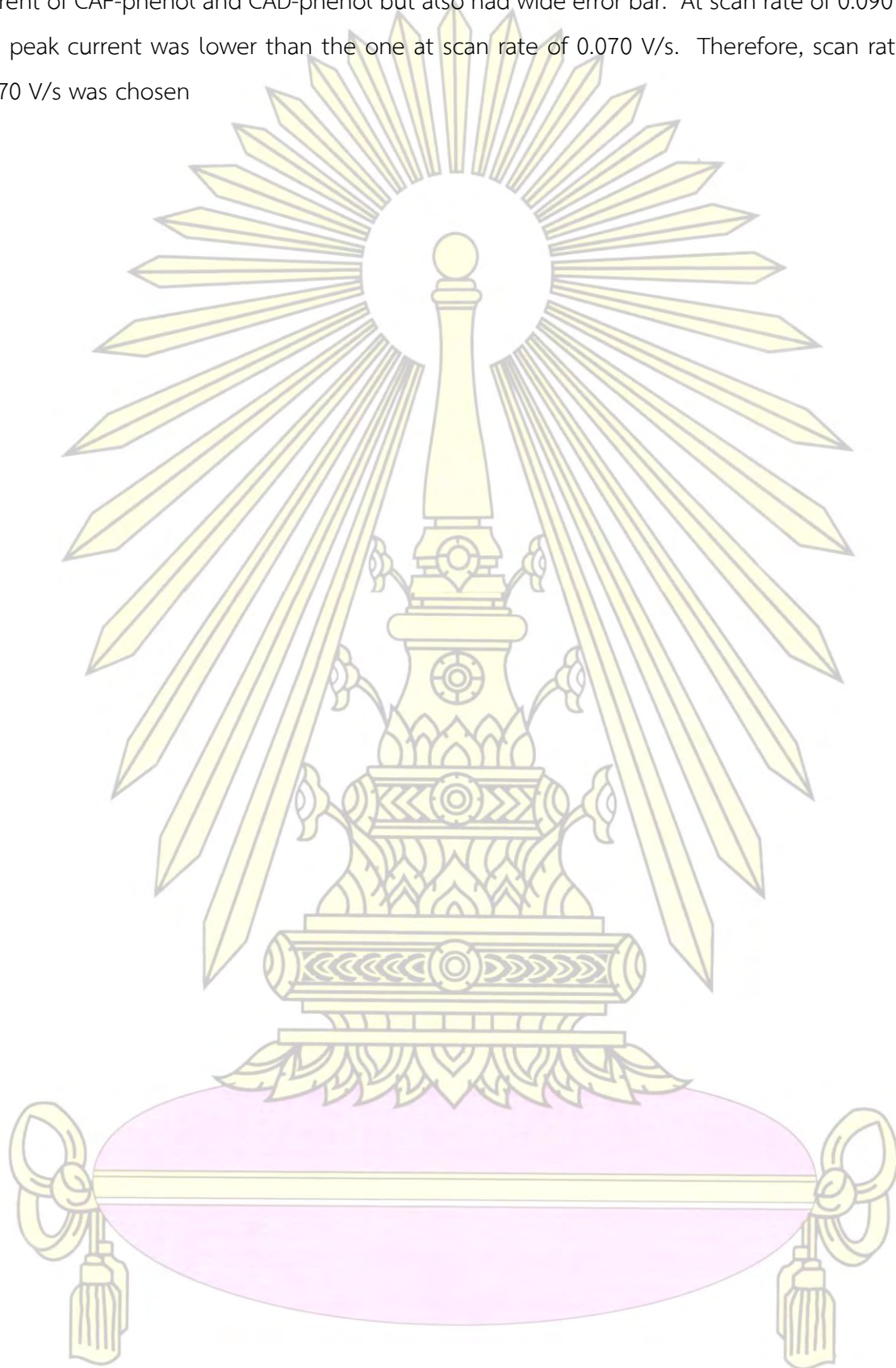



## CHAPTER IV

### CONCLUSION AND SUGGESTION FOR FURTHER STUDY

#### 4.1 Conclusion

In conclusion, a novel electrochemical sensor of which the modification of SPCE was based on GQDs and IL was developed for the determination of CAF. One of the modifiers which are GQDs were obtained easily by the pyrolysis of citric acid. They were confirmed as GQDs by characterization using UV-Vis spectroscopy and fluorescence spectroscopy. The optimal SPCE was modified under the optimized amount of IL and the optimized volume of GQDs (GQDs/IL-SPCE). The modified electrode showed good electrochemical response toward the oxidation of CAF-phenol. Moreover, GQDs/IL-SPCE exhibited the capability in the determination of CAD-phenol which showed good electrochemical response.

#### 4.2 Suggestion for further study

If there is a possibility to continue this project, the further study will include calibration curve of both CAF and CAD, linearity, limit of detection, limit of quantification, interference study and determination of CAF and CAD in real samples.



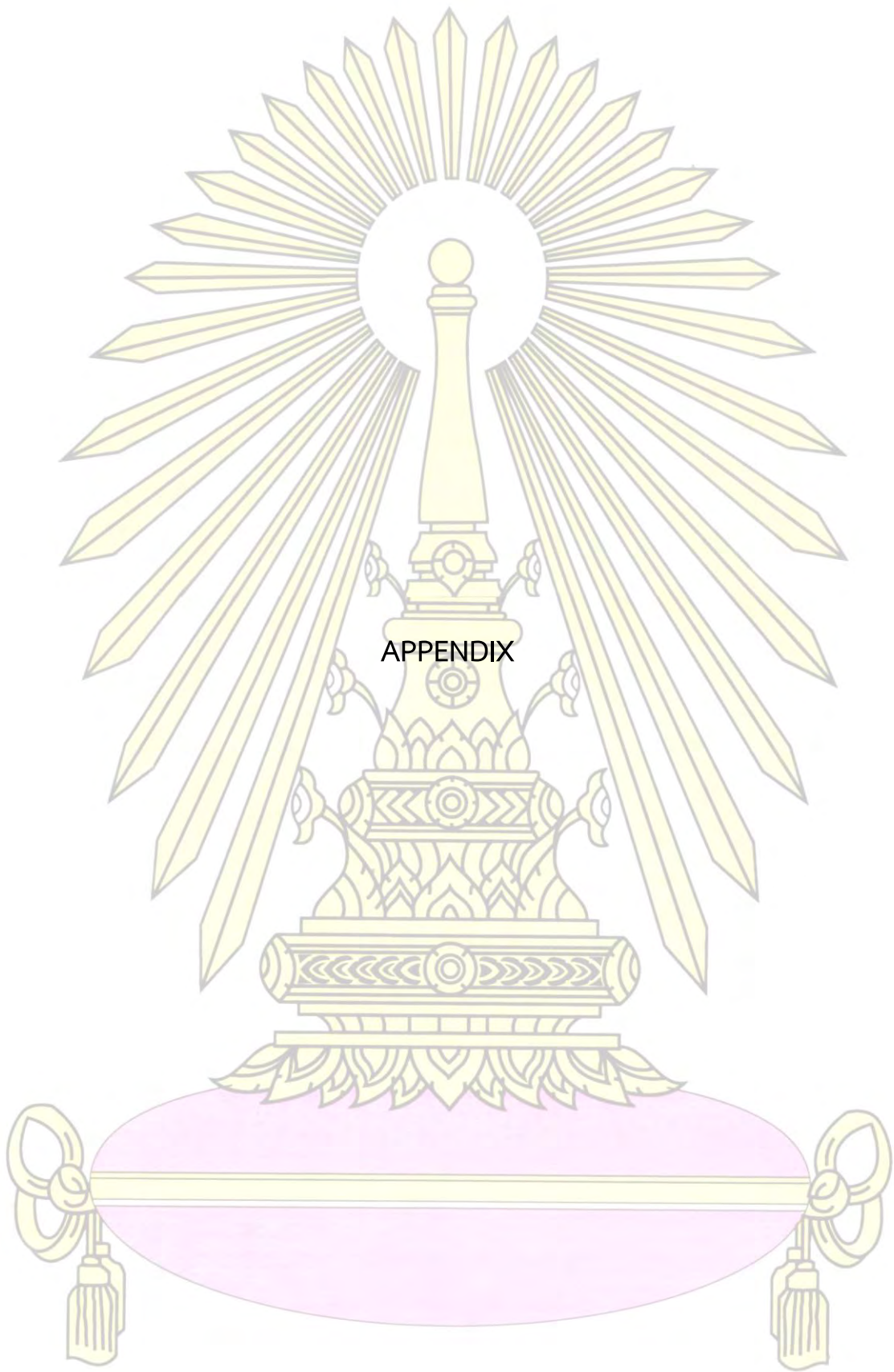

APPENDIX



## APPENDIX A

### Optimization of modified electrode

#### 1. The effect of amount of IL

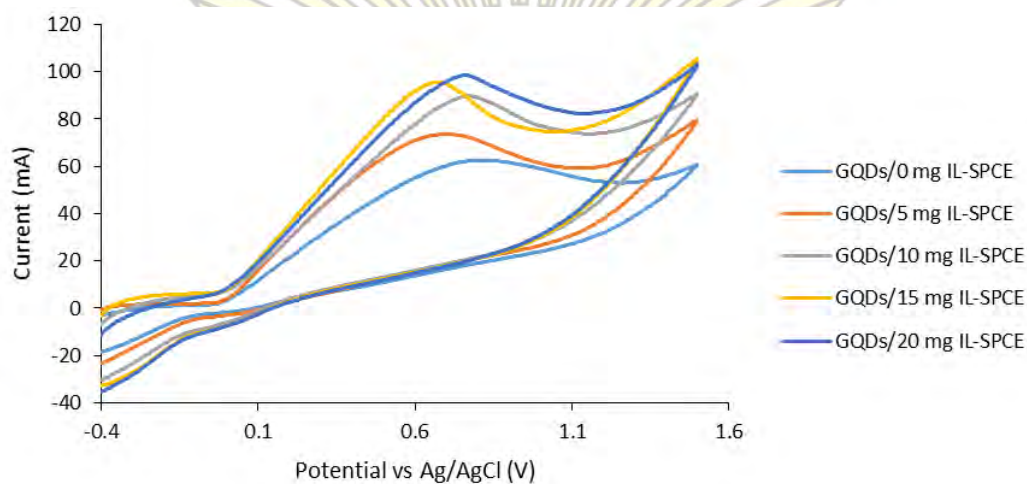

**Figure A1** The CV responses of 3 mM carbofuran-phenol (CAF-phenol) in 0.1 PB solution (pH 7.0) on the SPCE modified with GQDs and various amounts of IL.

#### 2. The effect of volume of GQDs

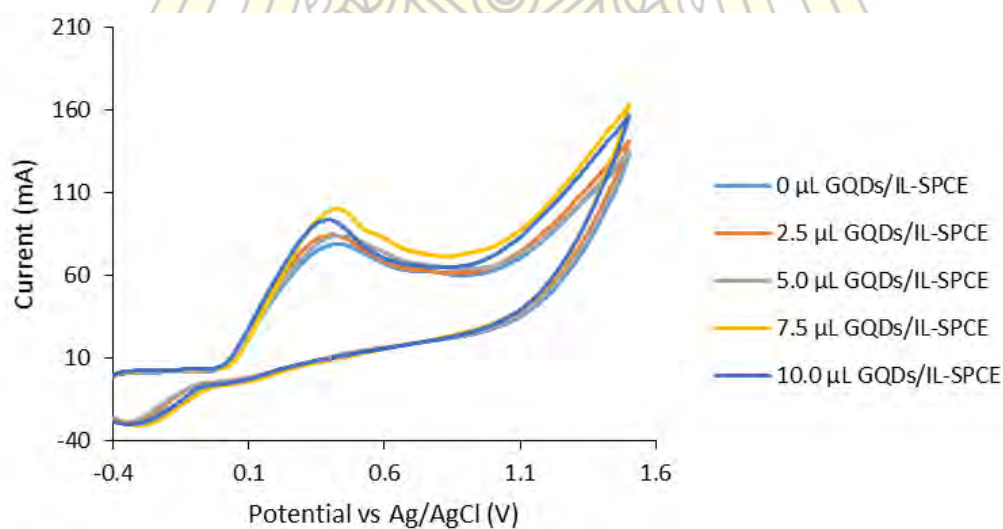
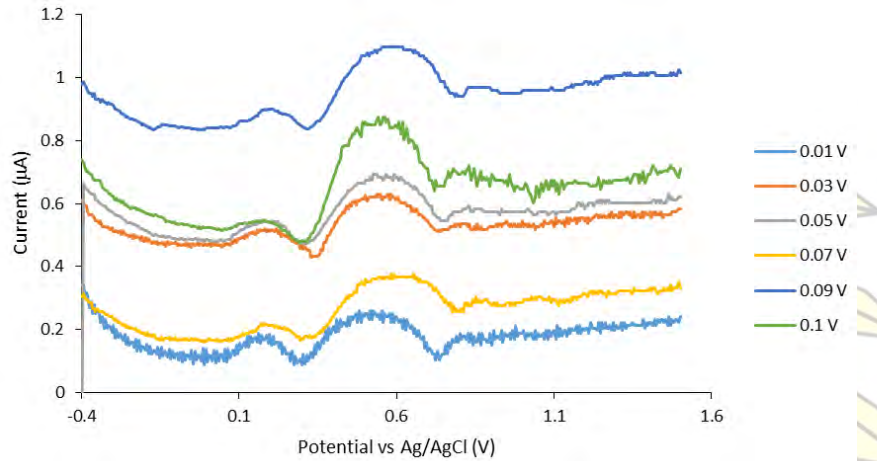

**Figure A2** The CV responses of 3 mM carbofuran-phenol (CAF-phenol) in 0.1 PB solution (pH 7.0) on the SPCE modified with IL and different volumes of GQDs.

## APPENDIX B

### The optimization of the DPV parameters

#### 1. Effect of pulse potential



**Figure A3** DPV responses of a mixture of 0.5 mM carbofuran-phenol (CAF-phenol) and 0.5 mM carbendazim-phenol (CAD-phenol) in 0.1 M PB (pH 7.0) on GQDs/IL-SPCE at various pulse potential in the range of 0.01 to 0.1 V.

#### 2. Effect of step potential

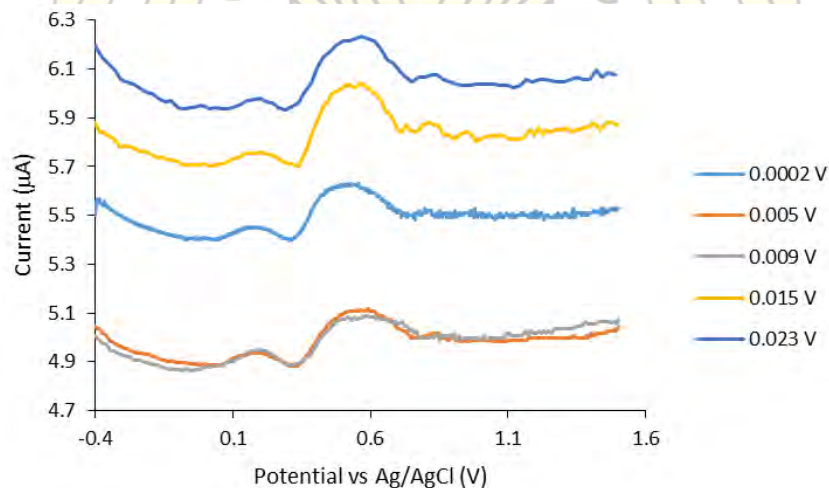

**Figure A4** DPV responses of a mixture of 0.5 mM carbofuran-phenol (CAF-phenol) and 0.5 mM carbendazim-phenol (CAD-phenol) in 0.1 M PB (pH 7.0) on GQDs/IL-SPCE at various step potential in the range of 0.0002 to 0.023 V.



### 3. Effect of pulse time

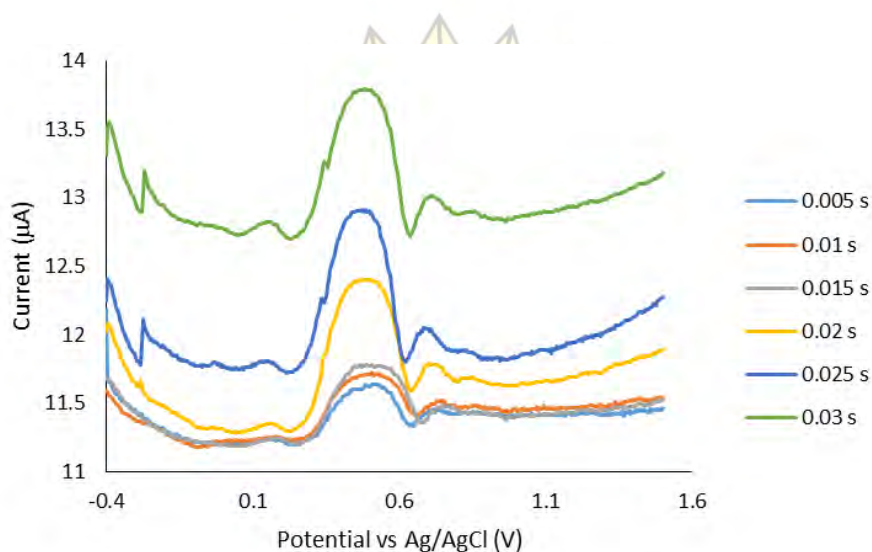

**Figure A5** DPV responses of a mixture of 0.5 mM carbofuran-phenol (CAF-phenol) and 0.5 mM carbendazim-phenol (CAD-phenol) in 0.1 M PB (pH 7.0) on GQDs/IL-SPCE at various pulse time in the range of 0.005 to 0.03 s.

### 4. Effect of scan rate

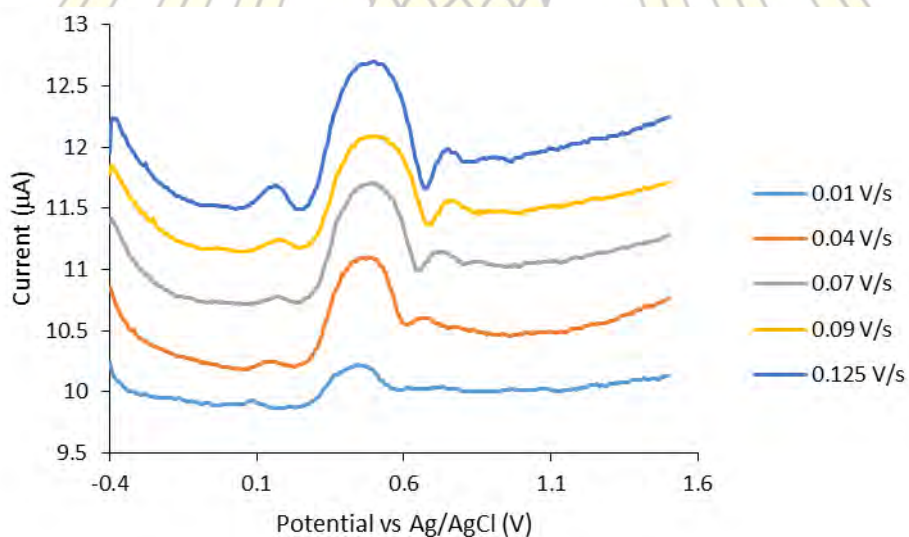

**Figure A6** DPV responses of a mixture of 0.5 mM carbofuran-phenol (CAF-phenol) and 0.5 mM carbendazim-phenol (CAD-phenol) in 0.1 M PB (pH 7.0) on GQDs/IL-SPCE at various scan rate in the range of 0.01 to 0.125 V/s.

## REFFERNCES

- [1] Cheng, X.; Wang, Q.; Zhang, S.; Zhang, W.; He, P.; Fang, Y. Determination of Four Kinds of Carbamate Pesticides by Capillary Zone Electrophoresis with Amperometric Detection at a Polyamide-modified Carbon Paste Electrode. *Talanta*. **2007**, 71, 1083–1087.
- [2] Pohanka, M.; Fusek, J.; Adam, V.; Kizek, R. Carbofuran Assay Using Gelatin Based Biosensor with Acetylcholinesterase as a Recognition Element. *Int. J. Electrochem. Sci.* **2013**, 8, 71-79.
- [3] Baron R. 1991. Carbamate Insecticides. In: Handbook of Pesticide Toxicology. Hayes W, Laws E eds, pp 1125-1189. New York: Academic Press.
- [4] Wong, A.; Materon, E.; Sotomayor, M. Development of a Biomimetic Sensor Modified with Hemin and Graphene Oxide for Monitoring of Carbofuran in Food. *Electrochim. Acta*. **2014**, 146, 830-837.
- [5] Sun, H.; Wu, L.; Wei, W.; Qu, X. Recent Advances in Graphene Quantum Dots for Sensing. *Mater. Today*. **2013**, 16, 433-442.
- [6] Dong, Y.; Shao, J.; Chen, C.; Li, C.; Wang, R.; Chi, Y.; Lin, X.; Chen G. Blue Luminescent Graphene Quantum Dots and Graphene Oxide Prepared by Tuning the Carbonization Degree of Citric Acid. *Carbon*. **2012**, 50, 4738-4743.
- [7] Jan, M.; Shah J.; Kham, H. Investigation of New Indirect Spectrophotometric Method for the Determination of Carbofuran in Carbamate Pesticides. *Chemosphere*. **2003**, 52, 1623-1626.
- [8] Chang, J.; Wei, G.; Zen, J. Screen-printed Ionic Liquid/preanodized Carbon Electrode: Effective Detection of Dopamine in the Presence of High Concentration of Ascorbic acid. *Electrochem. Commun*, **2011**, 13, 174-177.
- [9] Olek, M.; Blanchard F.; Sudraud G. Application de la détection électrochimique au dosage des résidus de quelques insecticides carbamates par chromatographie liquide haute performance. *J. Chromatogr. A*. **1985**, 325, 239.
- [10] Rasul Jaun, M.; Jasmin, S.; Khan, H. Investigation of New Indirect Spectrophotometric Method for the Determination of Carbofuran in Carbamate Pesticides. *Chemosphere*. **2003**, 52, 1623.



- [11] Wei, H; Sun, J; Wang, Y; Li, X; Chen, G. Rapid hydrolysis and electrochemical detection of trace carbofuran at a disposable heated screen-printed carbon electrode. *RSC Adv.* **2008**, 133, 1619-1624.
- [12] Hayat, A.; Marty, J. Disposable Screen Printed Electrochemical Sensors: Tools for Environmental Monitoring. *Sensors.* **2014**, 14, 10432-10453.
- [13] Zhang, R.; Qi, S.; Jia J.; Torre, B.; Zeng, H.; Wu, H.; Xu, X. Size and Refinement Edge-Shape Effects of Graphene Quantum Dots on UV-Visible Absorption. *J. Alloy Compd.* **2014**, 625, 186-191.
- [14] Freemantle, M. *An Introduction to ionic liquids*; RSC Pub: Cambridge, UK, 2010.
- [15] Singh, G.; Kumar, A. Ionic Liquids: Physico-chemical solvent properties and their applications in chemical processes. *Indian J.Chem A.* **2008**, 47A, 495-503.
- [16] Shukla, M.; Saha, S. *A Comparative Study of Piperidinium and Imidazolium Based Ionic Liquids: Thermal, Spectroscopic and Theoretical Studies*; INTECH Publisher: Rijeka, Croatia, 2013.
- [17] Shen, J.; Zhu, Y.; Yang, X.; Li, C. Graphene Quantum Dots: Emergent Nanolights for Bioimaging, Sensors, Catalysis and Photovoltaic Devices. *Chem. Commun.* **2012**, 48, 3686-3699.

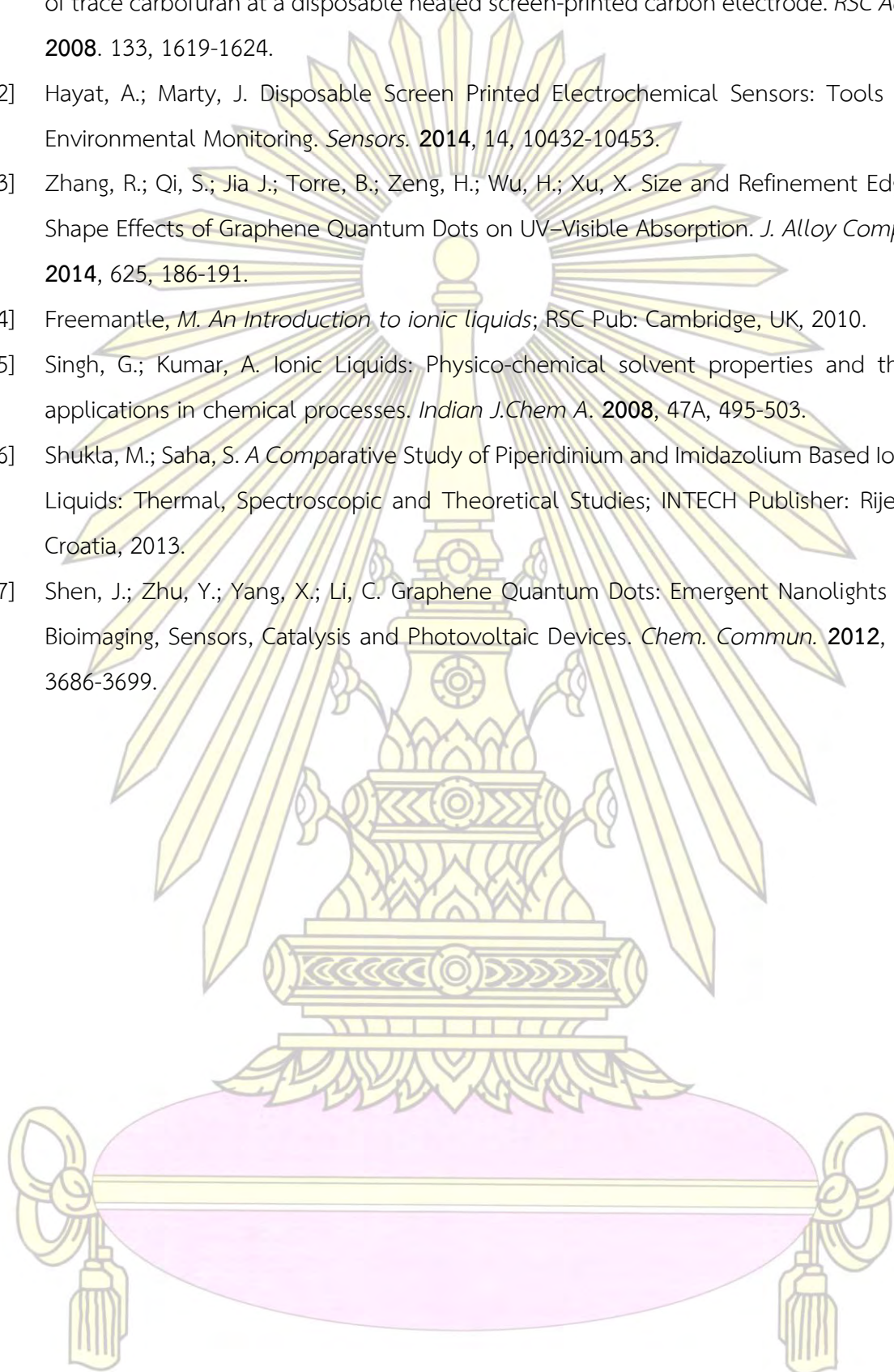



## VITA

Miss Pornlapas was born on February 10, 1994, Pranakorn Sri Ayutthaya, Thailand. She graduated from Horwang School with high school diploma in 2012 in Bangkok, Thailand. She is studying Chemistry since 2012 at Chulalongkorn University, Bangkok, Thailand. The available contact is 17/83 Vibhavadi Rd., Laksi, Bangkok, Thailand 10210. Email address: psmatoom@gmail.com

