

ผลของการผสมและกระบวนการขึ้นรูปต่อความเหนียวของพอลิคาร์บอเนต
ผสมสารฟลิกเหลวมวล โมเลกุลต่ำ



นางสาว นพวรรณ ไม้ทอง

สถาบันวิทยบริการ

วิทยานิพนธ์นี้เป็นส่วนหนึ่งของการศึกษาตามหลักสูตรปริญญาวิศวกรรมศาสตรมหาบัณฑิต

สาขาวิชาวิศวกรรมเคมี ภาควิชาวิศวกรรมเคมี

คณะวิศวกรรมศาสตร์ จุฬาลงกรณ์มหาวิทยาลัย

ปีการศึกษา 2545

ISBN 974-17-1849-7

ลิขสิทธิ์ของจุฬาลงกรณ์มหาวิทยาลัย

EFFECTS OF MIXING AND PROCESSING ON THE VISCOSITY
OF POLYCARBONATE BLENDS WITH LOW MOLAR MASS LIQUID CRYSTAL

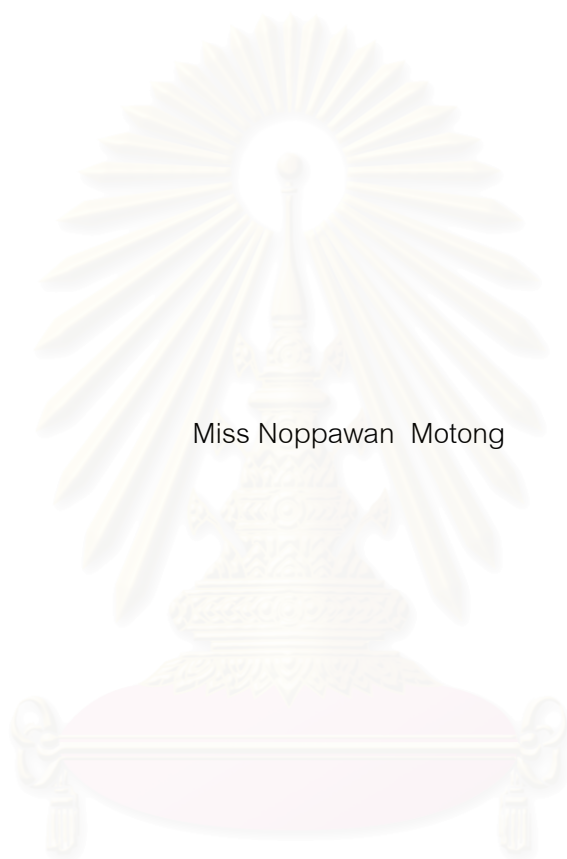

Miss Noppawan Motong

สถาบันวิทยบริการ
จุฬาลงกรณ์มหาวิทยาลัย
A Thesis Submitted in Partial Fulfillment of the Requirements
For the Degree of Master of Engineering in Chemical Engineering

Department of Chemical Engineering

Faculty of Engineering

Chulalongkorn University

Academic Year 2002

ISBN 974-17-1849-7

Thesis Title EFFECTS OF MIXING AND PROCESSING ON THE VISCOSITY OF
POLYCARBONATE BLENDS WITH LOW MOLAR MASS LIQUID
CRYSTAL

By Miss Noppawan Motong

Field of study Chemical Engineering

Thesis Advisor Assistant Professor M>. Supakanok Thongyai, Ph.D

Thesis Co-advisor Wannee Chinsirikul, Ph.D.

Accepted by the Faculty of Engineering, Chulalongkorn University in Partial
Fulfillment of the Requirements for the Master's Degree

.....Dean of Faculty of Engineering
(Professor Somsak Panyakeow, D.Eng.)

THESIS COMMITTEE

.....Chairman
(Professor Piyasan Prasertdam, Dr. Ing.)

.....Thesis Advisor
(Assistan Professor ML. Supakanok Thongyai, Ph.D.)

.....Thesis Co-Advisor
(Wannee Chinsirikul, Ph.D.)

.....Member
(Assistant Professor Siriporn Damrongsakkul, Ph.D.)

.....Member
(Assistant Professor Seeroong Prichanont, Ph.D.)

นพวรรณ ไม้ทอง : ผลของการผสมและกระบวนการขึ้นรูปต่อความหนืดของพอลิคาร์บอเนตผสมสารผลึกเหลวมวลโมเลกุลต่ำ (Effects of Mixing and Processing on the viscosity of Polycarbonate Blends with Low Molar Mass Liquid Crystal) อ.ที่ปรึกษา : ศศ.ดร.มล.ศุภกนก ทองใหญ่, อ.ที่ปรึกษาร่วม : ดร. วรณิ ฉินศิริกุล, 128 หน้า. ISBN 974-17-1849-7

งานวิจัยนี้ศึกษาผลของการผสมและกระบวนการขึ้นรูปต่อความหนืดของพอลิคาร์บอเนตผสม Cyclohexylbiphenylcyclohexane หรือ CBC33 ซึ่งเป็นสารผลึกเหลวมวลโมเลกุลต่ำ กับพอลิคาร์บอเนตสองชนิด คือ PC-2600 และ PC-2405 ที่มีค่าดัชนีการไหล 19.9 และ 23.1 กรัมต่อ 10 นาทีที่อุณหภูมิ 300 °C และน้ำหนัก 2.16 กก. ในขั้นแรกของการผสมระหว่างพอลิคาร์บอเนตและ CBC33 จะถูกเตรียมขึ้น โดยวิธีการกวนผสมแบบหลอมเหลวด้วยความร้อนที่อัตราส่วนผสม 0.1, 0.2, 0.4, 0.8 และ 1 เปอร์เซ็นต์โดยน้ำหนักของ CBC33 พอลิเมอร์ผสมที่ได้จะถูกนำไปทดสอบความหนืดเปรียบเทียบกับพอลิคาร์บอเนตบริสุทธิ์ พบว่าที่อัตราส่วนผสม 0.2 เปอร์เซ็นต์โดยน้ำหนักของ CBC33 เหมาะสมที่สุดเนื่องจากที่อัตราส่วนผสมสูงกว่า 0.2 เปอร์เซ็นต์ CBC33 สามารถลดความหนืดของพอลิเมอร์ผสมลงได้อีกเพียงเล็กน้อย

จากนั้นเปรียบเทียบผลของวิธีการผสมที่มีต่อความหนืดของพอลิเมอร์ผสม จากค่าความหนืดของของผสมที่ผสมด้วยวิธีการกวนผสมแบบหลอมเหลวด้วยความร้อน การผสมโดยใช้เครื่องอัดรีดแบบสกรูเดี่ยว และการผสมโดยเครื่องอัดรีดแบบสกรูคู่ ที่อัตราส่วนผสม 0.2 เปอร์เซ็นต์โดยน้ำหนักของ CBC33 ผลการทดลองได้แสดงให้เห็นว่าการผสมโดยใช้เครื่องอัดรีดแบบสกรูเดี่ยวมีผลให้ความหนืดของพอลิเมอร์ผสมต่ำที่สุด นอกจากนี้การผสมโดยวิธีอื่นก็ส่งผลให้ความหนืดของพอลิเมอร์ผสมลดลงต่ำกว่าพอลิคาร์บอเนตบริสุทธิ์เช่นกัน

งานวิจัยนี้ยังได้ทำการศึกษาเบื้องต้นถึงความเป็นไปได้ในการนำผลิตภัณฑ์ที่ได้จากพอลิเมอร์ผสมนี้กลับมาใช้ใหม่โดยทดสอบความหนืดของชิ้นส่วนทางวิ่ง (runner) จากกระบวนการฉีดขึ้นรูป พบว่า CBC33 แสดงให้เห็นถึงผลต่อความหนืดของผลิตภัณฑ์ได้ไม่ชัดเจนในช่วงอัตราเฉือนและความถี่ต่ำ จึงมีความน่าสนใจที่จะทำการทดสอบความหนืดของพอลิเมอร์ผสมนี้ในช่วงอัตราเฉือนสูง โดยใช้เครื่องทดสอบความหนืดแบบคาปิลลารี (capillary rheometer) ต่อไป

ภาควิชา.....วิศวกรรมเคมี.....ลายมือชื่อนิสิต.....
 สาขาวิชา.....วิศวกรรมเคมี.....ลายมือชื่ออาจารย์ที่ปรึกษา.....
 ปีการศึกษา.....2545.....ลายมือชื่ออาจารย์ที่ปรึกษาร่วม.....

4370348321 : MAJOR CHEMICAL ENGINEERING

KEY WORD: LOW MOLAR MASS LIQUID CRYSTAL / POLYCARBONATE BLEBDS / VISCOSITY

NOPPAWAN MOTONG: EFFECTS OF MIXING AND PROCESSING ON THE VISCOSITY OF POLYCARBONATE BLENDS WITH LOW MOLAR MASS LIQUID CRYSTAL. THESIS

ADVISOR: ASSISTANT PROFESSOR ML. SUPAKANOK THONGYAI, Ph.D., THESIS CO-

ADVISOR: WANNEE CHINSIRIKUL, Ph.D., 128 pp. ISBN 974-17-1849-7.

This research was to investigate the effects of mixing and processing on the viscosity of Polycarbonate blends with low molar mass thermotropic liquid crystals, Cyclohexylbiphenyl-cyclohexane (CBC33). Two different molecular weights of Polycarbonate used in this work had melt flow indices of 19.9 and 23.1 g/10min (300°C / 2.16kg.), denoted as PC-2600 and PC-2405, respectively. Stirring melt mix was utilized in the first step blending of Polycarbonates and CBC33 with content at 0.1, 0.2, 0.4, 0.8 and 1 percent by weight. Viscosity of the resulting blends were investigated and compared with the base Polycarbonate. The results showed that 0.2 percent by weight of CBC33 is the suitable concentration because at higher concentration the effects of CBC33 on the viscosity were less significant.

To further study the effects of mixing methods on the viscosity, mixing by stirring melt mix at 0.2 percent by weight of CBC33 were selected. By comparing stir melt mixing with mixing by single screw extruder and mixing by twin screw extruder at the same percent composition of CBC33, the results showed that the viscosity of the PC-2600 and PC-2405 blends prepared by single screw extruder had the lowest viscosity values. In addition, in most cases viscosities of Polycarbonate blends were lower than that for pure Polycarbonate.

This work also included preliminary study of the possibility of recycling Polycarbonate blends with CBC33. Viscosities of the runner from injection molded product were studied. The results revealed that CBC33 had slight effects on viscosities of PC-2600 and PC-2405 products at low shear rate levels. It should be interesting to further measure the viscosity of the blends by capillary rheometer at higher shear rates.

Department Chemical Engineering Student's signature.....
 Field of study..... Chemical Engineering Advisor's signature.....
 Academic year 2002 Co-advisor's signature.....

Acknowledgement

I would like to express my deeply gratitude to my advisor: Assistant Dr. ML. Supakanok Thonyai to his continuous guidance, enormous number of invaluable discussions, helpful suggestions and warm encouragement. I am also grateful to Professor Dr. Piyasarn Prasertdham and Assistant Professor Dr. Siriporn Damrongsakkul for serving as the chairman and the member of the thesis committee, respectively, whose comments were constructively and especially helpful.

The financial support from MTEC is gratefully acknowledge. I am also grateful to Dr. Wannee Chinsirikul to her guidance and encouragement.

Sincere thanks are made to the Department of Chemical Engineering, Burapa University for their assistance about rheometric measurement. School of Energy and Materials, King Mongkut's University of Technology Thonburi for their assistance about twin screw extruder. And King Mongkut's Institute of Technology North Bangkok for their assistance about injection molding machine.

Also thanks to Bayer Polymer Co., Ltd. for providing Polycarbonate and TPI Pcl. who supported HDPE used in this study.

Sincere thanks to all my friends and all members of polymer engineering research laboratory for their assistance.

Finally I would like to dedicate this thesis to my parents and my families, who generous supported and encouraged me through the year spent on this study.

	Page
Abstract (in Thai).....	iv
Abstract (in English).....	v
Acknowledgement.....	vi
Contents.....	vii
List of tables.....	xi
List of figures.....	xii
 Chapter	
1. Introduction.....	1
1.1 Objective of the Present Study.....	2
1.2 Scope of the Present Study.....	3
2. Literature.....	4
3. Theories.....	15
3.1 Poly(bisphenol A)carbonates, PC.....	15
3.1.1 General Properties.....	15
3.1.2 Applications of Poly(bisphenol A)carbonates.....	16
3.2 Liquid crystal.....	18
3.2.1 Introduction to the liquid crystal.....	18
3.2.2 Structure of Liquid Crystals.....	19
3.2.2.1 Smectic structure.....	19
3.2.2.2 Nematic structure.....	20
3.2.2.3 Cholesteric or chiral nematic structure.....	21
3.2.2.4 Discotic structure.....	22
3.2.3 Mesophasic Transition Temperature.....	22
3.3 Extrusion.....	24
3.3.1 General Features of Single Screw Extrusion.....	24
3.3.2 General Features of Twin Screw Extruders.....	26
3.4 Injection Moulding.....	27

	Page
3.5 Rheology.....	29
3.5.1 Introduction.....	29
3.5.2 Flow Classification.....	29
3.5.2.1 Steady Simple Shear Flow.....	30
3.5.2.2 Unsteady Simple Shear Flow.....	31
3.5.2.3 Simple extension.....	33
3.5.3 Description of non-Newtonian fluid behavior in shear.....	34
3.5.3.1 Time-independent non-Newtonian fluids.....	34
3.5.3.2 Time-dependent non-Newtonian fluids.....	37
3.5.3.3 Viscoelastic materials.....	38
3.6 Rheological Measurements.....	39
3.6.1 Parallel Plate.....	39
3.6.2 Melt Index.....	45
3.7 Rheological Models.....	47
3.7.1 Power Law Model.....	47
3.7.2 Cox and Mertz Method.....	47
3.7.3 Giesekus Model.....	47
4. Experiments.....	49
4.1 Materials.....	49
4.1.1 Poly (bisphenol A carbonate), PC.....	49
4.1.2 Additives.....	49
4.1.2.1 Cyclohexylbiphenylcyclohexane, CBC33.....	49
4.1.2.2 Glycerol monostearate, GMS.....	49
4.2 Equipment.....	50
4.2.1 Digital Hot Plate Stirrer.....	50
4.2.2 Single Screw Extruder.....	50
4.2.3 Twin Screw Extruder.....	50
4.2.4 Injection Molding Machine.....	50
4.2.5 Hydraulic Hot Press.....	51

	Page
4.2.6 Parallel Plate Rheometer.....	51
4.2.7 Melt Flow Index Test Machine.....	51
4.3 Mixing and Sample Preparation.....	51
4.3.1 Stirring melt mix.....	51
4.3.1.1 Master batch preparation.....	51
4.3.1.2 Mixing of PC and PCA with GMS.....	52
4.3.1.3 Mixing of PC and PCA with CBC33.....	52
4.3.2 Mixing by Single Screw Extruder.....	52
4.3.3 Mixing by Twin Screw Extruder.....	53
4.3.4 Samples preparation for rheometric measurements.....	53
4.3.5 Injection molding from Single screw and Twin screw extruder mixed.....	54
4.3.6 Sample preparation from injection molding for rheometric measurement.....	55
4.4 Method of Determination.....	55
4.4.1 Shear viscosity.....	55
4.4.2 Complex viscosity.....	56
4.4.3 Melt Flow Index.....	56
5. Results and Discussions.....	57
5.1 The roles of melt viscosities in different experiments.....	58
5.2 The reduction in melt viscosities according to lubricant (GMS).....	65
5.3 The trends of melt viscosities reduction according to LCC (CBC33).....	70
5.4 Samples from different mixing method and results of melt viscosities.....	76
5.5 Deviation of predicted viscosities from Giesekus model from the measured melt viscosities.....	91
5.6 Injection moulding facts that results from melt viscosity measurements.....	105
5.7 Melt Flow Index, melt viscosities and the roles of mixing methods.....	110
6. Conclusions and Recommendations.....	112
6.1 Conclusions.....	112

	Page
6.2 Recommendation for further studies.....	113
References.....	115
Appendix.....	118
Vita.....	128



สถาบันวิทยบริการ
จุฬาลงกรณ์มหาวิทยาลัย

List of Tables

xi

	Page
Table 3-1 Typical properties of Poly (bisphenal A) carbonate.....	16
Table 5-1 The Melt Flow Index of pure Polycarbonates and Polycarbonate blends with single screw extruder and twin screw extruder.....	110
Table B-1 Complex viscosity of PC-2600 and its blends with CBC33 at various range of frequency.....	119
Table B-2 Complex viscosity of PC-2600 and its blends with GMS at various range of frequency.....	120
Table B-3 Complex viscosity of PC-2405 and its blends with CBC33 at various range of frequency.....	121
Table B-4 Complex viscosity of PC-2405 and its blends with GMS at various range of frequency.....	122
Table B-5 Complex viscosity of PC-2600 and its blends with CBC33 by using single screw extruder and twin screw extruder.....	123
Table B-6 Complex viscosity of PC-2405 and its blends with CBC33 by using single screw extruder and twin screw extruder.....	124
Table B-7 Complex viscosity from injection molding products of PC-2600 and its blends with CBC33 by using single screw extruder and twin screw extruder.....	125
Table B-8 Complex viscosity from injection molding products of PC-2405 and its blends with CBC33 by using single screw extruder and twin screw extruder.....	126

List of Figures

xii

	Page
Figure 2-1 Viscosity vs. LCP content at fixed shear rate. T=260 °C.....	5
Figure 2-2 Viscosity vs. LCP content at fixed shear rate. T=290 °C.....	6
Figure 2-3 Logarithmic viscosity of blends of PC with 5, 10, 15 and 20 wt% PET/0.6PHB vs. logarithmic shear rate.....	8
Figure 2-4 Logarithmic viscosities of blends of PVDF with 5, 10, 15 and 20 wt% PET/0.6PHB vs. logarithmic shear rate.....	8
Figure 2-5 Logarithmic viscosities of blends of PBT with 5, 10, 15 and 20 wt% PET/0.6PHB vs. logarithmic shear rate.....	9
Figure 2-6 Logarithmic viscosities of blends of PP with 5, 10, 15 and 20 wt% PET/0.6PHB vs. logarithmic shear rate.....	9
Figure 2-7 Viscosity of PPESK/LCP blends at 340 °C.....	11
Figure 2-8 Complex viscosity of HIQ45/PC blends at 320 °C.....	12
Figure 2-9 Dynamic modulus of HIQ45/PC blends at 320 °C.....	13
Figure 3-1 The structure of Poly(bisphenol A) carbonates.....	15
Figure 3-2 The applications of Poly(bisphenol A) carbonates.....	17
Figure 3-3 (a) Smectic structure. (b) liquid crystal chemical structures of Smectic structure.....	20
Figure 3-4 (a) Nematic structure. (b) liquid crystal chemical structures of Nematic structure.....	21
Figure 3-5 (a) Cholesteric structure. (b) liquid crystal chemical structures of Cholesteric structure.....	21
Figure 3-6 (a) Discotic structure. (b) liquid crystal chemical structures of Discotic structure.....	22
Figure 3-7 Phase transition of Liquid Crystal.....	23
Figure 3-8 Schematic view of single screw extruder.....	24
Figure 3-9 Typical zone on an extruder screw.....	26
Figure 3-10 Different types of twin screw extruder.....	27
Figure 3-11 Schematic view of injection moulding machine.....	27

	Page
Figure 3-12 Type of steady simple shear flow.....	30
Figure 3-13 Shear stress vs. shear rate for (a) Bingham plastic (b) Pseudo-plastic fluid (c) Dilatant fluid.....	35
Figure 3-14 Schematic of a parallel plate rheometer.....	40
Figure 3-15 Schematic of melt index apparatus.....	46
Figure 5-1 Shear Viscosity of PC-2600 pure, PC-2600 blends with GMS 0.1%wt and Shear Viscosity of PC-2600 from Power law model versus shear rate.....	61
Figure 5-2 Shear Viscosity of PC-2405 pure, PC-2405 blends with GMS 0.1%wt and Shear Viscosity of PC-2405 from Power Law model versus shear rate.....	62
Figure 5-3 Shear Viscosity of PC-2600 pure, PC-2600 blends with CBC33 0.1%wt and Shear Viscosity of PC-2600 from Power Law model versus shear rate.....	63
Figure 5-4 Shear Viscosity of PC-2405 pure, PC-2405 blends with CBC33 0.1%wt and Shear Viscosity of PC-2405 from Power Law model versus shear rate.....	64
Figure 5-5 Shear Viscosity of PC-2600 versus shear rate at various compositions of GMS.....	66
Figure 5-6 Complex Viscosity of PC-2600 versus frequency at various compositions of GMS.....	67
Figure 5-7 Shear Viscosity of PC-2405 versus shear rate at various compositions of GMS.....	68
Figure 5-8 Complex Viscosity of PC-2405 versus frequency at various compositions of GMS.....	69
Figure 5-9 Shear Viscosity of PC-2600 versus shear rate at various compositions of CBC33.....	72
Figure 5-10 Complex Viscosity of PC-2600 versus frequency at various compositions of CBC33.....	73

	Page
Figure 5-11 Shear Viscosity of PC-2405 versus shear rate at various compositions of CBC33.....	74
Figure 5-12 Complex Viscosity of PC-2405 versus frequency at various compositions of CBC33.....	75
Figure 5-13 Shear Viscosity of PC-2600 blends with CBC33 by single screw extruder versus shear rate.....	77
Figure 5-14 Complex Viscosity of PC-2600 blends with CBC33 by single screw extruder versus frequency.....	78
Figure 5-15 Shear Viscosity of PC-2405 blends with CBC33 by single screw extruder versus shear rate.....	79
Figure 5-16 Complex Viscosity of PC-2405 blends with CBC33 by single screw extruder versus frequency.....	80
Figure 5-17 Shear Viscosity of PC-2600 blends with CBC33 by twin screw extruder versus shear rate.....	82
Figure 5-18 Complex Viscosity of PC-2600 blends with CBC33 by twin screw extruder versus frequency.....	83
Figure 5-19 Shear Viscosity of PC-2405 blends with CBC33 by twin screw extruder versus shear rate.....	84
Figure 5-20 Complex Viscosity of PC-2405 blends with CBC33 by twin screw extruder versus frequency.....	85
Figure 5-21 Shear Viscosity of PC-2600 pure versus shear rate.....	87
Figure 5-22 Complex Viscosity of PC-2600 pure versus frequency.....	88
Figure 5-23 Shear Viscosity of PC-2405 pure versus shear rate.....	89
Figure 5-24 Complex Viscosity of PC-2405 pure versus frequency.....	90
Figure 5-25 Complex viscosity of pure PC-2600, PC-2600 blend with GMS 0.1% wt and complex viscosity of pure PC-2600, PC-2600 blend with GMS 0.1% wt from Giesekus model versus angular frequency.....	93
Figure 5-26 Storage Modulus of PC-2600 versus frequency at various compositions of GMS.....	94

	Page
Figure 5-27 Loss Modulus of PC-2600 versus frequency at various compositions of GMS	95
Figure 5-28 Complex viscosity of pure PC-2600, PC-2600 blend with CBC33 0.1% wt and complex viscosity of pure PC-2600, PC-2600 blend with CBC33 0.1% wt from Giesekus model versus angular frequency.....	96
Figure 5-29 Storage Modulus of PC-2600 versus frequency at various compositions of CBC33.....	97
Figure 5-30 Loss Modulus of PC-2600 versus frequency at various compositions of CBC33.....	98
Figure 5-31 Complex viscosity of pure PC-2405, PC-2405 blend with GMS 0.1% wt and complex viscosity of pure PC-2405, PC-2405 blend with GMS 0.1% wt from Giesekus model versus angular frequency.....	99
Figure 5-32 Storage Modulus of PC-2405 versus frequency at various compositions of GMS.....	100
Figure 5-33 Loss Modulus of PC-2405 versus frequency at various compositions of GMS.....	101
Figure 5-34 Complex viscosity of pure PC-2405, PC-2405 blend with CBC33 0.1% wt and complex viscosity of pure PC-2405, PC-2405 blend with CBC33 0.1% wt from Giesekus model versus angular frequency.....	102
Figure 5-35 Storage Modulus of PC-2405 versus frequency at various compositions of CBC33.....	103
Figure 5-36 Loss Modulus of PC-2405 versus frequency at various compositions of CBC33.....	104
Figure 5-37 Shear Viscosity of PC-2600 products from injection molding versus shear rate.....	106

	Page
Figure 5-38 Complex Viscosity of PC-2600 products from injection molding versus frequency.....	107
Figure 5-39 Shear Viscosity of PC-2405 products from injection molding versus shear rate.....	108
Figure 5-40 Complex Viscosity of PC-2405 products from injection molding versus frequency.....	109
Figure A-1 Parallel plate rheometer.....	118
Figure A-2 Melt Flow Index Test machine.....	118
Figure C-1 Rheological behaviour of isotropic versus anisotropic melt.....	127

Chapter 1

Introduction

Many thermoplastics are now accepted as *engineering material*, that probably originated as a classification to distinguish the materials that could substitute metals in many applications. By such a criterion, thermoplastics have a disadvantage compared with metals because their properties change with time and have inferior strengths except in rather special circumstances. However, these disadvantages can be compensated by other advantages such as their low strength to density ratio, their resistance to many of the liquids that corrode metals.

Polycarbonate is classified as an amorphous engineering thermoplastic because of its excellent balance of toughness, clarity, and high heat deflection temperature. Major market segments where Polycarbonate have a broad range of applications are automotive, sheet (glazing), electronics, lighting and laser-read compact recording disks.

The engineering polymers especially Polycarbonate have a high viscosity and require higher processing temperatures than other thermoplastics to lower down the processing viscosity. However high processing temperature may deteriorate the excellent properties by thermal degradation. There are several processing additives to improve the processing properties at lower processing temperature such as Lubricant and Plasticizer, but they may cause negative effects to other important properties, especially mechanical properties of the final products.

Liquid crystal polymers (LCP) are the polymers whose molecules can align in some certain direction according to the temperature. LCP are known as reinforcing fillers because they can enhance the LCP& thermoplastic blends mechanical properties, but they also reduce the melt viscosity of the blend. However, this

phenomenon was found to be valid only at high percentage of liquid crystal polymers in the blends [Siegmann, A. et. al.1985].

The blend between low molar mass liquid crystal chemical (LCC) and engineering polymer can also reduce the melt viscosity but without detriment to the mechanical properties of the blend. In the United States Patent [4,434,262], Buckley, A. et. al. [1984] patented the improvement of melt processable blend comprising polymers selected from a group of polyolefins or polyesters with certain LCC. The added LCC can form an anisotropic melt phase at the melt processing temperature of the thermoplastic polymers pair [Powanusorn, S. et.al.2001].

As mentioned above, this present work has investigated the effects of mixing and processing conditions on the blend viscosity of Polycarbonate and LCC .A small concentration of LCC in the polymer is enough to generate the viscosity reduction phenomenon and will be further examined. Cyclohexylbiphenylcyclohexane (CBC33) from Merck co. Ltd., were chosen to blend with Polycarbonate because of their nematic region between the processing temperatures of Polycarbonate.

1.1 Objective of the Present Study

1.1.1 To investigate the effects of mixing and processing condition on the melt viscosity of Polycarbonate blended with low molar mass liquid crystal chemical (LCC).

1.1.2 To examine the viscosity of Polycarbonate blends with low molar mass liquid crystal in order to study the recycling possibilities.

1.2 Scope of the Present Study

1.2.1 The present report is concerned with two types of Polycarbonate having different melt flow index values (19.884g/10 min and 23.076g/10 min at 300°C /2.16kg.) and the low molar mass liquid crystal, Cyclohexyl- biphenylcyclohexane (CBC33).

1.2.2 Various mixing methods used in this study include stirring melted mixing, single screw extruder and twin screw extruder.

1.2.3 The products are processed by Injection moulding machine.

1.2.4 All of the mixtures viscosities are determined by parallel plate rheometric measurements both in shear sweep and frequency sweep.



สถาบันวิทยบริการ
จุฬาลงกรณ์มหาวิทยาลัย

Chapter 2

Literature

Buckley, A. Conciatori, A. B. and Calundann, G. W. [1984] investigated the blend of low molecular weight liquid crystalline compound and polyolefin / polyester. The main polymers were plasticized and the melt viscosity of blend was reduced by as much as 25 to 30 percent compared with the main polymer.

Sigemann, A., Dagan, A., and Kenig, S. [1985] prepared the polyblends of a liquid crystalline aromatic copolyester (based on 6-hydroxy-2-naphthanoic acid (HNA) and p-hydroxybenzoic acid) and an amorphous polyamide (PA) by melt mixing method. The rheological behavior of blends was very different from pure component and melted viscosity of blends changes very significantly. Only 5% composition of LCP blends to system could reduce the viscosity 20 – 25 times. The tensile mechanical behavior of the blends was improved, similar to polymer composites. The two-phases morphologies were found, depending on their compositions.

Blizard, K. G., and Baird, D., G. [1987] characterized the morphology of blends of polycarbonate and nylon 6,6 with the copolyester 60%HBA - 40%PET. They have found that some extensional flows were required for the coalescence and extension of the particulated LCP phases. Only 10 to 30 percent of LCP was required for the viscosity reduction of those polymers.

La Mantia, F. P., Valenza, A., Paci, M. and Magagnini, P. L. [1990] investigated the blends of nylon 6 and a liquid crystal copolyesteramide (LCP). The blends have been extruded at two different temperatures. The influence of the LCP content on the viscosity of the blends was strange; see **Figure 2-1** and **Figure 2-2** where the viscosity was reported as a function of the composition at fixed shear rate. Lowest viscosities were shown at both temperatures at different concentration ranges of the

LCP components of 10-20% at 260°C and 5-20% at 290°C. The reduced viscosity phenomenon has been interpreted in terms of formation of fibril and immiscibility between two phases.

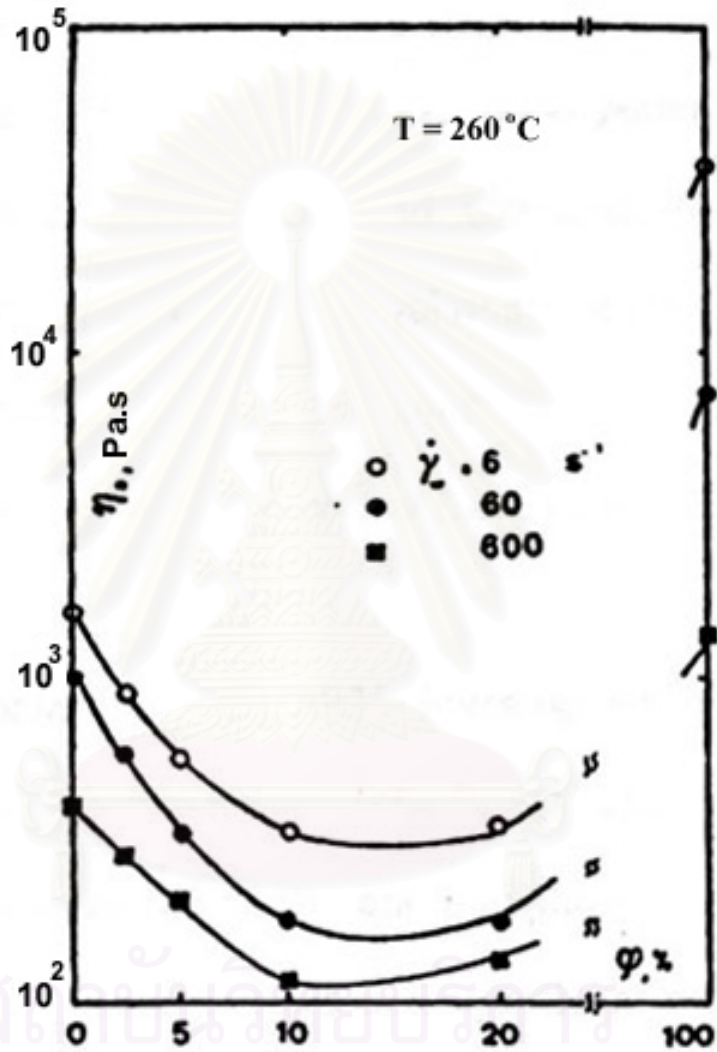

Figure 2-1 Viscosity vs. LCP content at fixed shear rate. $T=260^\circ\text{C}$ [La Mantia, et. at., 1990].

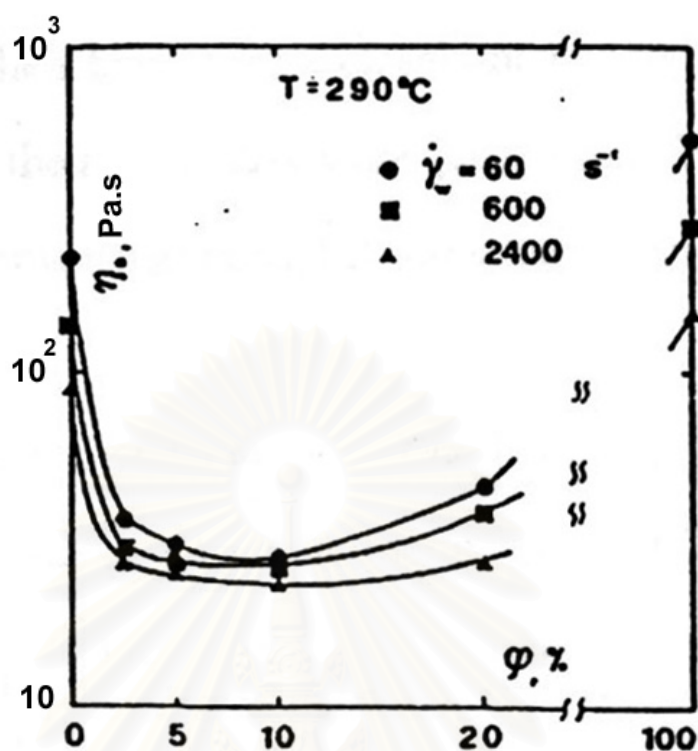

Figure 2-2 Viscosity vs. LCP content at fixed shear rate. $T=290 \text{ }^{\circ}\text{C}$ [La Mantia, et. at., 1990].

Heino, M. T. and Seppala, J. V. [1992] investigated blends of a polyester-type thermotropic liquid crystalline polymer (LCP) (Vectra A950) with poly(ethylene terephthalate) (PET), polypropylene (PP), and polyphenylene sulfide (PPS) respectively. They concluded that LCP was found to act as a significant reinforcement for all matrices studied. The tensile strength and elastic modulus of the blends increased with increasing LCP content, while the strain at break and the draw-ratio decreased. The improvements in strength and stiffness were most significant at higher LCP contents (20-30 wt%). However, at these compositions, the effects of draw ratio were greater. Moreover, they found that the mechanical properties of their blends were closely related to the blend morphologies. The melt viscosity of LCP and the pure matrix were quite similar in the shear rate ranges used in processing. However, at some shear rates, PP was slightly less viscous than PP and LCP blend.

Lin, Y. C., Lee, H. W. and Winter, H. H. [1993] studied the miscibility and viscoelastic properties of blends of a segmented block copolyester (LCP) and poly(ethylene terephthalate). They found that addition of a small quantity of LCP has a dramatic effect on rheology. For example, an addition of 2 wt% LCP reduces the viscosity by about 60%. This effects were most pronounced for PET of higher molar masses. The melt viscosity decreased exponentially with the LCP content in the ranges of composition where the blends were miscible. However, there was no further significant reduction of viscosity when the LCP contents exceed 50 wt%. The addition of LCP also changed the distribution of the relaxation times of PET and broadened the zero-shear viscosity regime.

Witold Brostow, Tomasz Sterzynski and Sebartian triouleyre [1996] studied rheological properties of binary blend of engineering polymers, Bisphenol-A-polycarbonate (PC), Poly(butylenes terephthalate) (PBT), isotactic polypropylene (PP) and Poly(vinylidene fluoride) (PVDF) with liquid crystalline polymer (PET/0.6PHB). Where PET was poly(ethylene terephthalate), PHB was p-hydroxybenzoic acid and 0.6 was the mole fraction of PHB in the copolymer. The blends concentration 20wt% PET/0.6PHB were studied. In all binary systems for all shear rates, the addition of PET/0.6PHB to an engineering polymer resulted in lowering of the melt viscosity (Figure 2-3 to Figure 2-6).

Witold Brostow, Michael Mess, Betty L. Lopez and Tomasz Sterzynski [1996] investigated the mechanical behaviors of blends on the basis of phase diagram. Connections between phase structures, the phase diagram and mechanical properties were studied for binary blends of Bisphenol-A-polycarbonate (PC) with PET/0.6PHB. The techniques used were Differential Scanning Calorimetry (DSC), Thermo Mechanical Analysis (T.M.A.) and Dynamic Mechanical Analysis (D.M.A.). Results show that glass transition temperature drop by $\sim 50^{\circ}\text{C}$ after annealing, with evident consequences for mechanical properties.

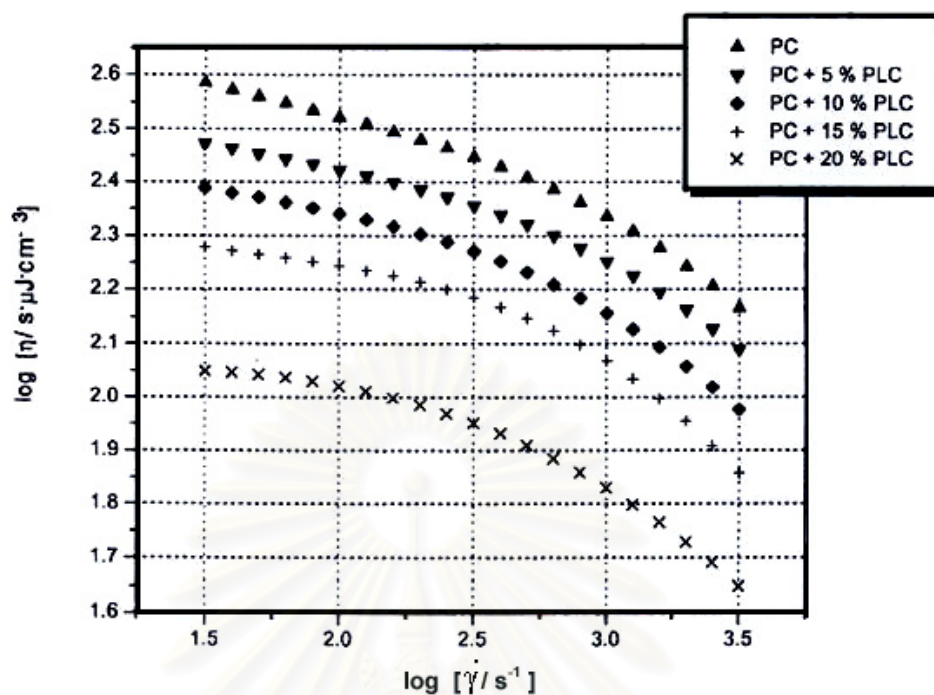

Figure 2-3 Logarithmic viscosity of blends of PC with 5, 10, 15 and 20 wt% PET/0.6PHB vs. logarithmic shear rate. [Brostow, W. et al., 1996]

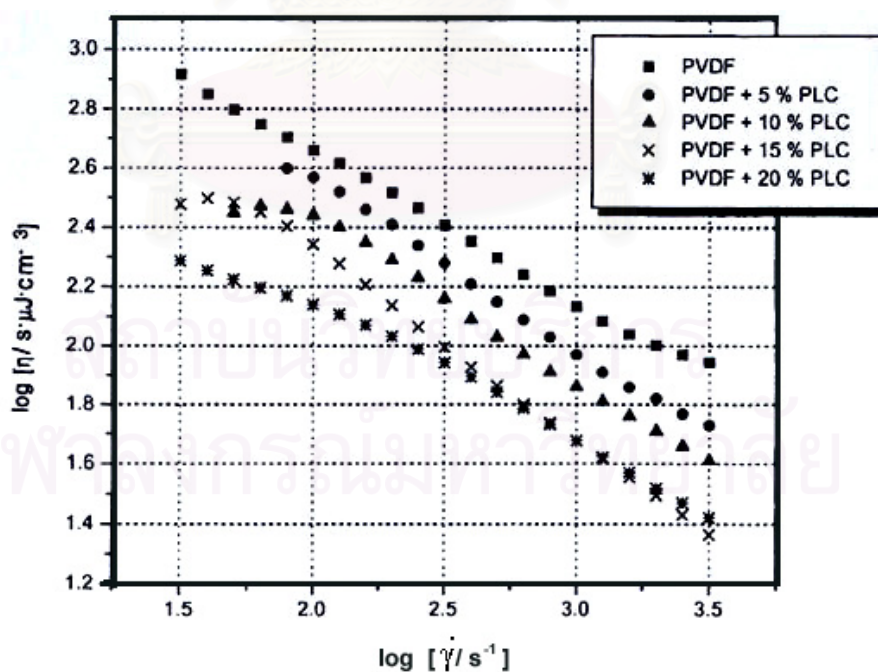

Figure 2-4 Logarithmic viscosities of blends of PVDF with 5, 10, 15 and 20 wt% PET/0.6PHB vs. logarithmic shear rate. [Brostow, W. et al., 1996]

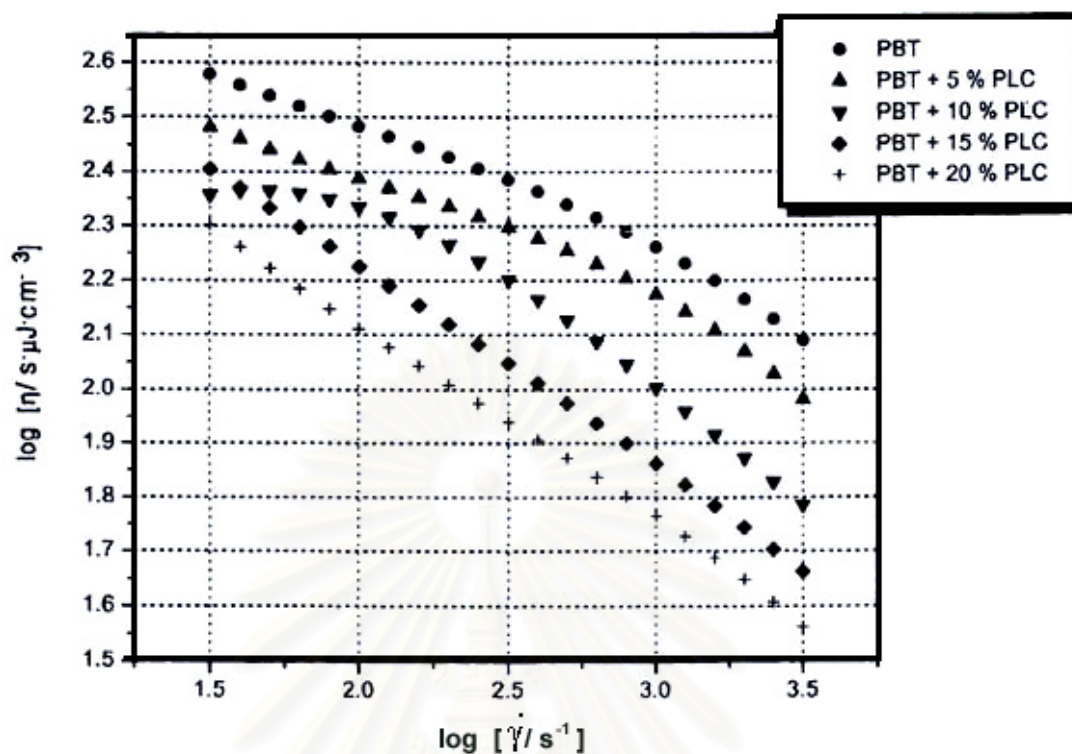

Figure 2-5 Logarithmic viscosities of blends of PBT with 5, 10, 15 and 20 wt% PET/0.6PHB vs. logarithmic shear rate. [Brostow, W. et al., 1996]

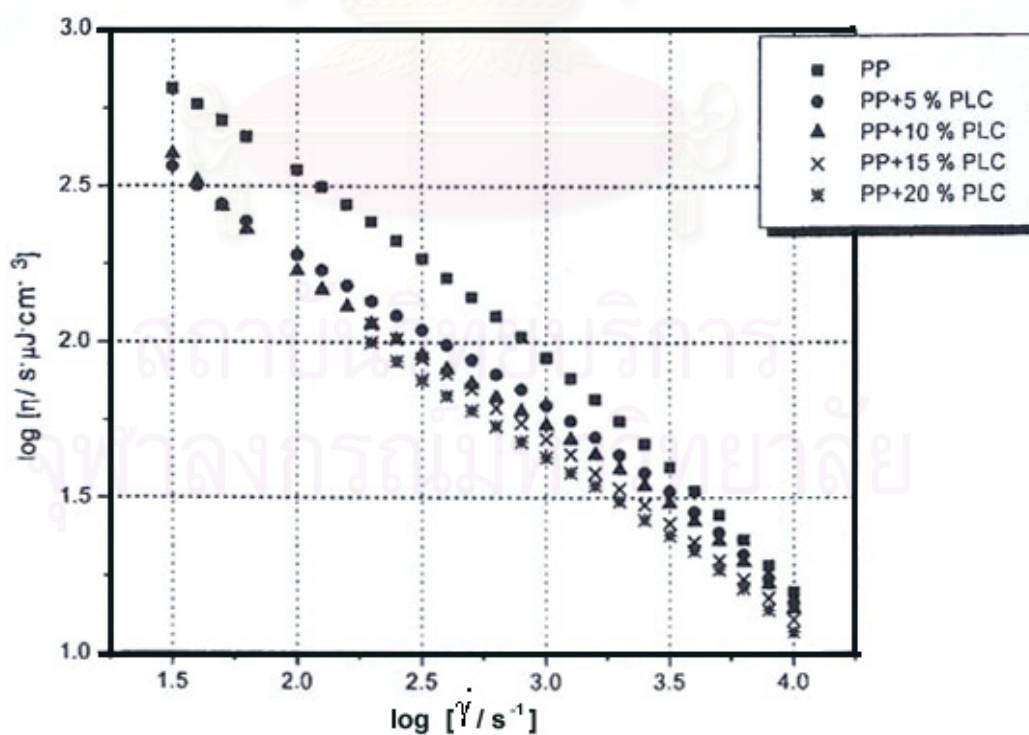

Figure 2-6 Logarithmic viscosities of blends of PP with 5, 10, 15 and 20 wt% PET/0.6PHB vs. logarithmic shear rate. [Brostow, W. et al., 1996]

G.L. Chik, R.K.Y. Li and C.L. Choy [1997] studied properties and morphologies of injection moulded liquid crystalline polymer / Polycarbonate blends by mechanical, ultrasonic and thermal expansivity techniques. The results were correlated with the morphologies by Scanning Electron Microscopy (SEM). They found that injection moulded LCP / PC blends exhibited a skin-core-skin-structure. In the skin layers, the LCP domains exhibited highly elongated fibrils, whilst in the middle of the core layer most of LCP domains exhibited spherical shapes and very few fibrils were observed.

Kulichikhin, V. G., Parsamyan, I. L., Lipatov, Y. S., Shunski, V. F., Getmanchuk, I. P., Babich, V. F., and Postema, A. R. [1997] investigated the rheological and mechanical properties of two phase polymer blends containing a liquid crystalline copolyester (LCP) of PHP/PET plus isotactic polypropylene (iPP) with various composition and concentration. The results shows that the perfect fibrillation of the disperse LC phase into iPP matrix in capillary flow was observed at LCP concentration more than 20%wt and temperature more than 488K. This effect led to the decrease of the blend viscosity and the reinforcing effects of the mechanical characteristic of the blends at the same time.

Meng, Y. Z., Tjong, S. C. and Hay, A. S. [1998] studied the melt blends of novel polyarylether, poly(phthalazinone ether ketone sulphone) copolymer, PPESK and a liquid crystalline copolyester based on Vectra A950. The PPESK is a high performance polymer that was characterized by an extremely high T_g, high stability but poor processability. The melted blends of PPESK and LCP at various compositions (5-35%) were investigated for the rheological behavior by a capillary rheometer. The results showed in **Figure 2-7** that at 340^oC, the viscosities of PPESK/LCP blends were significantly lower than that of the pure PPESK over the study ranges of shear rates. It was indicated that the processability of PPESK was greatly improved by blending with LCP.

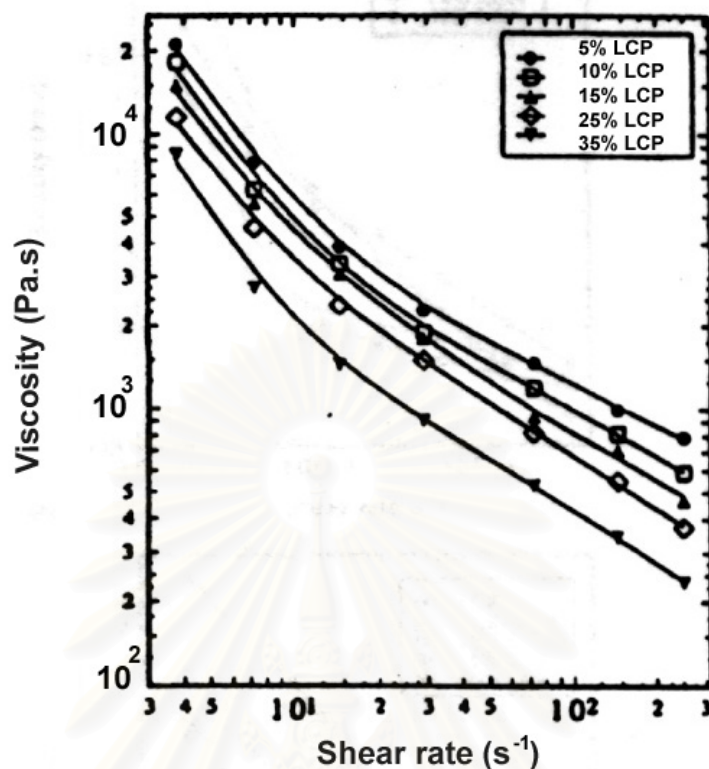

Figure 2-7 Viscosity of PPEsk/LCP blends at 340°C [Meng, et. at., 1998]

Thongyai, S. and Chuenchaokit, A. [1998] studied the properties of the blend systems of Bisphenol-A-polycarbonate (PC) with two low molar mass thermotropic liquid crystals in cyclohexyl-bisphenylcyclohexanes group CBC33 and CBC53. The shear viscosities were investigated using a capillary rheometer and experimental results showed that the viscosity of the blends with 1% of low molar mass liquid crystals was more than 50% lower than that of the pure polycarbonate. However, the glass transition temperature (T_g) detected by Differential Scanning Calorimeter (DSC) decreased only 3-5%.

Tsung-Tang Hsieh, Carlos Tiu, George P. Simon and Ru Yu Wu [1999] investigated the rheological properties of a thermotropic liquid crystalline polymer, HIQ45, when blended with a Bisphenol-A-polycarbonate (PC) at 10%, 20%, 30%, 50% and 75% of HIQ45. The behaviors of viscosities of HIQ45 and PC blends at 320°C

differed from the shear thinning behavior of HIQ45. All blends showed Newtonian behavior like PC even for the blend with an HIQ45 concentration of 75%. Blends with 20% and 30% HIQ45 content showed lower viscosities than both PC and HIQ45 (see Figure 2-8).

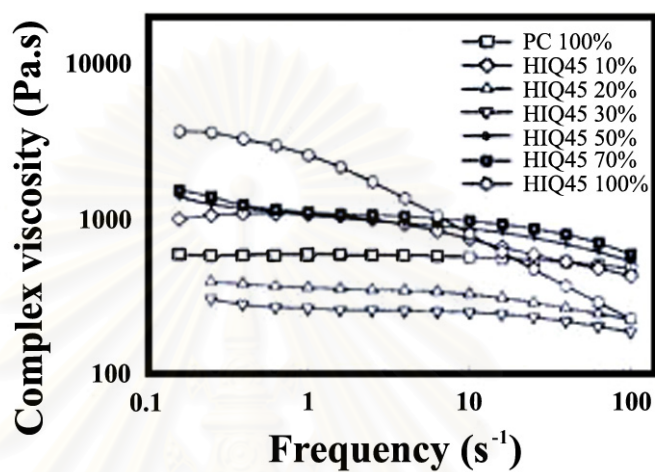

Figure 2-8 Complex viscosity of HIQ45/PC blends at 320 °C. [Hseih, T. T. et al., 1999]

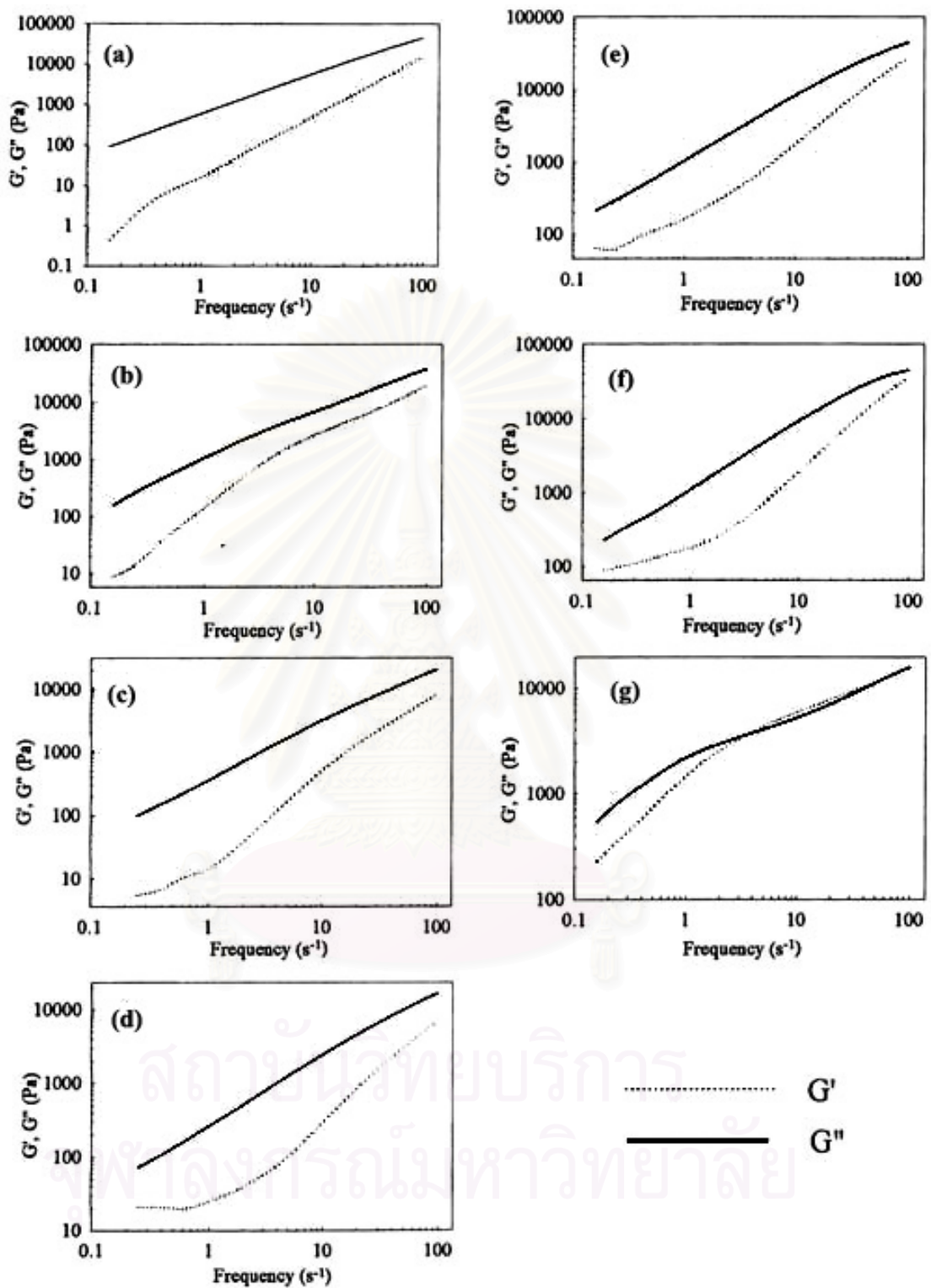

Figure 2-9 Dynamic modulus of HIQ45/PC blends at 320°C (a) PC (b) 10%HIQ45 (c) 20%HIQ45 (d) 30%HIQ45 (e) 50%HIQ45 (f) 75%HIQ45 (g) HIQ45 [Hseih, T. T. et al., 1999]

Xie, X. L., Tjong, S. C., and Li, R. K. Y. [2000] studied the ternary blend of poly(butylene terephthalate, PBT), polyamide 6,6 (PA6,6) and a liquid crystalline copolyester based on p-aminobenzoic acid (ABA) and poly(ethylene terephthalate, PET). The thermal, rheological and mechanical properties were investigated. The results showed that the melting temperatures of PBT/PA6,6 phase tended to be decreased with increased LCP content. The torque rheometer showed that the viscosity of the blends decreased dramatically at higher LCP concentration. Finally, the tensile tests showed that the stiffness and tensile strength of ternary in situ composites were generally improved with increasing LCP content.

Thongyai, S. and Powanusorn, S. [2001] investigated the rheological properties and mechanical properties (tensile strength) of the blends of PP, PC, POM, HDPE, SAN, PMMA in order to compare with base polymers without of liquid crystal(CBC33, CBC53, BCH5). The results showed that liquid crystal can reduce the melt viscosity of the base polymer while did not affect the mechanical properties of the base polymer. So the low molar mass liquid crystal may be applied as an additive for polymers.

สถาบันวิทยบริการ
จุฬาลงกรณ์มหาวิทยาลัย

Chapter 3

Theories

3.1 Poly(bisphenol A)carbonates,PC

Poly (bisphenol A) carbonates, PC is polyester of carbonic acid. Virtually all general purpose polycarbonates are based on bisphenol A as the repeating unit shown in Figure 3-1.

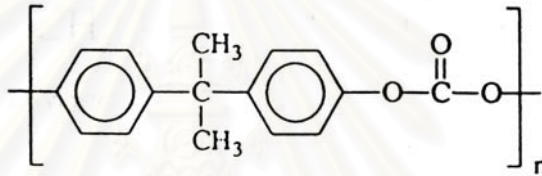

Figure 3-1 The structure of Poly (bisphenol A) carbonate. [Olabisi, 1997]

3.1.1 General Properties

Although somewhat more expensive than the general purpose thermoplastics, Polycarbonates have established themselves in a number of applications. The desirable features of the polymer may be listed as follow:

- (1) Rigidity up to 150°C.
- (2) Toughness up to 150°C.
- (3) Transparency.
- (4) Very good electrical insulation characteristics.
- (5) Virtually self-extinguishing.
- (6) Physiological inertness.

The principle disadvantage may be listed as:

- (1) More expensive than Polyethylene, Polystyrene and PVC.
- (2) Special care required in processing.

- (3) Pale yellow color (now commonly masked with dyes).
- (4) Limited resistance to chemicals and ultraviolet light.
- (5) Notch sensitivity and susceptibility to crazing under strain.

Table 3-1 Typical properties of Poly (bisphenol A) carbonate. [Olabisi, 1997]

Specific gravity (g/cm ³)	1.2
Refractive index (n _D ²⁵)	1.586
Tensile strength (psi)	8000-9500
Elongation (%)	100-130
Tensile modulus (10 ⁵ psi)	3.5
Impact strength (ft-lb/in . of notch)	12-17.5
Heat-deflection temperature (°F , 264 psi)	265-285
Dielectric constant (1000 cycles)	3.02
Dielectric loss (1000 cycles)	0.0021
Water absorption (one-eighth in bar, 24 hr., %)	0.15
Burning rate	Self-extinguishing
Effect of sunlight	Slight
Effect of strong acids bases	Attacked
Effect of organic solvents	soluble
Clarity	transparent

3.1.2 Applications of Poly(bisphenol A)carbonates

In spite of their rather complicated chemical structure, which consequently involves rather expensive production costs, the Polycarbonates have achieved an important place among the speciality plastics materials.

Success in the use of Polycarbonates arises from the advantages of toughness, rigidity, transparency, self-extinguishing characteristic, good electrical

insulation characteristic and heat resistance. The main factors retarding growth are the cost, the special care needed in processing, limitations in chemical and ultraviolet light resistance, moderate electrical tracking resistance and notch sensitivity.

Some polymers are rigid, some are as transparent, some are even both more rigid and as transparent, but Polycarbonate is the only material that can provide such a combination of properties, at least at such a reasonable cost. The application of polycarbonates therefore largely arise where at least two and usually three or more of the advantageous properties are required and where there is no cheaper alternative.

The largest single field of application for moulded Polycarbonates is in electronics and electrical engineering. Covers for time switches, batteries and relays, for example, utilize the good electrical insulation characteristics in conjunction with transparency, flame resistance and durability. Polycarbonates now dominate the compact disc market, where material of very high purity is required. The toughness and transparency of Polycarbonates has also led to a number of other industrial applications.



Figure 3-2 The applications of Poly(bisphenol A)carbonates. [Brydson, 1999]

3.2 Liquid crystal

3.2.1 Introduction to the liquid crystal

Liquid crystals were discovered more than a hundred years ago. They are defined as liquid material, which also have the high degree of anisotropy. One of the important manifestations of LCs is their melting behavior. When heating normal crystalline solid, it changes from solid phase directly to isotropic liquids at its crystalline melting point (T_m). In liquid crystalline materials, several different mesophases may form after their T_m and the mesophases will become isotropic at the higher transition temperature called clearing temperature. The transition properties of liquid crystals come from the rigid parts of their molecules, which are called mesogens. Mesogens may consist of low molecular weight compounds. They may be arranged along the main polymer chain or on side branches of the graft molecules.

The liquid crystalline state can be discovered as small molecules or polymers and generally requires special chemical structures. The chemical structures are composed of the central core comprising aromatic or cycloaliphatic units joined by rigid links or either polar or flexible alkyl and alkoxy terminal groups.

The mesophase may exist in solution state (Lyotropic liquid crystal) or in a melting state (Thermotropic liquid crystal). The ability of the polymers to form Lyotropic or Thermotropic liquid crystalline mesophases depends on the chemical structure of the molecules.

The formation of a Lyotropic liquid crystalline mesophase can be present alone or in equilibrium with an isotropic liquid phase. At higher polymer concentrations the liquid crystalline mesophase can be present in equilibrium with crystalline solid.

The presence of mesogenic groups is important for the anisotropic formation of liquid crystals in solutions and melts, but the occurrence of liquid crystals also depends on many other factors such as temperature. Liquid crystals form only in a certain temperature range which lies between the melting point, T_m and the upper transition temperature at which a liquid crystalline phase changes into an isotropic liquid

or clearing point, T_i . This temperature is also called the temperature of isotropisation or the solution point. If the material being tested does not crystallize, liquid crystals are formed between the glass transition temperature, T_g , and the temperature of isotropisation T_i .

In order to use liquid crystals, it is essential that the range of the mesophase extends over a wide temperature range. However, compounds containing a mesophase, particularly polymer, have a high melting point, and the melting point of crystals is often a limiting factor, since the range of liquid crystalline transition may be located in the range of thermal decomposition.

3.2.2 Structure of Liquid Crystals

Many kinds of mesophases can be classified by the different ways of the molecular arrangements. The anisotropic region ends at the clearing temperature because of the completely disordering of the molecules. There are many different types of liquid crystals. However, the major liquid crystal mesophase topologies are shown in Figure 3-3 to Figure 3-6.

3.2.2.1 Smectic structure

In the smectic structures, long molecules are arranged side by side in layers much like those in soap films. The term smectic (soap like) derives from the Greek word for grease or slime. The layers are not strictly rigid, but they are flexible. Two dimensional molecular sheets can slide past each other (Figure 3-3). Molecular motion is rather slow, so smectic mesophases are quite viscous.

Optically smectic layers behave like uniaxial, birefringent crystals. The intensity of light transmitted parallel to the molecular layer is greater than that transmitted perpendicularly. The temperature dependence of smectic interval tested by birefringence has slightly small effect to internal order.

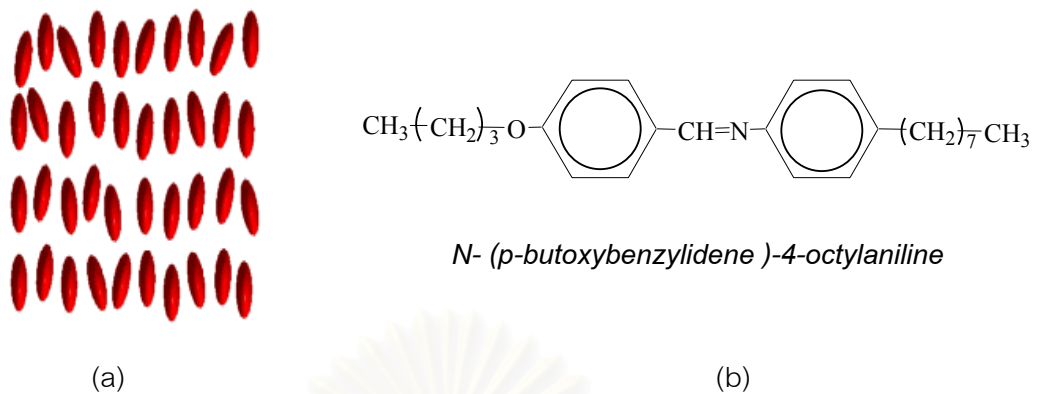

Figure 3-3 (a) Smectic structure. (b) liquid crystal chemical structures of Smectic structure. [Sperling, 2001]

3.2.2.2 Nematic structure

The molecular organization, classified as a nematic mesophase, involves in the irregular alignment in one dimension. Molecules remain parallel to each other in the nematic structure (Figure 3-4), but the position of their gravitational centers are disorganized. Molecules of nematic liquid crystals can be oriented in one dimension. Their mobilities can be reduced by the attraction to supporting surfaces. For examples, nematic molecules tend to lie parallel to the rough surface of a glass slide. A bright satin-like texture is observed when nematic liquid crystals are viewed between crossed polaroids. Characteristic dark threads appear at lines of optical discontinuity. These wavering filaments give the mesophase its name; take from the Greek word nematos, meaning fiber.

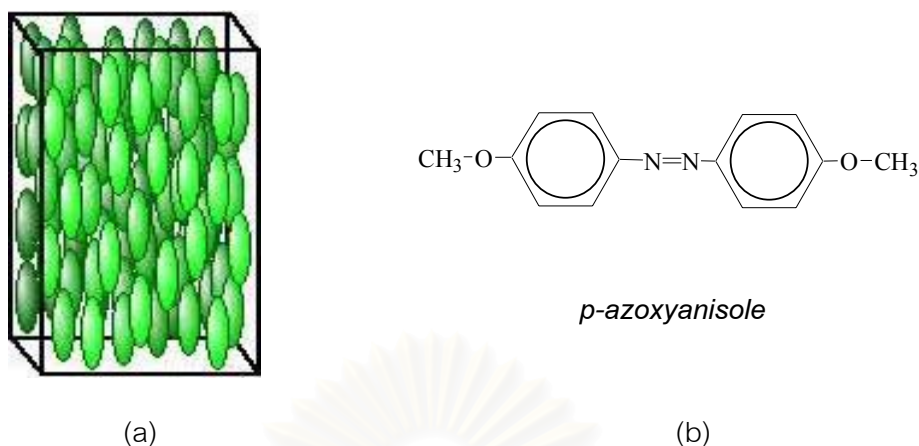

Figure 3-4 (a) Nematic structure. (b) liquid crystal chemical structures of Nematic structure. [Sperling, 2001]

3.2.2.3 Cholesteric or chiral nematic structure

The cholesteric structure is the third type of liquid crystal behaviors. It is so named because many compounds that form this mesophase are the derivatives of cholesterol. A cholesteric structure (**Figure 3-5**) is the shape of a nematic phase which is periodically wrapped around the axis. When chiral groups are present, the basic structure is helicoidal.

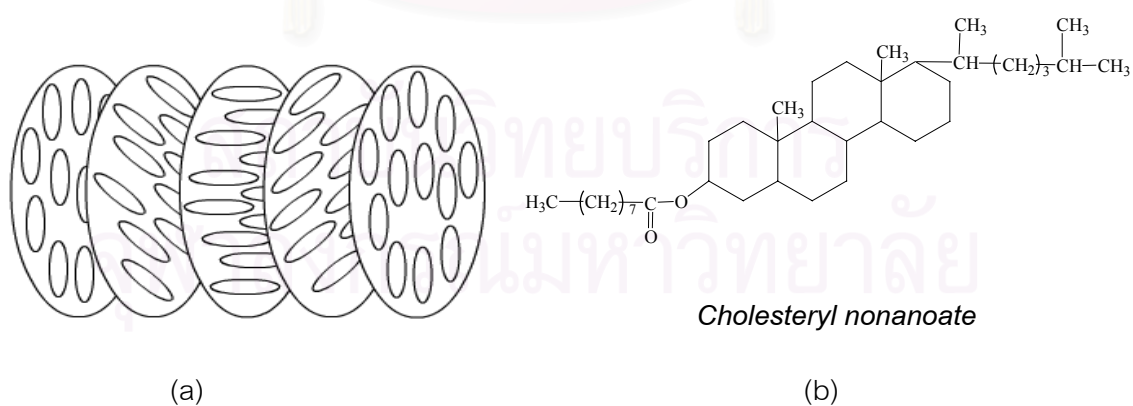

Figure 3-5 (a) Cholesteric structure. (b) liquid crystal chemical structures of Cholesteric structure. [Sperling, 2001]

3.2.2.4 Discotic structure

The discotic structure is the fourth type of liquid crystal behaviors. The discotic mesophase resemble stacks of dishes or coins (Figure 3-6).

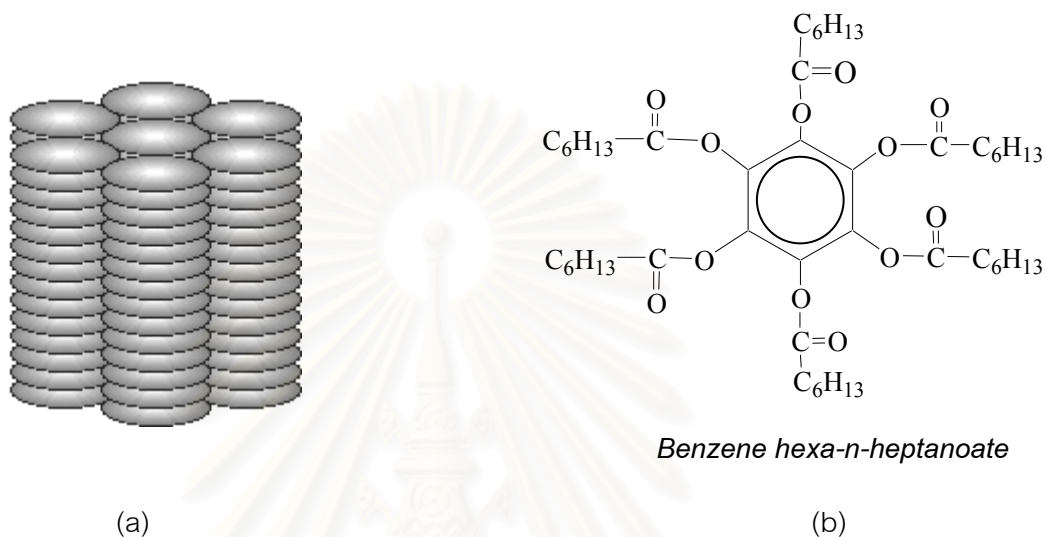

Figure 3-6 (a) Discotic structure. (b) liquid crystal chemical structures of Discotic structure. [Sperling, 2001]

3.2.3 Mesophasic Transition Temperature

Liquid crystals can undergo various phase transitions as the temperature increases from the ordered to the least ordered states, can be shown as Figure 3-7.

The temperature, when liquid crystal changes form crystal to the first liquid crystalline phase, is called “crystalline melting temperature” (T₃).

The temperature, when liquid crystal changes form smectic phase to nematic phase, is called “S → N transition temperature” (T₄).

The temperature, when the last (or only) liquid crystalline phase gives way to the isotropic melt or solution, is called “clearing temperature” (T₅).

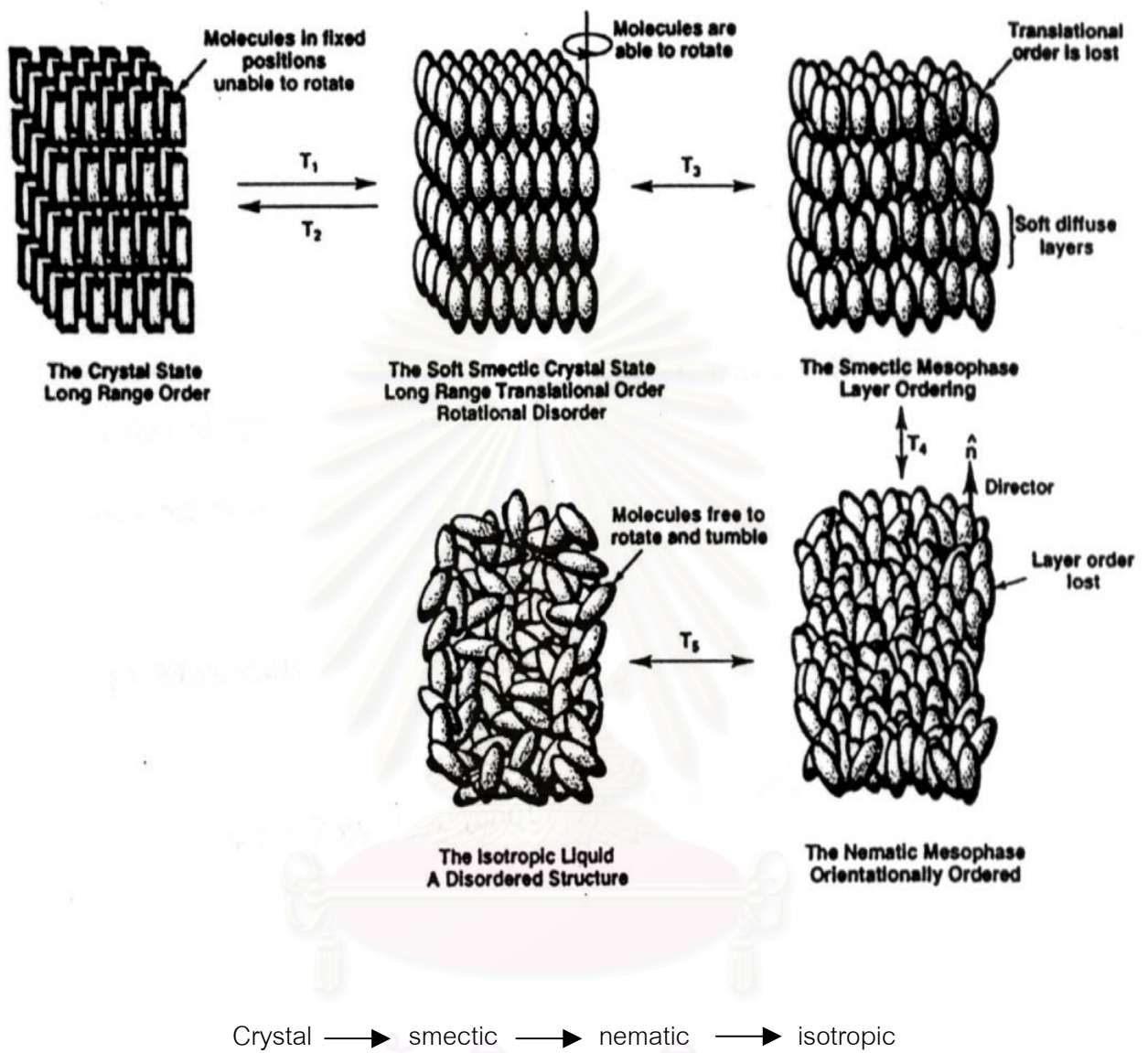

Figure 3-7 Phase transition of Liquid Crystal [Demas, et. Al., 1998]

3.3 Extrusion

3.3.1 General Features of Single Screw Extrusion

One of the most common methods of processing plastics is Extrusion using a screw inside a barrel as illustrated in Figure 3-8. The plastic, usually in the form of granules or powder, is fed from a hopper on to the screw. It is then conveyed along the barrel where it is heated by conduction from the barrel heaters and shear due to its movement along the screw flights. The depth of the screw channel is reduced along the length of the screw so as to compact the material. At the end of the extruder the melt passes through a die to produce an extrudate of the desired shape. As will be seen later, the use of different dies means that the extruder screw/barrel can be used as the basic unit of several processing techniques.

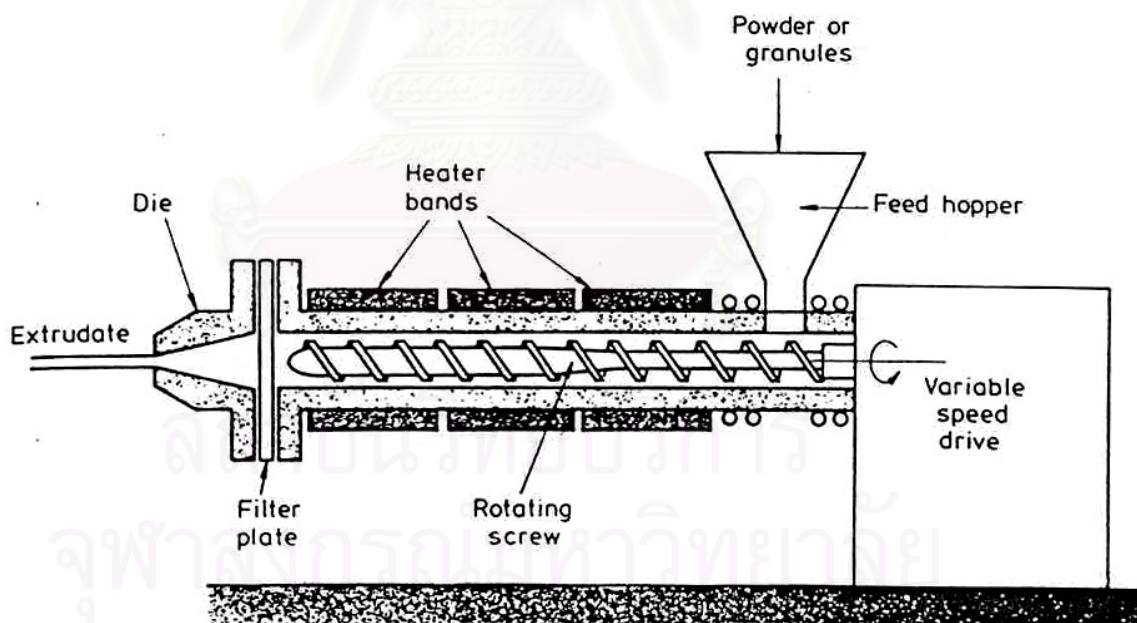

Figure 3-8 Schematic view of single screw extruder. [Crawford, 1987]

Basically an extruder screw has three different zones.

(a) Feed Zone The function of this zone is to preheat the plastic and convey it to the subsequent zones. The design of this section is important since the constant screw depth must supply sufficient material to the metering zone so as not to starve it, but on the other hand not supply so much material that the metering zone is overrun. The optimum design is related to the nature and shape of the feedstock, the geometry of the screw and the frictional properties of the screw and barrel in relation to the plastic. The frictional behavior of the feed-stock material has a considerable influence on the rate of melting which can be achieved.

(b) Compression Zone In this zone the screw depth gradually decreases so as to compact the plastic. This compaction has the dual role of squeezing any trapped air pockets back into the feed zone and improving the heat transfer through the reduced thickness of material.

(c) Metering Zone In this section the screw depth is again constant but much less than the feed zone. In the metering zone the melt is homogenised so as to supply at a constant rate, material of uniform temperature and pressure to the die. This zone is the most straight-forward to analyse since it involves a viscous melt flowing along a uniform channel.

The pressure build-up which occurs along a screw is illustrated in **Figure 3-9**. The lengths of the zones on a particular screw depend on the material to be extruded. With nylon, for example, melting takes place quickly so that the compression of the melt can be performed in one pitch of the screw. PVC on the other hand is very heat sensitive and so a compression zone which covers the whole length of the screw is preferred.

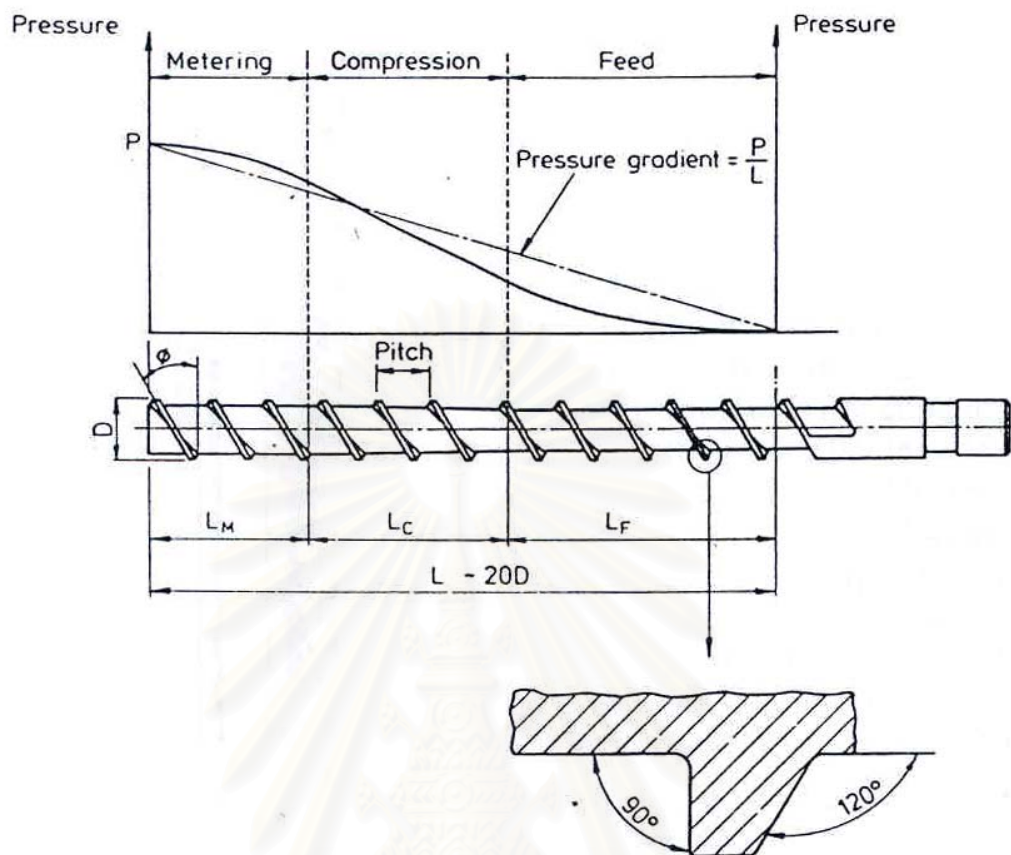

Figure 3-9 Typical zone on an extruder screw. [Crawford, 1987]

3.3.2 General Features of Twin Screw Extruders

In recent years there has been a steady increase in the use of extruders which have two screws rotating in a heated barrel. These machines permit a wider range of possibilities in terms of output rates, mixing efficiency, heat generation, etc compared with a single screw extruder. Although the term "twin screw" is used almost universally for extruders having two screws, the screws need not be identical. There are in fact a large variety of machine types. Figure 3-10 illustrates some of the possibilities with counter-rotating and co-rotating screws. In addition the screws may be conjugated or non-conjugated. A non-conjugated screw configuration is one in which the screw flights are a loose fit into one another so that there is ample space for material between the screw flights.

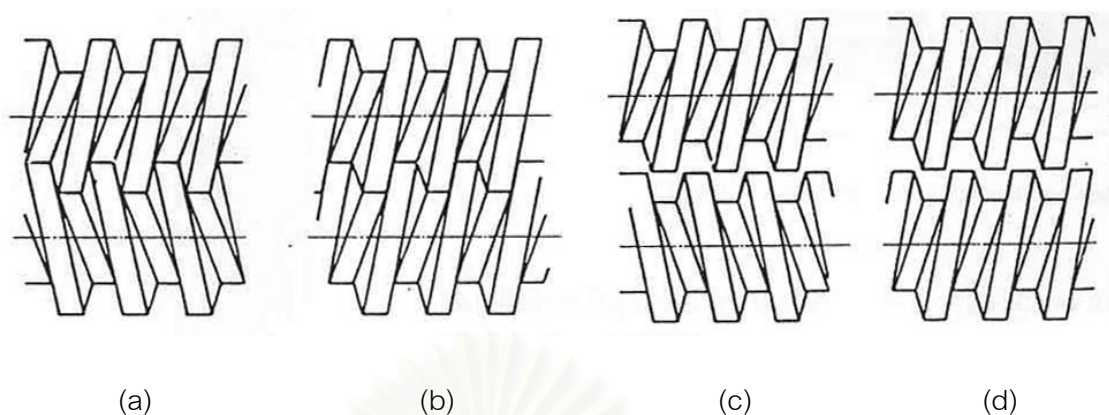

Figure 3-10 Different types of twin screw extruder (a) counter-rotating (intermeshing), (b) co-rotating (intermeshing), (c) counter-rotating (non-intermeshing), (d) co-rotating (non-intermeshing). [Crawford, 1987]

In a counter-rotating twin screw extruder the material is sheared and pressurised in a mechanism similar to calendering, i.e. the material is effectively squeezed between counter-rotating rolls. In a co-rotating system the material is transferred from one screw to the other. This type of arrangement is particularly suitable for heat sensitive materials because the material is conveyed through the extruder quickly with little possibility of entrapment. The movement around the screw is slower if the screws are conjugated but the propulsive action is greater.

3.4 Injection Moulding

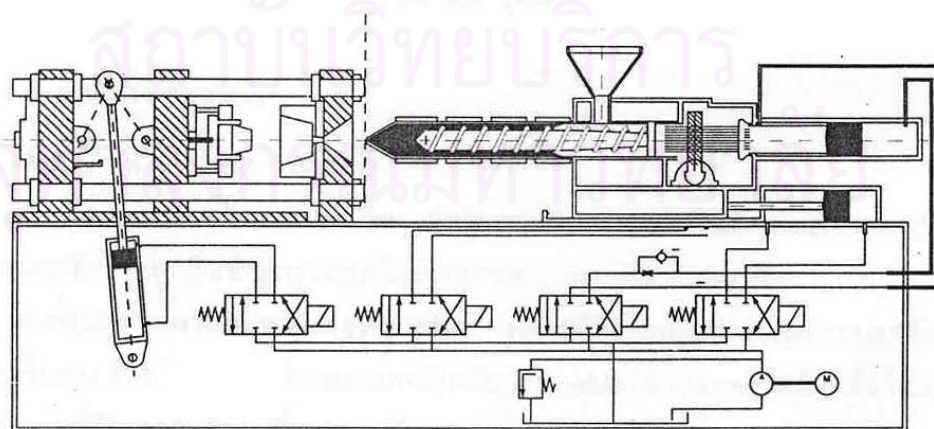

Figure 3-11 Schematic view of injection moulding machine. [Crawford, 1987]

The original injection moulding machines were based on the pressure die casting technique for metals. The first machine is reported to have been patented in the United States in 1872, specifically for use with Celluloid. This was an important invention but probably before its time because in the following years very few developments in injection moulding processes were reported and it was not until the 1920s, in Germany, that a renewed interest was taken in the process. The first German machines were very simple pieces of equipment and relied totally on manual operation. Levers were used to clamp the mould and inject the melted plastic with the result that the pressures which could be attained were not very high. Subsequent improvements led to the use of pneumatic cylinders for clamping the injection which not only lifted some of the burden off the operator but also meant that higher pressures could be used.

The next major development in injection moulding, i.e. the introduction of hydraulically operated machines, did not occur until the late 1930s when a wide range of thermoplastics started to become available. However, these machines still tended to be hybrids based on die casting technology and the design of injection moulding machines for plastics was not taken really seriously until the 1950s when a new generation of equipment was developed. These machines catered more closely for the particular properties of polymer melts and modern machines are of the same basic design although of course the control systems are very much more sophisticated nowadays.

In principle, injection moulding is a simple process. A thermoplastic, in the form of granules or powder, passes from a feed hopper into the barrel where it is heated so that it becomes soft. It is then forced through a nozzle into a relatively cold mould which is clamped tightly closed. When the plastic has had sufficient time to become solid the mould opens, the article is ejected and the cycle is repeated. The major advantages of the process include its versatility in moulding a wide range of products, the ease with which automation can be introduced, the possibility of high production rates and the manufacture of articles with close tolerances. The basic injection moulding concept can also be adapted for use with thermosetting materials.

3.5 Rheology

3.5.1 Introduction

The flow behavior of polymer melts is of great practical importance in polymer manufacturing and polymer processing. Therefore the development of a quantitative description of flow phenomena on the basis of a number of material properties and process parameters is highly desirable.

In the same way as the mechanical behavior of solid polymers can be described in terms of *moduli* (ratios of stress and deformation), the flow behavior of polymer melts can be characterized by *viscosities* (ratios of stress and *rate* of deformation)

For common liquids the viscosity is a material constant which is only dependent on temperature and pressure but not on rate of deformation and time. For polymeric liquids the situation is much more complicated: viscosities differ with deformation conditions. Furthermore the flow of polymeric melts is accompanied by elastics, due to which part of the energy exerted on the system is in form of stored recoverable energy. For this reason the viscosities are rate dependent: polymer melts are viscoelastic.

3.5.2 Flow Classification

There are two prominent elementary modes of deformation, simple shear and simple extension. Simple shear flow could be of the steady or unsteady type. Thus, flow is classified here under three headings.

3.5.2.1 Steady Simple Shear Flow

Under idealized conditions the polymer melt subjected to simple shear is contained between two (infinitely extending) parallel walls, one of which is translated parallel to the other at a constant distance. The result of the shear stress (τ , the force exerted on the moving wall per unit of surface area) is a velocity gradient in the melt in a direction perpendicular to the wall. Under these ideal conditions the velocity profile is linear, so that the gradient ($dU/dx = \dot{\gamma}$, also called rate of shear) is constant. The shear viscosity is obtained as the ratio between shear stress and rate of shear.

Although the geometry of simple shear as defined above is seldom encountered in practice, it may be approximated under real conditions. So the technically important case of laminar or Poiseuille flow through cylindrical tubes under ideal conditions are simple shear flow. This and other types of flow geometry are reproduced in Figure 3-12.

1. Poiseuille Flow

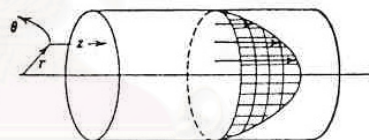

2. Couette Flow

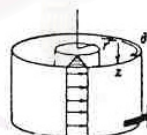

3. Parallel Plate Torsion

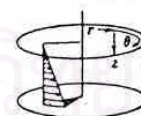

4. Cone and Plate Torsion

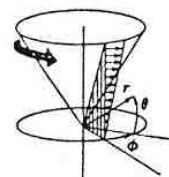

Figure 3-12 Type of steady simple shear flow. [Krevelen, 2000]

Shear viscosity (η)

$$\eta = \frac{\text{shear stress}}{\text{shear rate}} = \frac{\text{shear component in the direction of shear deformation}}{\text{velocity gradient perpendicular to the direction of shear deformation}}$$

or

$$\eta = \frac{\tau}{\frac{d\mathbf{v}}{dx}} = \frac{\tau}{\dot{\gamma}} \quad (3.1)$$

For ordinary liquids is a constant; such a behavior is called Newtonian. At very low rates of deformation polymeric melts also show Newtonian behavior. In this case the shear viscosity will be characterized by the symbol η_0 .

As a matter of fact $\eta_0 = \lim_{\dot{\gamma} \rightarrow 0} \eta(\dot{\gamma})$ (3.2)

3.5.2.2 Unsteady Simple Shear Flow

Unsteady simple shear flow would occur when the stresses involved are time dependent. Small-amplitude oscillatory flow is often referred to as dynamic shear flow. Shear rate, $\dot{\gamma}$ is not a constant as in steady simple shear, it varies sinusoidally and is given by

$$\dot{\gamma}(t) = \dot{\gamma}_0 \cos \omega t \quad (3.3)$$

The shear stress in simple dynamic shear flow is expressed in terms of the amplitude and phase shift functions of the frequency as

$$\tau_{21}(t) = \dot{\gamma}_0 [G'(\omega) \sin \omega t + G''(\omega) \cos \omega t] \quad (3.4)$$

$$= \tau_{21}^0 \sin(\omega t + \delta) \quad (3.5)$$

where δ is the phase angle, $\dot{\gamma}_0$ and τ_{21}^0 are the amplitude of the strain and stress, respectively, and G' , G'' are linear viscoelastic material functions, referred to as the dynamic storage modulus and dynamic loss modulus respectively.

$$\text{Dynamic storage modulus: } G'(\omega) = \frac{\tau_{21}^0}{\dot{\gamma}_0} \cos\delta \quad (3.6)$$

$$\text{Dynamic loss modulus: } G''(\omega) = \frac{\tau_{21}^0}{\dot{\gamma}_0} \sin\delta \quad (3.7)$$

Another term of importance is the ratio of loss to storage modulus, defined as

$$\text{Loss tangent: } \frac{G''(\omega)}{G'(\omega)} = \tan\delta \quad (3.8)$$

It is also possible to define a dynamic complex viscosity in term of G' , G'' as follows:

$$\text{Dynamic viscosity: } \eta'(\omega) = \frac{G''(\omega)}{\omega} \quad (3.9)$$

$$\text{Imaginary part of the complex viscosity: } \eta''(\omega) = \frac{G'(\omega)}{\omega} \quad (3.10)$$

$$\text{Complex viscosity function: } \eta^*(i\omega) = \eta'(\omega) - i\eta''(\omega) \quad (3.11)$$

In the same manner as above, a complex modulus can be defined as

$$\text{Complex modulus: } G^*(i\omega) = G'(\omega) - iG''(\omega) \quad (3.12)$$

The storage modulus (G') and the imaginary part of the complex viscosity (η'') are to be considered as the elastic contributions to the complex functions. They are both

measures of energy storage. Similarly, the loss modulus (G'') and the dynamic viscosity (η') are the viscous contributions or measures of energy dissipation.

3.5.2.3 Simple extension

In this case a cylindrical rod of polymer is subjected to extension in axial direction under the influence of a tensile stress (in the same direction) which is constant over the cross section. The rate of extension is measured and the tensile viscosity is obtained as the ratio between tensile stress and rate of extension.

In practice, simple extension is found in melt spinning of polymeric fibres, although the situation is complicated by the non-isothermal character.

Extensional viscosity (λ)

$$\lambda = \frac{\text{tensile stress}}{\text{rate of extension}} = \frac{\text{stress component in the direction of tensile deformation}}{\text{rate of relative increase of length}}$$

or

$$\lambda = \frac{\sigma}{\frac{1}{L} \frac{dL}{dt}} = \frac{\sigma}{\dot{\epsilon}} \quad (3.13)$$

where the extension $\epsilon = \ln(L/L_0)$ (3.14)

$$\text{rate of extension } \dot{\epsilon} = \frac{d\epsilon}{dt} = \frac{1}{L} \frac{dL}{dt} \quad (3.15)$$

Also in this case we have :

$$\lambda_0 = \lim_{\dot{\epsilon} \rightarrow 0} \lambda(\dot{\epsilon}) \quad (3.16)$$

3.5.3 Description of non-Newtonian fluid behavior in shear

If the viscosity is independent of the rate of shear, the liquid is said to be Newtonian or to exhibit ideal flow behavior. But it is well known that liquids with complex structure, and suspensions behave in unexpected ways and are not described by the constitutive equation for Newtonian liquids.

Non-Newtonian fluids are usually considered to be those for which the relation connecting shear stress and shear rate is not linear, that is, the viscosity of non-Newtonian fluid is not constant at a given temperature and pressure but depends on the rate of shear or more generally, on the previous kinematics history of the fluid. Non-linear fluid in shear flow may be classified into three broad types:

- (a) Fluids for which the rate of shear at any point is some function of the shear stress at that point and depends on nothing else; (time-independent fluids);
- (b) More complex systems for which the relation between shear stress and shear rate depends on the time the fluid has been sheared; (time-dependent fluids);
- (c) Systems which have characteristics of both solids and fluids and exhibit partial elastic recovery after deformation; these are called viscoelastic fluids.

These three classes of fluids will now be considered; in all cases we shall suppose that the sample is small enough so that the sample inertia can be ignored.

3.5.3.1 Time-independent non-Newtonian fluids

Fluid of the first type whose properties are independent of time may be described, in a simple shearing experiment, where the only velocity component u is in the x -direction and all velocity variation is in the y -direction, by a rheological equation of the form (3.17)

$$\frac{du}{dy} = \dot{\gamma} = f(\tau) \quad (3.17)$$

This equation implies that the rate of shear ($\dot{\gamma}$) at any point in the fluid is a function of the shear stress (τ) at that point. Such fluids may be termed non-Newtonian viscous fluids, or generalized Newtonian fluids.

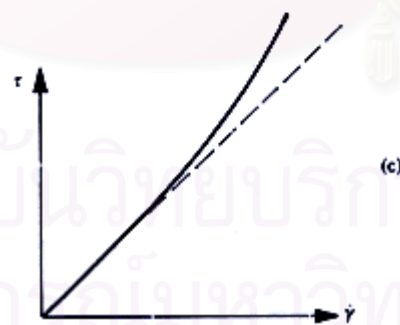
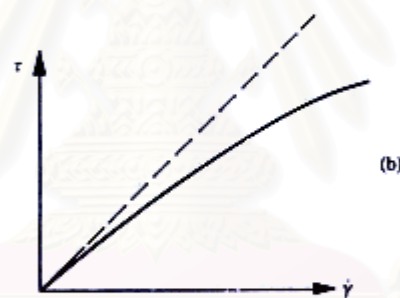
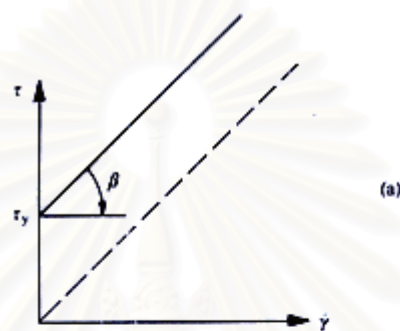

Figure 3-13 Shear stress vs. shear rate for (a) Bingham plastic (b) Pseudo-plastic fluid (c) Dilatant fluid. [Tanner, 1988]

These fluids may conveniently be subdivided into three distinct types depending on the nature of the function in equation (1.4). These types are

(a) *Bingham plastics.*

A Bingham plastic is characterized by a flow curve which is a straight line having an intercept τ_y on the shear-stress axis. The yield stress, τ_y , is the magnitude of the stress which must be exceeded before flow starts.

The concept of an idealized Bingham plastic is convenient in practice because some fluids approximate this type of behavior more or less closely. Common examples are slurries, drilling muds, greases, toothpaste, and sludges. The explanation of Bingham plastic behavior is that the fluid at rest contains a three-dimensional structure of sufficient rigidity to resist any stress less than the yield stress, τ_y . If this stress is exceeded the structure disintegrates and the system behaves as a Newtonian fluid under a shear stress $\tau - \tau_y$; when the shear stress falls below τ_y the structure is reformed.

(b) *Pseudo-plastic fluids.*

Pseudo-plastic fluids show no yield value and the typical flow curve for these materials indicates that the ratio of shear stress to the rate of shear, which is termed the viscosity, fall progressively with shear rate and the flow curve become linear only at very high rates of shear. This limiting slope is known as the viscosity at infinite shear and is designated η_∞ . The logarithmic plot of shear stress and rate of shear for these materials is often found to be linear with a slope between zero and unity.

This type of behavior is characteristic of high polymer, polymer solution and many suspensions. One physical interpretation of this phenomenon is that with increasing rates of shear the molecules (or the structure) are progressively aligned. Instead of the random intermingled state which exists when the fluid is at rest the major axes are brought into line with the direction of flow and the viscosity decreases.

(c) *Dilatant fluids.*

Dilatant fluids are similar to pseudo-plastics in that they show no yield stress but the viscosity for these materials increases with increasing rates of shear. This type of behavior was originally discussed in connection with concentrated suspensions of solids. That when these concentrated suspensions are at rest, the voidage is at a minimum and the liquid is only sufficient to fill the voids. When these materials are sheared at low rates, the liquid lubricates the motion of one particle past another and the stresses are consequently small. At higher rates of shear the dense packing of the particles is broken up and the material expands or 'dilates' slightly and the voidage increases. There is now insufficient liquid in the new structure to lubricate the flow of the particles past each other and the applied stresses have to be much greater. The formation of this structure causes the viscosity to increase rapidly with increasing rates of shear.

3.5.3.2 *Time-dependent non-Newtonian fluids*

Many real fluids cannot be described by simple rheology equation. The viscosity of more complex fluids depends not only on the rate of shear but also on the time the (constant) shearing has been applied. These fluids may be subdivided into two classes.

(a) *Thixotropic fluids*

Thixotropic materials are those whose consistency depends on the duration of shear as well as on the rate of shear. If a thixotropic material is sheared at a constant rate after a period of rest, the structure will be progressively broken down and the viscosity will decrease with time. The rate of breakdown of structure during shearing at a given rate will depend on the number of structural linkages available for breaking and must therefore decrease with time. The simultaneous rate of reformation of structure

will increase with time as the number of possible new linkages increase. Eventually a state of dynamic equilibrium may be reached when the rate of build-up of structure equals the rate of breakdown.

(b) *Rheopectic fluids*

This is a case of gradual formation of structure by shear, whereas so far the properties of structured materials have been explained on the basis that shearing tends to destroy structure. There are often a critical amount of shear beyond which reformation of structure is not induced and breakdown occurs. This behavior is observed with dilute aqueous solutions of vanadium pentoxide and bentonite. Consider the flow of this material through a capillary tube. At a moderate pressure difference the flow is rapid at first and then decreases as the structure builds up. At a high pressure difference the flow is always rapid and does not fall off because the structure does not build up at high rates of shear.

3.5.3.3 *Viscoelastic materials*

In the classical linearized theory of elasticity, the stress in a sheared body is taken to be proportional to the amount of shear. In a Newtonian fluid the shearing stress is proportional to the rate of shear. In most materials, under appropriate circumstances, effects of both elasticity and viscosity are noticeable. If these effects are not further complicated by the time-dependent behavior mentioned above, we call the material 'viscoelastic'.

From the broader and more unified point of view that the theory of viscoelasticity affords, we will be able to see that perfectly elastic deformation and perfectly viscous flow are idealizations that are approximately realized in some limiting conditions. In describing the behavior of materials mathematically, we use idealizations that depend strongly on the circumstances to be described, and not only on the nature

of the material; thus will find that the distinction between 'solid' and 'fluid' and between 'elastic' and 'viscous' are not absolute distinctions between type of materials.

3.6 Rheological Measurements

3.6.1 Parallel Plate

The parallel plate geometry was suggested by Mooney (1934). The Mooney tester, which consists of a disk rotating inside a cylindrical cavity, is used extensively in the rubber industry (ASTM D 1646). Russell (1946) first measured normal forces from the total thrust between two disks. Greensmith and Rivlin (1953) measured the pressure distribution, and Kotaka et al. (1959) used total thrust to study normal stresses in polymer melts. In many ways the flow is similar to the cone and plate. Most instruments are designed to permit the use of either geometry.

Errors

- Inertia and secondary flow.
- Edge failure (same as cone and plate).
- Shear heating.
- Nonhomogeneous strain field (correctable).

Utilities

- Sample preparation and loading is simpler for very viscous materials and soft solid.
- Can vary shear rate (and shear strain) independently by rotation rate Ω (and θ) or by changing gap h : permits increased range with a given experimental setup.
- Determine wall slip by checking measurement at two gaps.
- Delay edge failure to higher shear rate by decreasing gap during an experiment.

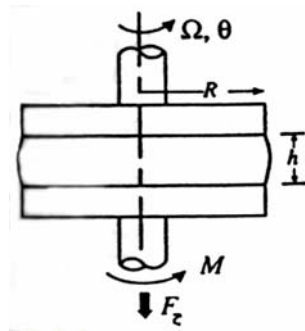

Figure 3-14 Schematic of a parallel plate rheometer. [Macosko, 1994]

The parallel plate geometry is sketched in Figure 3-14. If we assume:

1. Steady, laminar, isothermal flow
2. $\mathbf{V}_\theta(r, z)$ only, $\mathbf{V}_r = \mathbf{V}_z = 0$
3. Negligible body forces
4. Cylindrical edge

Then the equations of motion reduce to

$$\theta : \frac{\partial \tau_{\theta z}}{\partial z} = 0 \quad (3.18)$$

$$z : \frac{\partial \tau_{zz}}{\partial z} = 0 \quad (3.19)$$

$$r : \frac{1}{r} \frac{\partial}{\partial r} (r \tau_{rr}) - \frac{\tau_{\theta\theta}}{r} = -\rho \frac{v_\theta^2}{r} \quad (3.20)$$

With one disk stationary and the other rotating at Ω , assuming no slip at these surfaces and neglecting inertial forces, the velocity must be

$$v_\theta(r, z) = \frac{r\Omega z}{h}$$

And thus

$$\dot{\gamma}(r) = \frac{r\Omega}{h} \quad (3.21)$$

Similarly the strain goes from zero at the center to maximum at the edge

$$\gamma = \frac{\theta r}{h} \quad (3.22)$$

As in wide gap Couette and Poiseuille flow, shear rate is not constant. Thus we must use a derivative to relate shear stress to total torque. The resulting equations are given below and then derived in the remainder of this section.

From eq. 3.18 and recalling that the shear stress can be a function of shear rate alone, $\tau_{\theta z} = \tau_{12} = \tau_{12}(\dot{\gamma})$. From a torque balance

$$M = 2\pi \int_0^R r \tau_{12}(r) r dr \quad (3.23)$$

Changing variables, we have

$$r = \frac{h}{\Omega} \dot{\gamma} = \frac{R\dot{\gamma}}{\dot{\gamma}_R} \quad \text{where} \quad \dot{\gamma}_R = \frac{\Omega R}{h}$$

$$dr = \frac{R}{\dot{\gamma}_R} d\dot{\gamma}$$

Then

$$M = 2\pi \int_0^{\dot{\gamma}_R} \left(\frac{R}{\dot{\gamma}_R} \right)^3 \dot{\gamma}^2 \tau_{12} d\dot{\gamma} \quad (3.24)$$

Rearranging and differentiating using Leibnitz's rule gives

$$\tau_{12}(R) = \frac{M}{2\pi R^3} \left[3 + \frac{d \ln M}{d \ln \dot{\gamma}_R} \right] \quad (3.25)$$

Thus to evaluate shear stress for an unknown fluid, a sufficient amount of $\ln M$ versus $\ln \dot{\gamma}_R$ data must be taken to determine the derivative accurately. In practice this is not highly difficult, since many materials have power law regions and numerical software packages are readily available for handling the data. Furthermore, the derivative is generally less than 1, and thus a 10% error results in less than 3% error in τ_{12}

If the test liquid is Newtonian, $d \ln M/d \ln \dot{\gamma}_R = 1.0$ and the shear stress becomes

$$\tau_a(R) = \frac{2M}{\pi R^3} \quad (3.26)$$

This apparent shear stress often is used to calculate an apparent viscosity, since only a single torque measurement is required. However, a simple, approximate single point method was developed by Geisekus and Langer (1977). It is similar to the method for approximating true shear rate in a capillary rheometer. Here the idea is that the true and apparent shear stresses must be equal at some radial position. This occurs at nearly the same point, $r/R = 0.76$, for a wide range of liquids, i.e. those for which $d \ln M/d \ln \dot{\gamma}_R < 1.4$. Thus the true viscosity is equal to the apparent viscosity evaluated at

$$\eta(\tau) = \eta_a(\tau_a) \pm 2\% \text{ for } \tau = 0.76\tau_a \quad (3.27)$$

It is easier to load and unload viscous or soft solid samples with the parallel disk geometry than with cone and plate or concentric cylinders. Thus parallel

disks are usually preferred for measuring viscoelastic material function like, $G(t, \gamma)$. $G'(\omega)$. or $J(t, \tau)$ on polymer melts. To evaluate moduli or compliance, we use the strain and stress at the edge of the disk (eqs. 5.5.5 and 5.5.8). but now the stress must be corrected by $d \ln M/d \ln \gamma$ (Soskey and Winter, 1984). In the linear viscoelastic region $G(t, \gamma) = G(t)$ and $d \ln M/d \ln \gamma = 1$.

The parallel disk rheometer is also very useful for obtaining viscosity and normal stress data at high shear rates. Shear rate can be increased by either increasing rotation rate or decreasing gap. Errors due to secondary flows, edge effects, and shear heating are all reduced by operating at small gaps. Binding and Walters (1976) report reaching 10^5 s^{-1} with $h = 3.2 \mu\text{m}$. Connelly and Greener (1985) and Kramer et al. (1985) report that below about $300 \mu\text{m}$. they needed to correct for an error in the measured gap. A simple constant error term ($h_e = 10$ to $40 \mu\text{m}$.) was found adequate: that is, for a Newtonian liquid the relation.

$$\frac{\dot{\gamma}_h h}{\tau_R} = \frac{h}{\eta} + \frac{h_e}{\eta} \quad (3.28)$$

Fit their data in which $\dot{\gamma}_h h$ is the apparent shear rate calculated at the measured gap.

Another use for data collected at different gaps in the parallel disk geometry is in determining wall slip. Yoshimura and Prud'homme (1988) have shown that the difference in apparent stress versus shear rate at two different gaps can be related to wall slip.

Vrentas et al. (1991) have analyzed the effect on the torque of using a cup instead of the lower disk. The flow extends out into the surrounding fluid. For small gaps and large cups $R_{cup}/R > 1.1$. the effect of the cup radius can be ignored if $R/R_{cup} > 1.1$. Then the extra torque depends solely on the ratio of gap to radius

$$\frac{M}{M_0} = 1 + 1.9 \frac{h}{R} \quad (3.29)$$

The normal stresses arise from eq. 3.20. Neglecting the inertial term and noting that

$$\frac{d\tau_{22}}{dr} = \frac{d\tau_{33}}{dr} + \frac{d}{dr}(\tau_{22} - \tau_{33})$$

$$\frac{d\tau_{22}}{dr} = -\frac{\tau_{33} - \tau_{11}}{r} + \frac{d}{dr}(\tau_{22} - \tau_{33}) \quad (3.30)$$

Integrating from r to R

$$\int_{\tau_{22}(r)}^{\tau_{22}(R)} d\tau_{22} = \int_{N_2(r)}^{N_2(R)} d(\tau_{22} - \tau_{33}) + \int_r^R \frac{N_1 + N_2}{\zeta} d\zeta$$

gives, after substituting for N_1 and N_2 ,

$$\tau_{22}(r) = N_2(r) + \int_r^R \frac{N_1 + N_2}{\zeta} d\zeta \quad (3.31)$$

More frequently, total thrust is measured. Integrating eq. 3.27 for F_z gives

$$F_z = -2\pi \int_0^R N_2 r dr + 2\pi \int_0^R \frac{N_1 + N_2}{\zeta} \left(\int_r^R d\zeta \right) r dr \quad (3.32)$$

If we are careful about the limits of integration, we can change the order to give

$$F_z = -2\pi \int_0^R N_2 r dr + 2\pi \int_0^R \frac{N_1 + N_2}{\zeta} \int_0^\zeta r dr d\zeta$$

$$= -\pi \int_0^R (N_1 - N_2) r dr \quad (3.33)$$

Changing variables again by eq. 3.23 and differentiating with respect to $\dot{\gamma}_R$ we obtain

$$\frac{2\dot{\gamma}_R F_z}{\pi R^2} + \frac{\dot{\gamma}_R^2}{\pi R^2} \frac{dF_z}{d\dot{\gamma}_R} = \dot{\gamma}_R (N_1 - N_2)$$

or

$$(N_1 - N_2) \dot{\gamma}_R = \frac{F_z}{\pi R^2} \left[2 + \frac{d \ln F_z}{d \ln \dot{\gamma}_R} \right] \quad (3.34)$$

Eccentricities or misalignments are not as important except for very narrow gaps. One advantage of the parallel disk system is that the shear rate can readily be changed by both Ω and h . Broyer and Macosko (1975) have used small h values to delay edge failure effects to higher shear rates than can be achieved in typical cone and plate geometries.

3.6.2 Melt Index

The most common capillary instrument in the polymer industry is not a rheometer but an indexer. The quality of nearly every batch of thermoplastic made in the world is controlled by melt index. Because it is so widely used and has all the essential features of a capillary rheometer, and because rheologists are often asked to compare their results to melt index values, we need to examine it here.

The melt index is standardized internationally, (ISO R1133; R292) in the United States, Germany, Japan (e.g., ASTM D1238, DIN 53735, JIS K7210) and in other countries. **Figure 3-15** shows the measuring apparatus. It resembles a typical capillary for polymer melts except that only one die and one driving pressure are specified to give the melt index number. The die has a rather large diameter, $2R = 2.095$ mm, and is short, $L/R = 7.637$. There are a number of different load and temperature conditions, depending on the particular polymer.

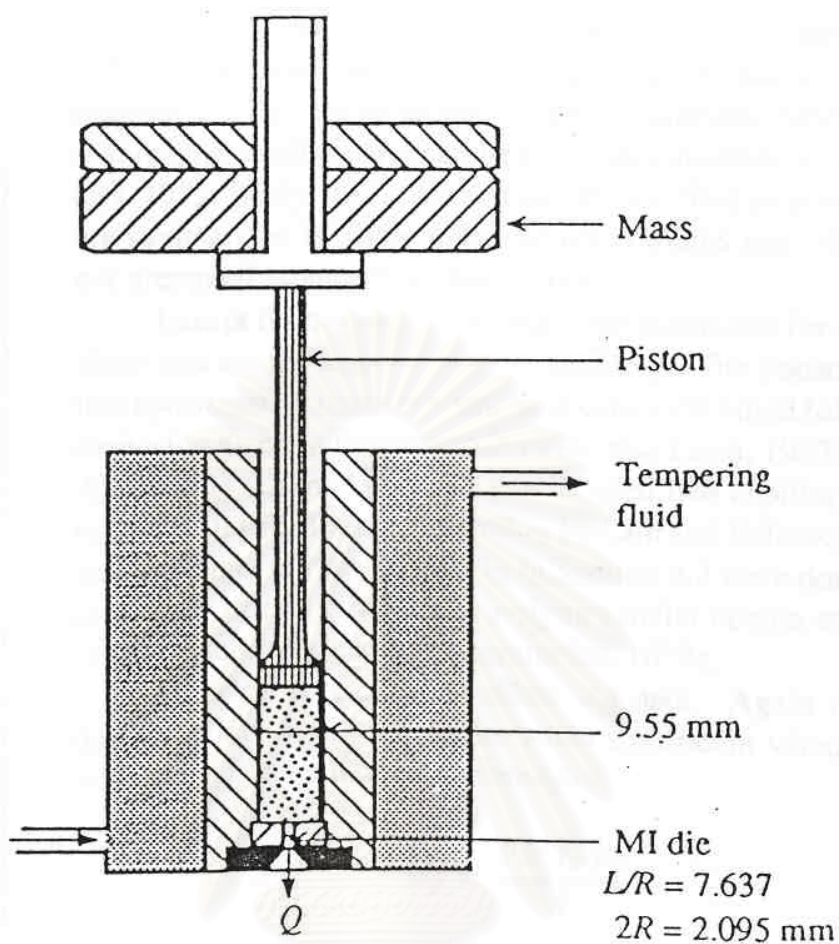

Figure 3-15 Schematic of melt index apparatus. [Crawford, 1987]

After the sample is heated to set temperature, the weight is applied and flow rate is determined by cutting and weighing the extrudate obtained in 10 minutes. This weight in grams is the melt flow index (MFI) of the polymer. It resembles an inverse viscosity at moderately low stress. High MFI means low η_0 and low molecular weight, hence its use to control polymerization reactors (Bremner and Rudin, 1990).

3.7 Rheological Models

3.7.1 Power Law Model

The simplest empiricism for $\eta(\dot{\gamma})$ is the two parameter power law expression:

$$\eta = m\dot{\gamma}^{n-1} \quad (3.35)$$

In which m and n are constants characterizing the fluid. This simple relation describes the non-Newtonian viscosity curve over the portion of the log-log plot of the viscosity versus shear rate for many materials. This equation is most often applied to steady simple shear flow.

3.7.2 Cox and Mertz Method

Cox and Mertz method is relating steady shear viscosity with the absolute value of complex viscosity:

$$\eta(\dot{\gamma}) = |\eta^*(\omega)| \quad \text{at } \dot{\gamma} = \omega \quad (3.36)$$

The relationship simply indicates that complex viscosity is equal to the steady-shear viscosity or zero-shear over a small range of shear rate or frequency. This relationship has been found to hold largely for flexible chain thermoplastic melts.

3.7.3 Giesekus Model

Material Functions for small amplitude oscillatory shear flow:

$$\frac{\eta'}{\eta_0} = \frac{1}{1 + (\lambda\omega)^2} \quad \text{and} \quad \frac{\eta''}{\eta_0} = \frac{\lambda\omega}{1 + (\lambda\omega)^2} \quad (3.37)$$

This model has been used widely for fluid dynamics calculations. Superpositions of Giesekus models can be made to describe the shapes of the measured material functions over small range of angular frequency.



สถาบันวิทยบริการ
จุฬาลงกรณ์มหาวิทยาลัย

Chapter 4

Experiments

4.1 Materials

4.1.1 Poly (bisphenol A carbonate), PC

There were two different molecular weights of poly (bisphenol A carbonate), PC, used in this work. Commercial grades PC were provided from Bayer Polymer Co., Ltd in the trade name of “Markrolon 2600” and “Markrolon 2405” and were noted as PC-2600 and PC-2405 respectively. The melt flow indices are 19.9 and 23.1 g/10min (300^oC / 2.16kg.). The average molecular weights of these polymers are 43,493 and 35,806 as determined by Gel Permeation Chromatography. The glass transition temperature (T_g) of PC-2600 is approximately at 150^oC and the approximate processing temperature of the Polycarbonate is approximately at 230^oC

4.1.2 Additives

4.1.2.1 Cyclohexylbiphenylcyclohexane, CBC33

Cyclohexylbiphenylcyclohexane, CBC33, is the low molar mass thermotropic liquid crystal that was used in this work and manufactured by MERCK Co., Ltd. The molecular weight of CBC33 is 402.67. The melting temperature(T_m) of CBC33 is at 158^oC, Smectic to Nematic transition temperature is at 223^oC and the clearing temperature is at 327^oC

4.1.2.2 Glycerol monostearate, GMS

Glycerol monostearate, GMS is in the form of ivory white beads as received. It was manufactured by RIKEVITA (Malaysia) SDN. BHD. It can be used as an additive for internal lubricant and as an anti-static agent in various polymers. The molecular weight of GMS is 361. The melting temperature(T_m) of GMS is at 65^oC.

4.2 Equipment

4.2.1 Digital Hot Plate Stirrer

A Cole-Parmer digital hot plate stirrer was used for mixing the polymers with additives. This hot plate stirrer is programmable. All functions can be set from digital panel and display their status on LCD. The plate temperature, stirrer speed and time are controllable.

4.2.2 Single Screw Extruder

A Haake single screw extruder model Rheocord R252 was used in these experiments. The L/D of the extruder is 25:1, with a compression ratio of 3:1 and screw of diameter 19.0 mm. Die type is rod die with a diameter of 3 mm. The maximum operating temperature is 480°C, maximum torque is 160 Nm, maximum pressure is 500 bar and maximum capacity is 30 kg/h. The temperatures, screw speed and other conditions could be directly controlled by computerized system.

4.2.3 Twin Screw Extruder

A Haake twin screw extruder model Rheomex CTW100p was used in these experiments. The extruder is counter rotating type with three heating zone and the L/D is 15:1 and screw diameter of 20 mm. Die type is multistrand with die diameter of 3 mm. The maximum operating temperature is 480°C, maximum torque is 200 Nm and maximum pressure is 700 bar. The temperatures, screw speed and other conditions could be directly controlled by computerized system.

4.2.4 Injection Molding Machine

A BOY injection molding machine model 22M was used in these experiments. This machine is single screw with four heating zone and the L/D is 17:1 with screw diameter of 24 mm and maximum clamping force is 220 kN. All functions can be set from digital panel and display their status on monitor.

4.2.5 Hydraulic Hot Press

A local made hydraulic hot press was used in these experiments. The maximum working temperature of this machine is 600°C and the maximum pressure is 5,000 psi. This equipment is needed for preparing the sample for rheology test.

4.2.6 Parallel Plate Rheometer

A Haake rheometer model RS75 was taken to investigate the shear viscosity and complex viscosity of samples. The parallel plate sensor with both plate diameter of 20 mm. was used. To set of equipment compounded with rheometer, temperature controller, air compressor which are connected with a computer. All conditions could be directly controlled by computerized system.

4.2.7 Melt Flow Index Test Machine

A CEAST melt flow index test machine was used in these experiments. Die diameter is 2.095 mm. with a height of 8.000 mm. The maximum operating temperature is 400 °C, maximum load is 5 kg. The temperature and cutter speed are controllable.

4.3 Mixing and Sample Preparation

4.3.1 Stirring melt mix

4.3.1.1 Masterbatch preparation

The mixtures of PC-2600 and additives were pre-blended at about 10% weight of additive by melted mixed with 20 g of polycarbonate. 20 g of polycarbonate (PC-2600 or PC-2405) were preheated and melt at 290°C on programable hot stage for about 10 mins. The additive (CBE53 or GMS) was added and thoroughly stirred with polycarbonate at 290°C. Each mixture was pressed to about 0.5 mm thin film and further cut into pieces that have similar size of the pellets.

4.3.1.2 Mixing of PC-2600 and PC-2405 with GMS

The blend of PC-2600 and GMS were prepared by using a digital hot plate stirrer at the composition 0.1, 0.2, 0.4, 0.8 and 1 percent by weight of GMS. PC-2600 and PC-2405 were weighed in a beaker about 20 g. and GMS was weighed corresponding to the desired compositions. Each sample was placed on Teflon sheet and placed on the digital hot plate stirrer. The hot plate was set at 290^oC and mixed together for 10 minutes in order to have a uniform mixture. After that, the mixture was cut into small pellets. PC-2405 and GMS mixed were prepared in the same way as a mixture of PC-2600 and GMS.

4.3.1.3 Mixing of PC-2600 and PC-2405 with CBC33

The blend of PC-2600 and CBC33 were prepared by using a digital hot plate stirrer at the composition 0.1, 0.2, 0.4, 0.8 and 1 percent by weight of CBC33. PC-2600 and PC-2405 were weighed in a beaker about 20 g. and CBC33 was weighed corresponding to the desired compositions. Each sample was placed on Teflon placed on the digital hot plate stirrer. The hot plate was set at 290^oC and the melted polymer mixed together for 10 minutes in order to have a uniform mixture. After that, the mixture was cut into small pellets. The blend of PC-2405 and CBC33 were prepared in the same way as a mixture of PC-2600 and CBC 33.

4.3.2 Mixing by the single screw extruder

The mixture of PC-2600 and CBC33 were prepared by using the HAAKE single screw extruder. The mixture concentration was 0.2 percent by weight of CBC33. The polycarbonate and the masterbatch were weighed to control percent of additive, dried and mixed before feeding into the hopper of the extruder. The temperatures at three heating zones were maintained constant at 260^oC, 270^oC and 280^oC with die temperature was 280^oC (the lowest temperature that can used for mixing). Screw speed was 20 rpm and cooling water temperature was 35^oC. The mixtures of PC-2405 and CBC33 were prepared in the same way as the mixture of PC-2600 and CBC33. Pure PC-

2600 and pure PC-2405 were similarly prepared in order to have the same thermal history. The mixture was separated into 2 parts. One part was for rheometric measurement and another was for injection molding.

4.3.3 Mixing by the twin screw extruder

PC-2600 and CBC33 mixes were prepared by the counter rotating HAAKE twin screw extruder. The mixed concentration was 0.2 percent by weight of CBC33. The polycarbonate and the masterbatch were weighted to control percent of additive, dried and mixed before feeding into the hopper of the extruder. The temperature at three heating zone were maintained constant at 240°C, 250°C and 260°C with die temperature was 260°C (the lowest temperature that can used for mixing). Screw speed was 60 rpm and cooling water temperature was 33°C. The mixtures of PC-2405 and CBC33 were prepared like the mixture of PC-2600 and CBC33. Pure PC-2600 and pure PC-2405 were treated like the mixture to have the same thermal history. The mixture was separated into 2 parts. One part used for rheometric measurement and another used for injection molding.

4.3.4 Sample preparation for rheometric measurements

The pellets of the mixtures were placed into a perforated stainless mold with the diameter of 20 mm. and 1 mm. thickness. The mould was coated with releasing plates and heated for 5 minutes till the polymer was almost completely melted, then compressed by a hydraulic hot press at 290°C and 250 kg/cm³ for 5 minutes. After cooled by air for 3 minutes, the pieces of sample were removed from the mould and taken to measure shear viscosity, complex viscosity and modulus (G',G'') by the parallel plate rheometer.

Sample list

PC-2600 pure

PC-2405 pure

PC-2600 + CBC33, PC-2405 + CBC33	0.1%	by stirring melt mix
PC-2600 + CBC33, PC-2405 + CBC33	0.2%	by stirring melt mix
PC-2600 + CBC33, PC-2405 + CBC33	0.4%	by stirring melt mix
PC-2600 + CBC33, PC-2405 + CBC33	0.8%	by stirring melt mix
PC-2600 + CBC33, PC-2405 + CBC33	1.0%	by stirring melt mix
PC-2600 + GMS, PC-2405 + GMS	0.1%	by stirring melt mix
PC-2600 + GMS, PC-2405 + GMS	0.2%	by stirring melt mix
PC-2600 + GMS, PC-2405 + GMS	0.4%	by stirring melt mix
PC-2600 + GMS, PC-2405 + GMS	0.8%	by stirring melt mix
PC-2600 + GMS, PC-2405 + GMS	1.0%	by stirring melt mix
PC-2600 pure		by single screw extruder
PC-2405 pure		by single screw extruder
PC-2600 + CBC33	0.2%	mix by single screw extruder
PC-2405 + CBC33	0.2%	mix by single screw extruder
PC-2600 pure		by twin screw extruder
PC-2405 pure		by twin screw extruder
PC-2600 + CBC33	0.2%	mix by twin screw extruder
PC-2405 + CBC33	0.2%	mix by twin screw extruder

4.3.5 Injection molding from Single screw and Twin screw extruder

mixed

The pellets from single screw and twin screw extruders were used in a BOY injection molding machine model 22M. Before injection molding the pellets were dried for 10 hours at 120°C and then loaded into the hopper of the injection molding machine. The temperatures at four heating zones were maintained at 260°C, 265°C, 270°C and 275°C. Processing pressure was 160, 145 bar and holding pressure was 77 bar. Screw position was 38 mm and cooling time was 37 sec.

4.3.6 Sample preparation from injection molding for rheometric measurement

Cut the runner from injection molding into small pellets. Place the pellets into a perforated stainless mold with the diameter of 20 mm. and 1 mm. thickness. The mould was coated with releasing plates and heated for 5 minutes till the polymer was almost all melted, then compressed by a hydraulic hot press at 290⁰C and 250 kg/cm³ for 5 minutes. After cooled by air for 3 minutes, the pieces of sample were removed from the mould and taken to measure shear viscosity and complex viscosity by the parallel plate rheometer.

Sample list

PC-2600 pure from injection molding

PC-2405 pure from injection molding

PC-2600 pure from injection molding by single screw extruder

PC-2405 pure from injection molding by single screw extruder

PC-2600 + CBC33 0.2% from injection molding mix by single screw extruder

PC-2405 + CBC33 0.2% from injection molding mix by single screw extruder

PC-2600 pure from injection molding by twin screw extruder

PC-2405 pure from injection molding by twin screw extruder

PC-2600 + CBC33 0.2% from injection molding mix by twin screw extruder

PC-2405 + CBC33 0.2% from injection molding mix by twin screw extruder

4.4 Method of Determination

4.4.1 Shear viscosity

The procedure was carried out by using parallel plate sensor with 20 mm. plate diameter. Firstly, dry the air baring with nitrogen for 1 hour; switch on the air compressor, temperature controller, rheometer testing instrument and computer. Then,

start the control software and log in the step-change shear rate mode. The parameters were set as follows,

Maximum stress	:	100 kPa
Shear rate	:	0.1 to 10 sec ⁻¹
Temperature	:	230 ^o C

4.4.2 Complex viscosity

The procedures are carried out by using parallel plate sensor with 20 mm. plate diameter. Firstly, dry the air baring with nitrogen for 1 hour; switch on the air compressor, temperature controller, rheometer testing instrument and computer. Then, start the control software and log in the frequency sweep mode. The parameters were set as follows,

Frequency	:	10 ⁻² to 1 Hz.
Shear stress	:	10 ³ Pa
Temperature	:	230 ^o C

4.4.3 Melt Flow Index

Before melt flow index measurement, the pellets were dried for 10 hour at 120^oC. 8 g. of sample were loaded into the melt flow index capillary and the test was earned out at 300^oC using 2.16 kg. weight. Extrudates was cut at every 5 second. Weights of extrudates in grams per 10 minute are calculated and averaged from 5 samples. These values in gram/10 min., were recorded as melt flow indices of the samples.

Chapter 5

Results and Discussions

From the literature survey in Chapter 2, the polymer blends, which contained liquid crystal polymers (LCP) were improved in their processability with the viscosity reduction in melting state while the mechanical properties such as tensile strengths were improved like the composite materials. However, the amount of LCP in the blend has to be larger than 5% by weight.

In this research, the blends of low molar mass liquid crystals (CBC33) with Poly(bisphenol A carbonates) or shortly called Polycarbonate were chosen because they have high melt viscosity and wide range of applications. The rheological properties of these polymers and their blends with low molar mass liquid crystal were investigated.

Processing of polycarbonates is difficult because of their high melt viscosity. In general, the additive will be added during processing to decrease the melt viscosity. General polycarbonates have melting temperature around 230-300°C depending upon the molecular weight. In this research, low molar mass liquid crystal was selected as a polycarbonate additive for reducing viscosity of the blends because in the previous studies [Chuenchaokit, A., 1998, Powanusorn, S., 2000] showed that there is the tendency to use LC as a melt viscosity modifier as same as lubricant but without the reducing the thermal and mechanical properties. The effects of mixing and processing on the viscosity of Polycarbonate blends with low molar mass liquid crystal were also studied. The thermotropic liquid crystal, Cyclohexylbiphenyl cyclohexane (CBC33) was chosen in this study because it was assumed that thermotropic liquid crystals would decrease the melt viscosity of polymers due to their anisotropic nature and CBC33 has nematic temperature in the same range as processing temperatures of polycarbonates. [Powanusorn S., 2000]

5.1 The roles of melt viscosities in different experiments.

Melt viscosity is the flow behavior of polymer melts. For common liquids, the viscosities are constant and only dependent on temperature and pressure. For polymeric materials, rate of deformation and time have to be included as ones of the key factors. Melt viscosity data is a good practical importance in polymer processing because it relates the flow properties to the operating conditions. There are many ways to measure melt viscosity, using capillary rheometer can investigate melt viscosity at shear rate of most polymer processing that is in the range of $1-10^4 \text{ s}^{-1}$. In this experiment, shear viscosity and complex viscosity are the results that represent the melt viscosity at lower shear rate than capillary rheometer that is in the range of $0.1-10 \text{ s}^{-1}$ and $0.01-1 \text{ s}^{-1}$ respectively.

Shear viscosity is obtained as the ratio between shear stress and rate of shear, $\eta = \tau / \dot{\gamma}$. Complex viscosity is unsteady simple flow or small-amplitude oscillatory flow, defined as $\eta^* = \eta' - i\eta''$ according to theory in page 30-31. From shear sweep mode the rheometer applied shear rate in the range of $0.1-10 \text{ s}^{-1}$. Shear viscosities are obtained from shear sweep mode. In the case of frequency sweep mode, the rheometer applied frequency at 10^{-2} to 1 Hz at shear stress 10^3 Pa . Complex viscosities are measured from frequency sweep mode.

In this experiment viscosity is a function of either shear rate or frequency depending on the test method at constant temperature, 230°C where the PC is usually melted and ready to process. When applied either more shear rate or frequency, the viscosity is reduced according to the pseudoplastic characteristic which are common among polymers. The reduction of viscosity of the polymer implies that at higher shear rate or frequency, polymer melt can flow better than either lower shear rate or frequency.

Shear viscosity and complex viscosity had different shear rate range. From Cox and Mertz rule (from equation 3.36), it can directly relate shear viscosity with the absolute value of complex viscosity. The relationship simply indicates that complex viscosity is equal to steady-shear viscosity over a small range of shear rate or frequency. However the results from shear viscosity and complex viscosity in the experiments have shown that Cox and Mertz rule was impractical to be used with this system. This might be due to highly non-linear viscoelastic behavior of this polymer as a result of other additive added which can be seen from further discussion, and the deviation of viscosity from Power Law in the pseudo plastic range.

Power Law model is the simplest empiricism for viscosity in the pseudo plastic range. From raw data of pure PC-2600 and pure PC-2405, one can plot the Power Law model graph in changing variable form as:

$$\log \eta = \log m + (n - 1)\log \dot{\gamma} \quad (5.1)$$

If the solution is Newtonian the variation of viscosity with $\dot{\gamma}$ will be negligible and this equation reduces to $\log m$ only. From raw data of pure polycarbonate and equation 5.1, the slope, the intercept and trend line of Power Law model can be obtained. Shear viscosity of pure polycarbonates, polycarbonate blends with 0.1% additive and shear viscosity of polycarbonate from Power Law model are shown in **Figure5-1** to **Figure5-4**. Experimental data of pure polycarbonates has shear viscosity deviated from a linear behavior of polycarbonate predicted by the Power Law model. In the case of polycarbonate blends with 0.1% additive, the shear viscosity shows even larger deviation from shear viscosity of polycarbonates predicted by Power Law model than the pure polycarbonates. This effect is due to non-linear behavior of the blends reflecting viscosity characteristics. The results may be attributed to anisotropic state caused by CBC33 addition into the polycarbonate system. Shear viscosity versus shear rate of **Figure 5-1** to **Figure 5-4** are similar to the first graph among six graphs in Appendix C that show rheological behavior of anisotropic polymer.

CBC33 can effectively reduce viscosity of the polycarbonate; this might be a consequence of orientation in the liquid crystal's nematic phase. As a result, anisotropic properties over the range of processing temperature of polycarbonates can be generated. At the anisotropic state, the polymer molecules tend to be aligned into flow direction, resulting in better flow and lower viscosity of the system. Chain alignment and orientations of the liquid crystal depend largely on flow fields, mixing efficiency (dispersive and/or distributive mixing) and other process parameters. When the melt viscosities are plotted as a function of shear rate or frequency, log-log curves cannot represent the differences in the viscosity. So the values in the normal scale were showed instead of the tradition log-log curve. The deviation of the properties from the normal pseudoplastics (that represented by power law) showed the strange mechanism of the melt viscosity modifications by using low molar mass liquid crystal and even if applying the lubricant.



สถาบันวิทยบริการ
จุฬาลงกรณ์มหาวิทยาลัย

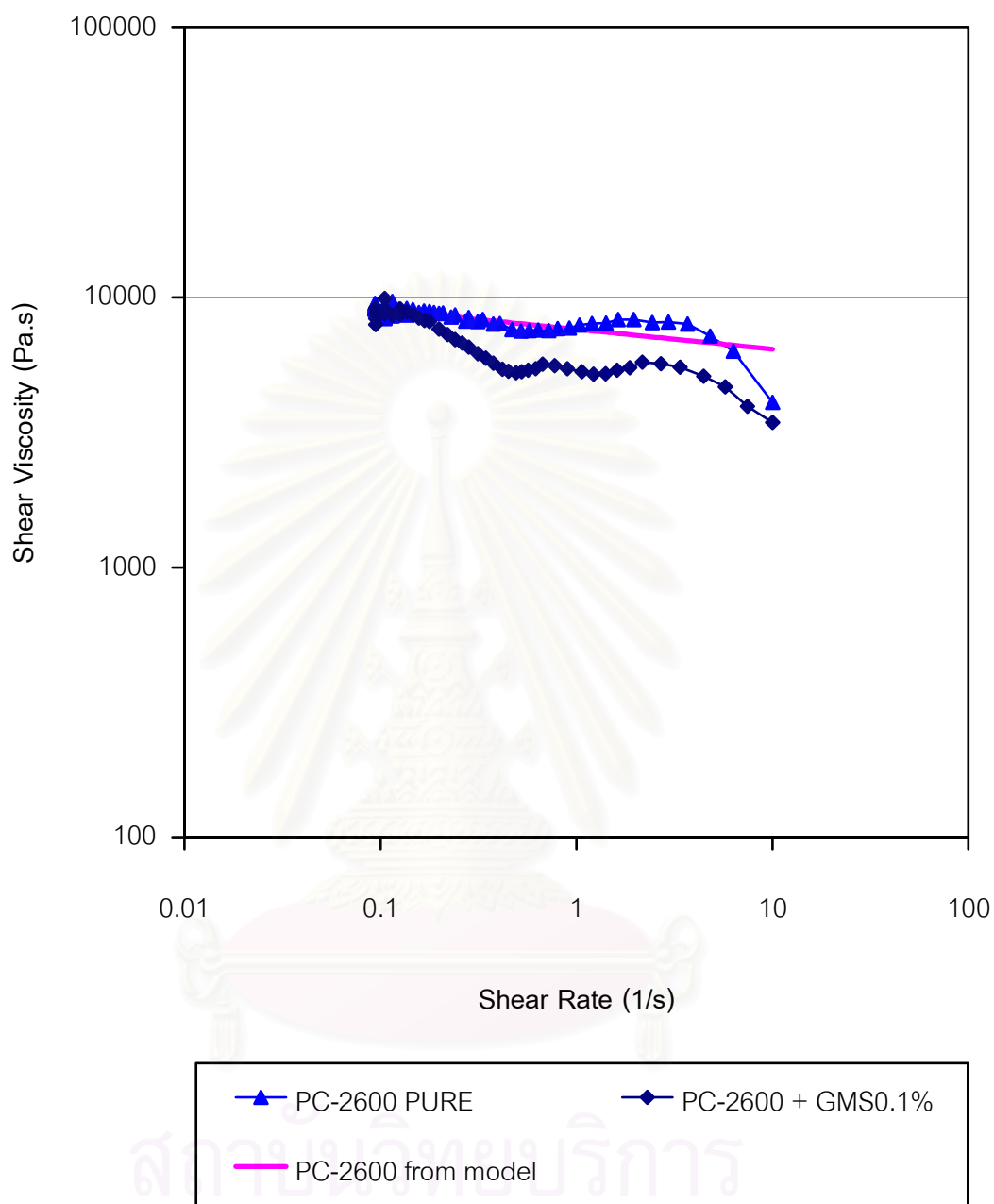

Figure 5-1 Shear Viscosity of PC-2600 pure, PC-2600 blends with GMS 0.1%wt and Shear Viscosity of PC-2600 from Power law model versus shear rate

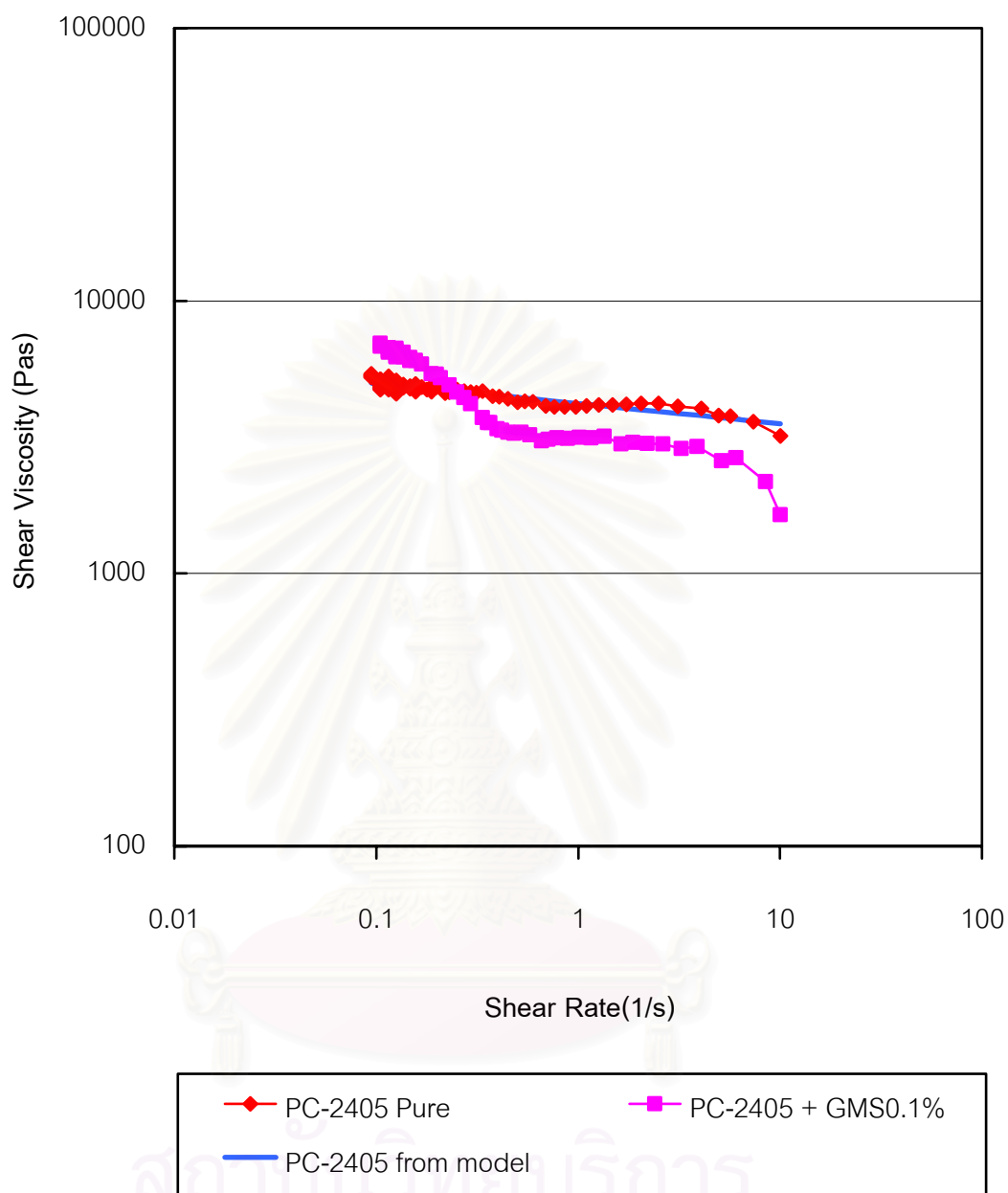

Figure 5-2 Shear Viscosity of PC-2405 pure, PC-2405 blends with GMS 0.1%wt and Shear Viscosity of PC-2405 from Power Law model versus shear rate

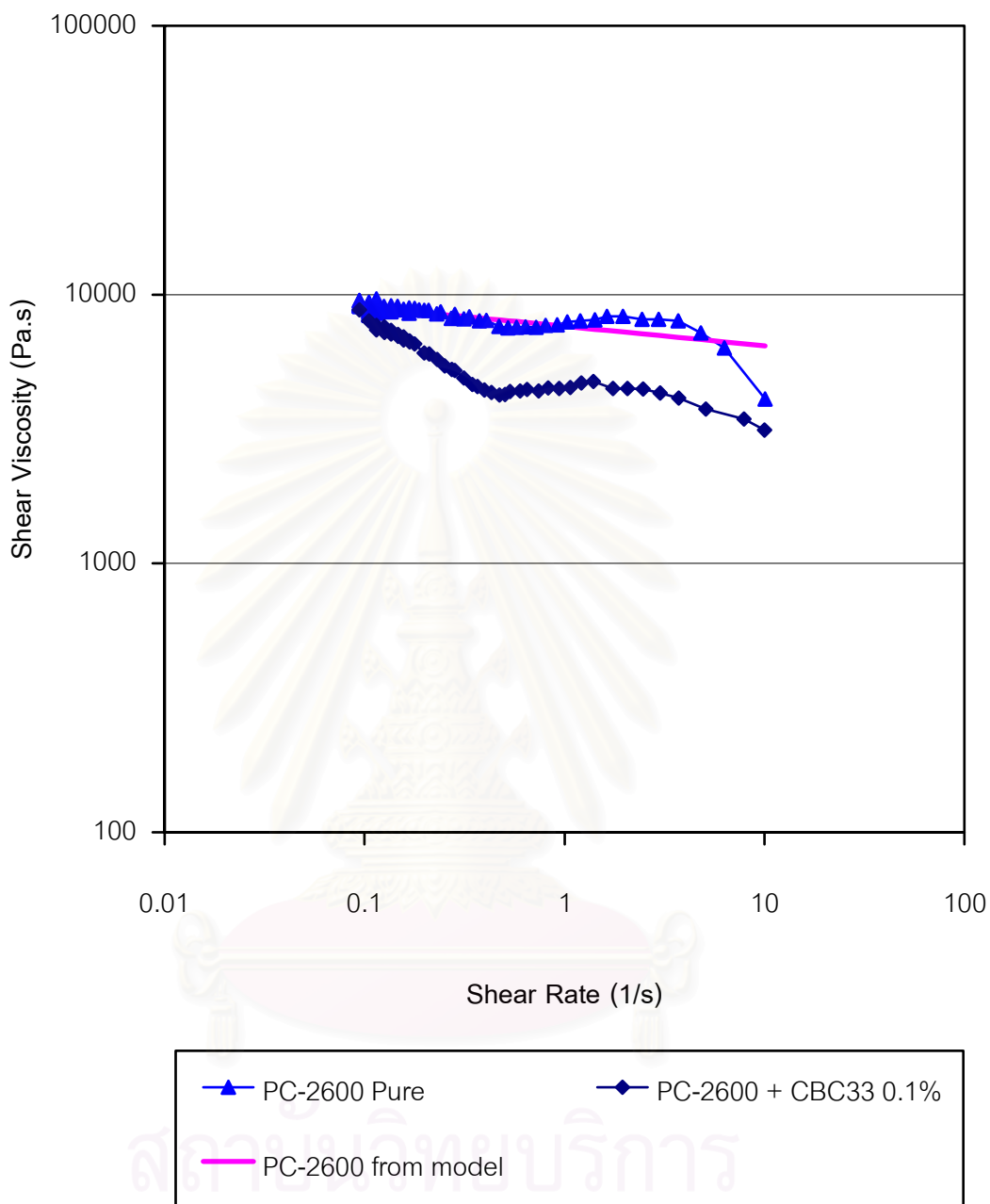

Figure 5-3 Shear Viscosity of PC-2600 pure, PC-2600 blends with CBC33 0.1%wt and Shear Viscosity of PC-2600 from Power Law model versus shear rate

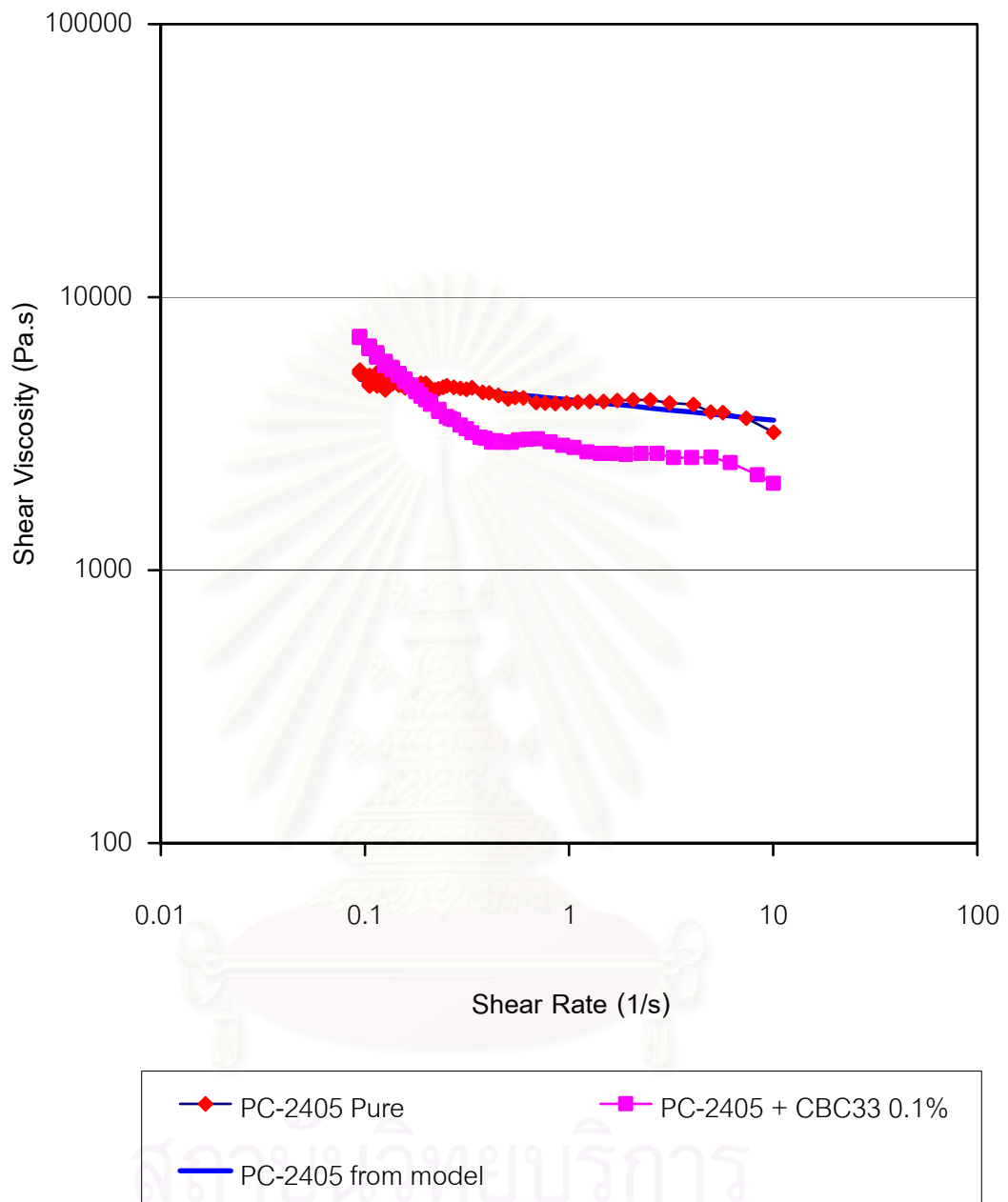

Figure 5-4 Shear Viscosity of PC-2405 pure, PC-2405 blends with CBC33 0.1%wt and Shear Viscosity of PC-2405 from Power Law model versus shear rate

5.2 The reduction in melt viscosities according to lubricant (GMS).

The shear viscosity versus shear rate results of polycarbonate blends at 0.1, 0.2, 0.4, 0.8, and 1% composition GMS by stirring melt mix at 230°C are shown in **Figure 5-2** and **Figure 5-3**. Complex viscosity versus frequency results of these blends at above percent composition of GMS by stirring melt mix at 230°C are shown in **Figure 5-4** to **Figure 5-5**. The influences of GMS on viscosities of polycarbonate blend comparing with pure polycarbonates show that the viscosity drops when adding GMS into polycarbonates because it is the internal lubricant.

When adding 1% by weight of GMS in PC-2600, the shear viscosity of PC-2600 decreases about 45% and the complex viscosity decreases about 30%. When adding 1% by weight of GMS in PC-2405, the shear viscosity of PC-2405 decreases about 42% and the complex viscosity decreases about 30%. If the viscosity of the PC-2600 were considered, the more lubricant added, the more reduction in the melt viscosity and it has the same results in the shear viscosity and complex viscosity. However, the recommended values of GMS was at 0.1%, because the reduction in the viscosity cannot be beyond 0.1%. The differences were limited in the low range of the composition of the GMS. The results with PC-2405 were in the same trend as can be seen.

Viscosity reduction in polycarbonates containing GMS can be explained by GMS characteristics based on earlier studies. GMS could enhance the molecular mobility of SAN and PMMA melt mixed blends, plasticized and improved the blends melt flow properties [To be publish, S. Wacharawichanant, 2002]. Differential scanning calorimeter (DSC) results indicated that GMS had impact on decreasing glass transition temperature (T_g) of the blends. This could, however, lead to limitation at high temperature usage [Private communication, S. Wacharawichanant, 2002].

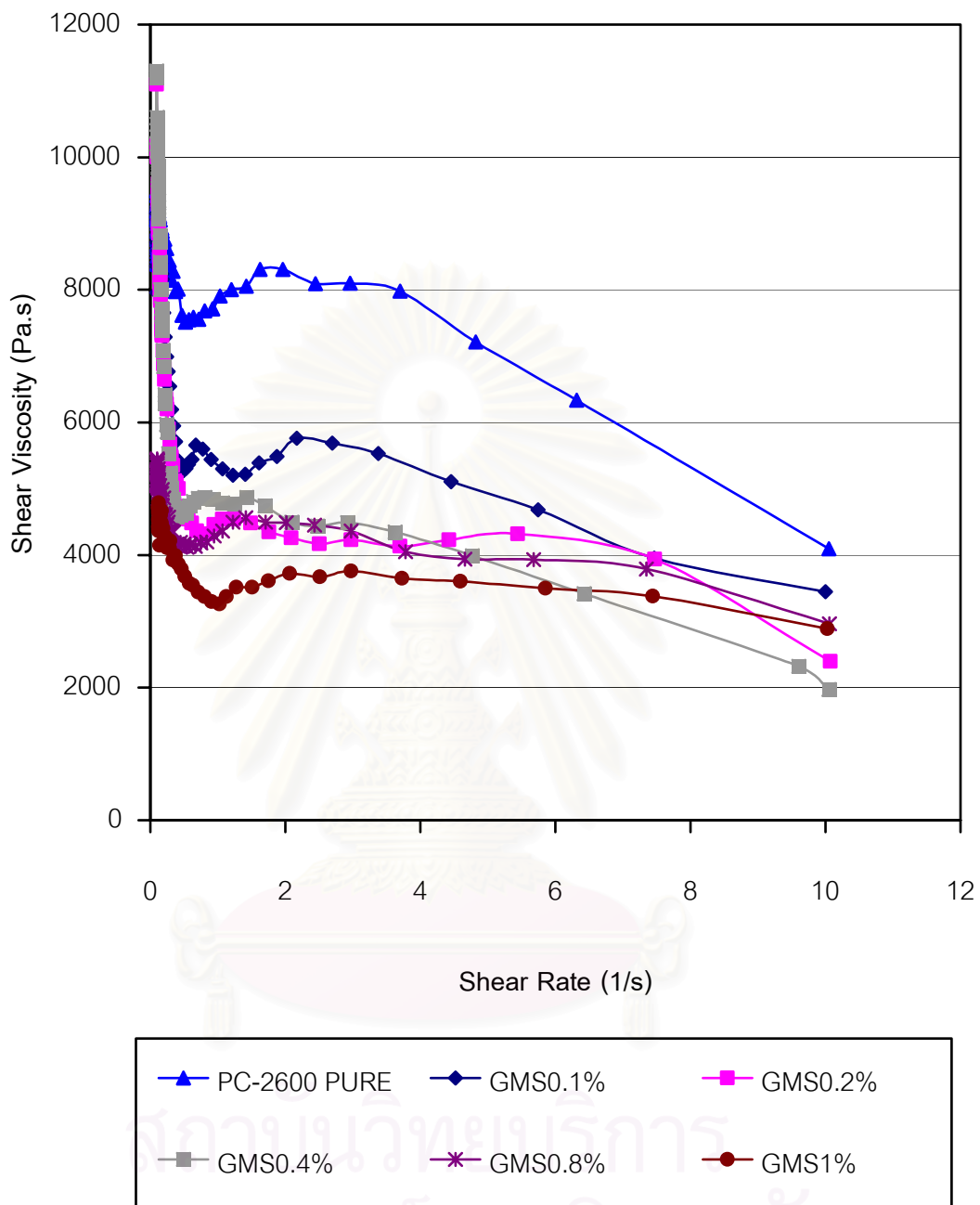

Figure 5-5 Shear Viscosity of PC-2600 versus shear rate at various compositions of GMS

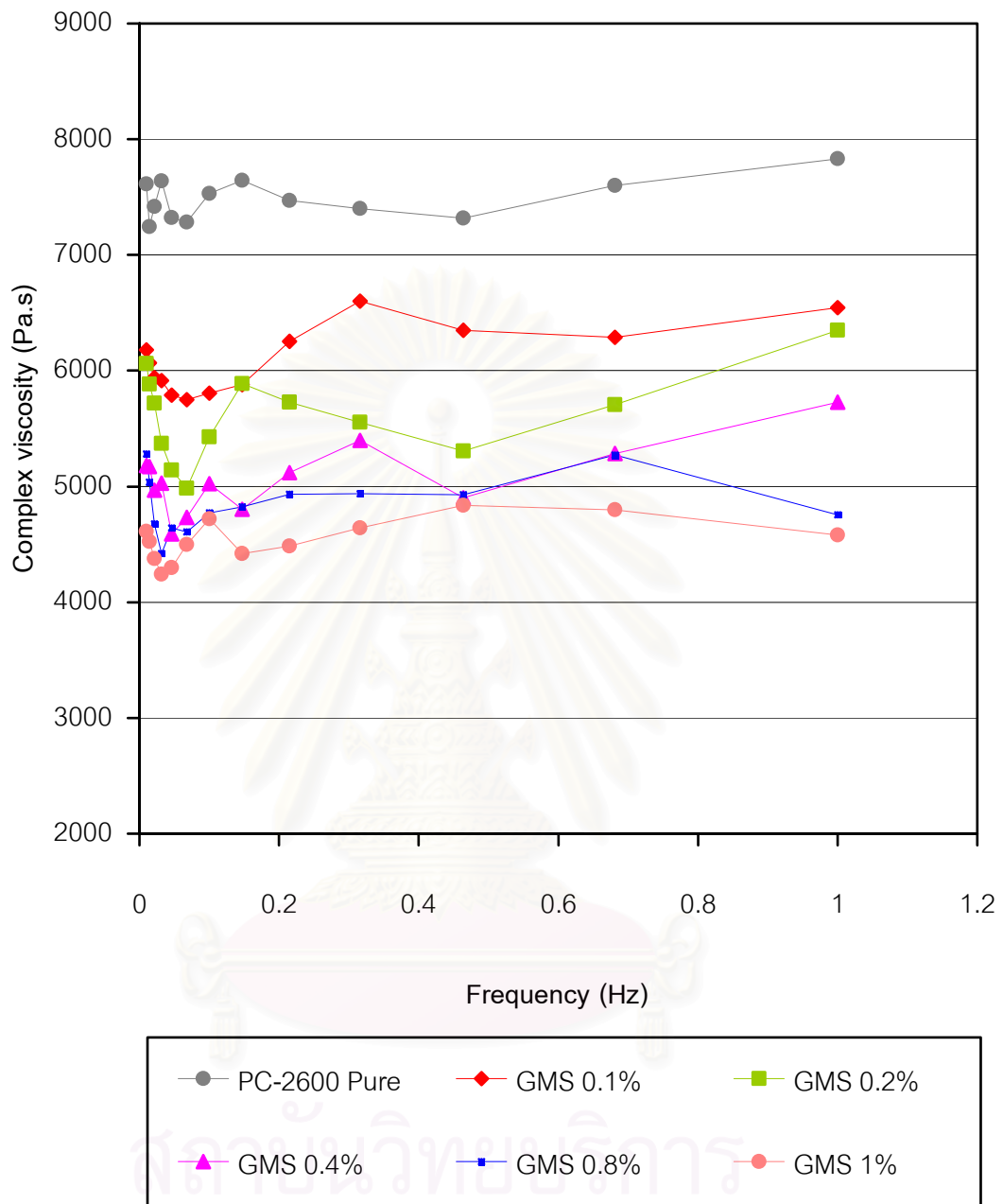

Figure 5-6 Complex Viscosity of PC-2600 versus frequency at various compositions of GMS

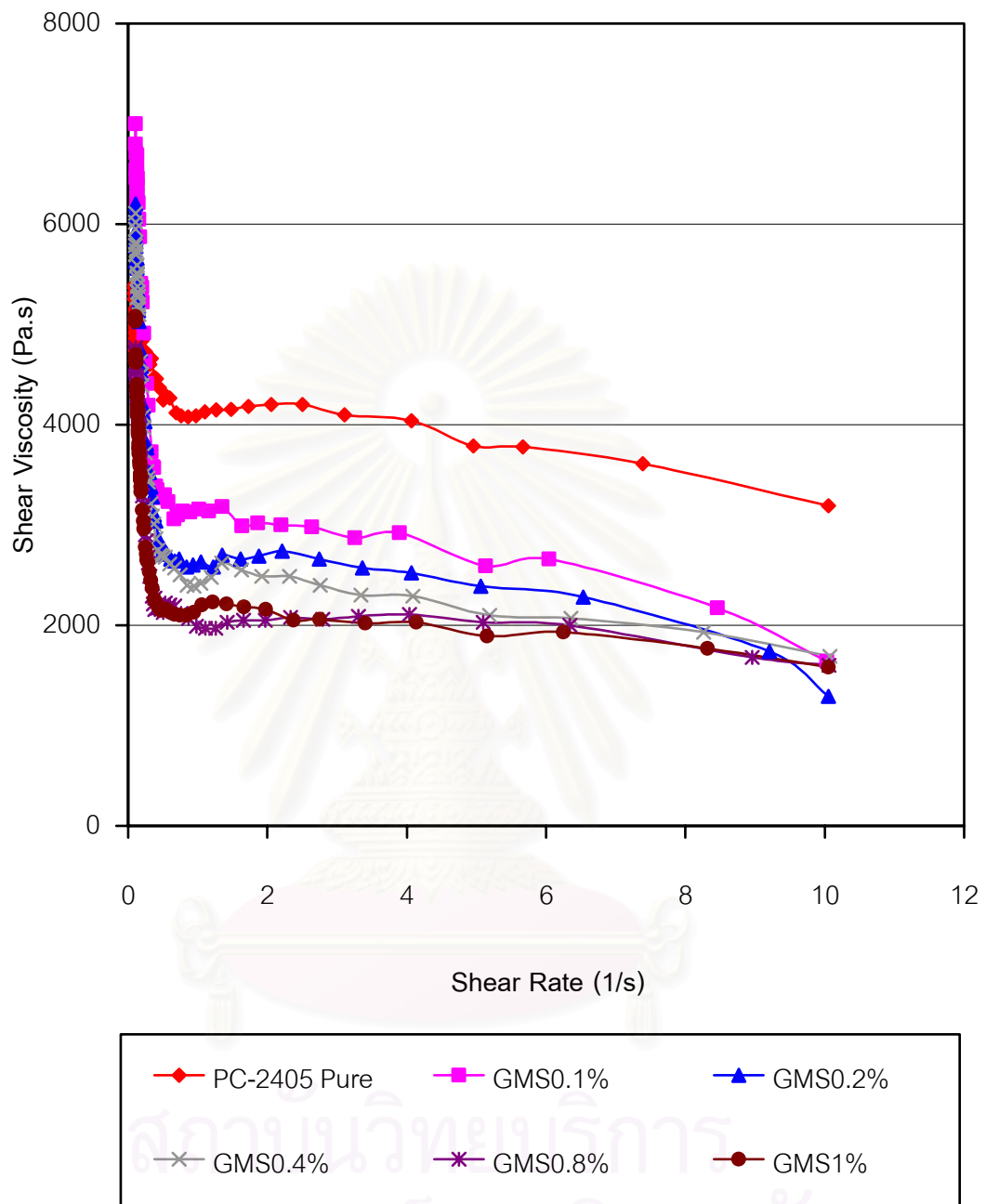

Figure 5-7 Shear Viscosity of PC-2405 versus shear rate at various compositions of GMS

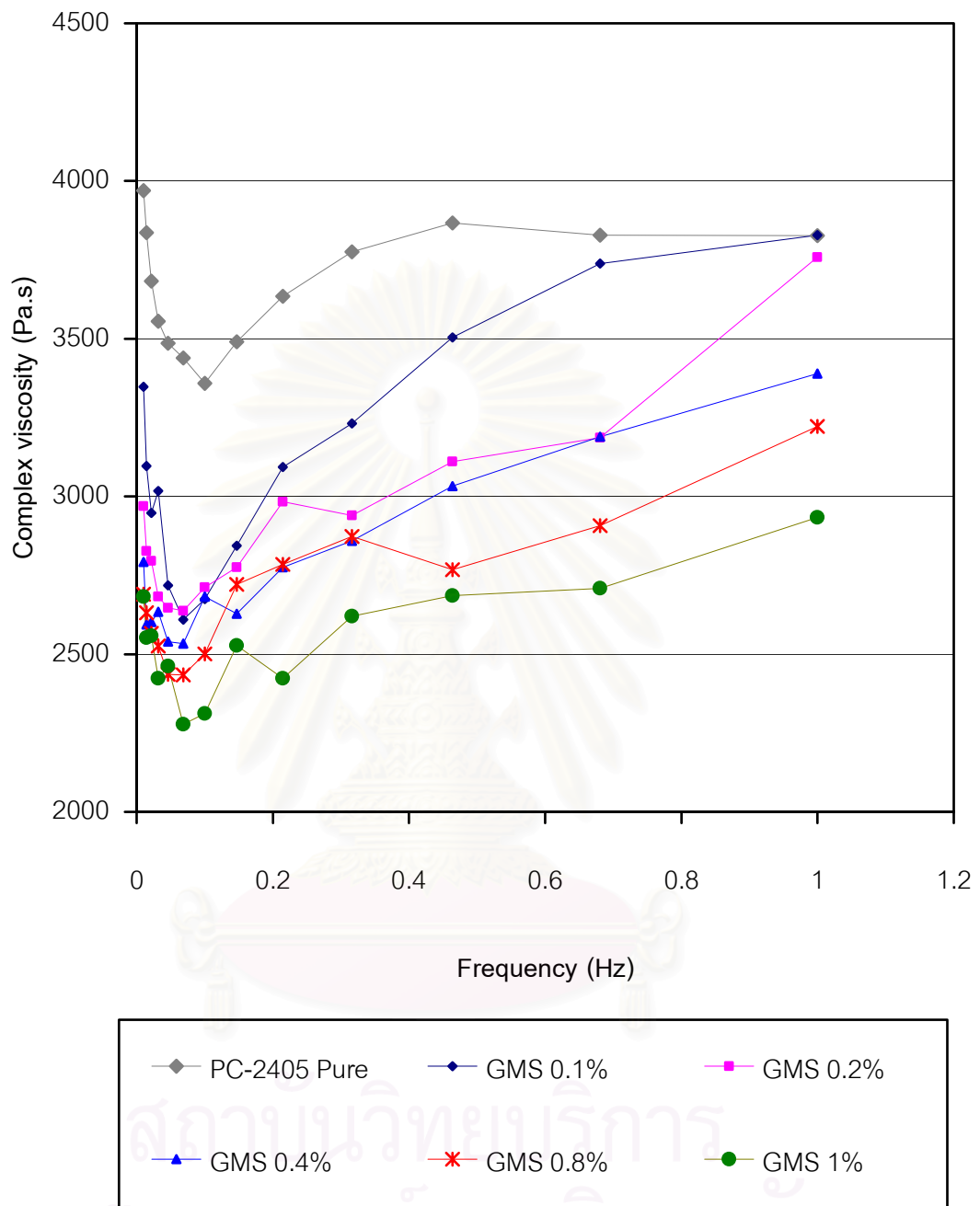

Figure 5-8 Complex Viscosity of PC-2405 versus frequency at various compositions of GMS

5.3 The trends of melt viscosities reduction according to LCC (CBC33).

Shear viscosity versus shear rate of polycarbonate blends at 0.1, 0.2, 0.4, 0.8, 1% composition of CBC33 by stirring melt mix on hot plate at 230°C are shown in **Figure 5-6** and **Figure 5-7**. Complex viscosity versus frequency of these blends at above percent composition of CBC33 are shown in **Figure 5-8** and **Figure 5-9**. The influence of CBC33 on the viscosity of polycarbonate blends comparing with pure polycarbonate shows that the viscosity drops when adding CBC33 into polycarbonates.

If the viscosity of the PC-2600 were considered, the more concentration of CBC33 added in PC-2600 matrix, the less viscosity of blend results. It is found that 0.2% by weight of CBC33 is the suitable concentration because at higher concentration of CBC33 (0.4% up), the effects of CBC33 in reducing viscosities of PC-2600 blends are less pronounced compared with lower concentration. The results with PC-2405 were in the same trend as can be seen.

At 0.2% of CBC33 shear viscosities of PC-2600 and PC-2405 decrease about 50% and 53%. Complex viscosity values of PC-2600 and PC-2405 decrease about 40% and 34%. In addition, the price of CBC33 and the effects obtained when mixing with CBC33 have to be balanced.

This experiment cannot investigate viscosity at high shear rate. Shear viscosity results represent the melt viscosity within a shear rate range of 0.1-10 s⁻¹, and complex viscosity results represent the melt viscosity within a range of about 0.06-6 s⁻¹. The results show that CBC33 can reduce the viscosity of polymer blend at low shear rate range. These results might infer to same effects at higher shear rate that has examined by using Capillary Rheometer and the similar results obtained [Chuenchaokit A., 1998].

Comparing with GMS at the same percent composition, the viscosity of polycarbonate blends with CBC33 show a larger decrease than that of GMS because CBC33 can better improve the molecular mobility of polymer blend [To be publish, S. Wacharawichanant, 2002]. The decreasing of Glass transition temperature of polycarbonate blends with CBC33 cannot be observed from the experimental [Private communication, S. Wacharawichanant, 2002], whereas GMS addition into the polycarbonate clearly reduces glass transition temperature. This can lead to limitation at high temperature usage.



สถาบันวิทยบริการ
จุฬาลงกรณ์มหาวิทยาลัย

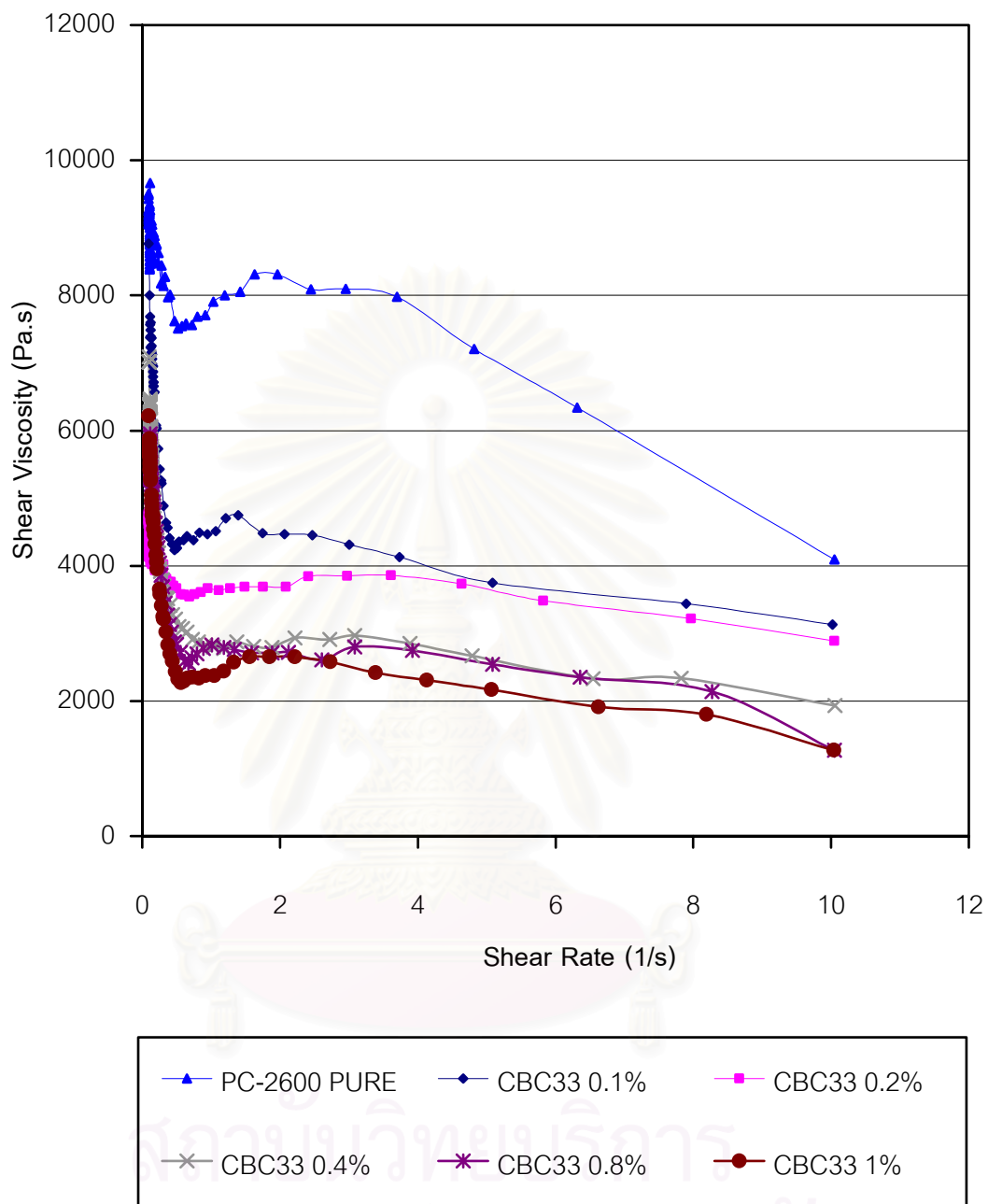

Figure 5-9 Shear Viscosity of PC-2600 versus shear rate at various compositions of CBC33

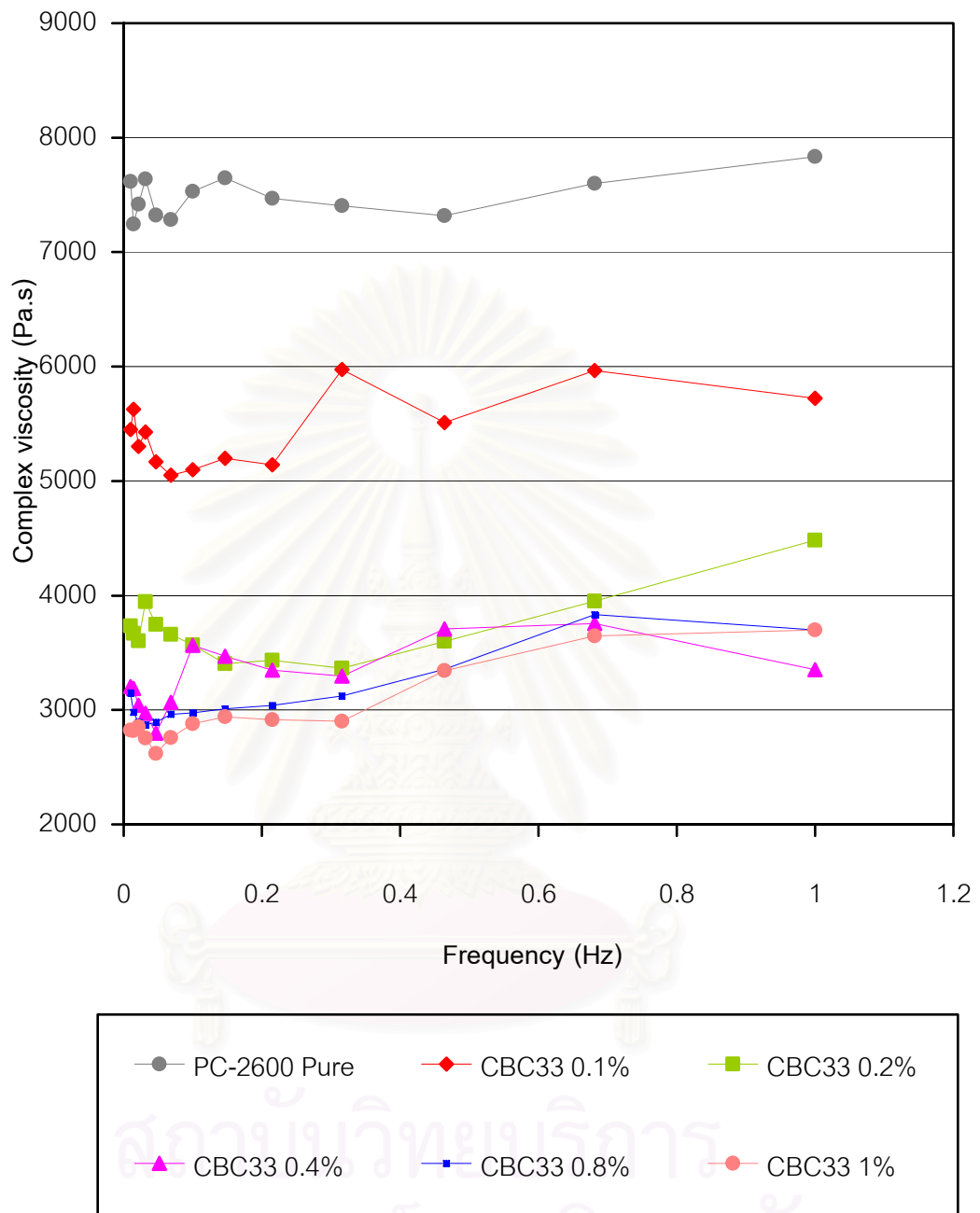

Figure 5-10 Complex Viscosity of PC-2600 versus frequency at various compositions of CBC33

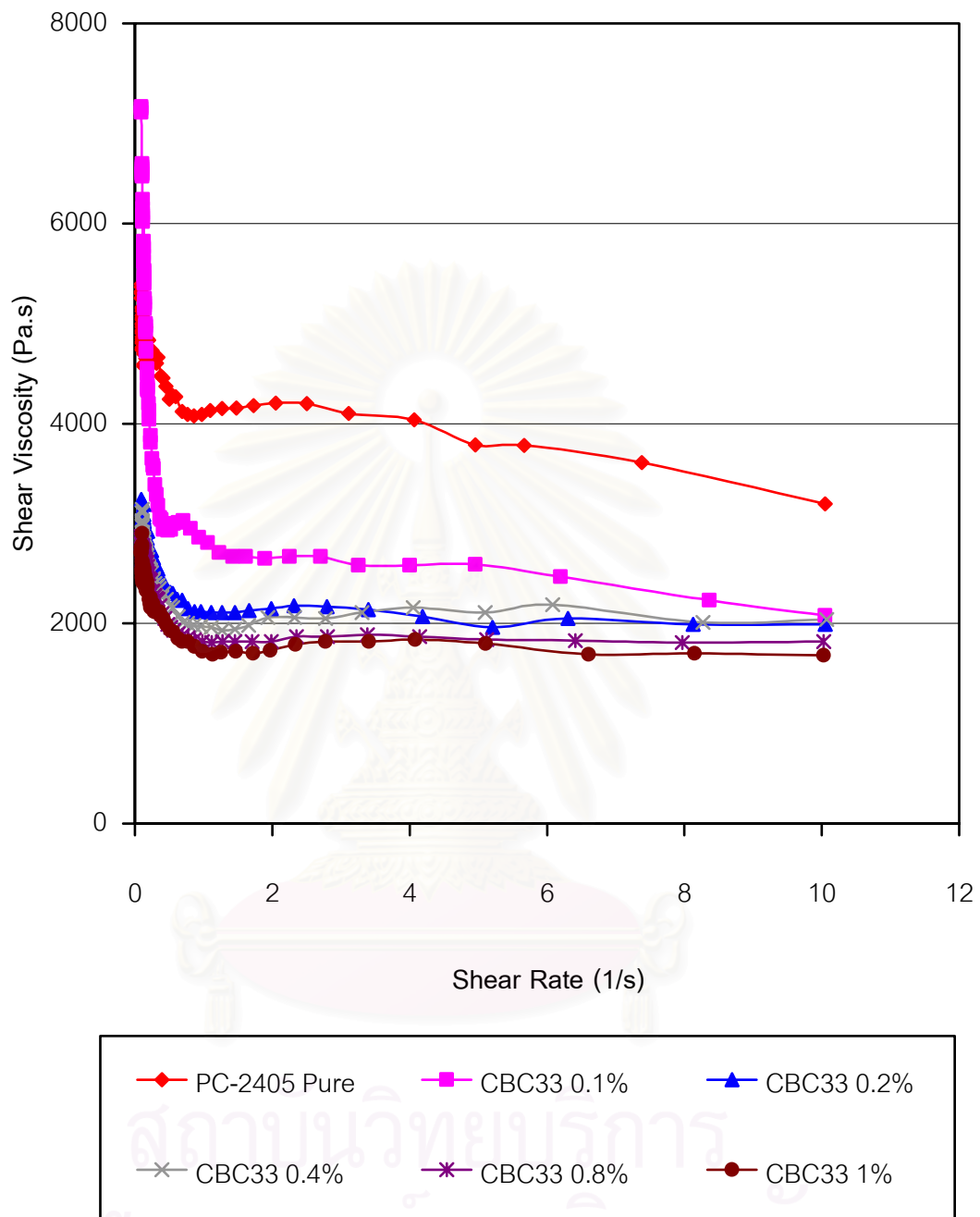

Figure 5-11 Shear Viscosity of PC-2405 versus shear rate at various compositions of CBC33

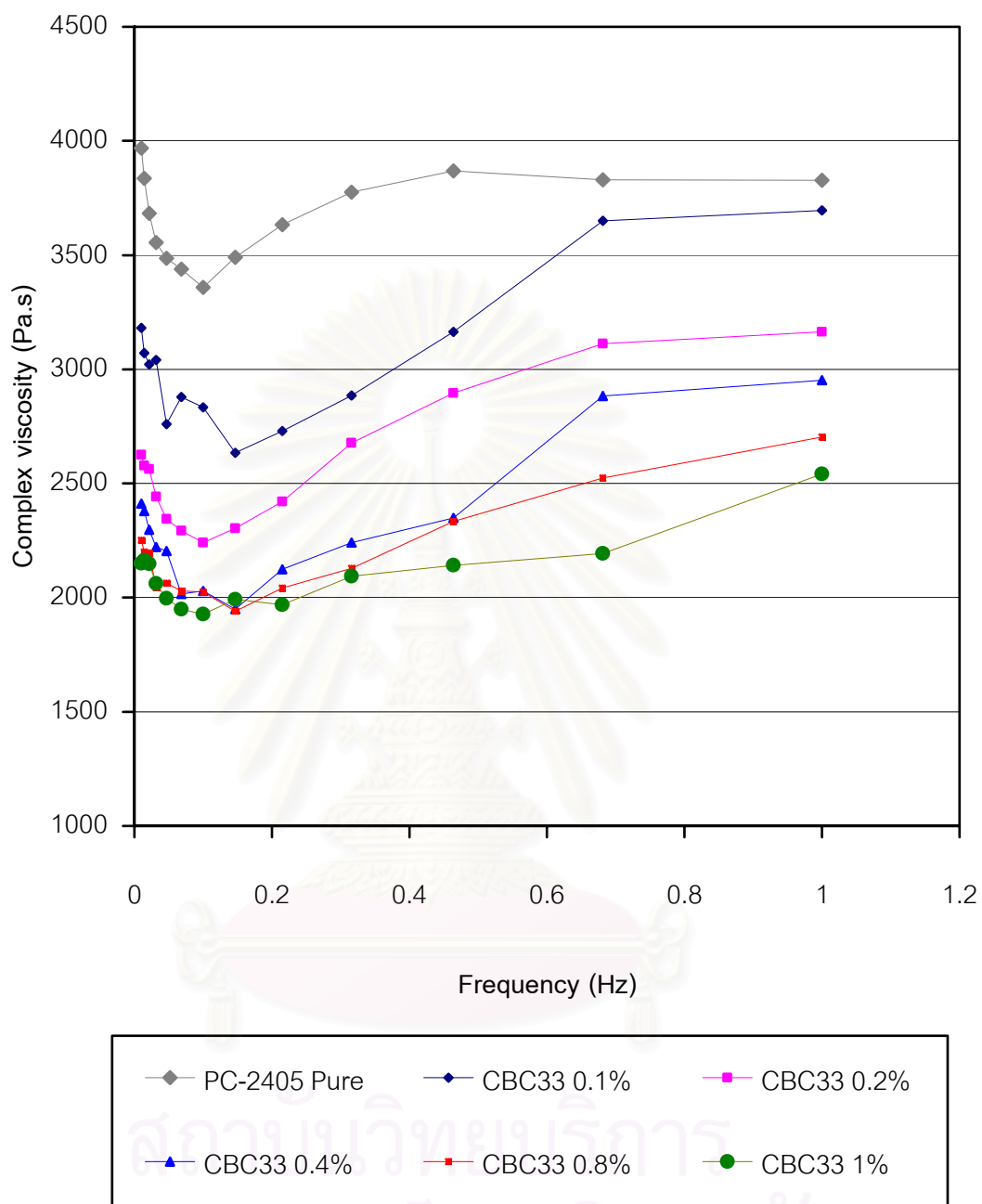

Figure 5-12 Complex Viscosity of PC-2405 versus frequency at various compositions of CBC33

5.4 Samples from different mixing methods and results of melt viscosities.

Figure 5-13 to Figure 5-16 show the shear viscosity and complex viscosity value of PC-2600, PC-2405 and their blends with 0.2% wt CBC33 using single screw extruder. In the case of PC-2600, shear viscosity and complex viscosity values of these blends are lower than stirred melt mix. Shear viscosity values of PC-2600 blends by single screw extruder is decreased about 59%. Complex viscosity value of this blend is decreased about 60%. In the case of PC-2405, shear viscosity and complex viscosity value of the blends are also lower than stirred melt mix. Shear viscosity value of PC-2405 blends by single screw extruder is decreased about 60%. Complex viscosity value of this blend is decreased about 65%.

All viscosities value from PC-2600 and PC-2405 blends by single screw extruder may be the better mixing, better distribution and better dispersion of CBC33 in polycarbonate due to bulk when mixing by single screw extruder as compared to stirred melt mix method. This indicates that the mixing methods have the pronounced effects on the properties (melt viscosity) of the mixed PC with CBC33.

Comparing PC-2600 blends versus PC-2405 blends prepared by single screw extruder, viscosity values of PC-2405 blends are closer to viscosities of stirred melt mix than the PC-2600 blend samples. The results may be because PC-2600 has lower viscosity than PC-2405, then CBC33 can be better mixed and are well distributed and dispersed in PC-2405 even in the case of the blends prepared by stirred melt mix.

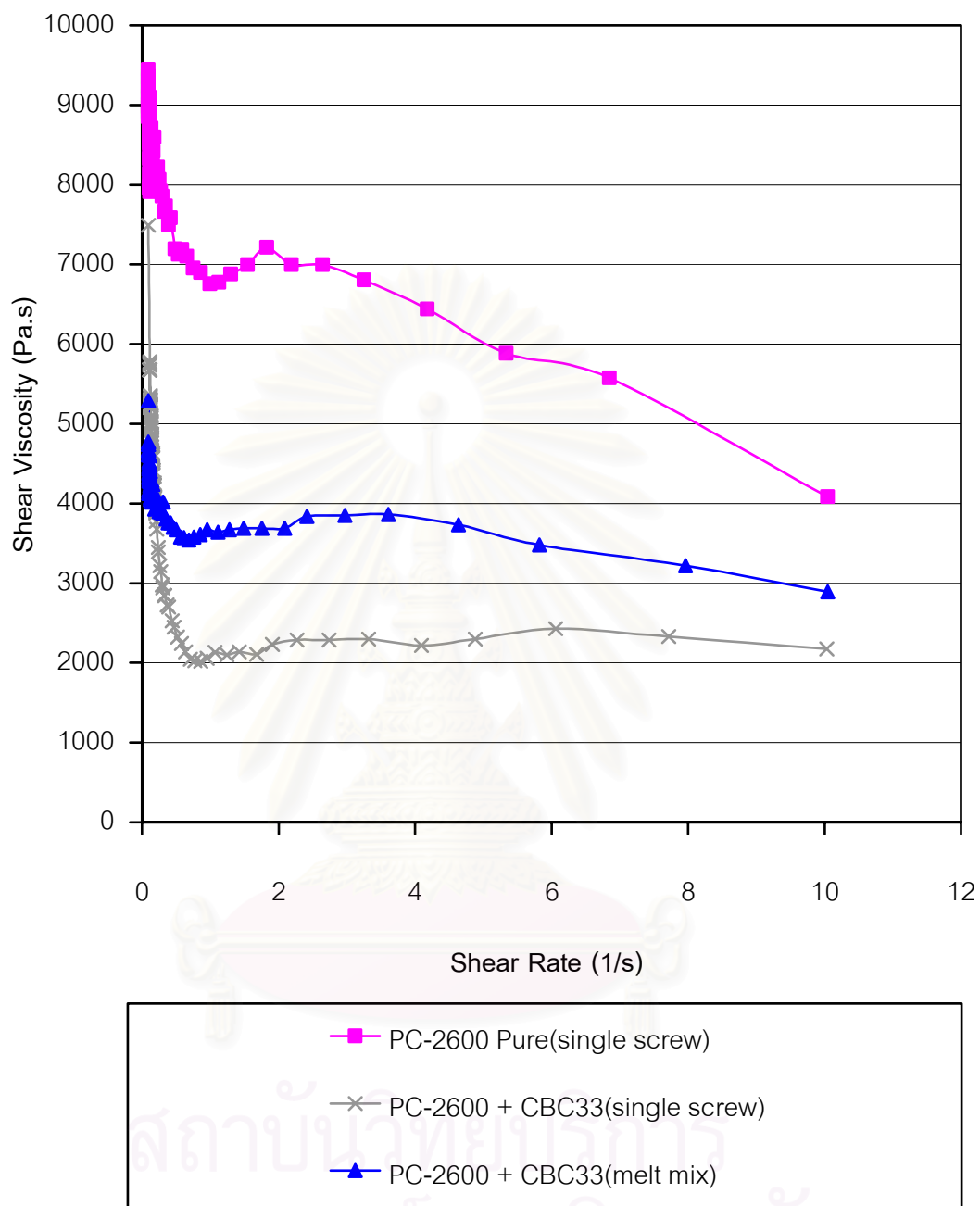

Figure 5-13 Shear Viscosity of PC-2600 blends with CBC33 by single screw extruder versus shear rate

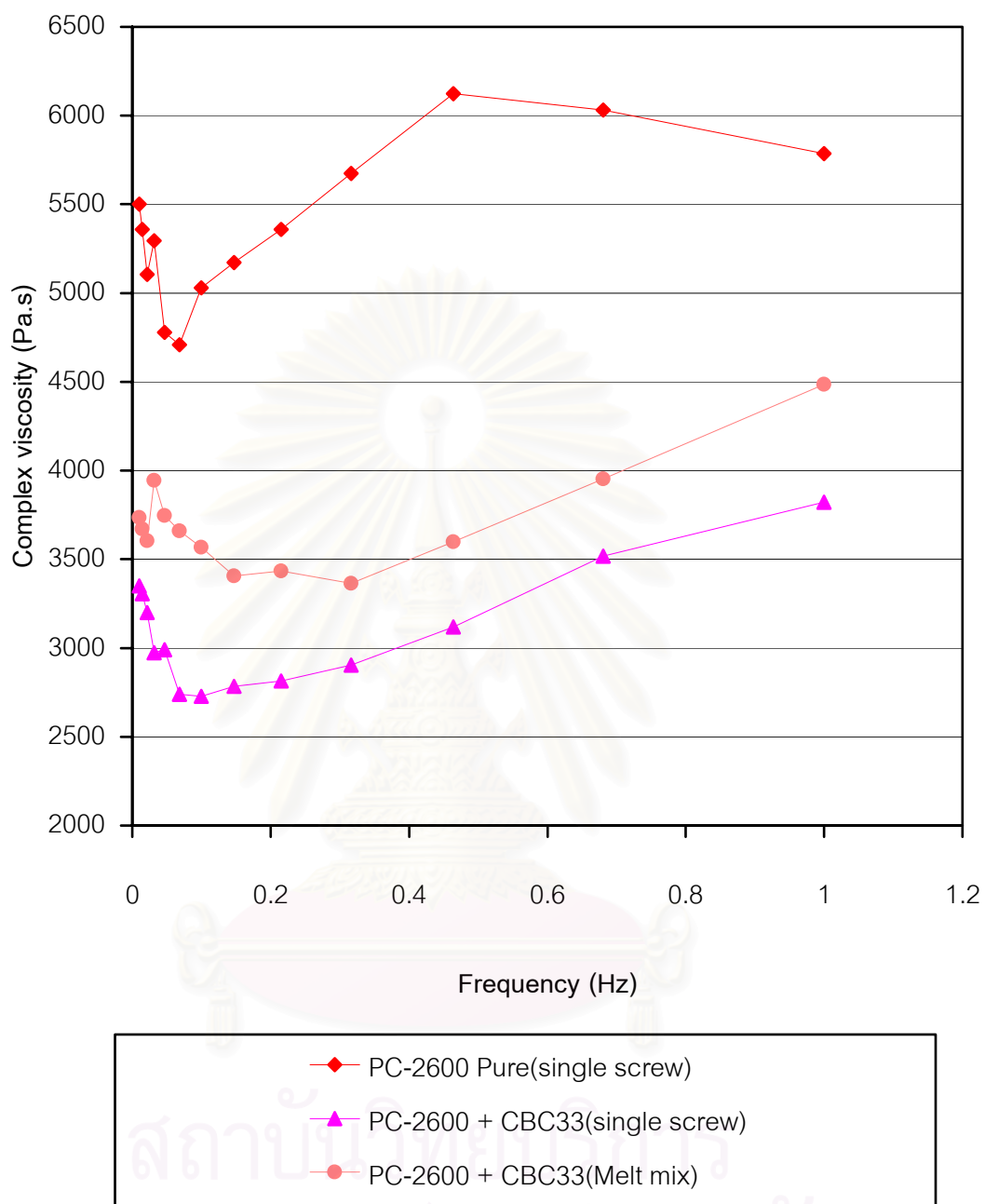

Figure 5-14 Complex Viscosity of PC-2600 blends with CBC33 by single screw extruder versus frequency

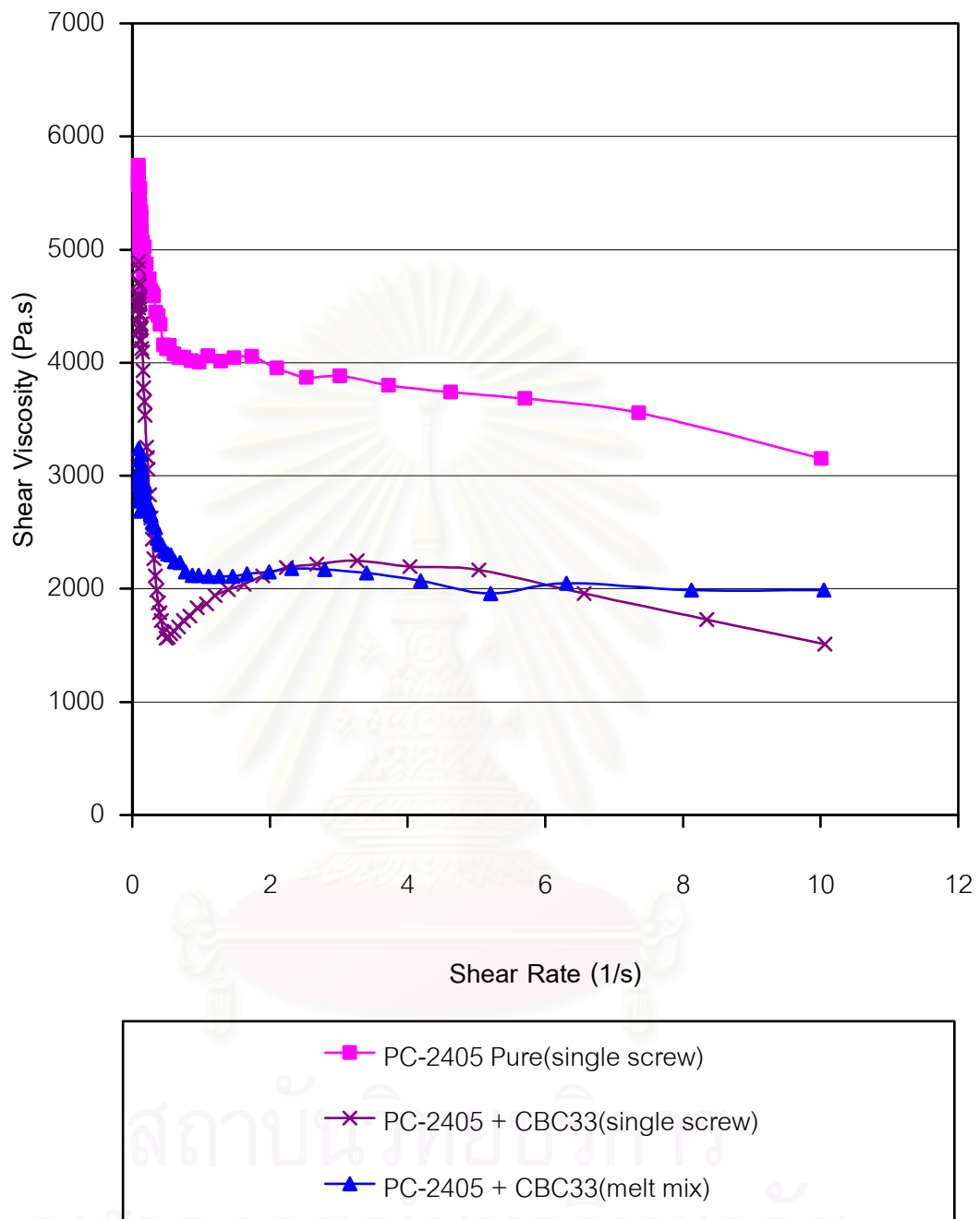

Figure 5-15 Shear Viscosity of PC-2405 blends with CBC33 by single screw extruder versus shear rate

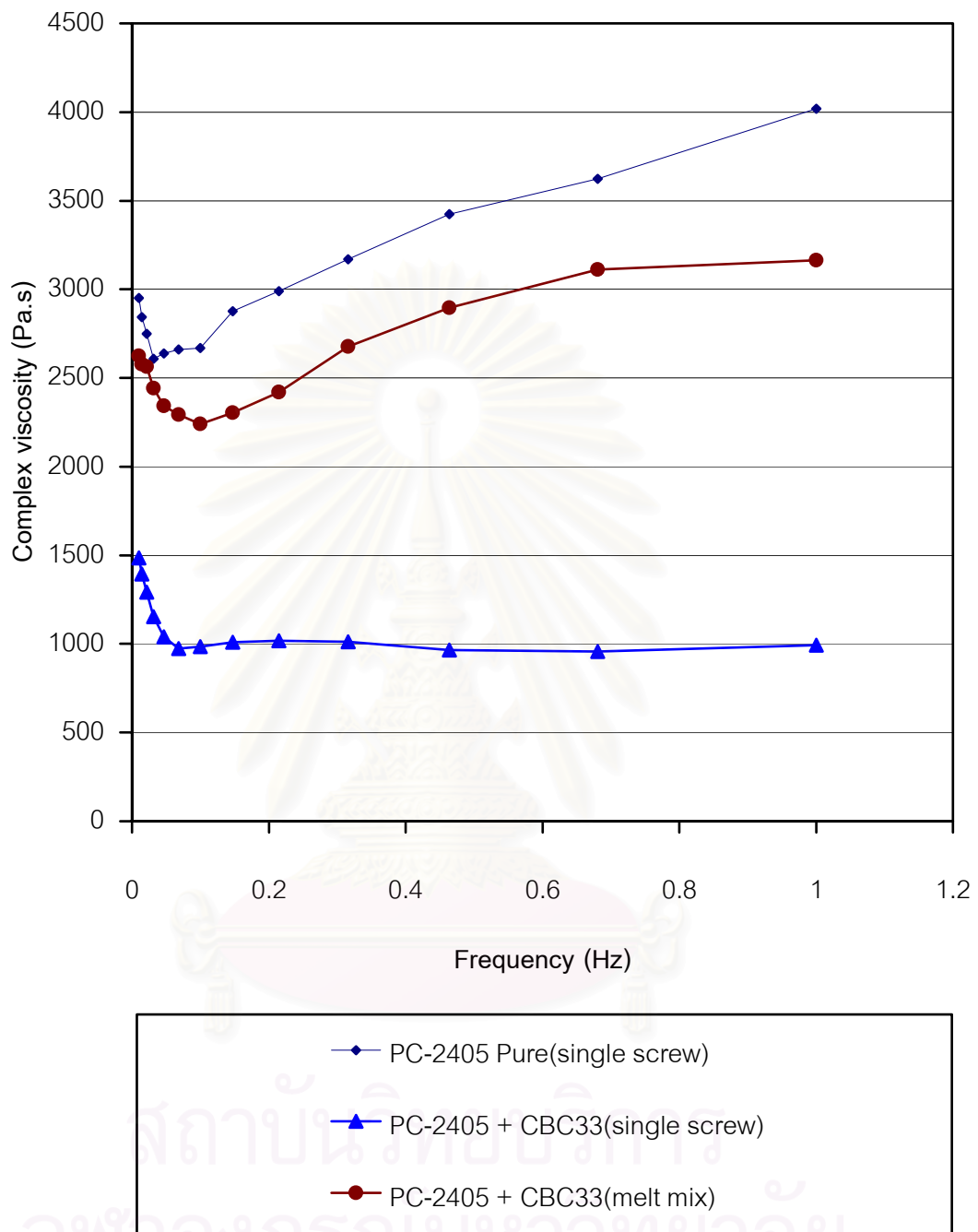

Figure 5-16 Complex Viscosity of PC-2405 blends with CBC33 by single screw extruder versus frequency

Figure 5-17 to Figure 5-20 show the shear viscosity and complex viscosity values of PC-2600, PC-2405 and their blends with 0.2% wt CBC33 using twin screw extruder. In the case of PC-2600, the viscosity values of the blends are slightly lower than stirred melt mix. Shear viscosity values of PC-2600 blends prepared by twin screw extruder is decreased from pure PC-2600 about 52% and complex viscosity of this blend is decreased about 43%. The results may be because the particular twin screw extruder used in this study has low mixing efficiencies or an effective amount of CBC33 included in the mixture is less than 0.2%.

In the case of PC-2405, the viscosity value of the blends give contradicts results. Shear viscosity values of PC-2405 blends prepared by twin screw extruder are higher than that for stirred melt mix, but complex viscosity values of this blend are lower than stirred melt mix. Shear viscosity values of PC-2405 blends by twin screw extruder decrease from pure PC-2405 about 32% and complex viscosity value of this blend decrease about 54%. The results may be an error from sample preparation in stirred melt mix. Samples used in shear viscosity test may have CBC33 more than 0.2% and sample used in complex viscosity test may have CBC33 less than 0.2%.

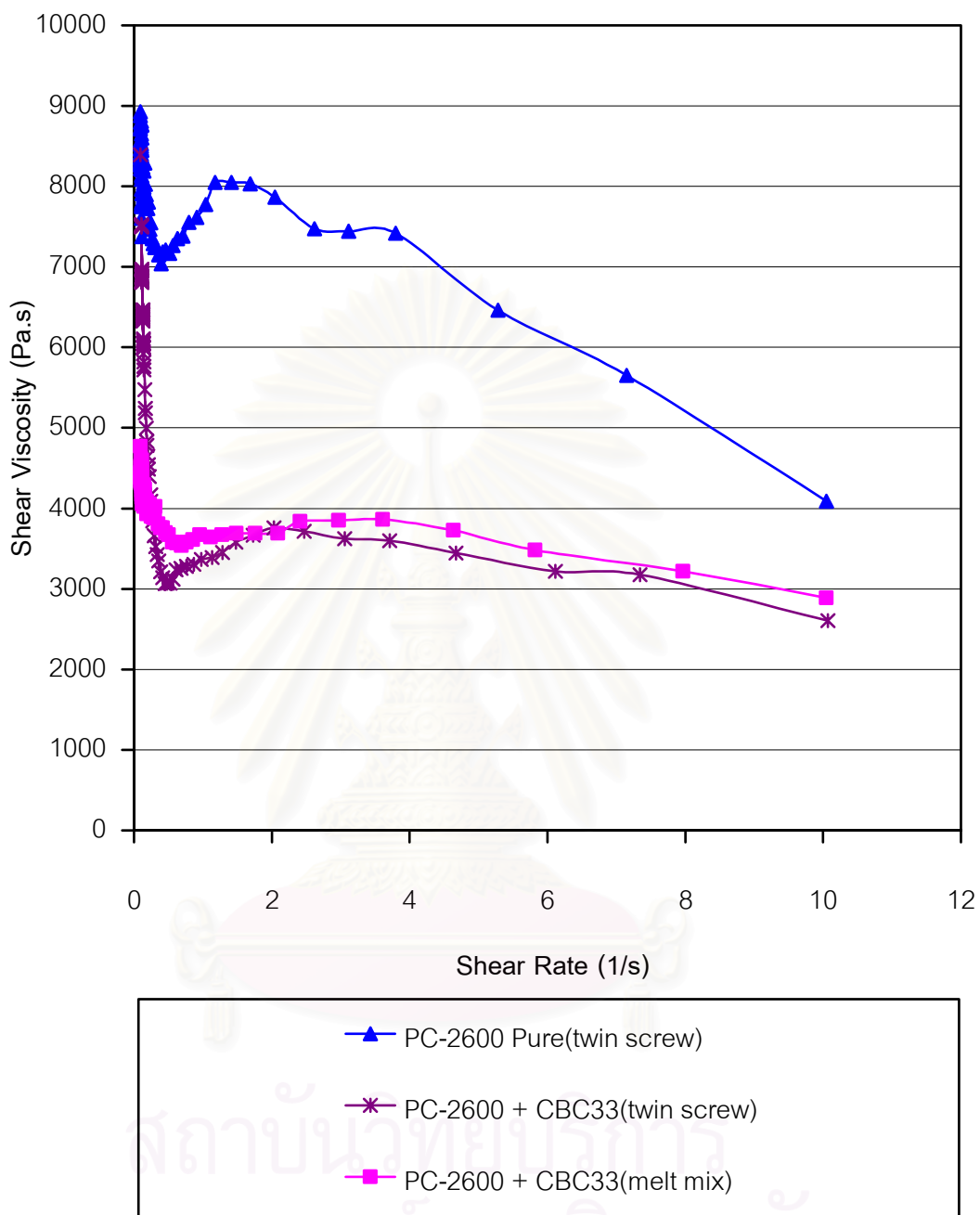

Figure 5-17 Shear Viscosity of PC-2600 blends with CBC33 by twin screw extruder versus shear rate

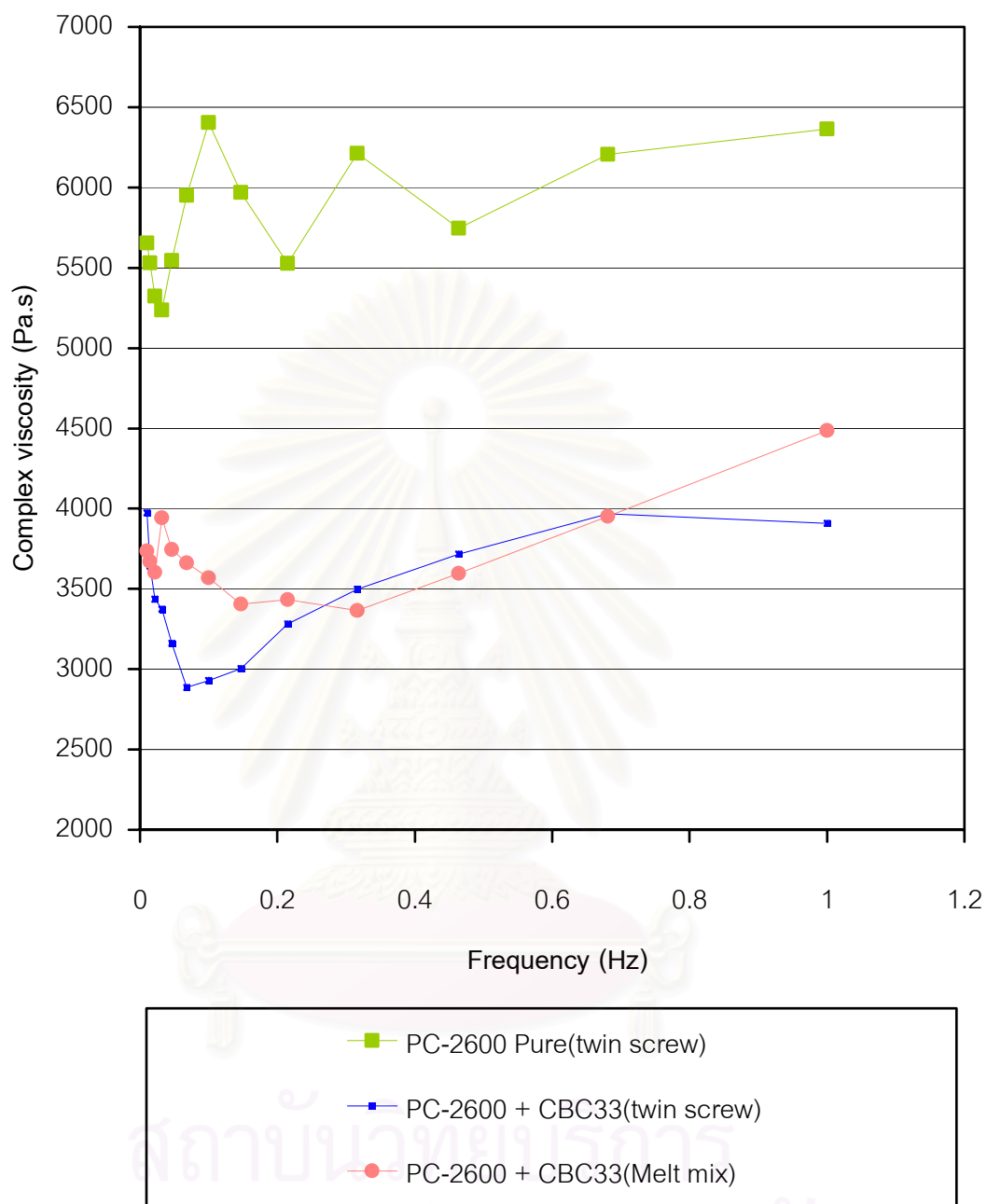

Figure 5-18 Complex Viscosity of PC-2600 blends with CBC33 by twin screw extruder versus frequency

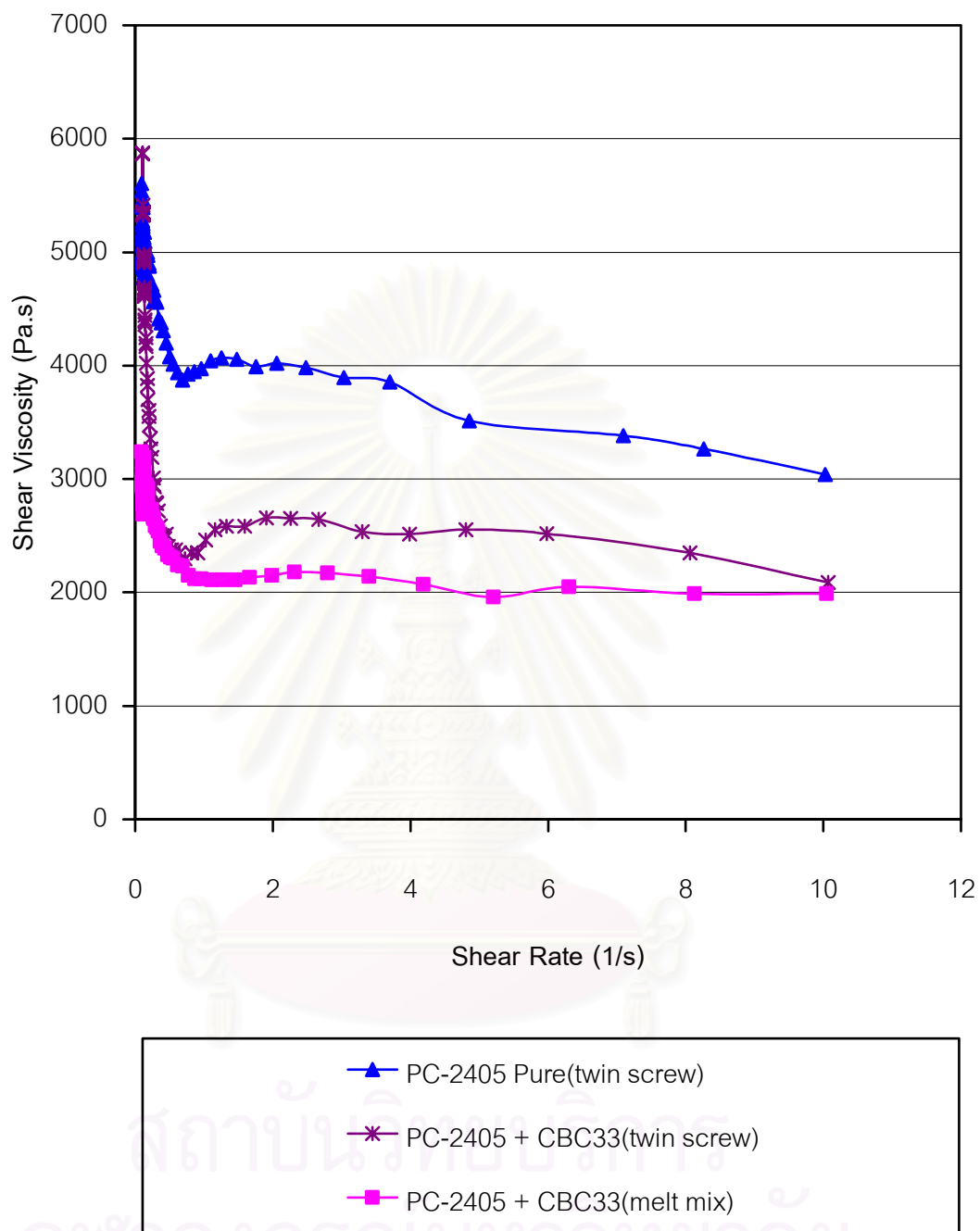

Figure 5-19 Shear Viscosity of PC-2405 blends with CBC33 by twin screw extruder versus shear rate

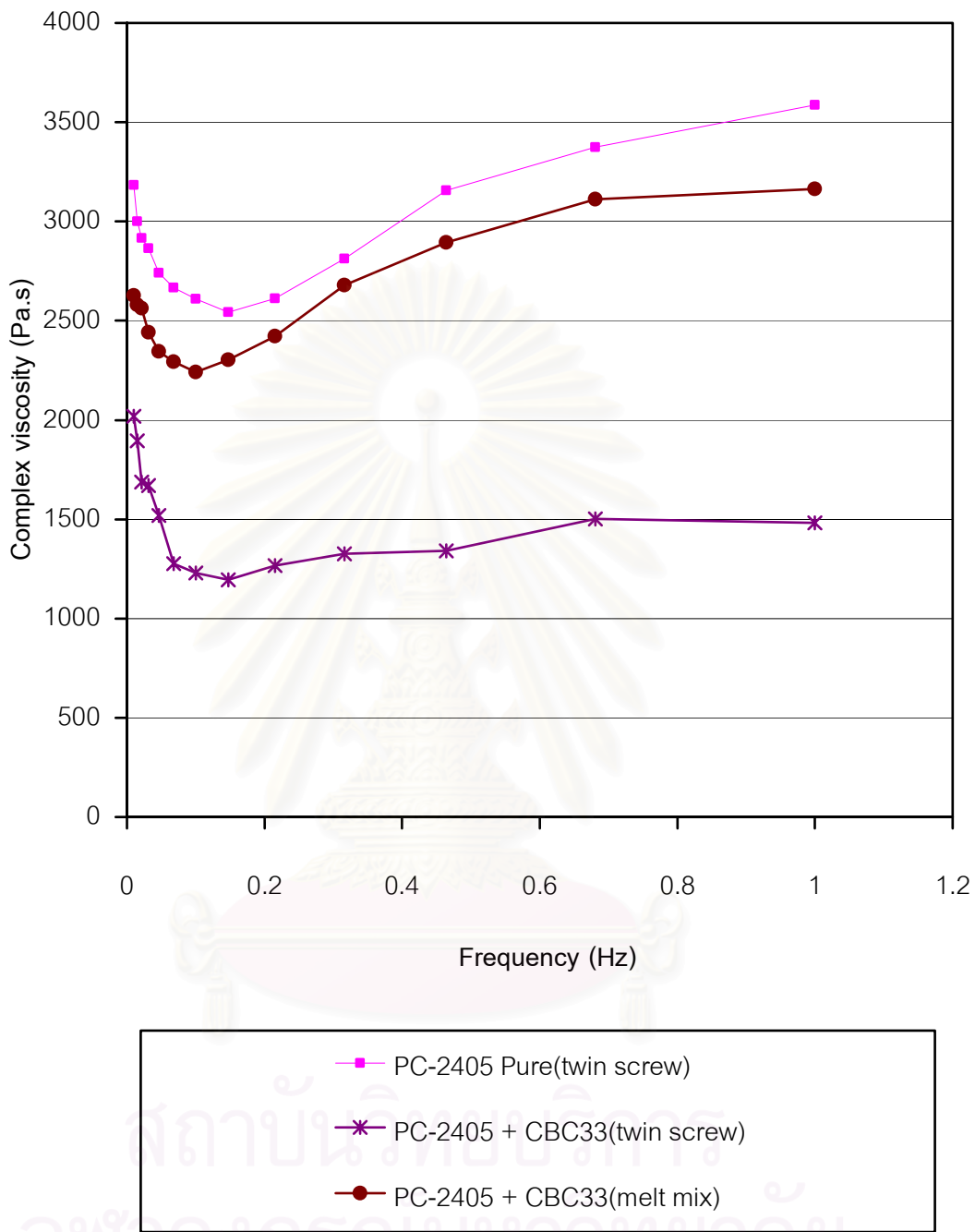

Figure 5-20 Complex Viscosity of PC-2405 blends with CBC33 by twin screw extruder versus frequency

To investigate the effects of mixing methods on the viscosity, mixing CBC33 with polycarbonates by single screw extruder and by twin screw extruder were studied. **Figures 5-13** to **Figures 5-21** show the viscosity value of PC-2600, PC-2405 blends with 0.2% wt CBC33 prepared by single screw extruder and by twin screw extruder. The viscosity values of polycarbonate blends by single screw extruder with 0.2% wt CBC33 is lower when comparing with viscosity values of the blends prepared by twin screw extruder. The results may be the effects of different mixing efficiency. Single screw extruder used in this study may provide better mixing and resulting blends have good distribution and dispersion than the blends prepared by twin screw extruder. Single screw extruder has the diameter of 19.05 mm, L/D ratio of 25:1 whereas twin screw extruder has the diameter of 20 mm and L/D ratio of 15:1. In this experiment single screw extruder has longer heated barrel surface than twin screw extruder, then polymer processed by the single screw extruder can be more effectively mixed than polymer in twin screw extruder.

The viscosities of pure PC-2600, pure PC-2600 from single screw extruder and pure PC-2600 from twin screw extruder are presented in **Figure 5-21** and **Figure 5-22**. The viscosities of pure PC-2405, pure PC-2405 from single screw extruder and from twin screw extruder are presented in **Figure 5-23** and **Figure 5-24**. The viscosity behavior of pure polycarbonate from these two mixing methods has shown only slight differences.

In general, when pure polymer were extruded from both mixing method, their viscosity tended to be lower than that of pure polymer pellets because the effects of temperature and shear in mixing methods. Then some parts of polycarbonate chain may be broken during mixing. Polycarbonate from single screw extruder has lower viscosity than twin screw extruder. The results may be effects of different mixing efficiency, time exposed to heat and shear during mixing.

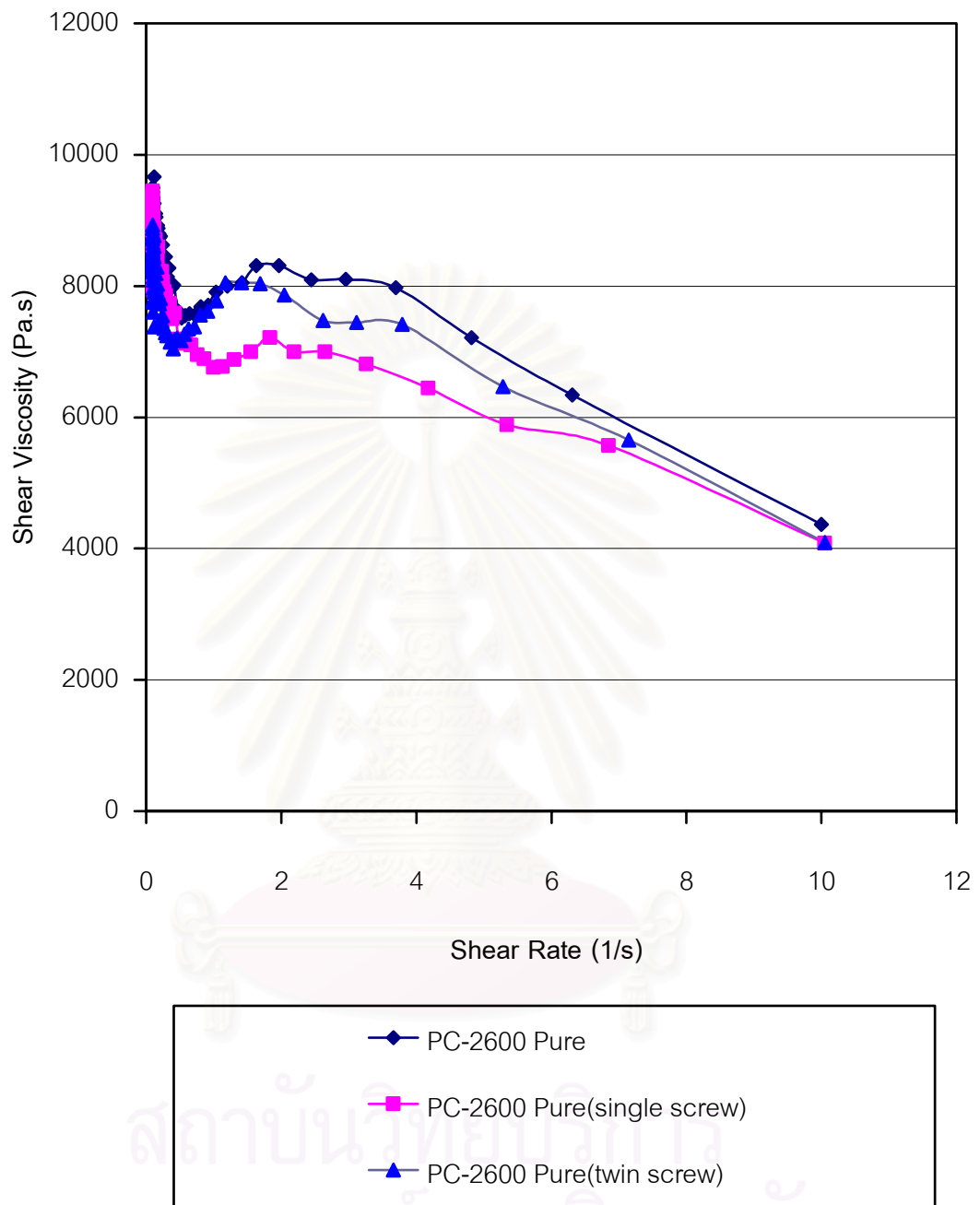

Figure 5-21 Shear Viscosity of PC-2600 pure versus shear rate.

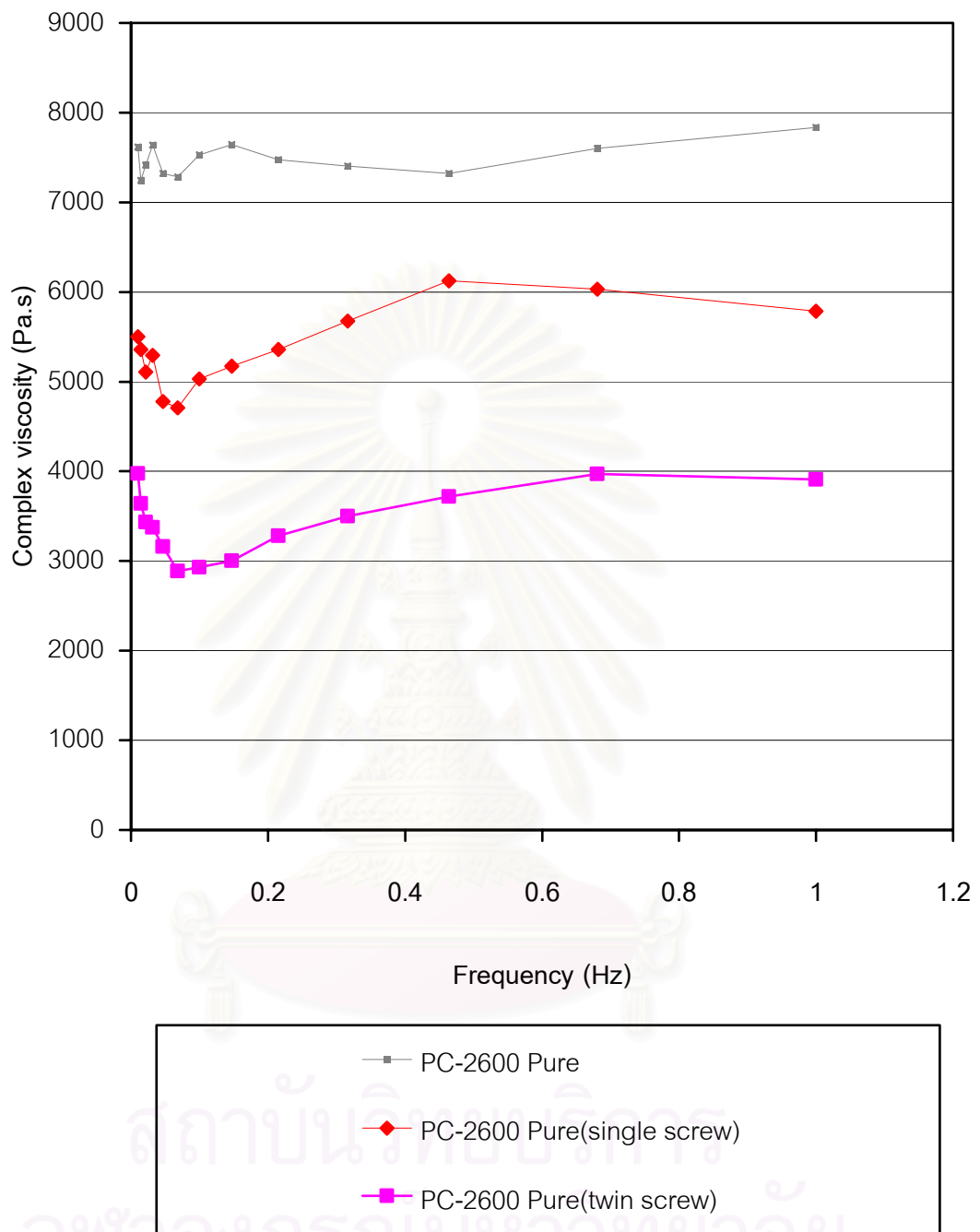

Figure 5-22 Complex Viscosity of PC-2600 pure versus frequency

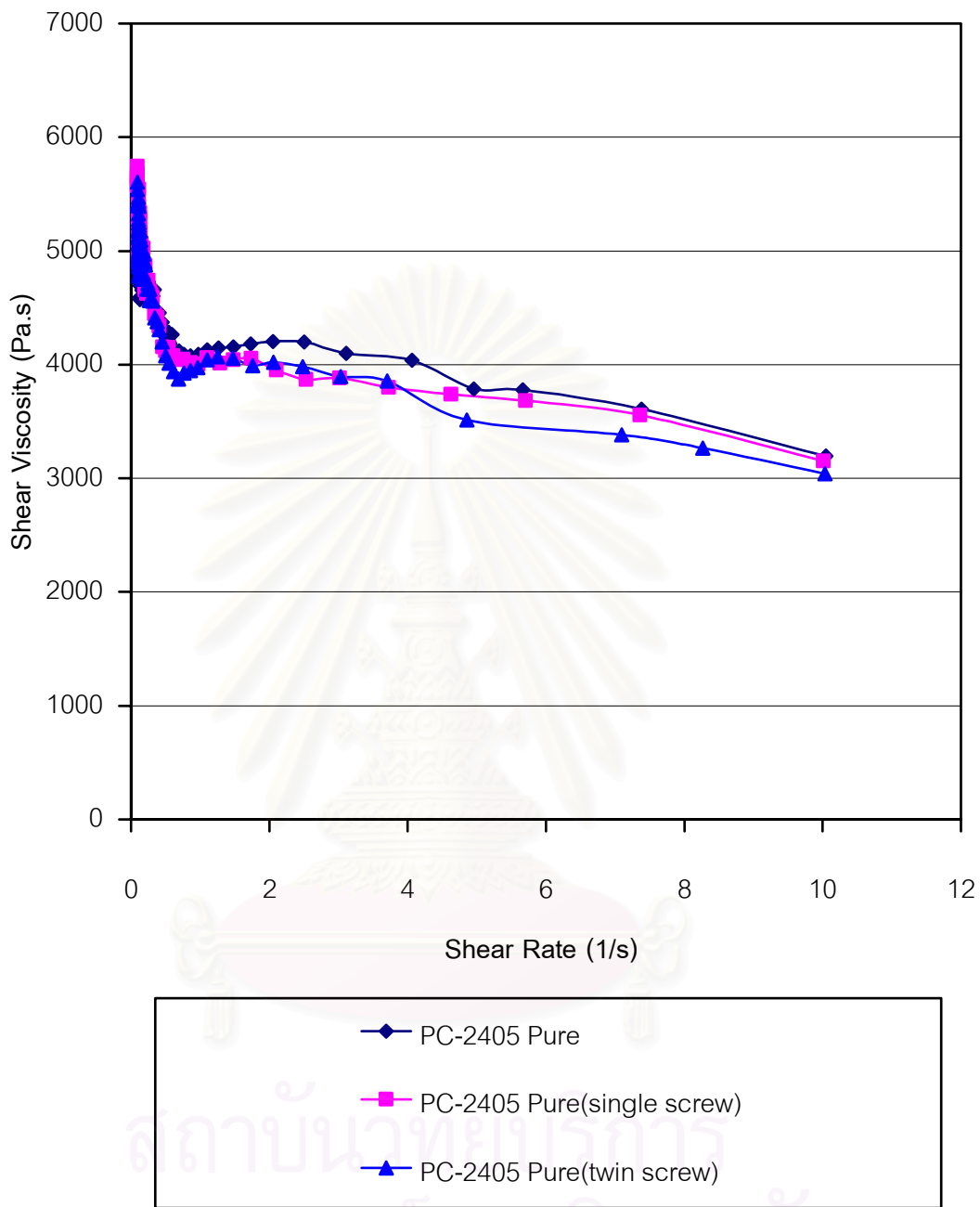

Figure 5-23 Shear Viscosity of PC-2405 pure versus shear rate.

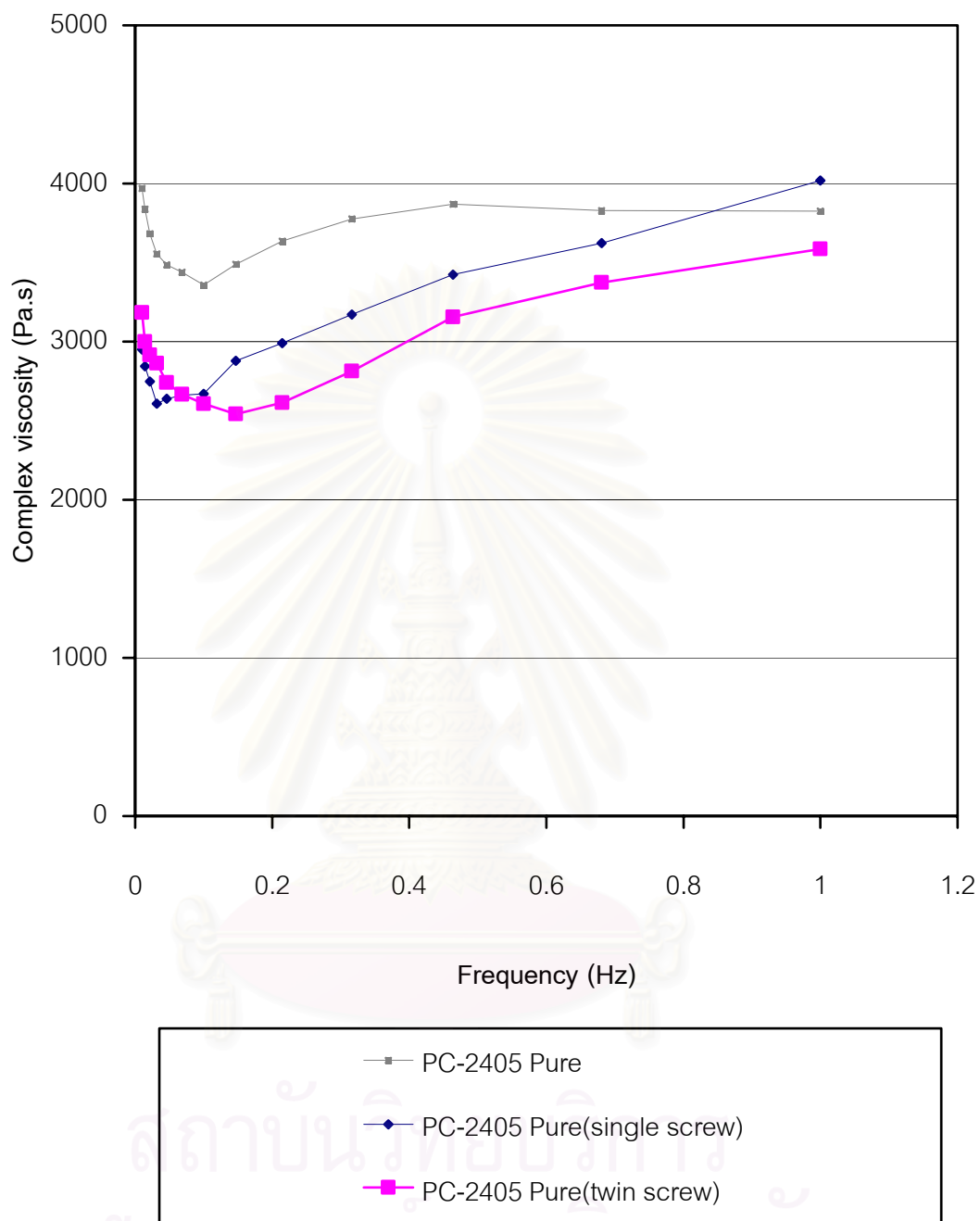

Figure 5-24 Complex Viscosity of PC-2405 pure versus frequency

5.5 Deviation of predicted viscosities from Giesekus model from the measured melt viscosities.

From Giesekus model equation 3.37,

$$\frac{\eta'}{\eta_0} = \frac{1}{1 + (\lambda\omega)^2}$$

and

$$\frac{\eta''}{\eta_0} = \frac{\lambda\omega}{1 + (\lambda\omega)^2}$$

When rearranging variables, equations are:

$$\frac{1}{\eta'} = \frac{\lambda^2 \omega^2}{\eta_0} + \frac{1}{\eta_0} \quad (5.2)$$

and

$$\frac{1}{\eta'' \omega} = \frac{1}{\eta_0 \lambda \omega^2} + \frac{\lambda}{\eta_0} \quad (5.3)$$

Upon fitting selected raw data with equation (5.2) and equation (5.3), it is found that equation (5.2) gives a negative slope which can not be divided the term $(\lambda\omega)^2$ and equation (5.3) provides the wrong value of (η_0) (far less than the appropriate value). However, the first equation gave the close to appropriated value of zero shear viscosity and the second equation gave the close to appropriated value of the relaxation time value. In the following pictures, using both values from different equations simulated graphs from the Giesekus' model. Then, this thesis uses relaxation time (λ) from equation (5.3) and zero shear viscosity from equation (5.2) in Giesekus model. From those curves, there showed some differences from the model. Anyhow, the fitted curves of Giesekus' model were wrong because of the applied constant from equation (5.2) and (5.3) (the two values did not come from the same equation). However, this simulations show the deviated properties of the viscosities from the non

linear model of Giesekus. The measured values cannot be explained by the normal nonlinear model and different from the behaviors of the normal nonlinear liquids.

From the complex viscosity [C.W. Macosko, 1994] is

$$\eta^* = (\eta' + i\eta'')^2 = \left[\left(\frac{G''}{\omega} \right)^2 + \left(\frac{G'}{\omega} \right)^2 \right]^{\frac{1}{2}} \quad (5.4)$$

In details, comparing the complex viscosity received from Giesekus model with complex viscosity received from the experiment. Pure PC-2600 and pure PC-2405 have complex viscosity close to that from model except the beginning section. In the case of PC-2600 and PC-2405 blend with the additive (CBC33 and GMS), the complex viscosity are differ from Giesekus model (Figure 5-25, 5-28, 5-31 and 5-34). The results may be an additive molecule between polymer chain has effect to the orientation and the molecule force of the polymer chain, which can relate to the modulus value. From this experiment, we found that the storage modulus (G') are the arc curve (Figure 5-26, 5-29, 5-32 and 5-35). That are not general curve for a typical polymer because G' curve should have straight line at lower frequency. That mean the blends have elastic solid behavior differ from a typical polymer. While the loss modulus (G'') (Figure 5-27, 5-30, 5-33 and 5-36) are the straight curve similar with general curve for a typical polymer.

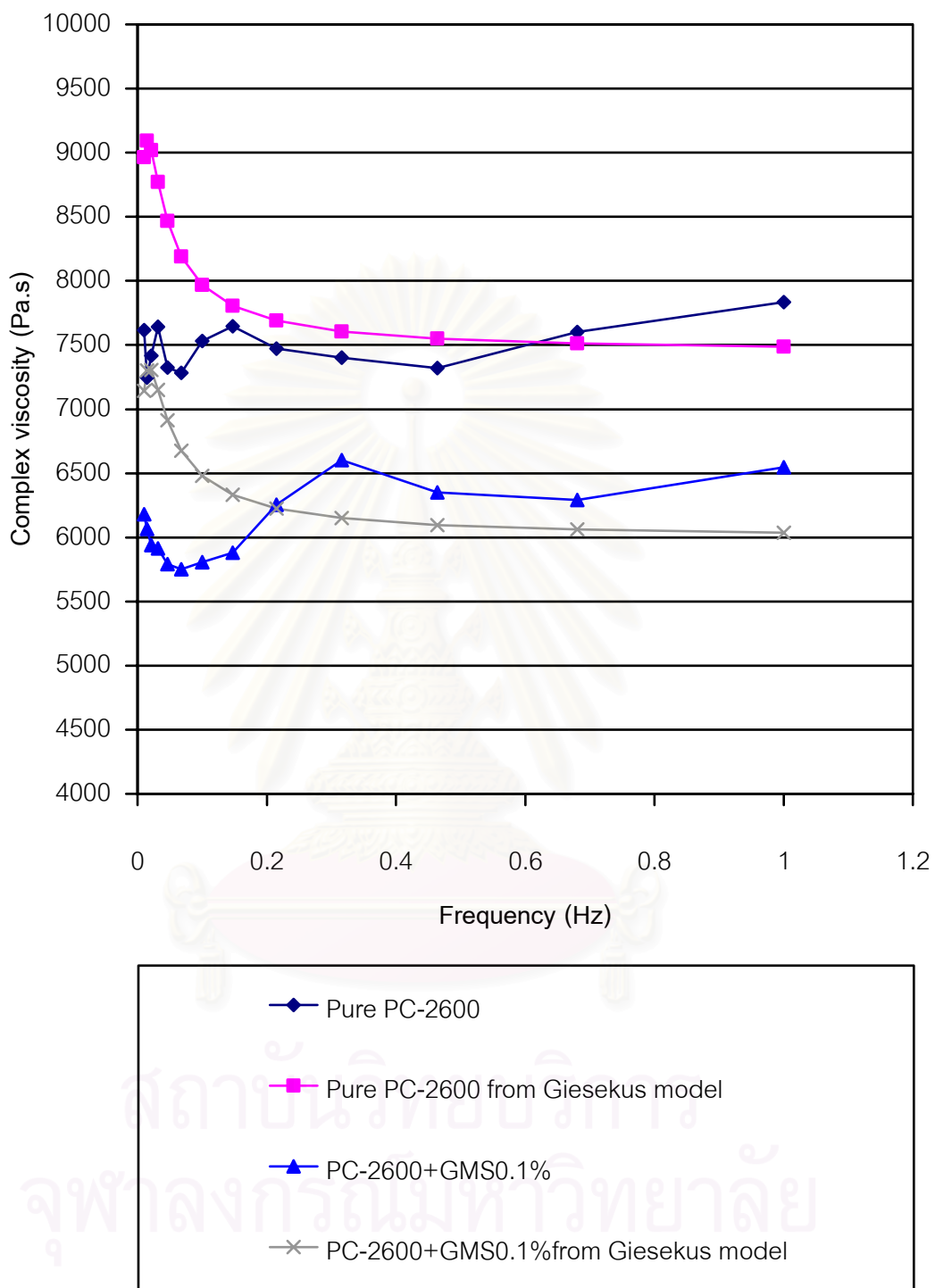

Figure 5-25 Complex viscosity of pure PC-2600, PC-2600 blend with GMS 0.1% wt and complex viscosity of pure PC-2600, PC-2600 blend with GMS 0.1% wt from Giesekus model versus angular frequency.

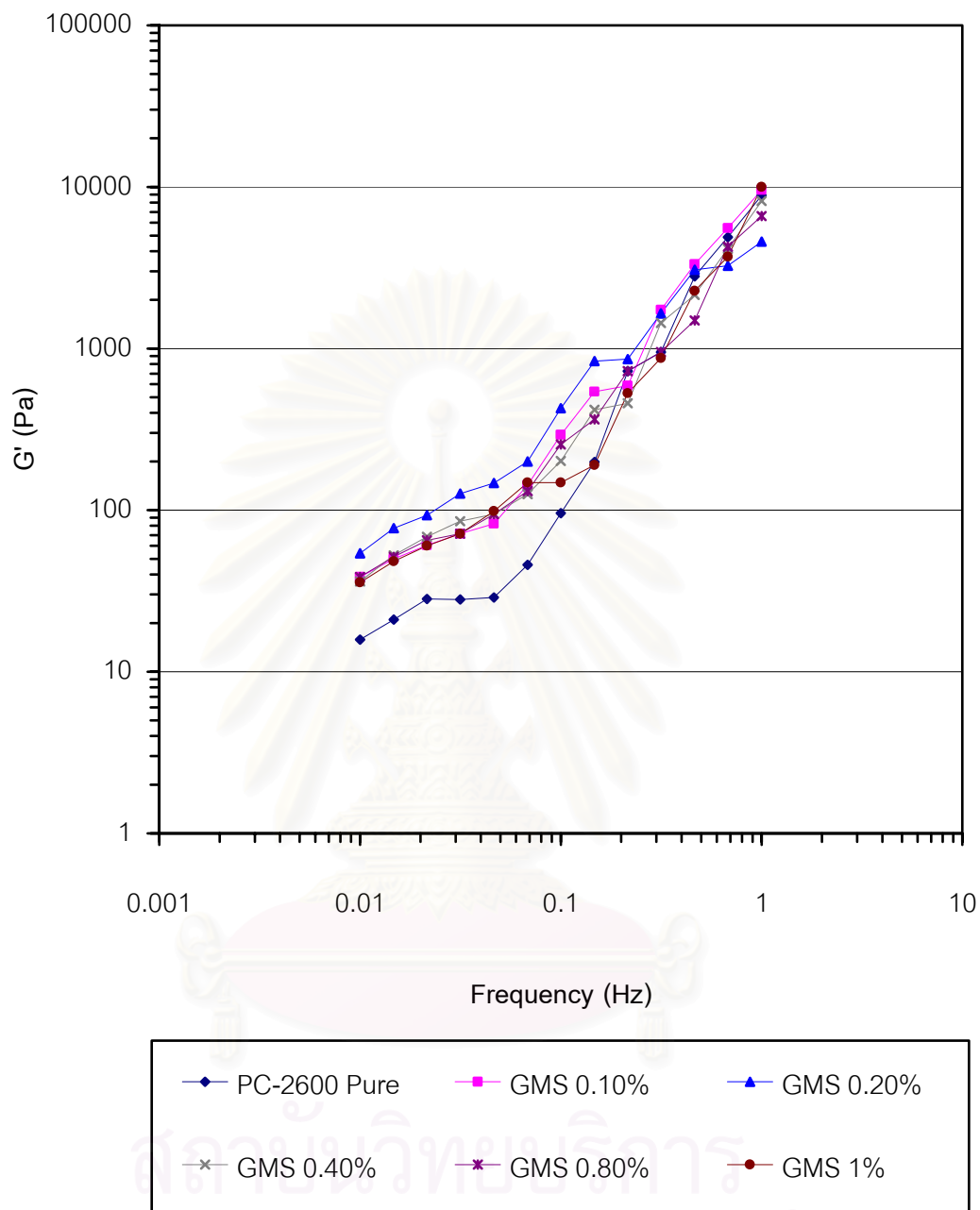

Figure 5-26 Storage Modulus of PC-2600 versus frequency at various compositions of GMS

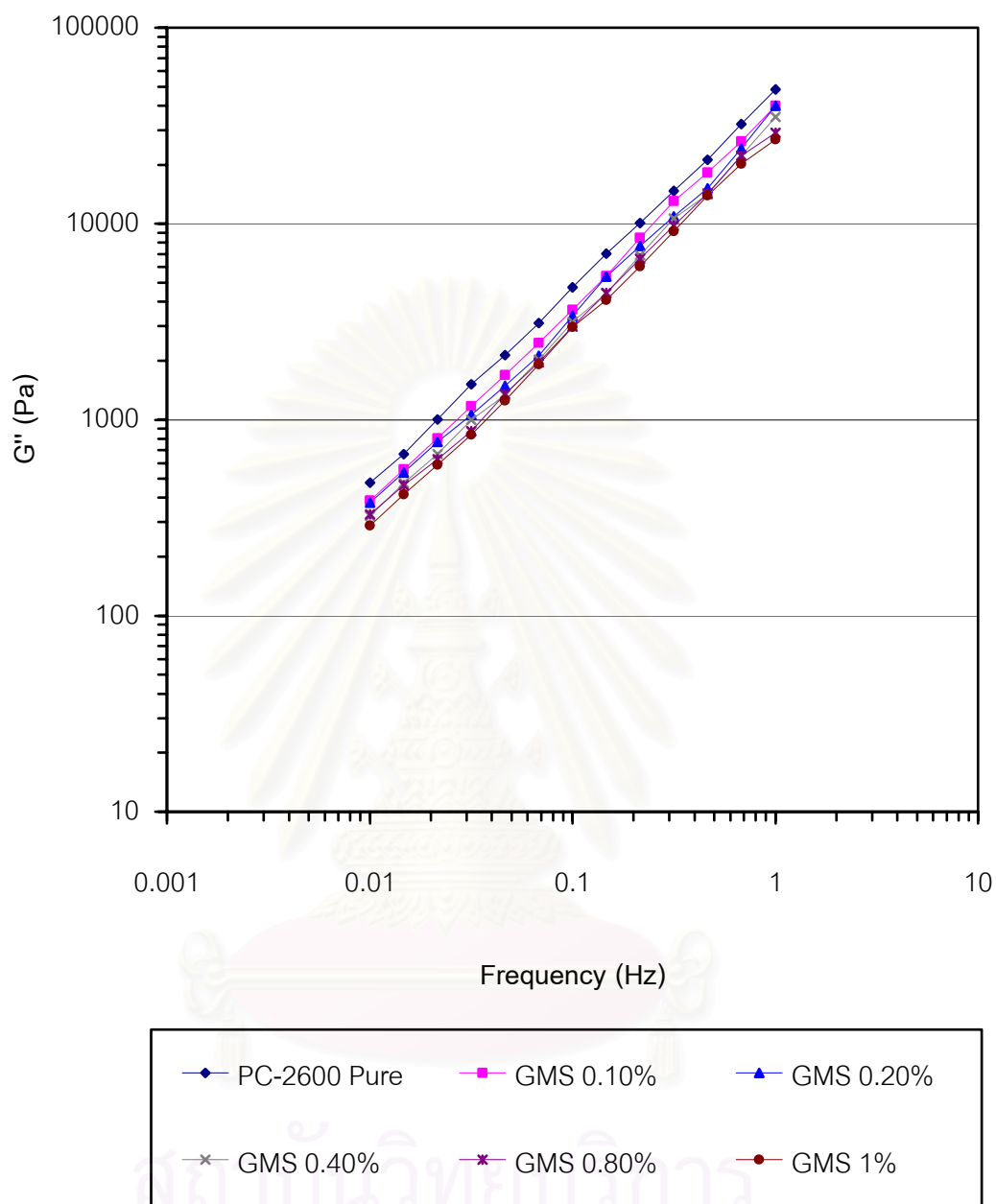

Figure 5-27 Loss Modulus of PC-2600 versus frequency at various compositions of GMS

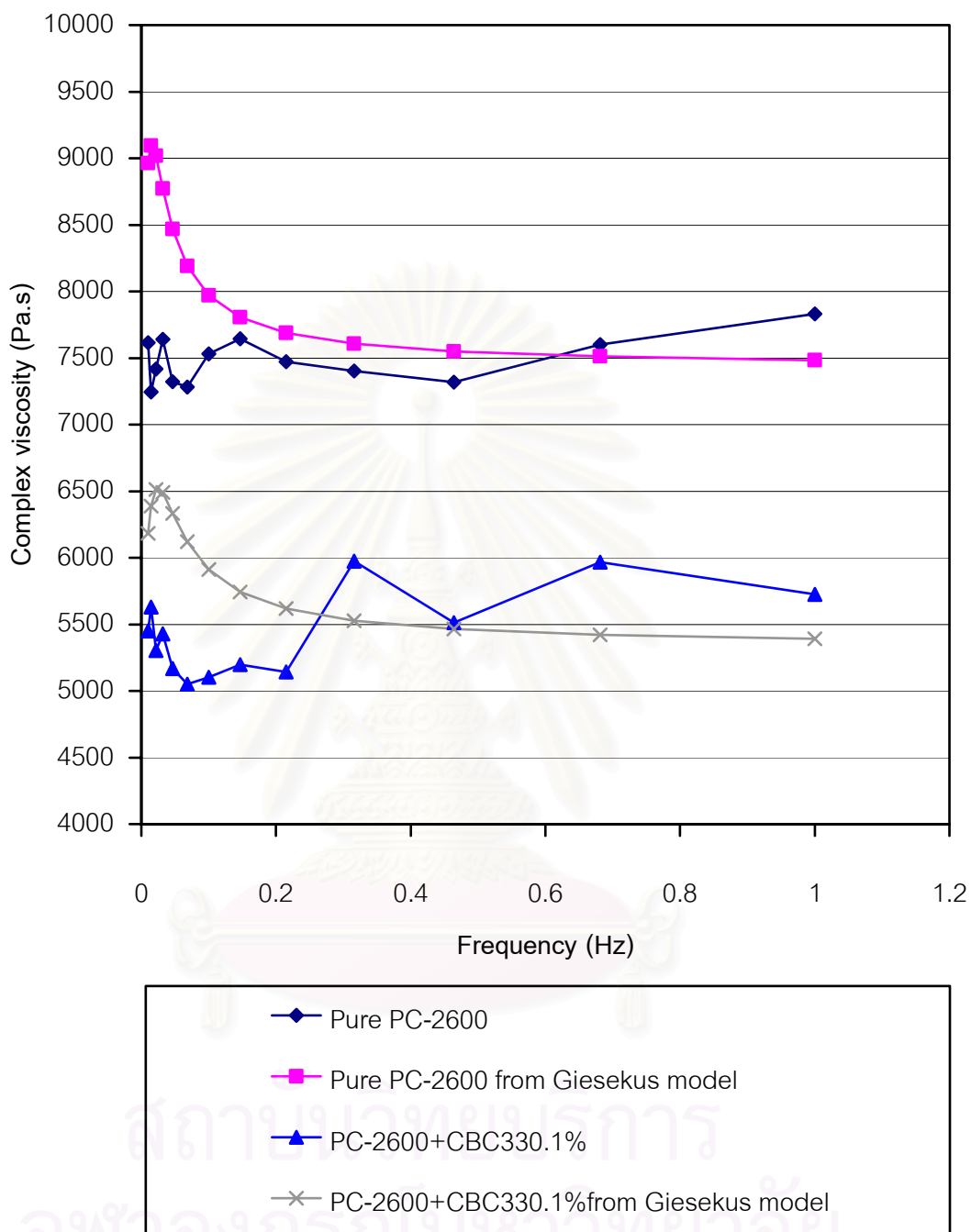

Figure 5-28 Complex viscosity of pure PC-2600, PC-2600 blend with CBC33 0.1% wt and complex viscosity of pure PC-2600, PC-2600 blend with CBC33 0.1% wt from Giesekus model versus angular frequency.

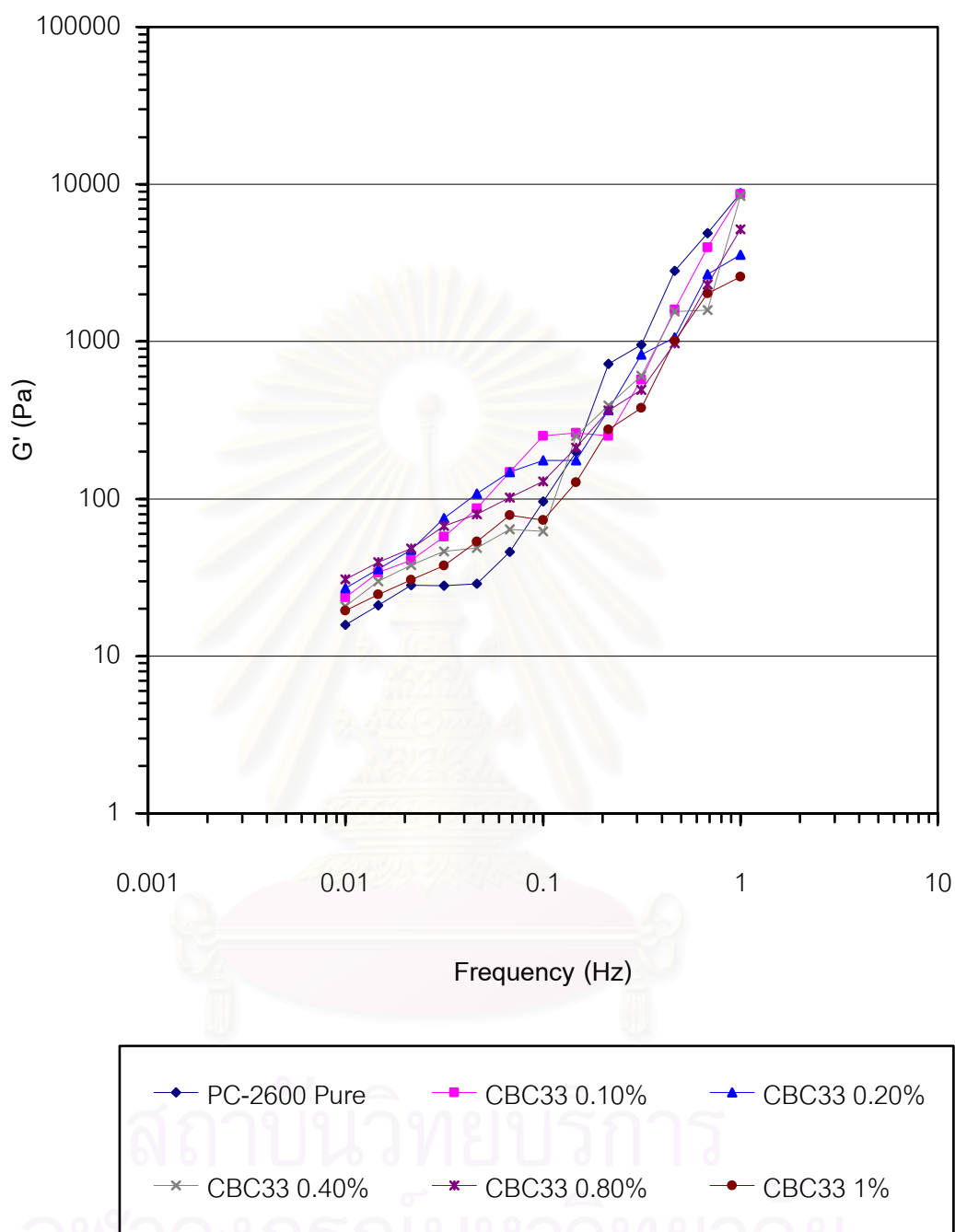

Figure 5-29 Storage Modulus of PC-2600 versus frequency at various compositions of CBC33

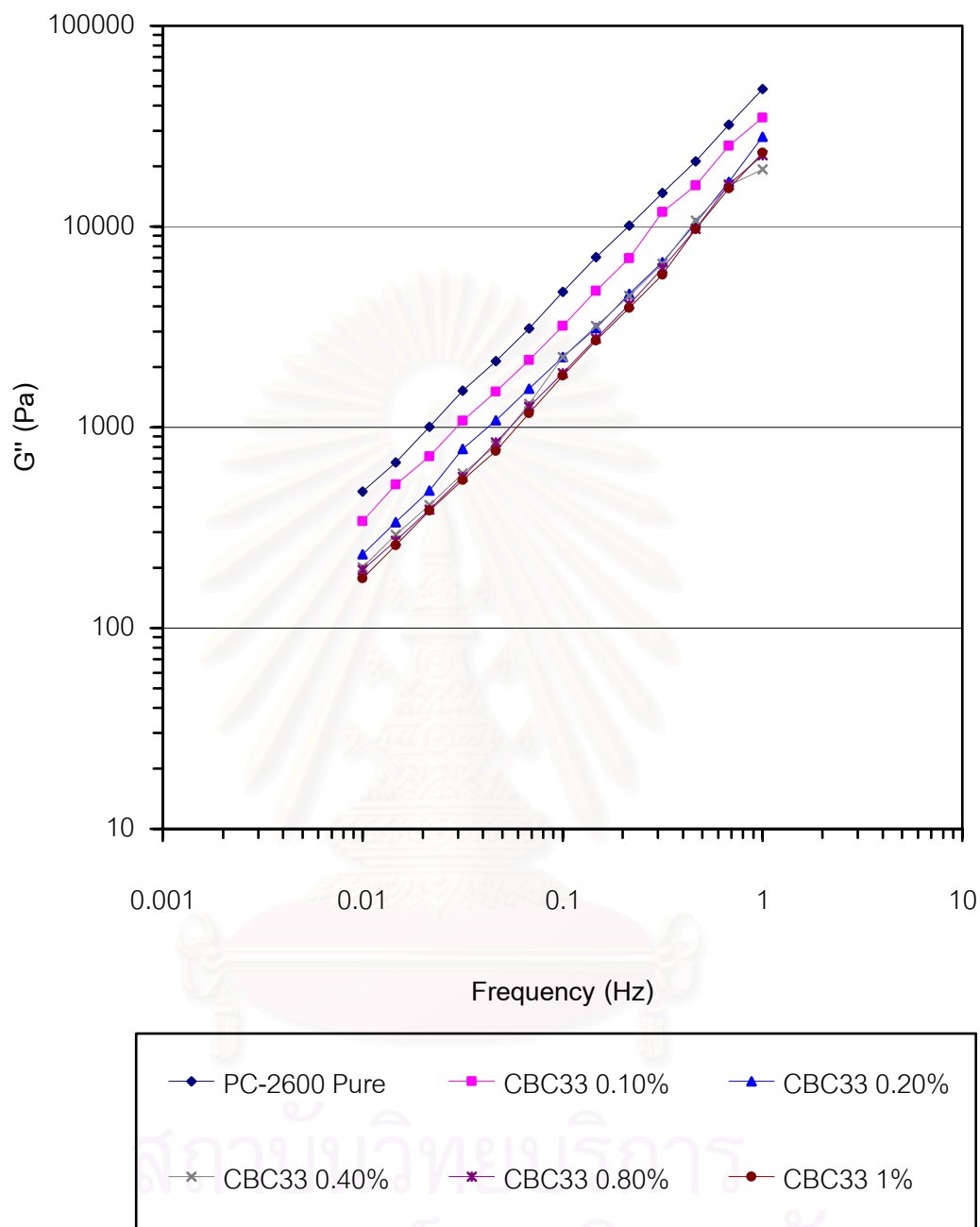

Figure 5-30 Loss Modulus of PC-2600 versus frequency at various compositions of CBC33

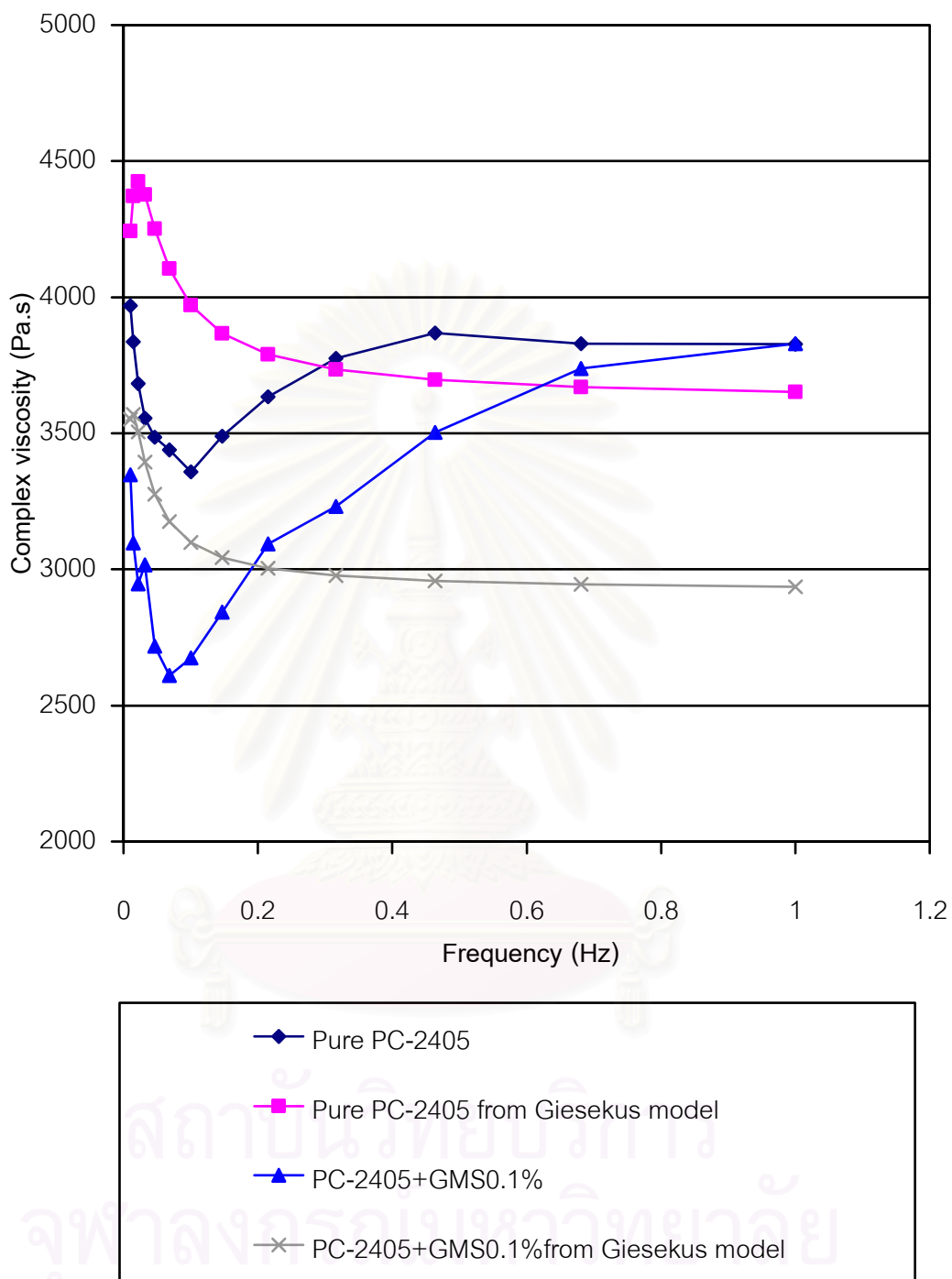

Figure 5-31 Complex viscosity of pure PC-2405, PC-2405 blend with GMS 0.1% wt and complex viscosity of pure PC-2405, PC-2405 blend with GMS 0.1% wt from Giesekus model versus angular frequency.

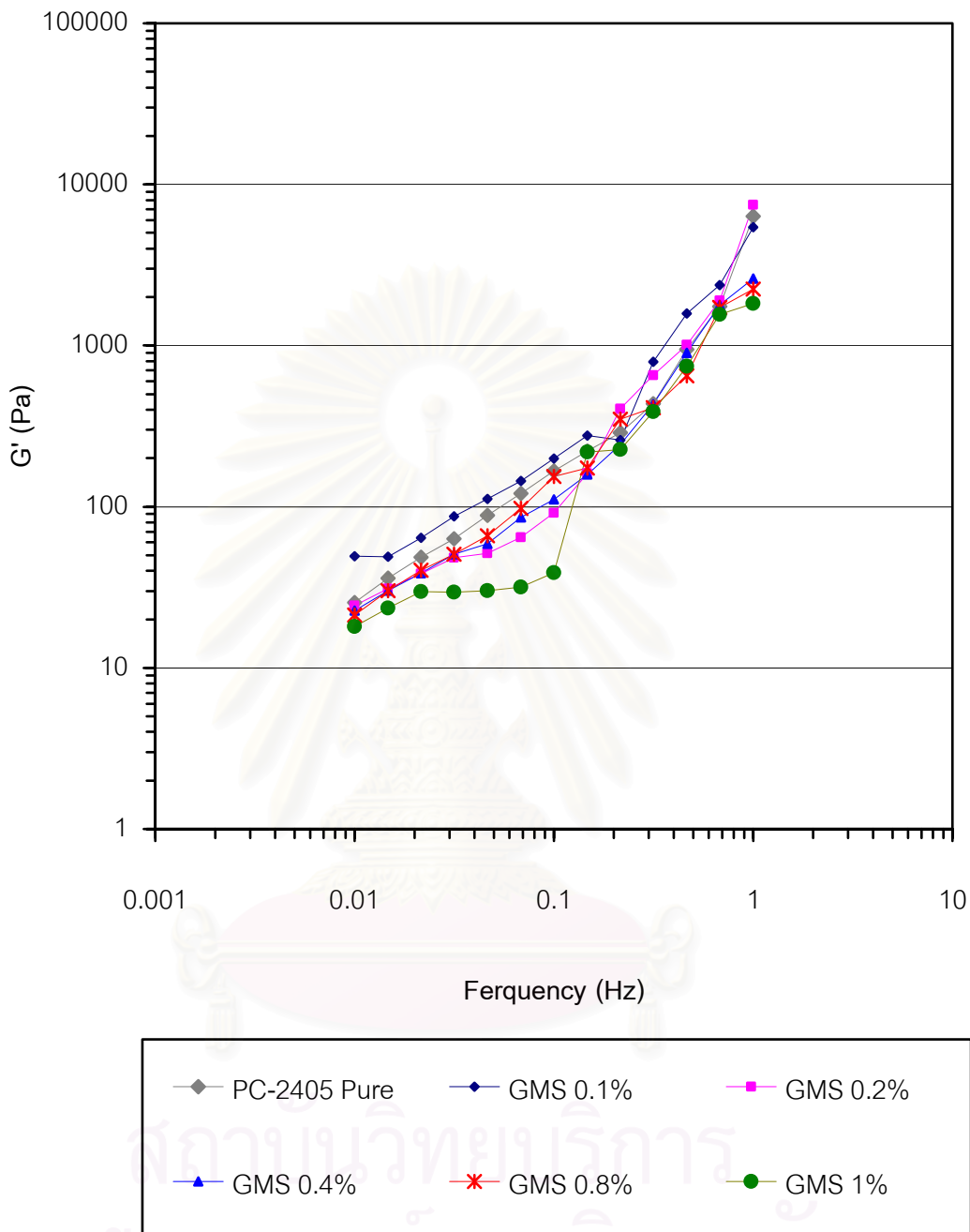

Figure 5-32 Storage Modulus of PC-2405 versus frequency at various compositions of GMS

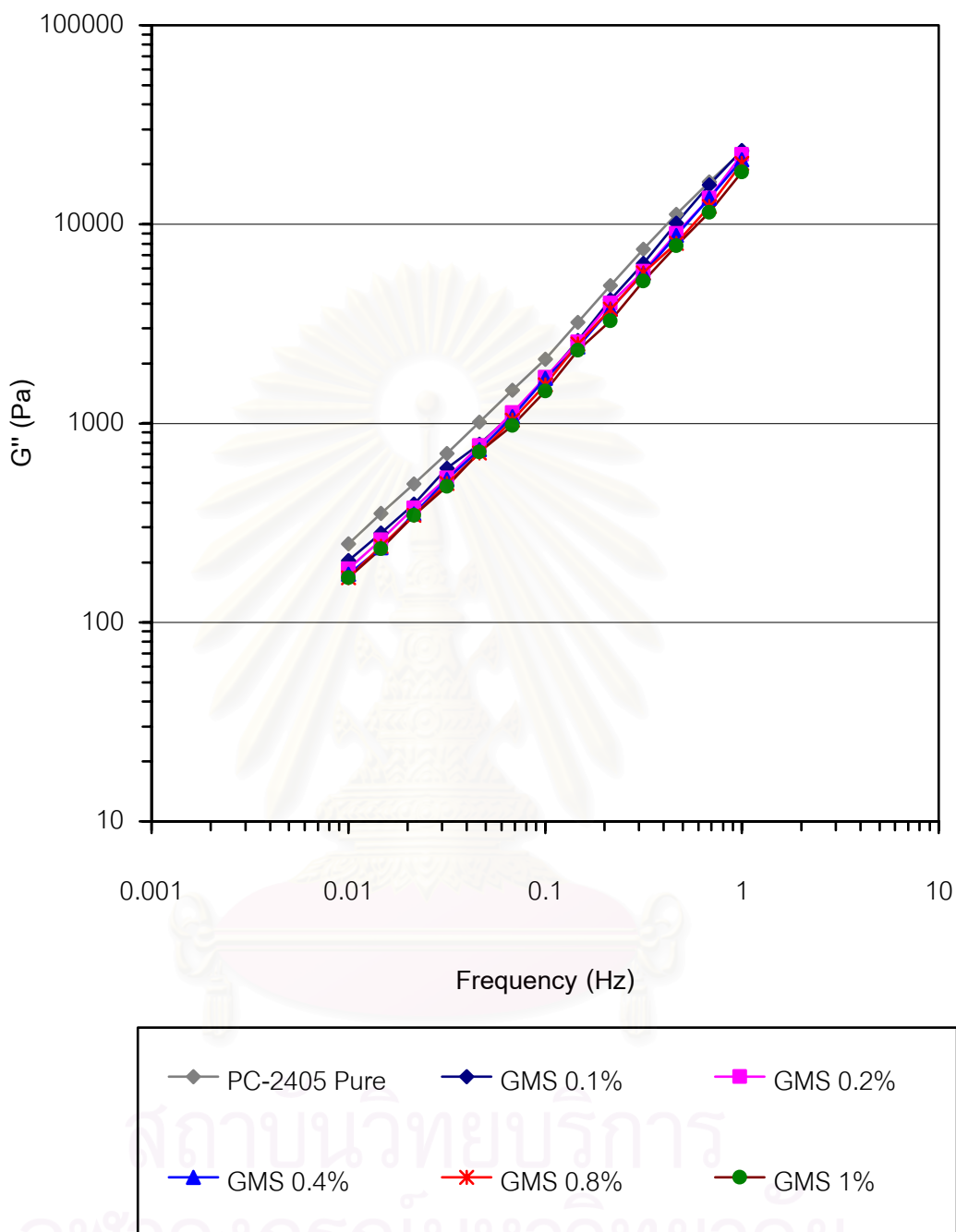

Figure 5-33 Loss Modulus of PC-2405 versus frequency at various compositions of GMS

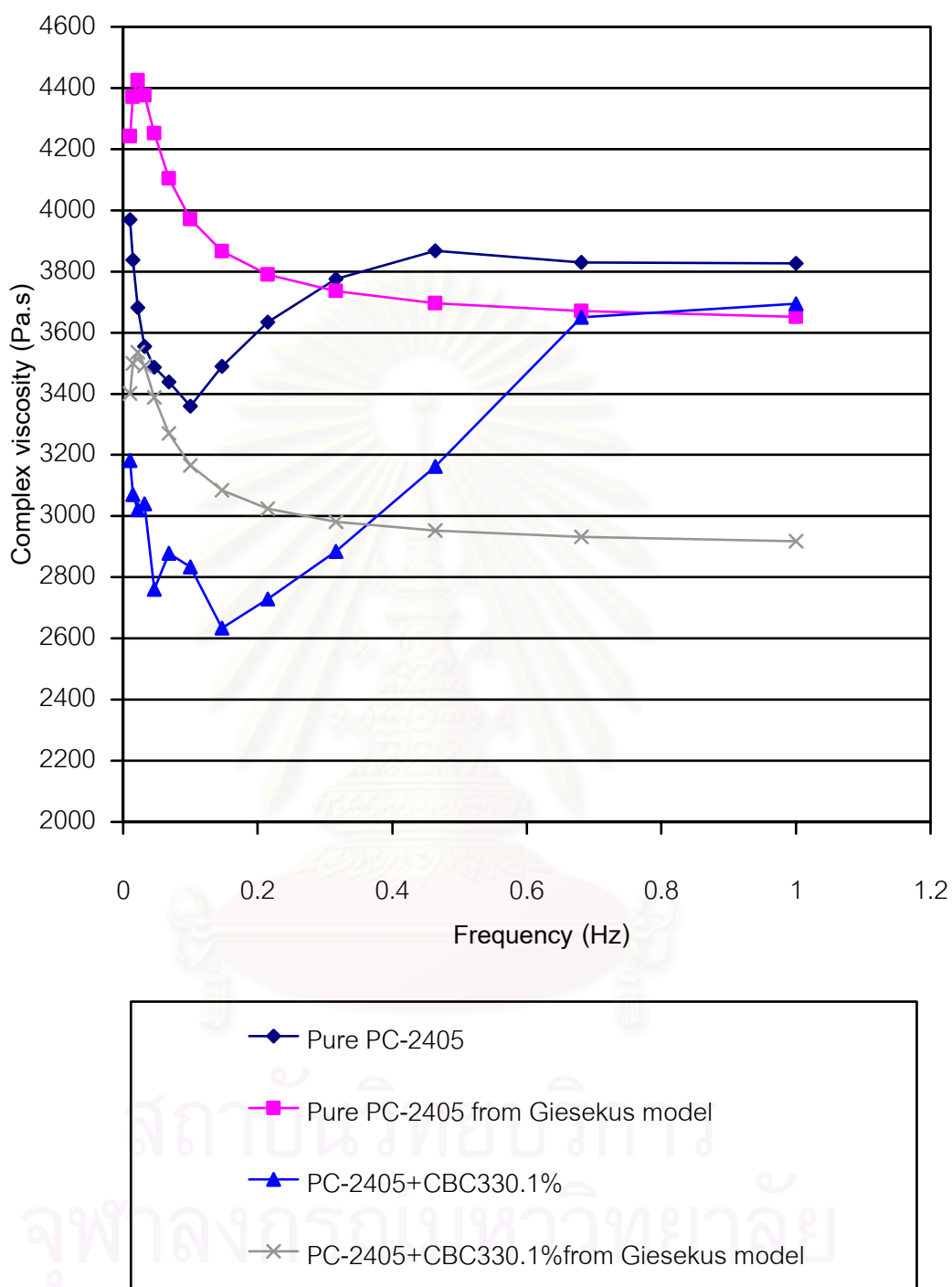

Figure 5-34 Complex viscosity of pure PC-2405, PC-2405 blend with CBC33 0.1% wt and complex viscosity of pure PC-2405, PC-2405 blend with CBC33 0.1% wt from Giesekus model versus angular frequency.

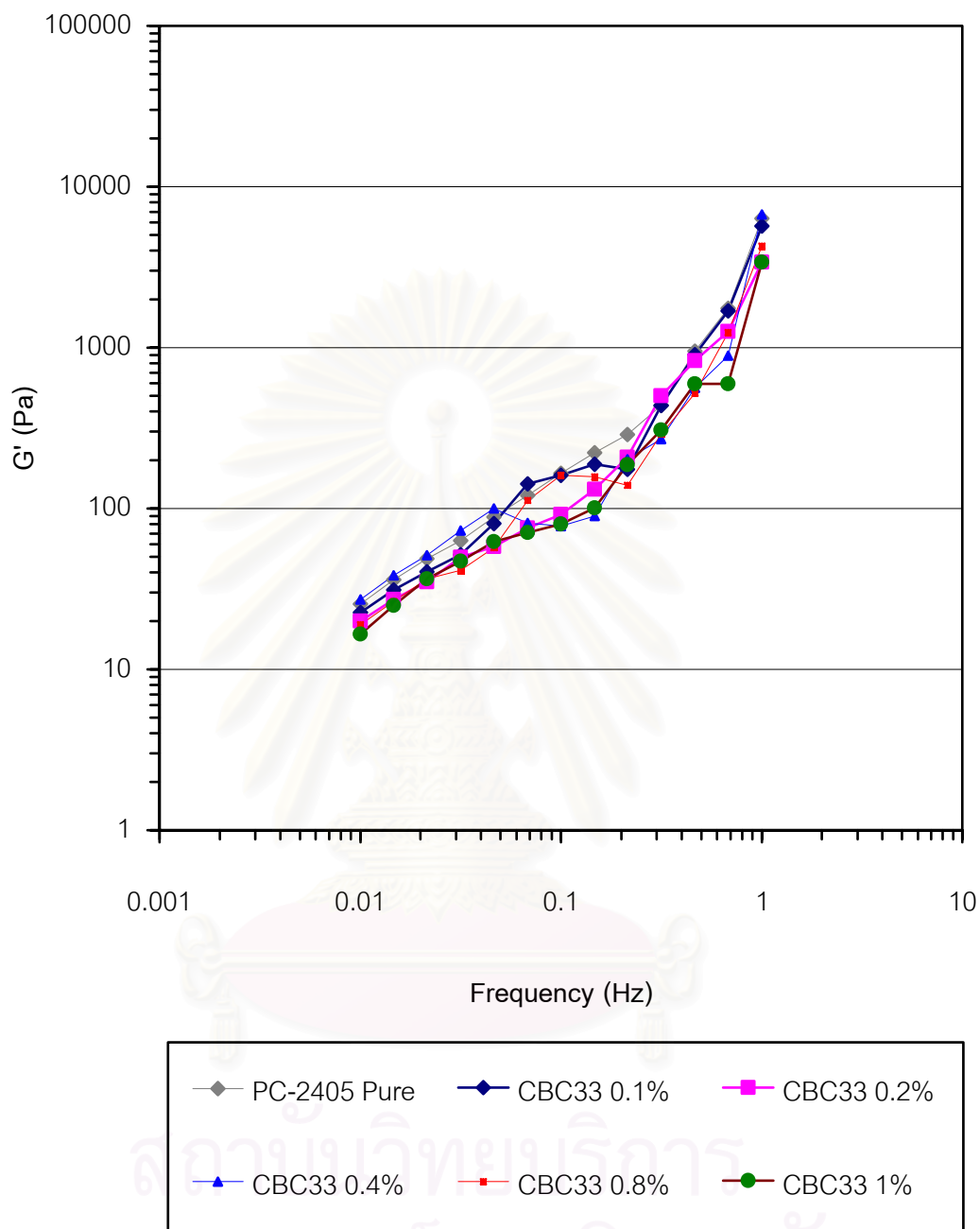

Figure 5-35 Storage Modulus of PC-2405 versus frequency at various compositions of CBC33

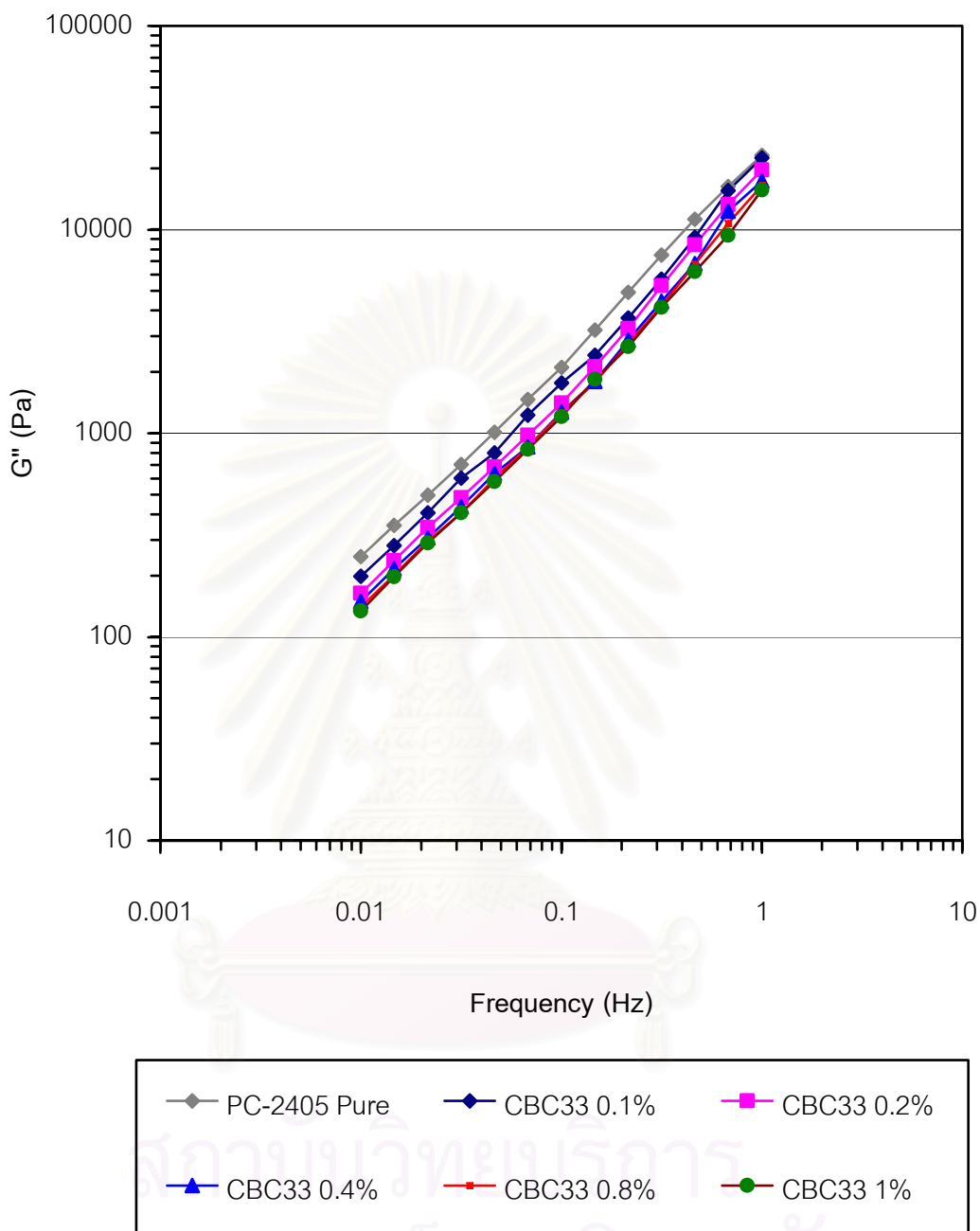

Figure 5-36 Loss Modulus of PC-2405 versus frequency at various compositions of CBC33

5.6 Injection moulding facts that results from melt viscosity measurements.

The pellets mixed from single screw and twin screw extruder were used in injection moulding. The runner from injection moulding was used in order to study the viscosity.

Shear viscosity and complex viscosity of PC-2600 from injection moulding are shown in **Figure 5-37** and **Figure 5-38**. Shear viscosity and complex viscosity of PC-2405 from injection moulding are shown in **Figure 5-39** and **Figure 5-40**. **Figure 5-37** to **Figure 5-40** shown that CBC33 has slight effects to reduce viscosity of PC-2600 and PC-2405. These results are contradict data from literature review [Chuenchaokit, A., 1998] that were determined viscosities by capillary rheometer. The viscosity of remix in capillary rheometer that have high shear rate in the same range with shear rate from injection moulding, can significantly reduce viscosity.

In addition, these results are also contradict torque value [Kunprasert, A., 2002]. The torque values from remix are lower than the torque from pure polycarbonate significantly. Therefore the viscosity from injection moulding should more reduce.

These results may be the effects of CBC33 accumulation at mould part, gate even in the injection moulded product. Then the runner parts have the concentration of CBC33 lower than 0.2% wt, so it can reduce the viscosity less than it should be.

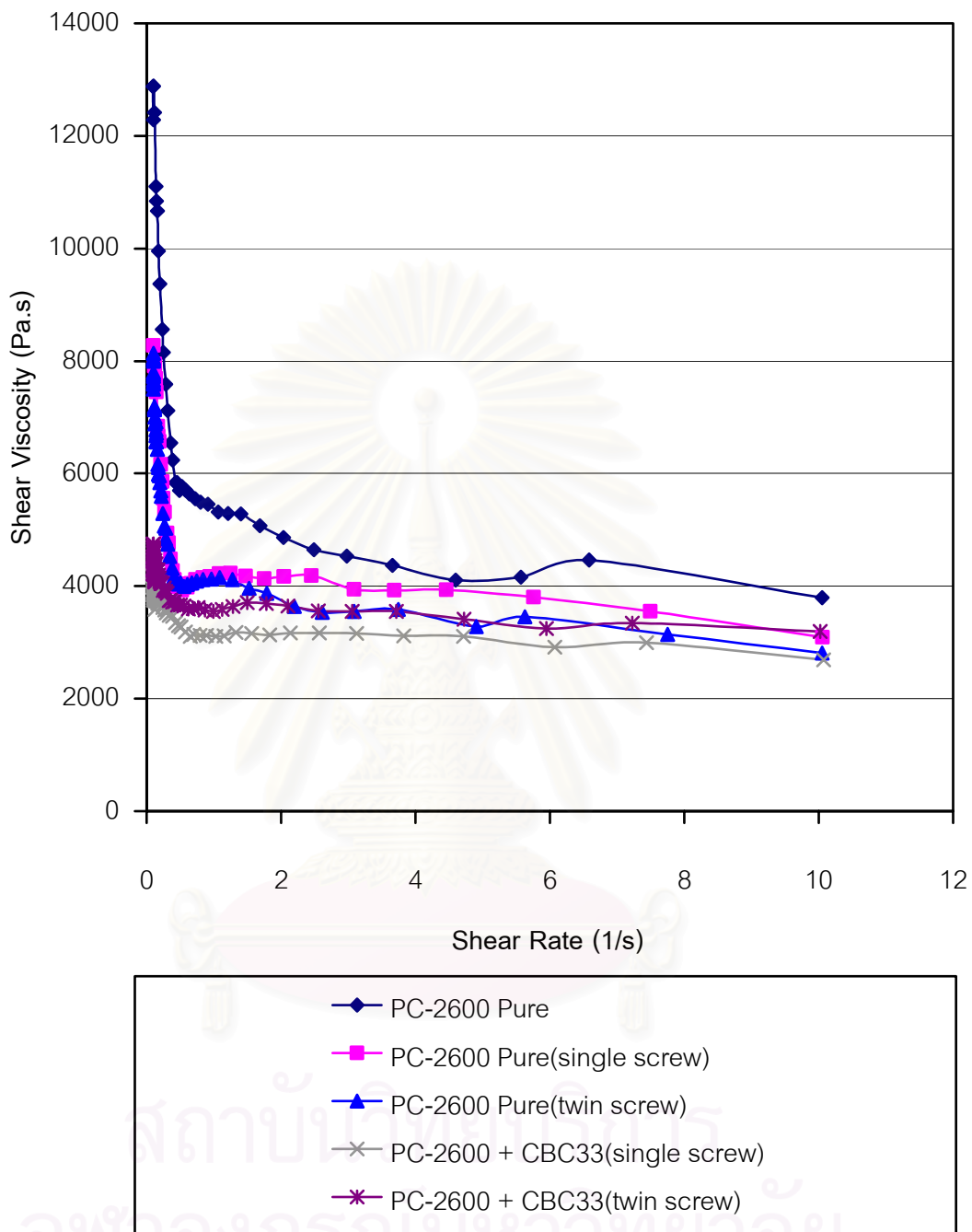

Figure 5-37 Shear Viscosity of PC-2600 products from injection molding versus shear rate

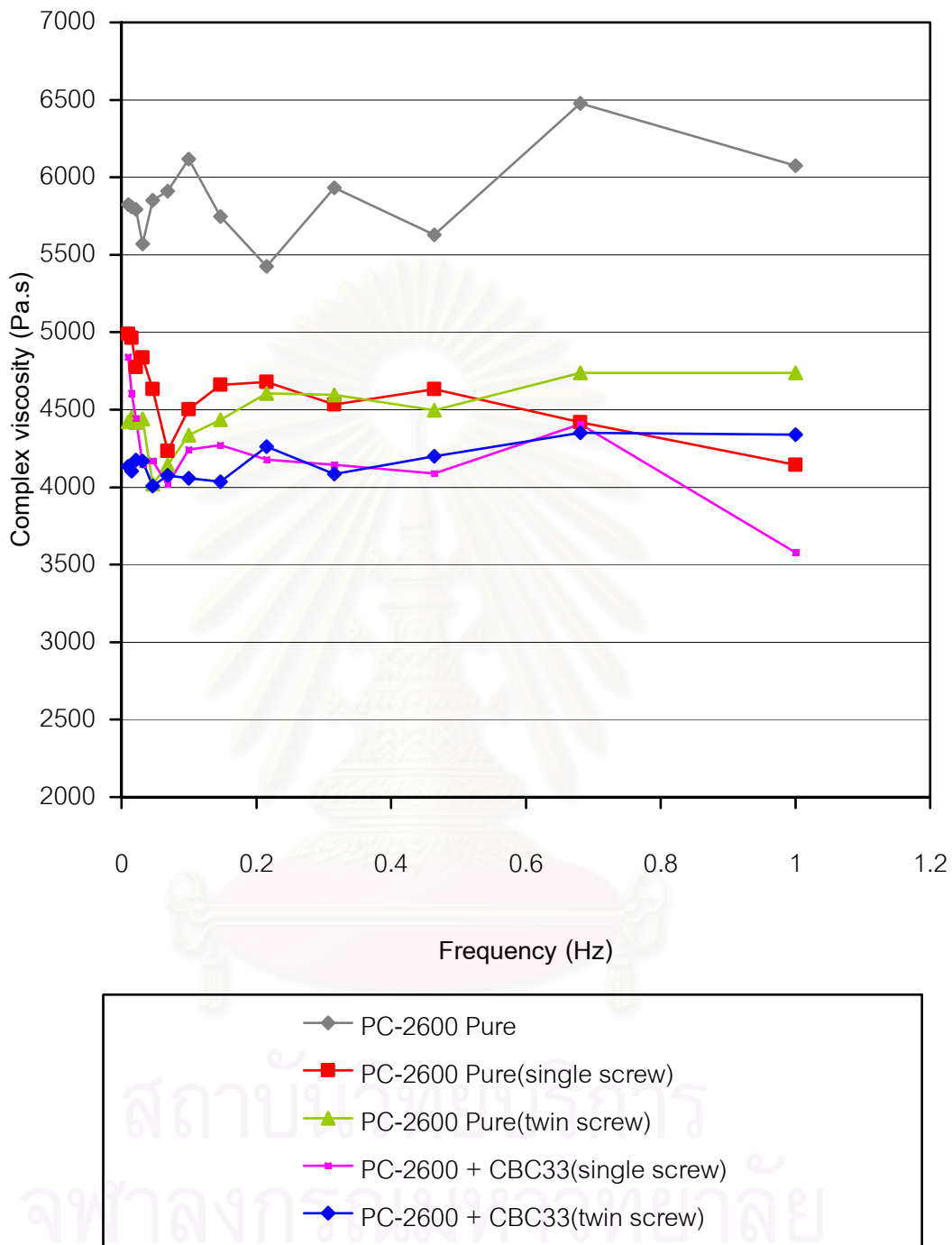

Figure 5-38 Complex Viscosity of PC-2600 products from injection molding versus frequency

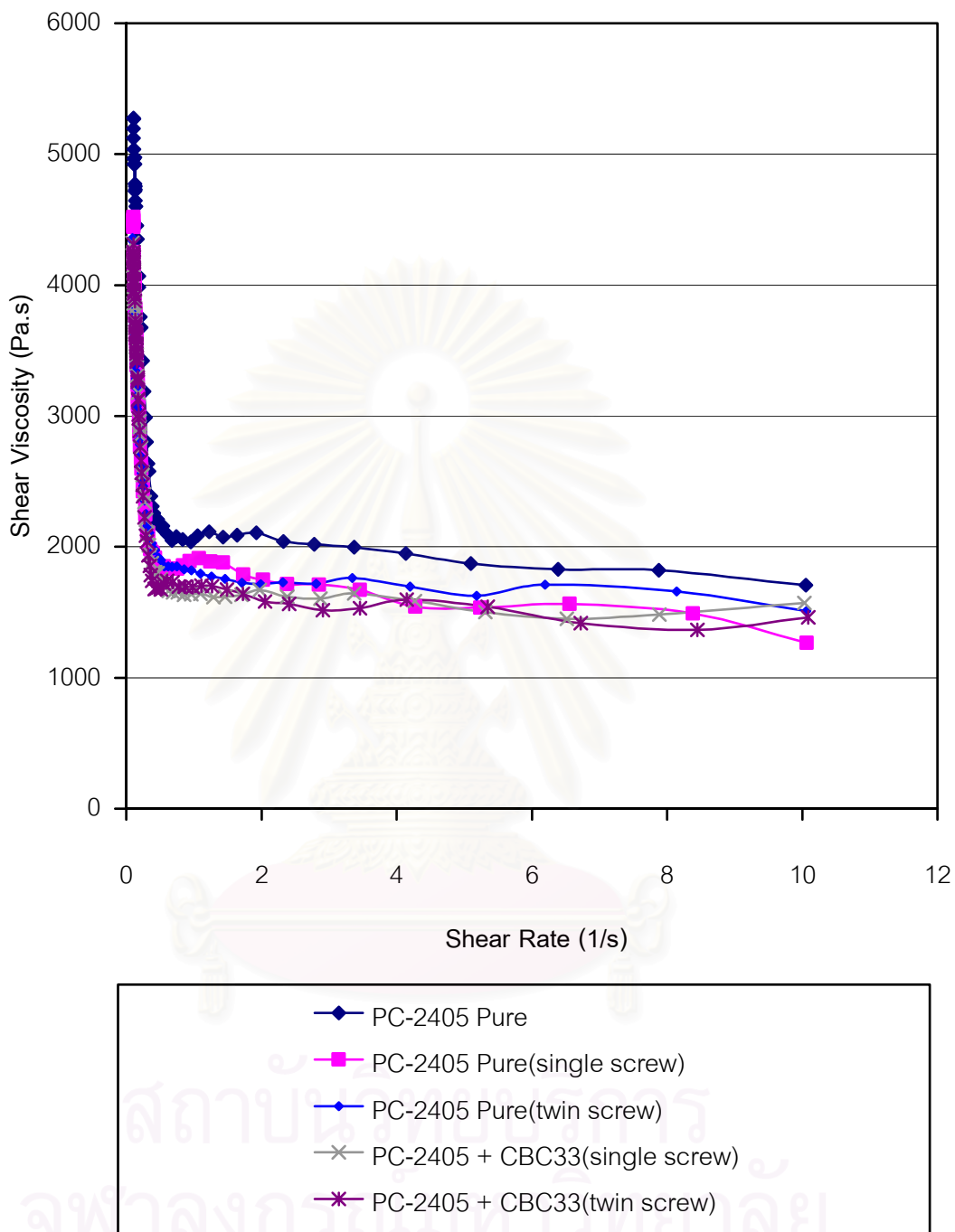

Figure 5-39 Shear Viscosity of PC-2405 products from injection molding versus shear rate

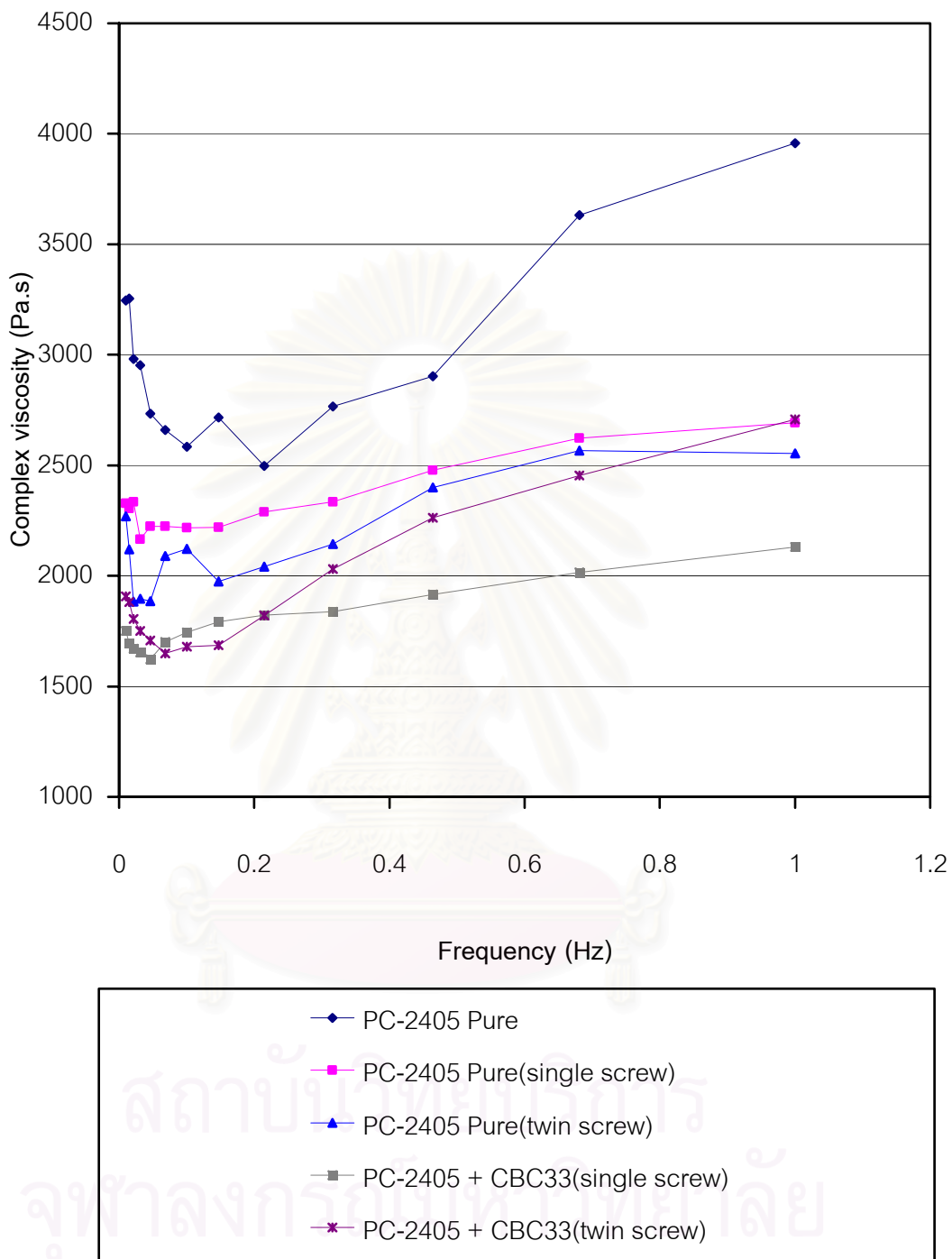

Figure 5-40 Complex Viscosity of PC-2405 products from injection molding versus frequency

5.7 Melt Flow Index, melt viscosities and the roles of mixing methods.

Melt flow indices (MFI) of pure Polycarbonates [PC-2600 and PC-2405] and the Polycarbonate blends were determined using A CEAST melt flow indexer. Tests were performed at 300 °C, using 2.16 kg. weight according to ASTM D1238.

Table 5-1 The Melt Flow Index of pure Polycarbonates and Polycarbonate blends with single screw extruder and twin screw extruder.

Polymer	MFI (g/10 min)
PC-2600 pure	19.9
PC-2600 pure by single screw extruder	20.0
PC-2600 + 0.2% CBC33 by single screw extruder	21.7
PC-2600 pure by twin screw extruder	20.4
PC-2600 + 0.2% CBC33 by twin screw extruder	21.5
PC-2405 pure	23.1
PC-2405 pure by single screw extruder	23.5
PC-2405 + 0.2% CBC33 by single screw extruder	30.0
PC-2405 pure by twin screw extruder	23.1
PC-2405 + 0.2% CBC33 by twin screw extruder	28.1

The melt flow indexer is the common capillary instrument used in the polymer industry. Melt flow indexer resemble a capillary rheometer except it has only one driving pressure from specified mass and data is obtained in weight unit. While the capillary rheometer has a hydraulic piston used to generate the increasing pressure, pressure drop and flow rate through capillary die are used to determine viscosity.

From Table 5-1 the melt flow index of pure PC-2600 are lower than melt flow index of pure PC-2405. The viscosities of pure PC-2600 are higher than pure PC-2405, according to the theory in page 45. High melt flow index value generally indicates low viscosity and low molecular weight material.

PC-2600 blends with 0.2% CBC33 by single screw extruder has higher melt flow index than pure PC-2600 about 8.5%. PC-2600 blends by twin screw extruder has higher melt flow index than pure PC-2600 about 5.4%. In the case of PC-2405, PC-2405 blends prepared by single screw extruder, they have higher melt flow indices than pure PC-2405 passed through single screw extruder about 27.7%. PC-2405 blends by twin screw extruder has higher melt flow index than pure PC-2405 passed through twin screw extruder about 21.6%

PC-2600 and PC-2405 blends prepared by single screw extruder show larger increments of melt flow index values than those prepared by twin screw extruder. This result may be the effects of different mixing efficiency between single screw extruder and twin screw extruder used in this study.

In this experiment, it is possible samples prepared by the single screw extruder may be better mixed and LCC is well distributed than that prepared by the twin screw extruder. Blend samples prepared by single screw extruder tend to processed under twin screw extruder.

Chapter 6

Conclusions and Recommendations

6.1 Conclusions

The objective of the work reported in this thesis was to investigate the effects of mixing and processing conditions on the melted viscosity of Polycarbonate blends with low molar mass liquid crystal chemical. CBC33 has been applied to two type of Polycarbonate at only small concentration to create the binary blend of base Polycarbonate and CBC33. Stirring melt mix, mixing by single screw extruder and mixing by twin screw extruder were the method to blend the Polycarbonate and CBC33. The viscosity behaviors of pure Polycarbonate and their blends were observed by parallel plate rheometric measurement and melt flow index test machine. The study of the recycling possibilities were also performed. The conclusions from this research can be summarized as follows:

1. The addition of CBC33 to base Polycarbonate by stirred melt mixer can reduce melt viscosities of the blends. It is found that 0.2% by weight is the suitable concentration because at higher concentration, the effects of CBC33 in reducing viscosities of polymer blends are less pronounced compared with lower concentration.
2. Compared with viscosity of pure polycarbonate, the viscosity value of polycarbonate blends with CBC33 shows a larger decrease than that of polycarbonate blends with GMS at the same percent composition.
3. The addition of CBC33 and GMS to base polycarbonate affects the increasing of non-linear viscoelastic behavior which can be seen from the deviation from Power Law model and Giesekus model in the pseudo plastic range.

4. The viscosity value of polycarbonate blends with 0.2% by weight of CBC33 prepared by single screw extruder are the lowest when comparing with polycarbonate blends by stirring melt mix and twin screw extruder at the same percent composition.
5. The viscosity value of polycarbonate blends with 0.2% by weight of CBC33 from injection moulding are close to the viscosity value of pure polycarbonate from injection moulding.
6. The mixing method and the molecular weight of polymer base directly affect to the changing of melt flow index value of the resulting ble.
7. The reduction of viscosity of the base polycarbonate implies that the processing temperature of polymer can be practically reduced.

6.2 Recommendation for further studies

1. Another pairs between engineering polymer and low molar mass liquid crystals chemical should be chosen for studying. The better pairs of blending may be found.
2. It should be interesting to study the phase diagram of low molar mass liquid crystal chemical and the base polymer. The morphologies of their blends are also interesting to investigate.
3. Shear viscosities and complex viscosities of the runner from injection molding products show that CBC33 has slight effects to Polycarbonate products. But this result contradicts data from literature review [Chuenchaokit, A., 1998] that were determined by capillary rheometer. It should be interesting to further measure the viscosity by capillary rheometer.

4. This research can be extended to study the mechanism of low molar mass liquid crystal chemical that why they can reduce the viscosity of the blends.



สถาบันวิทยบริการ
จุฬาลงกรณ์มหาวิทยาลัย

References

- Bird, R. B., et al. Transport Phenomena 2nd ed. John Wiley & Son, 2002.
- Blizard, K. C. and Baird, D. C. The Morphology and Rheology of Polymer Blends Containing a Liquid Crystalline Copolyester. Polymer Engineering and Science 27 (1987): 653-662.
- Brostow, W., et al. Rheological properties and morphology of binary blends of a longitudinal polymer liquid crystal with engineering polymer. Polymer 37 (1996): 1561-1574.
- Bryson, J. A. Plastic Materials 7th ed. London : Butterworth Scientific, 1999.
- Buckley, A., Conciatori, A. B. and Calundann, C. W, U.S. Patent (1984):4,434,262.
- Chik, G. L., et al. Properties and Morphology of Injection Moulding Liquid Crystalline Polymer/Polycarbonate Blends, Materials Processing Technology 63(1997): 488-493.
- Chuenchaokit, A. Effect of thermotropic liquid crystal on properties of Polycarbonates. Master's Thesis, Department of Chemical Engineering, Graduate School, Chulalongkorn University, 1998.
- Crawford, R. J. Plastics Engineering BPCC Wheatons, 1987.
- Demus, D., et al. Hanbook of liquid crystals volume. 2A: low molecular weight liquid crystals Wiley- VCH, 1998.

Folkes, M. J., Hope, P. 5. Polymer Blends and Alloys. London: Chapman & Hall, 1993.

Heino M. T. and Seppala, J. V. Extruded Blends of a Thermotropic Liquid Crystalline Polymer with Polyethylene Terephthalate, Polypropylene, and Polyphenylene Sulfide. Journal of Applied Polymer Science. 44(1992):2185-2195.

Hsieh, T. T., et al. Rheology and miscibility of thermotropic liquid crystalline polymer blends, Journal of Non-Newtonian Fluid Mech. 86 (1999):15-35.

Kulichikhin, V. G., et al. Rheology Mechanical and adhesive properties of thermoplastic-LCP blends dilled by glass fiber. Polymer Engineering and Science 37 (1997) : 1314-1321.

La Mantis, F. P., Valenza, A., Paci, M. and Magagnini, P. L. Rheology – Morphology Relationship in Nylon6/Liquid-Crystalline Polymer Blends. Polymer Engineering and Science 30(1990): 7-12.

Lin, Y. C., Lee, H. W. and Winter, H. H. Miscibility and viscoelastic properties of blends of liquid-crystalline polymer and poly(ethylene terephthalate). Polymer 34 (1993): 4703-4709.

Macosko, C. W. Rheology: Principle. Measurements and Applications VCH, 1994.

Merck. Information of Licrystal 1996.

Meng, Y. Z. and Tjong, S. C. and Hay, A. S. Morphology, rheological and thermal properties of the melt blends of poly(phthalazinone ether ketone sulfone) with liquid crystalline copolyester. Polymer 39 (1998): 1845-1850.

Olabisi, O. Hanbook of Thermoplastics Marcel Dekker, 1997.

- Powanusorn S., Application of Low Molar Mass Thermotropic Liquid Crystals as an Additive for Polymers. Master's Thesis, Department of Chemical Engineering, Graduate School, Chulalongkorn University, 2000.
- Shenoy, A. V., Saini, D. R. Thermoplastic Melt Rheology and Processing Marcel Dekker, 1996.
- Siegman, A., Dagan, A. and Kenig, S. Polyblends containing a liquid crystalline polymer. Polymer 26 (1985): 1325-1330.
- Sperling, L. H. Introduction to Physical Polymer Science 3rd ed. New York : John Wiley & Son, 2001.
- Tanner, R. I. Engineering Rheology Oxford Science, 1998.
- Van Krevelen, D. W., et al. Properties of Polymers 3rd ed. Elsevier Science, 1997.
- Xie, X. L. Tjong, S. C. and Li, R. K. Y. Study on in situ reinforcing and toughening of a semiflexible thermotropic copolyesteramide in PBT/PA66 blends. Journal of Applied Polymer Science 77 (2000) : 1975-1988.

Appendix

A. Rheology equipment



Figure A-1 Parallel plate rheometer



Figure A-2 Melt Flow Index Test machine

B. Raw data of complex viscosity from parallel plate measurements

Table B-1 Complex viscosity of PC-2600 and its blends with CBC33 at various range of frequency.

f (Hz)	Complex viscosity of PC-2600 and its blends (Pa.s)					
	Pure PC-2600	PC-2600 + 0.1%CBC33	PC-2600 + 0.2%CBC33	PC-2600 + 0.4%CBC33	PC-2600 + 0.8%CBC33	PC-2600 + 1%CBC33
1	7833	5724	4485	3352	3701	3701
0.681	7600	5967	3952	3757	3835	3648
0.464	7320	5511	3598	3706	3358	3343
0.316	7403	5973	3365	3297	3124	2900
0.215	7472	5143	3433	3350	3042	2915
0.147	7646	5198	3405	3470	3012	2942
0.1	7531	5101	3569	3565	2975	2878
0.06813	7283	5050	3660	3067	2962	2757
0.04642	7324	5170	3746	2796	2892	2619
0.03162	7641	5428	3944	2973	2872	2753
0.02154	7417	5303	3603	3040	2891	2856
0.01468	7246	5629	3670	3188	2981	2818
0.01	7616	5450	3735	3204	3147	2824

สถาบันวิทยบริการ
จุฬาลงกรณ์มหาวิทยาลัย

Table B-2 Complex viscosity of PC-2600 and its blends with GMS at various range of frequency.

f (Hz)	Complex viscosity of PC-2600 and its blends (Pa.s)					
	Pure PC-2600	PC-2600 + 0.1%GMS	PC-2600 + 0.2%GMS	PC-2600 + 0.4%GMS	PC-2600 + 0.8%GMS	PC-2600 + 1%GMS
1	7833	6547	6348	5726	4754	4579
0.681	7600	6290	5706	5283	5272	4798
0.464	7320	6349	5305	4901	4930	4839
0.316	7403	6602	5556	5397	4939	4642
0.215	7472	6256	5727	5119	4931	4486
0.147	7646	5882	5887	4804	4825	4420
0.1	7531	5808	5429	5024	4772	4722
0.06813	7283	5750	4983	4731	4609	4500
0.04642	7324	5790	5141	4590	4644	4299
0.03162	7641	5914	5373	5027	4419	4240
0.02154	7417	5940	5719	4966	4677	4376
0.01468	7246	6066	5885	5172	5039	4526
0.01	7616	6179	6062	5182	5281	4612

สถาบันวิทยบริการ
จุฬาลงกรณ์มหาวิทยาลัย

Table B-3 Complex viscosity of PC-2405 and its blends with CBC33 at various range of frequency.

f (Hz)	Complex viscosity of PC-2405 and its blends (Pa.s)					
	Pure PC-2405	PC-2405 +0.1%CBC33	PC-2405 +0.2%CBC33	PC-2405 +0.4%CBC33	PC-2405 +0.8%CBC33	PC-2405 +1%CBC33
1	3827	3695	3164	2953	2704	2541
0.681	3829	3651	3112	2884	2525	2194
0.464	3868	3163	2895	2348	2333	2142
0.316	3776	2885	2678	2241	2128	2094
0.215	3634	2729	2421	2124	2042	1968
0.147	3490	2634	2303	1949	1940	1993
0.1	3359	2834	2241	2029	2024	1928
0.06813	3439	2878	2292	2015	2029	1950
0.04642	3486	2760	2344	2205	2063	1997
0.03162	3555	3041	2441	2221	2045	2061
0.02154	3682	3021	2563	2298	2195	2147
0.01468	3837	3070	2579	2379	2199	2162
0.01	3969	3182	2626	2411	2252	2150

Table B-4 Complex viscosity of PC-2405 and its blends with GMS at various range of frequency.

f (Hz)	Complex viscosity of PC-2405 and its blends (Pa.s)					
	Pure PC-2405	PC-2405 +0.1%GMS	PC-2405 +0.2%GMS	PC-2405 +0.4%GMS	PC-2405 +0.8%GMS	PC-2405 +1%GMS
1	3827	3829	3758	3390	3222	2933
0.681	3829	3738	3187	3190	2907	2709
0.464	3868	3504	3110	3033	2767	2686
0.316	3776	3232	2940	2859	2873	2620
0.215	3634	3093	2984	2776	2785	2423
0.147	3490	2843	2776	2628	2721	2528
0.1	3359	2674	2712	2682	2501	2311
0.06813	3439	2610	2638	2533	2435	2277
0.04642	3486	2718	2647	2540	2436	2462
0.03162	3555	3017	2683	2635	2526	2423
0.02154	3682	2947	2795	2602	2566	2558
0.01468	3837	3097	2827	2594	2631	2552
0.01	3969	3348	2970	2792	2690	2682

Table B-5 Complex viscosity of PC-2600 and its blends with CBC33 by using single screw extruder and twin screw extruder.

f [Hz]	Complex viscosity of PC-2600 and its blends (Pa.s)			
	single screw extruder		twin screw extruder	
	PC-2600 Pure	PC-2600+0.2%CBC33	PC-2600 Pure	PC-2600+0.2%CBC33
1	5785	3821	6363	3908
0.681	6031	3519	6206	3968
0.464	6123	3120	5745	3716
0.316	5675	2904	6211	3497
0.215	5358	2816	5528	3281
0.147	5173	2783	5970	3003
0.1	5030	2727	6405	2929
0.06813	4709	2738	5951	2885
0.04642	4778	2991	5545	3160
0.03162	5294	2974	5237	3373
0.02154	5106	3199	5323	3436
0.01468	5360	3307	5530	3644
0.01	5501	3350	5655	3973

สถาบันวิทยบริการ
จุฬาลงกรณ์มหาวิทยาลัย

Table B-6 Complex viscosity of PC-2405 and its blends with CBC33 by using single screw extruder and twin screw extruder.

f [Hz]	Complex viscosity of PC-2405 and its blends (Pa.s)			
	single screw extruder		twin screw extruder	
	PC-2405 Pure	PC-2405+0.2%CBC33	PC-2405 Pure	PC-2405+0.2%CBC33
1	4018	993.3	3586	1481
0.681	3622	956.2	3373	1501
0.464	3424	964.3	3156	1340
0.316	3170	1011	2813	1326
0.215	2991	1017	2613	1266
0.147	2877	1010	2543	1195
0.1	2670	984.1	2609	1229
0.06813	2661	974.1	2666	1277
0.04642	2639	1041	2740	1520
0.03162	2608	1154	2864	1669
0.02154	2749	1293	2917	1688
0.01468	2843	1395	3001	1894
0.01	2951	1486	3183	2019

Table B-7 Complex viscosity from injection molding products of PC-2600 and its blends with CBC33 by using single screw extruder and twin screw extruder.

f [Hz]	Complex viscosity of PC-2600 and its blends (Pa.s)				
	PC-2600 Pure	single screw extruder		twin screw extruder	
		PC-2600 Pure	PC-2600 +0.2%CBC33	PC-2600 Pure	PC-2600 +0.2%CBC33
1	6075	4144	3579	4738	4338
0.681	6477	4419	4407	4737	4351
0.464	5628	4632	4087	4497	4201
0.316	5934	4533	4144	4595	4085
0.215	5426	4678	4177	4604	4261
0.147	5747	4662	4271	4435	4037
0.1	6118	4502	4243	4335	4057
0.06813	5910	4235	4016	4144	4076
0.04642	5853	4632	4168	4019	4009
0.03162	5570	4836	4146	4442	4168
0.02154	5794	4774	4443	4416	4174
0.01468	5809	4965	4604	4450	4104
0.01	5825	4988	4840	4424	4134

สถาบันวิทยบริการ
จุฬาลงกรณ์มหาวิทยาลัย

Table B-8 Complex viscosity from injection molding products of PC-2405 and its blends with CBC33 by using single screw extruder and twin screw extruder.

f [Hz]	Complex viscosity of PC-2405 and its blends (Pa.s)				
	PC-2405 Pure	single screw extruder		twin screw extruder	
		PC-2405 Pure	PC-2405 +0.2%CBC33	PC-2405 Pure	PC-2405 +0.2%CBC33
1	3958	2693	2130	2553	2707
0.681	3632	2622	2016	2566	2453
0.464	2904	2477	1916	2399	2263
0.316	2766	2334	1837	2144	2031
0.215	2498	2289	1823	2042	1821
0.147	2716	2219	1792	1975	1685
0.1	2585	2218	1744	2122	1680
0.06813	2659	2223	1701	2090	1649
0.04642	2733	2224	1623	1885	1708
0.03162	2952	2166	1654	1896	1750
0.02154	2981	2335	1670	1883	1804
0.01468	3255	2304	1694	2120	1882
0.01	3245	2327	1751	2270	1906

สถาบันวิทยบริการ
จุฬาลงกรณ์มหาวิทยาลัย

C. Rheological Properties of Liquid Crystal

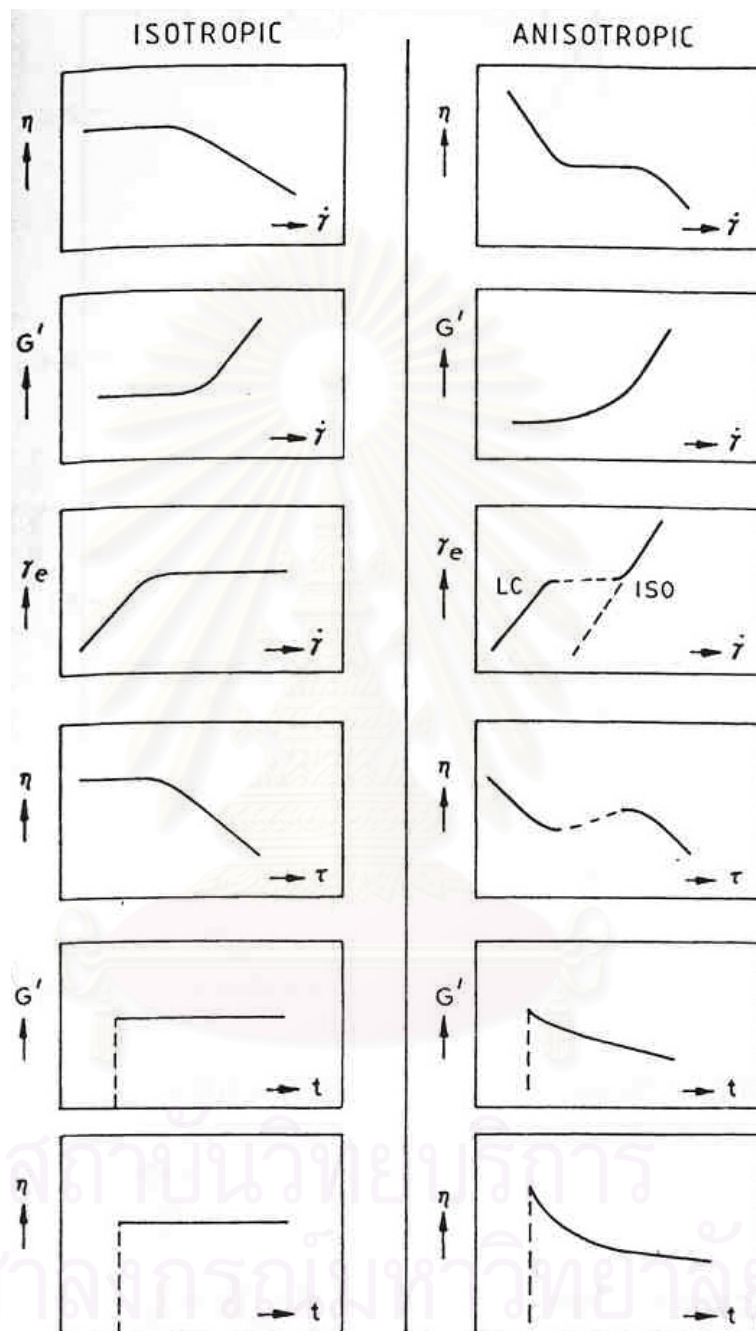

Figure C-1 Rheological behavior of isotropic versus anisotropic melt. All graphs are double logarithmic [Van Krevelen, D. W., et al., 1997].

Vita

Miss Noppawan Motong was born in Uttaradit, Thailand in September 17, 1979. She received the Bachelor Degree of Engineering in Plastics Engineering from the Material and Metallurgical Engineering, Rajamangala Institute of Technology in 1999. She entered the Master of Engineering in Chemical Engineering Program at Chulalongkorn University in 2000.



สถาบันวิทยบริการ
จุฬาลงกรณ์มหาวิทยาลัย