

การวัดระดับซีรูโลพลาสมีนในผู้ป่วยกลุ่มโรคความเคลื่อนไหวผิดปกติ



นาง เฮเลน หลิง

วิทยานิพนธ์นี้เป็นส่วนหนึ่งของการศึกษาคณะหลักสูตรปริญญาวิทยาศาสตรมหาบัณฑิต

สาขาวิชาอายุรศาสตร์ ภาควิชาอายุรศาสตร์

คณะแพทยศาสตร์ จุฬาลงกรณ์มหาวิทยาลัย

ปีการศึกษา 2551

ลิขสิทธิ์ของจุฬาลงกรณ์มหาวิทยาลัย

511583

MEASUREMENTS OF SERUM CERULOPLASMIN LEVEL IN PATIENTS WITH  
DIFFERENT MOVEMENT DISORDERS



Mrs. Helen Ling

A Thesis Submitted in Partial Fulfillment of the Requirements  
for the Degree of Master of Science Program in Medicine

Department of Medicine

Faculty of Medicine

Chulalongkorn University

Academic Year 2008

Copyright of Chulalongkorn University

Thesis Title                    MEASUREMENTS OF SERUM CERULOPLASMIN LEVEL IN  
PATIENTS WITH DIFFERENT MOVEMENT DISORDERS  
By                                 Mrs. Helen Ling  
Field of Study                 Medicine  
Thesis Advisor                Associate Professor Roongroj Bhidayasiri, M.D.  
Thesis Co-advisor            Professor Kammant Phanthumchinda, M.D.

---

Accepted by the Faculty of Medicine, Chulalongkorn University in Partial  
Fulfillment of the Requirements for the Master's Degree

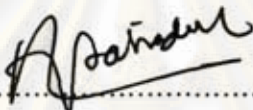
  
..... Dean of the Faculty of Medicine  
(Associate Professor Adisorn Patradul, M.D.)

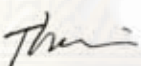

THESIS COMMITTEE

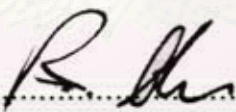
  
..... Chairman  
(Assistant Professor Thanin Asawavichienjinda, M.D.)

  
..... Thesis Advisor  
(Associate Professor Roongroj Bhidayasiri, M.D.)

  
..... Thesis Co-advisor  
(Professor Kammant Phanthumchinda, M.D.)

  
..... External Member  
(Major General Jithanorm Suwantamee, M.D.)

   
..... Member  
(Associate Professor Rungsun Rerknimitr, M.D.)

เสเลน หลิง : การวัดระดับซีรู โลพลาสมีนในผู้ป่วยกลุ่มโรคความเคลื่อนไหวผิดปกติ  
(MEASUREMENTS OF SERUM CERULOPLASMIN LEVEL IN  
PATIENTS WITH DIFFERENT MOVEMENT DISORDERS)

อ. ที่ปรึกษาวิทยานิพนธ์หลัก : รศ. นพ. รุ่งโรจน์ พิทยศิริ ,

อ. ที่ปรึกษาวิทยานิพนธ์ร่วม : ศ. นพ. กัมมันต์ ทันรุมจินดา ; 106 หน้า

**ที่มาของปัญหา :** การวัดระดับซีรู โลพลาสมีนเป็นวิธีที่ใช้บ่อยเมื่อสงสัยว่าผู้ป่วยที่มีความเคลื่อนไหวผิดปกติอาจเป็นโรควิลสัน แต่ข้อมูลจากการศึกษาพบว่า ซีรู โลพลาสมีนอาจมีผลต่อกระบวนการของการเสื่อมของเซลล์ประสาทในสมอง เช่นในโรคพาร์กินสัน เป็นต้น โดยไม่จำเพาะกับโรควิลสันเท่านั้น

**วัตถุประสงค์ :** เพื่อศึกษาระดับซีรู โลพลาสมีนในผู้ป่วยกลุ่มโรคความเคลื่อนไหวผิดปกติ และนำมาเปรียบเทียบกับผู้ที่มีสุขภาพแข็งแรง

**วิธีวิจัย :** ผู้ป่วยที่มาตรวจที่คลินิกกลุ่มโรคความเคลื่อนไหวผิดปกติ ระหว่างเดือนตุลาคม 2550-มกราคม 2551 ที่ผ่านเกณฑ์การคัดเลือกโดยมีอายุมากกว่า 18 ปี และได้รับการวินิจฉัยที่แน่นอน รวมทั้งอาสาสมัครที่มีสุขภาพแข็งแรง ได้รับการเจาะเลือดเพื่อตรวจหาระดับซีรู โลพลาสมีน และการตรวจอื่นๆ ทางห้องปฏิบัติการ ได้แก่ ระดับ ธาตุทองแดง และ สารแกมมา กลูตามิว ทรานส์เปปติเดส

**ผลการวิจัย :** ผู้ป่วยเข้าร่วมการวิจัยทั้งหมด 152 คน และมีอาสาสมัครที่มีสุขภาพแข็งแรง 95 คน พบว่าอายุเฉลี่ยของกลุ่มผู้ป่วยสูงกว่ากลุ่มควบคุม ในกลุ่มผู้ป่วยทั้งหมดพบว่า มีจำนวนผู้ป่วยโรคพาร์กินสันมากที่สุด ซึ่งพบถึง 55% ค่าเฉลี่ยของระดับซีรู โลพลาสมีนของกลุ่มผู้ป่วยโรคความเคลื่อนไหวผิดปกติต่ำกว่าของกลุ่มควบคุมอย่างมีนัยสำคัญทางสถิติ จากการวิเคราะห์ที่ศึกษากลุ่มย่อยพบว่า ผู้ป่วยโรคพาร์กินสัน และ โรคมือสั่นทางพันธุกรรม มีค่าซีรู โลพลาสมีนต่ำกว่ากลุ่มควบคุม และในผู้ป่วยโรคความเคลื่อนไหวผิดปกติที่เกิดจากภาวะการเสื่อมของเซลล์ประสาทมีค่าซีรู โลพลาสมีนต่ำกว่ากลุ่มควบคุมเช่นกัน ปัจจัยที่เกี่ยวข้องกับระดับซีรู โลพลาสมีนจากการวิเคราะห์ได้แก่ 1) กลุ่มโรคความเคลื่อนไหวผิดปกติ 2) เพศหญิง และ 3) สารแกมมา กลูตามิว ทรานส์เปปติเดส

**สรุป :** ผลการศึกษานี้ พบว่ากลุ่มผู้ป่วยที่มีการเคลื่อนไหวผิดปกติทั้งหมดที่ไม่ใช่โรควิลสัน มีค่าเฉลี่ยของระดับซีรู โลพลาสมีนต่ำกว่ากลุ่มควบคุม อย่างมีนัยสำคัญทางสถิติ การแยกวิเคราะห์กลุ่มย่อยพบว่าค่าซีรู โลพลาสมีนที่ต่ำพบได้ในเฉพาะบางกลุ่มโรคเท่านั้น ดังนั้นการวัดระดับซีรู โลพลาสมีนในผู้ป่วยที่มีการเคลื่อนไหวผิดปกติอาจสามารถนำมาช่วยในการวินิจฉัยแยกโรคในทางเวชปฏิบัติ

ภาควิชา อายุรศาสตร์

สาขาวิชา อายุรศาสตร์

ปีการศึกษา 2550

ลายมือชื่อนิสิต 

ลายมือชื่ออาจารย์ที่ปรึกษาวิทยานิพนธ์หลัก 

ลายมือชื่ออาจารย์ที่ปรึกษาวิทยานิพนธ์ร่วม 

# # 5074855930: MASTER OF MEDICAL SCIENCE PROGRAM

KEYWORD: CERULOPLASMIN / COPPER / IRON / MOVEMENT DISORDERS

HELEN LING: MEASUREMENTS OF SERUM CERULOPLASMIN LEVEL  
IN PATIENTS WITH DIFFERENT MOVEMENT DISORDERS.

THESIS PRINCIPAL ADVISOR: ASSOC. PROF. ROONGROJ BHIDAYASIRI

THESIS CO-ADVISOR: PROF. KAMMANT PHANTHUMCHINDA, 106 pp.

**Background:** Serum ceruloplasmin level is frequently measured in patients with abnormal movements when suspecting Wilson's disease. Recent evidence suggests the role of ceruloplasmin in the cascades of neuronal damage in Parkinson's disease and other neurodegenerative disorders.

**Objectives:** To compare the serum ceruloplasmin levels between patients with non-Wilsonian movement disorders and healthy controls.

**Methods:** The authors obtained serum samples from patients attending Chulalongkorn Movement Disorders Clinic between October 2007 and January 2008 and from healthy blood donors at the Thai Red Cross Blood Bank. The authors studied the serum levels of ceruloplasmin, copper and  $\gamma$ -glutamyl transpeptidase (GGT).

**Results:** Among 152 patients and 95 controls, mean age in patient group was higher than controls ( $58.9 \pm 14$  vs.  $38.2 \pm 10.4$ ;  $p < 0.001$ ). Disease entities included: Parkinson's disease (55%), essential tremor (11%), idiopathic focal dystonia (8.4%), parkinsonism-plus syndromes (8.4%), tardive syndromes (7.1%) and others. The mean ceruloplasmin level in patient group was significantly lower than controls ( $20.8 \pm 4.3$  mg/dl vs.  $23.3 \pm 6.2$  mg/dl;  $p < 0.001$ ). In subgroup analysis, ceruloplasmin levels in Parkinson's disease and essential tremor were lower than controls ( $p < 0.001$ ). Analysis according to etiologies of movement disorders showed reduced mean ceruloplasmin level in neurodegenerative disorders, but not in other etiologies, compared with controls ( $p < 0.001$ ). Linear regression indicated that female gender and GGT were factors that positively correlate with ceruloplasmin level; but not other factors i.e. age, disease duration.

**Conclusions:** From our cohort, reduced serum ceruloplasmin level in non-Wilsonian movement disorders further supports a pathological role of ceruloplasmin in various movement disorders not limited to WD. Interestingly, ceruloplasmin levels in subgroups of Parkinson's disease, essential tremor and neurodegenerative disorders were lower than controls. Such differential reduction of ceruloplasmin levels might be implemented as part of the diagnostic work-up in clinical practice.

Department: Medicine  
Field of Study: Medicine  
Academic Year: 2008

Student's Signature: Helen Ling  
Principal Advisor's Signature: R. Bhidayasiri  
Co-Advisor's Signature: K. Phanthumchinda

## ACKNOWLEDGEMENTS

I would like to thank the Thailand Research Fund for the research grant year 2008. I would like to thank our patients and blood donors who provided their serum samples for this study. I would like to extend my gratitude to Chulalongkorn Comprehensive Movement Disorders Center for providing partial financial support for this research project and for the generous help from the staff at the center. They included Mrs. Ratanarudee Devahafti, Miss Nuttuwadee Torsanit, Miss Chintana Dongarmont and Miss Lalita Kaewwilai.

I am very thankful for the kind and helpful assistance provided by the Thai Red Cross Blood Bank. Thank you for allowing our team to recruit their blood donors to enter the research study.

I am grateful for the valuable advice on research methodology by Assistant Professor Thanin Asawavichienjinda.

I am very thankful for the kind assistance by the staff at various departments at the King Chulalongkorn Memorial Hospital. Thanks to Professor Daungjai Kasantikul at the Department of Psychiatry for referring patients to enter our study. Thanks to Associate Professor Viroj Wiwanitkit at the Department of Laboratory Medicine for providing advice and support on laboratory tests for the serum samples. Thanks to the staff at the Endocrinology Laboratory for taking part in this study and for providing technical support.

Thanks to the neurology residents at the King Chulalongkorn Memorial Hospital for referring patients to our Movement Disorders Clinic.

ศูนย์วิทยุทรัพยากร  
จุฬาลงกรณ์มหาวิทยาลัย

## CONTENTS

	Page:
<b>Abstract (English)</b> .....	iv
<b>Abstract (Thai)</b> .....	v
<b>Acknowledgements</b> .....	vi
<b>Contents</b> .....	vii
<b>List of Tables</b> .....	viii
<b>List of Figures</b> .....	ix
<b>List of Abbreviations</b> .....	x
<b>Chapter I: Introduction</b> .....	2
1.1 Background and Rationale.....	2
1.2 Research Questions.....	4
1.3 Objectives.....	5
1.4 Hypothesis.....	5
1.5 Study Population.....	5
1.6 Abbreviations.....	6
1.7 Expected Benefits and Application.....	7
<b>Chapter II: Literature Review</b> .....	9
2.1 Introduction to Movement Disorders..	9
2.2 The Role of Ceruloplasmin Underlying Neurodegeneration....	23
2.3 Measurement of Serum Ceruloplasmin Concentrations.....	51
<b>Chapter III: Research Methods</b> .....	56
3.1 Research Methodology.....	56
3.2 Sample Size Calculations.....	60
3.3 Operation Definitions.....	60
3.4 Observation and Measurements.....	61
3.5 Statistical Analysis.....	62
3.6 Ethical Considerations.....	62
<b>Chapter IV: Results</b> .....	64
4.1 Demographic Data.....	64
4.2 Analysis of Serum Ceruloplasmin Levels.....	66
4.3 Analysis of other Serum Measurements.....	69
4.4 Subgroup Analysis of Serum Ceruloplasmin Measurements	70
<b>Chapter V: Discussions</b> .....	74
5.1 Ceruloplasmin and Brain Iron Metabolism .....	74
5.2 Reduced Serum Ceruloplasmin Levels in Non-Wilsonian	
Movement Disorders.....	75
5.3 Possible Mechanisms of Decreased Serum Ceruloplasmin.....	76
5.4 Elimination of Confounding Factors.....	77
<b>Chapter VI: Conclusions</b> .....	80
6.1 Summary of Findings.....	80
6.2 Limitations and Future Research.....	80
6.3 Research Benefits and Applications.....	82
<b>References</b> .....	84
<b>Appendices</b> .....	93
<b>Biography</b> .....	106

## LIST OF TABLES

	Page:
Table 1: Categories of Different Types of Abnormal Movements.....	10
Table 2: Predominant or Frequently Associated Features in Different Movement Disorders.....	11
Table 3: Role of Iron and Heavy Metals in Neurodegenerative Diseases. Heavy Metal Interaction Mediates Protein Aggregation.....	14
Table 4: Laboratory Findings in Wilson's and Menkes' Diseases.....	21
Table 5: Demographic Data of Patient and Control Groups.....	65
Table 6: Serum Measurements in Both Patient and Control Groups.....	68
Table 7: Factors Identified by Linear Regression Analysis to Affect Serum Measurements of Ceruloplasmin.....	69



ศูนย์วิทยทรัพยากร  
จุฬาลงกรณ์มหาวิทยาลัย



## LIST OF FIGURES

	Page:
Figure 1: Basal Ganglia Circuits.....	16
Figure 2: The gene encoding human ceruloplasmin has been mapped on chromosome 3q23-q24.....	18
Figure 3: Three-Dimensional Configuration of Ceruloplasmin Molecule.....	20
Figure 4: Diagram to Illustrate Dysfunction of Copper Homeostasis in Both Wilson's and Menkes' Diseases.....	21
Figure 5: Diagram to Illustrate the Important Role of Ceruloplasmin in Iron Metabolism and the Neurodegenerative Cascade.....	23
Figure 6: Brain MRI Showing Copper and Iron Deposition in Patient with Wilson's Disease. The Appearance Mimics the "Face of a Giant Panda".....	25
Figure 7: Picture of Kayser-Fleischer Ring in a Young Patient with Neurological Manifestation of Wilson's Disease... ..	26
Figure 8: Brain MRI Showing Iron Deposition, Mimicking "Eyes of the Tiger", in a Patient with Pantothenate Kinase Associated Neurodegeneration (PKAN).....	35
Figure 9: SPECT DOPASCAN Beta-CIT Measures Dopamine Transporter. Asymmetrical Loss of Presynaptic Dopaminergic Neurons are Observed in Patient with Parkinson's Disease.....	41
Figure 10: Hyperechogenicity of the Substantia Nigra in Patient with Parkinson's Disease and Normal Control.....	41
Figure 11: Positive Immunohistochemistry Staining for Ceruloplasmin in Lewy Bodies.....	42
Figure 12: Novel Missense Variation of Ceruloplasmin Gene in Patient with Parkinson's Disease.....	42
Figure 13: Coronal Section of MSA Brain Showing Atrophy and Greyish Iron Depositions in Bilateral Putamen.....	44
Figure 14: Neuronal Loss of Caudate nucleus in Huntington Disease Brain.....	47
Figure 15: Flow Chart to Illustrate Study Design.....	59
Figure 16: Total Number of Subjects Included in Our Study.....	65
Figure 17: Diagnosis of Different Movement Disorders in Patient Group.....	66
Figure 18: Positive Correlation between Ferritin Levels and Age.....	70

Figure 19: Mean Ceruloplasmin Levels in Parkinson's Disease and Essential Tremor were Significantly Lower than Controls.....	71
Figure 20: Proportion of Patients with Ceruloplasmin Levels below the Lower Limit of Normal Laboratory Reference Range of 20mg/dl.....	72
Figure 21: Mean Ceruloplasmin Level in Neurodegenerative Movement Disorders was Significantly Lower than Controls.....	73
Figure 22: Proposed Mechanisms of the Involvements of Ceruloplasmin in Different Movement Disorders.....	79
Figure 23: Diagram to Illustrate Different Ranges of Ceruloplasmin Levels in Various Movement Disorders.....	83



ศูนย์วิทยทรัพยากร  
จุฬาลงกรณ์มหาวิทยาลัย

**LIST OF ABBREVIATIONS**

CBGD:	Corticobasal ganglionic degeneration
CNS:	Central nervous system
CI:	Confidence interval
Cp:	Ceruloplasmin
CSF:	Cerebrospinal fluid
DA:	Dopamine
DLB:	Dementia with Lewy body
ET:	Essential tremor
GABA:	Gamma-aminobutyric acid
GGT:	$\gamma$ -glutamyl transpeptidase
GPI:	Glycosylphosphatidylinositol
HD:	Huntington's Disease
MRI:	Magnetic resonance imaging
MSA:	Multiple system atrophy
NBIA:	Neurodegeneration with brain iron accumulation
OCP:	Oral contraceptive pills
PD:	Parkinson's disease
PKAN:	Pantothenate kinase associated neurodegeneration
PSP:	Progressive supranuclear palsy
RLS:	Restless leg syndrome
SOD:	Superoxide dismutase
SSPE:	Subacute Sclerosing Panencephalitis
TIBC:	Total iron binding capacity
WD:	Wilson's disease

ศูนย์วิทยุทรัพยากร  
จุฬาลงกรณ์มหาวิทยาลัย

## CHAPTER I

### INTRODUCTION

#### 1.1 Background and Rationale

Abnormal movements are encountered frequently in clinical neurology practice. The majority of the abnormal movements are caused by the dysfunction in the interactions within the basal ganglia structures, its circuits and other associated regions in the central and peripheral nervous system. Diseases with predominantly symptoms of abnormal movements are termed movement disorders. Movement disorders encompass a variety of disease entities of different etiologies, which can be neurodegenerative, hereditary, toxic, metabolic and etc. One of the most common movement disorders is Parkinson's disease (PD), which is caused by progressive neurodegenerative process, in which genetic and environmental factors contribute to the toxicity of vulnerable neurons.

Wilson's disease (WD) is an autosomal recessive hereditary disorder, in which there is mutation of the gene coding for P-type ATP-ase, causing marked reduction of hepatic copper incorporation during the synthesis of ceruloplasmin (Cp). As a result, there is accumulation of copper in different organs in the body, commonly in the brain, liver, eye and kidney. Copper deposition in WD can be found in selected brain structures such as the basal ganglia. Therefore, patients with WD commonly present with abnormal movements, such as tremor, parkinsonism and dystonia. During the synthesis of Cp, incorporation of copper takes place prior to the secretion of *holo*-Cp into plasma, representing the measurement of Cp in our day-to-day clinical practice.



ต้นฉบับไม่มีหน้านี้  
NO THIS PAGE IN ORIGINAL

ศูนย์วิทยทรัพยากร  
จุฬาลงกรณ์มหาวิทยาลัย

Impairment of copper incorporation results in secretion of an unstable moiety, apo-Cp, which is rapidly degraded in the plasma. Serum measurement of Cp is used as a screening test for WD, in which the level of *holo*-Cp is low. The first clinical signs and symptoms of WD generally develop in the 2<sup>nd</sup> – 3<sup>rd</sup> decades of life, but earlier or later manifestations have also been reported. The diagnosis of WD is made by the assessment of clinical features, often involving more than one system. If WD is suspected, examination for Kayser Fleischer (KF) ring, copper deposits within the cornea, is commenced. Further diagnostic confirmation includes testing for abnormal copper metabolism. Serum Cp concentration is characteristically reduced by more than 50% of the lower limit of normal reference range in symptomatic patients, although it can be normal in WD especially with WD hepatitis. 24-hour urinary copper excretion is markedly increased. Only if the above findings are equivocal does liver biopsy is required for measurements of tissue copper content. Clinicians should have high level of suspicions of WD in young patients presenting with abnormal movements. Screening for KF ring and the measurement of serum Cp concentrations are mandatory for these patients. Since specific treatment including copper chelating agents is available for WD, early diagnosis or even presymptomatic screening in patients with affected sibling is essential to reduce morbidity. Other conditions associated with dysfunction of copper and Cp homeostasis includes aceruloplasminemia and Menkes' disease, which also commonly present with abnormal movements. Serum Cp concentrations are also reduced in these entities.

Recent studies have shown that Cp is implicated in the cascade of neurodegenerative process in several disease entities including PD. A missense Cp gene mutation was found in a patient with PD<sup>1,2</sup>. Immunohistochemistry study also demonstrated the co-localization of Cp with Lewy bodies, the pathological hallmark

of PD<sup>1</sup>. Furthermore, a recent retrospective study reported the finding of reduced serum Cp concentrations in various non-Wilsonian neurodegenerative or non-neurodegenerative movement disorders<sup>3</sup>. Nevertheless, the precise role the Cp in many non-Wilsonian movement disorders remains unclear.

The aim of this research study was to measure the serum levels of Cp in patients with different non-Wilsonian movement disorders. The finding of this study would help to further understand the role of Cp in different movement disorders and the diagnostic significance of reduced serum Cp levels in clinical practice. If the serum Cp concentration is indeed different from healthy controls, clinicians might consider using serum Cp measurement more frequently in the investigation of patients with movement disorders, not limited to the screening for WD alone.

## 1.2 Research Questions

Primary Research Questions:

- a. What is the serum ceruloplasmin level in patients with non-Wilsonian movement disorders?
- b. Is the serum ceruloplasmin level significantly higher in patients with non-Wilsonian movement disorders when compared with healthy controls?

## 1.3 Objectives

The aims of this research study were: (1) to measure the serum Cp levels in Thai patients with different non-Wilsonian movement disorders; and (2) to compare the means serum Cp levels between these patients and healthy controls.

#### 1.4 Hypothesis

$H_0$ :

- The mean serum ceruloplasmin level in patients with non-Wilsonian movement disorders is not significantly different from that of healthy controls

$H_1$ :

- The mean serum ceruloplasmin level in patients with non-Wilsonian movement disorders is significantly higher than that of healthy controls

#### 1.5 Study Population

Our case population was Thai patients with non-Wilsonian movement disorders. Sample of this population was obtained from patients who attended the Chulalongkorn Comprehensive Movement Disorder Clinic at King Chulalongkorn Memorial Hospital. Patients were required to be adults and have predominantly abnormal movements as their main symptoms, for which a clinical diagnosis had been made. In patients with young onset movement disorders under age 45 years, regardless of the presence of family history, Wilson's disease (WD) had to be excluded by the ophthalmologic examination for Kaiser-Fleischer rings and there should be absence of clinical and laboratory findings that are suggestive of WD. Control subjects were healthy blood donors who attended the Thai Red Cross Blood Bank. Subjects in both study and control groups would be excluded if they had conditions that might have affected their serum Cp levels. These included inter-current infections, inflammation and malignancies, abnormal renal function, protein



losing enteropathy, known liver diseases or pregnancy. Healthy volunteers in the control group who have a history of neurodegenerative disease, serious medical conditions, family history of movement disorders were also excluded from the study.

### 1.6 Abbreviations

CBGD:	Corticobasal ganglionic degeneration
CNS:	Central nervous system
CI:	Confidence interval
Cp:	Ceruloplasmin
CSF:	Cerebrospinal fluid
DA:	Dopamine
DLB:	Dementia with Lewy body
ET:	Essential tremor
GABA:	Gamma-aminobutyric acid
GGT:	$\gamma$ -glutamyl transpeptidase
GPI:	Glycosylphosphatidylinositol
HD:	Huntington's Disease
MRI:	Magnetic resonance imaging
MSA:	Multiple system atrophy
NBIA:	Neurodegeneration with brain iron accumulation
OCP:	Oral contraceptive pills
PD:	Parkinson's disease
PKAN:	Pantothenate kinase associated neurodegeneration
PSP:	Progressive supranuclear palsy

RLS:	Restless leg syndrome
SOD:	Superoxide dismutase
SSPE:	Subacute Sclerosing Panencephalitis
TIBC:	Total iron binding capacity
WD:	Wilson's disease

### **1.7 Expected Benefits and Applications**

The diagnosis of sporadic movement disorders remains a clinical one. There are no biomarkers to confirm the diagnosis. Existing diagnostic methods such as functional imagings for PD are expensive and are only limited for research purposes in Thailand.

The laboratory test for serum Cp measurement is very cheap. However, its measurement is mostly limited to screening for Wilson's disease in current clinical practice. Limited existing data has suggested that Cp might be involved in the pathophysiology of other types of movement disorders such as PD. Mean Cp levels were also found to be reduced in other movement disorders in previous small retrospective studies as well as in our clinical practice.

Therefore, we aim to study the serum Cp levels in patients with non-Wilsonian movement disorders and to compare them with healthy controls. The results of this study will help determine the clinical importance of serum Cp measurement in the investigation of patients with abnormal movements. If Cp levels are found to be low in certain disease entities, it can also improve our understanding of the role of Cp and the diagnostic significance of serum Cp levels. The findings for this study can

potentially lead to change in clinical practice by introducing serum Cp measurement as a routine investigation for patients with various movement disorders.



ศูนย์วิทยทรัพยากร  
จุฬาลงกรณ์มหาวิทยาลัย

## CHAPTER 2

### LITERATURE REVIEW

#### 2.1 Introduction to movement disorders

##### *Categories of Different Types of Abnormal Movements:*

Movement disorders encompass a variety of disease entities characterized by the presence of excessive movements, *hyperkinetic disorders*, or poverty of motions, *hypokinetic disorders*. Examples of hyperkinetic disorders include chorea, hemiballismus, dystonia, tremor, tics, ataxia and myoclonus. Hypokinetic disorders feature slow, low-amplitude movement associated with rigidity and postural instability as seen in parkinsonism. Although the majority of hyperkinetic movements are involuntary, there are instances in which the precise nature of the movement is difficult to define. Among them, tics and akathisia are examples of hyperkinesias in which the patient is aware of an inner sensation that somehow acts in triggering the abnormal movement. It is not possible then to qualify these movements as totally involuntary (Table 1). Many movement disorders manifest a combination of hyper- and hypokinetic features as a result of the dysfunction of interactions within basal ganglion structures and between basal ganglia and other central nervous system areas.

Movement disorders also include a variety of other neurological disturbances featuring abnormalities of muscle tone and posture. Certain movement disorders may show a distinctive combination of disturbances of tone, posture, and movement. Such is the case in Parkinson's disease, which combines rigidity (increase in muscle tone),

tremor (hyperkinetic movement), and bradykinesia (hypokinetic movement) with a flexed or stooped posture and reduction in arm-swing while walking.

Table 1: Categories of Different Types of Abnormal Movements

<p><b>Hyperkinetic Abnormal Movements:</b></p> <ul style="list-style-type: none"> <li>- Chorea</li> <li>- Ballism</li> <li>- Tremor</li> <li>- Myoclonus</li> <li>- Tics</li> <li>- Dystonia</li> <li>- Others (stereotypies, akathisia, restless legs, moving toes/fingers)</li> </ul>
<p><b>Hypokinetic Abnormal Movements:</b></p> <ul style="list-style-type: none"> <li>- Bradykinesia (seen in parkinsonism including Parkinson's disease and other parkinsonian syndromes)</li> </ul>

*Diagnosis of Movement Disorders:*

Diagnosis of movement disorders relies heavily on clinical identification of the phenomenology of each type of abnormal movements present in a patient followed by recognition of associated features. A particular combination of signs is defined as a syndrome, irrespective of its etiology. In the case of movement disorders, there may be instances in which the presence of a single type of abnormal involuntary movement constitutes the whole syndrome e.g. postural and action tremor in essential tremor. On the other hand, there are examples of movement disorders in which

different types of abnormal movements coexist with abnormalities of tone and posture. For example, the presence of combination of tremor, rigidity, bradykinesia and postural instability in parkinsonism, or the presence of sustained dystonic spasms, dystonic jerks or tremor, myoclonus and abnormal twisting postures in dystonic syndromes. Table 2 gives examples of different clinical disorders in which a single type of abnormal movement is the predominant or frequently associated feature, in contrast to other movement disorders in which there may be more than one type of movement disorder present.

Table 2: Predominant or Frequently Associated Features in Different Movement Disorders

Features	Associated Movement Disorders
Predominant:	
- Dystonia	Idiopathic focal or generalized
- Chorea	Benign hereditary chorea Lupus chorea
- Tremor	Essential tremor
- Myoclonus	Essential myoclonus Postanoxi myoclonus Drug-induced myoclonus
- Tics	Gilles de lat Tourette's syndrome

Frequently associated :	
- Dystonia	Wilson's disease
- Chorea	Huntington's disease
- Tremor	Parkinson's disease
	Wilson's disease
- Myoclonus	Multiple system atrophy
- Tics	Neuroacanthocytosis

The final step in the process of diagnosis of movement disorders is disease recognition. Disease identification involves not only the characterization of the presence of different abnormal movements, but also taking into consideration of age of onset of symptoms, the temporal course of the disease, response to medications, the past medical history or drug history of the patient, the presence or absence of family history, the presence of associated signs and symptoms suggesting the involvement of other areas of the nervous system, and in some cases, the findings of abnormalities in laboratory and imaging studies. Etiologies of movement disorders range from idiopathic, neurodegenerative, toxic, metabolic, hereditary, iatrogenic, drug-induced, traumatic, psychogenic and etc.

#### *Neurodegenerative Movement Disorders:*

Some movement disorders such as Parkinson's disease (PD) are caused by progressive neurodegenerative process, in which genetic and environmental factors contribute to the toxicity of vulnerable neurons (Table 3). PD is one of the most commonly encountered movement disorders in clinical practice. PD is the second most common neurodegenerative disorder and the prevalence in individuals above 65

years of either sex is approximately 100 per 100,000 populations<sup>4</sup>. Although its incidence is higher in the fifth and sixth decades, it is not unusual to encounter patients with onset of the disease below age 40, which is also known as young-onset PD. As in some other movement disorders, there are no biological markers that allow for its diagnosis antemortem. Recently, functional neuroimaging can aid in the differential diagnosis in doubtful cases with good specificity and sensitivity<sup>5</sup>, however, its availability is still limited to research purpose in Thailand. At present, the diagnosis of PD is based on clinical criteria and its definite confirmation is only possible through postmortem analysis or pathologic findings. Pathologically proven PD requires the presence of neuronal loss in the substantia nigra and cytoplasmic inclusions called Lewy bodies. Even after applying clinical criteria, there will remain a number of cases in which the diagnosis is proved wrong at autopsy by up to 10 percent<sup>6</sup>. The recent discovery of genetic foci, such as  $\alpha$ -synuclein gene mutation in the small percentage of PD caused by monogenetic mutation<sup>7</sup>, has enhanced our understanding of the pathogenesis and the role of toxic proteins in PD and other neurodegenerative disorders. Nevertheless, to date, the identification of environmental risk factors as well as the actual mechanisms of neuronal toxicity remains unclear.

Other neurodegenerative movement disorders include progressive supranuclear palsy (PSP), multiple system atrophy (MSA), corticobasal ganglionic degeneration (CBGD), dementia with Lewy body (DLB) and Huntington's disease (HD). These entities manifest with combinations of abnormal movements in association with other neurological disturbances. As in PD, confirmation of diagnosis requires pathological examination at autopsy, in which pathological hallmarks in susceptible regions of the brain are identified.



**Table 3: Role of Iron and Heavy Metals in Neurodegenerative Diseases. Heavy Metal Interaction Mediates Protein Aggregation.**

Specific Protein	Metals	Tissue	Diseases
A-Beta	Cu, Fe, Zn	Neocortex	Alzheimer's Disease
Prion Protein, PrPc	Cu	Neocortex	Creutzfeldt-Jacob Disease
Superoxide Dismutase 1, SOD1	Cu	Motor Neurons	Familial Amyotrophic lateral sclerosis
Alpha-Synuclein	Cu, Fe	Basal Ganglia	Parkinson's Disease

### 1.7.1 Basal Ganglia Anatomy and Pathophysiology

Parkinsonism, chorea, ballism, and dystonia are examples of movement disorders in which the basal ganglia are consistently affected in a specific fashion.

The basal ganglia circuit can be affected functionally or anatomically as a result of different mechanisms in various movement disorders<sup>8</sup>.

The main afferents to the basal ganglia lead from the cerebral cortex to the striatum. Within the striatum, particularly the putamen, there are two parallel outflow

channels: the direct pathway and the indirect pathway. The direct pathway leads from the putamen to the internal segment of the globus pallidus. The indirect pathway leads from the putamen to the external segment of the globus pallidus, then to the subthalamic nucleus, and from there to the internal segment of the globus pallidus. Each of these two striatopallidal pathways has gamma-aminobutyric acid (GABA) as the primary neurotransmitter. Dopamine (DA), the main neurotransmitter involved in the pathogenesis of PD, has a differential effect on the GABAergic neurons in the two pathways, through stimulation of DA receptors located on these neurons. A reduction of DA in the substantia nigra decreases GABA mediation of neuronal activity in the direct pathway, but increases GABA mediation in the indirect pathway.

In PD, the decrease of GABA results in disinhibition of activity in the internal segment of the globus pallidus in the direct pathway, which, in turn, inhibits output from the thalamus to the cerebral cortex. An increase in GABA, on the other hand, inhibits activity in neurons in the external segment of globus pallidus in the indirect pathway, which leads to disinhibition of activity in the subthalamic nucleus. This stimulates neurons in the internal segment of the globus pallidus, which further reduces output from the thalamus to the cortex. With thalamic activity suppressed by the resulting effects of DA denervation in both direct and indirect pathways, the overall thalamic output to the cortex is severely reduced, leading to the varied motor responses that are symptomatic of parkinsonism, mainly bradykinesia and rigidity.

Chorea, on the other hand, is the result of loss of striatal GABAergic neurons projecting to the globus pallidus. Neurons primarily affected in chorea are GABAergic neurons that give rise to the indirect pathway. Reduced inhibition of the external pallidum releases its inhibitory projection to the subthalamic nucleus, thus reducing excitatory impulses acting on the internal segment of the globus pallidus.

The presence of impaired inhibition in the pallidothalamic outflow releases the thalamocortical pathway with increased excitatory output to the motor cortex, leading to hyperkinetic choreiform movements (Figure 1).

A thorough understanding of the anatomy, physiology, biochemistry and pathophysiology of the basal ganglia has led to the development of novel and refined techniques in the functional surgery of movement disorders.

Figure 1: Basal Ganglia Circuits<sup>8</sup>

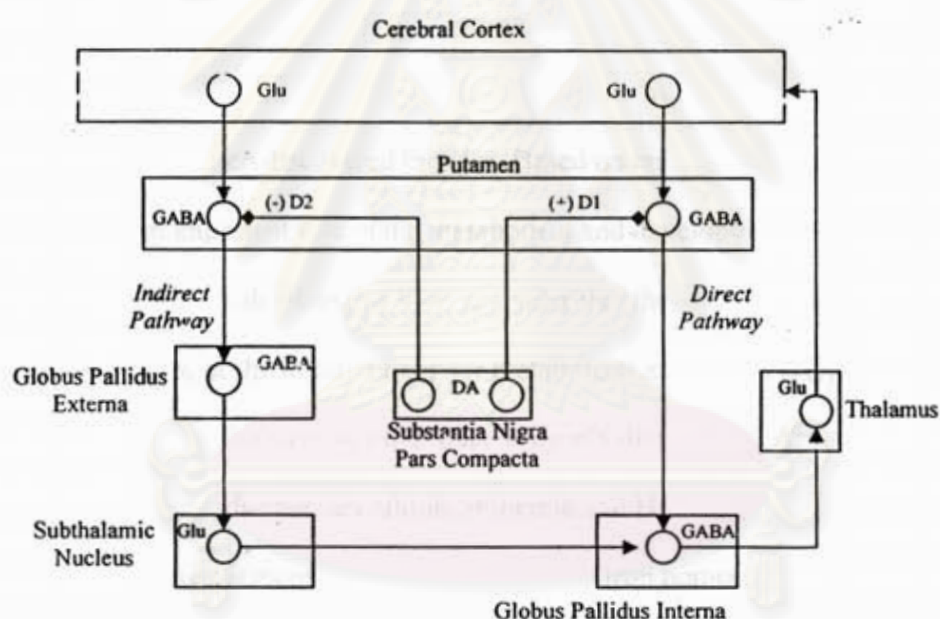

## 2.1 Overview of Ceruloplasmin

### *The Discovery of Ceruloplasmin:*

Cp is a protein of the  $\alpha_2$ -globulin fraction of human blood serum. It contains 95% of serum copper. Cp was first described by Holmberg<sup>9</sup> in 1944 and was characterized by Hoimberg and Laurell<sup>10</sup> four years later. In 1952, the relation of Cp

to hereditary degenerative processes in humans was documented by Scheinberg and Gitlin<sup>11</sup>, who discovered a decrease of its concentration in the serum of patients with hepatolenticular degeneration also known as Wilson's disease. It is now known that it is not Cp concentration, but its enzymatic activity which drops as the protein is synthesized in liver predominantly in the apo form. Both the presence of copper-free Cp in serum and neurological symptoms are secondary to hereditary alteration of copper metabolism in hepatocytes.

In the 1970s indirect indications concerning possible involvement of Cp in oxidation of epinephrine and serotonin in the central nervous system were obtained<sup>12</sup>.<sup>13</sup>. The protein was detected in the brain and later the details of its synthesis in glial cells were discovered<sup>14-16</sup>. It is possible that the functions of Cp in the brain exist beyond what have been discovered thus far. Based on our present knowledge, this protein plays an important role in the metabolism and development of nervous tissue. This assumption is made plausible if we consider that the deficiency of Cp, its impaired function, or the failure of copper metabolism as a whole is typical of several other neurodegenerative disease other than Wilson's disease, e.g. Alzheimer's disease, Parkinson's disease, aceruloplasminemia and Huntington's disease<sup>17-20</sup>. Since one of the main functions of Cp is the regulation of iron homeostasis, impaired function of Cp can cause toxic iron accumulation in the neurons leading to neuronal toxicity in the aforementioned disease entities.

#### *Ceruloplasmin gene and its expression:*

The gene encoding human Cp has been mapped on chromosome 3q23-q24<sup>21</sup>. It contains 20 exons with total length about 65 kb (Figure 2). Hepatocytes synthesize Cp which is subsequently found in plasma. Serum measurement of Cp, *holo-Cp*, is

provided by the liver, but extrahepatic gene expression for this protein has been documented. Organs that express Cp gene are the brain, lung, spleen and testis. In the central nervous system of humans and other mammals, Cp is expressed in astroglial cells, e.g. of the cerebral microvascular network, and in the neurons. In astrocytes, leptomeningeal cells and Sertoli cells, Cp is membrane anchored by glycosylphosphatidylinositol (GPI), which is caused by alternative splicing of exons 19 and 20 in Cp gene. As a result, the latest 5 C-terminal amino acids found in serum Cp are replaced by a 30-amino acid stretch in GPI-Cp. The function of this Cp isoform is now thought to play an important role in iron oxidation and mobilization in the brain. Jeong and David<sup>22</sup> demonstrated that GPI-Cp and iron exporter protein IREG1 act together to provide iron efflux from astrocytes. Both proteins are localized at the astrocyte surface. Gene transcription of an acute phase reactant Cp is mediated by inflammatory cytokines and is increased in hepatocytes secondary to inflammation, trauma, infection, etc.

Figure 2: The gene encoding human ceruloplasmin has been mapped on chromosome 3q23-q24

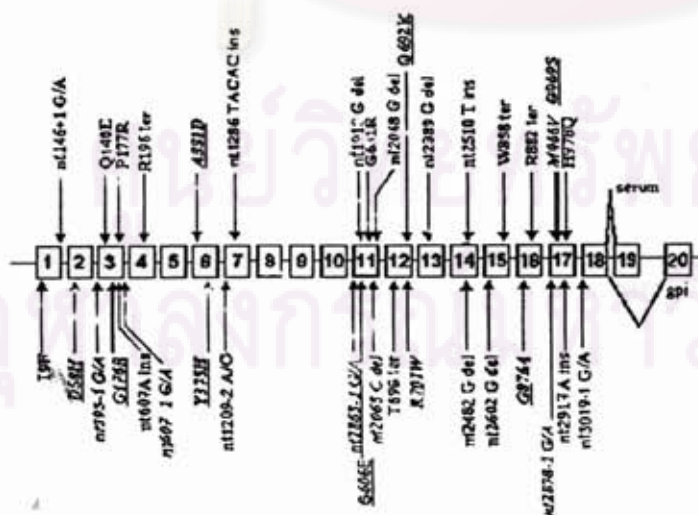

### *Structure and Function of Ceruloplasmin:*

Cp molecule is a single chain of 1046 amino acids (Figure 3). It consists of six structural domains. Copper ions are generally specified as three types, depending on their spectroscopic properties. All three types of copper ions are found in Cp<sup>23</sup>. Since every type of copper has its unique ligand binding, their redox potentials vary considerably. It is because of the particular combination of copper ions with different properties that Cp can accomplish its oxidase reaction with four electrons transferred from substrate to oxygen within one cycle. The spatial structure of human Cp contains the three-copper molecules in the center, which is called "trinuclear cluster" formed by the closely co-located type III copper and type II copper<sup>24</sup>. This cluster plays a crucial role in the oxidase reaction as two electrons at a time are loaded here to O<sub>2</sub> producing ½ H<sub>2</sub>O, instead of the toxic free radical, H<sub>2</sub>O<sub>2</sub>.

Ceruloplasmin (Cp) is a copper transport protein and a major plasma anti-oxidant. It is synthesized in several tissues including liver and brain<sup>25</sup>. A specific form of Cp, glycosylphosphatidylinositol (GPI), is expressed on astrocytes in the central nervous system (CNS) as well as in the retina and the epithelial cells of the choroid plexus<sup>15</sup>. The detailed studies by Frieden's group proved the ability of Cp to oxidize the toxic Fe<sup>2+</sup> to the non-toxic Fe<sup>3+</sup><sup>26</sup>. Therefore, Cp is often termed "ferroxidase". Thus, Cp plays a major role in iron homeostasis in the CNS by preventing oxidative damage to the neurons<sup>16</sup>.

Cp is also an acute phase reactant, its concentration increases in inflammation, trauma, etc, which is mostly attributed to its properties as an antioxidant.

During the synthesis of Cp, incorporation of copper takes place prior to the secretion of *holo*-ceruloplasmin into plasma, representing the measurement of Cp in our day-to-day clinical practice. Impairment of copper incorporation results in

secretion of an unstable moiety, *apo*-ceruloplasmin, which is rapidly degraded in the plasma and lacks ferroxidase activity. Therefore, abnormal Cp synthesis or its dysfunction can lead to impairment of iron metabolism, subsequent Fe<sup>2+</sup> iron overload (Fe<sup>2+</sup>), production of free radicals and ultimately neuronal death<sup>16</sup>. The dysfunction of Cp can be found in monogenetically inherited disorders such as Wilson's disease, Menkes' disease and aceruloplasminemia (Figure 4 and Table 4). Recently, Cp has been implicated in the pathogenesis of several sporadic neurodegenerative diseases including Alzheimer's disease and Parkinson's disease<sup>1,2,27</sup>. It is still uncertain whether the role of Cp in the cascade of neuronal death is primary or secondary.

Figure 3: Three-Dimensional Configuration of Ceruloplasmin Molecule



Figure 4: Diagram to Illustrate Dysfunction of Copper Homeostasis in Both Wilson's and Menkes' Diseases

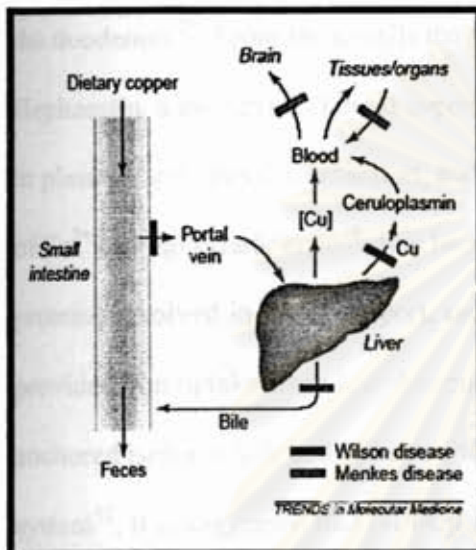

Table 4: Laboratory Findings in Wilson's and Menkes' Diseases

Tests	Menkes' Disease	Wilson's Disease
Inheritance	X-linked	Autosomal Recessive
Copper Distribution:		
Cp (20-30mg/dl)	< 20	< 20
Serum Copper (70-152µg/dl)	< 70	19-64
Urine copper (<40 µg/dl)	< 40	100-1000
Liver copper (20-50 µg/g dry wt)	< 50	>250



### *Role of Ceruloplasmin in Iron Metabolism*

As discussed above, Cp is a copper-containing protein with an essential role in the regulation of iron metabolism. In human, iron is absorbed by the epithelial cells of the duodenum<sup>28</sup>. From these cells the metal is released into blood circulation.

Hephaestin, a membrane-bound copper protein highly homologous to Cp circulating in plasma facilitates this transport, and it oxidized  $Fe^{2+}$  to  $Fe^{3+}$  to ensure incorporation of  $Fe^{3+}$  into *apo*-transferrin<sup>28</sup>. It is likely that hephaestin cooperates with other proteins involved in iron transport, such as IREG1<sup>29</sup>. The oxidation of  $Fe^{2+}$  to  $Fe^{3+}$  provides iron uptake from blood circulation by cells of various organs<sup>30</sup>. Its GPI-anchored isoform is found in astrocytes and Schwann cells of the central nervous system<sup>15</sup>. It is suggested that GPI-Cp in astrocytes loads *apo*-transferrin with ferric iron<sup>15</sup>. Loading iron to transferrin is preceded by its oxidation by Cp and the entire process reduces the concentration of the neurotoxic  $Fe^{2+}$  to a minimum level. This important role of Cp in iron metabolism was strengthened by the recent finding of a rare genetic disorder, aceruloplasminemia, which is caused by a mutation entailing premature termination of Cp-mRNA translation (Figure 5).

ศูนย์วิทยทรัพยากร  
จุฬาลงกรณ์มหาวิทยาลัย

Figure 5: Diagram to Illustrate the Important Role of Ceruloplasmin in Iron Metabolism and the Neurodegenerative Cascade

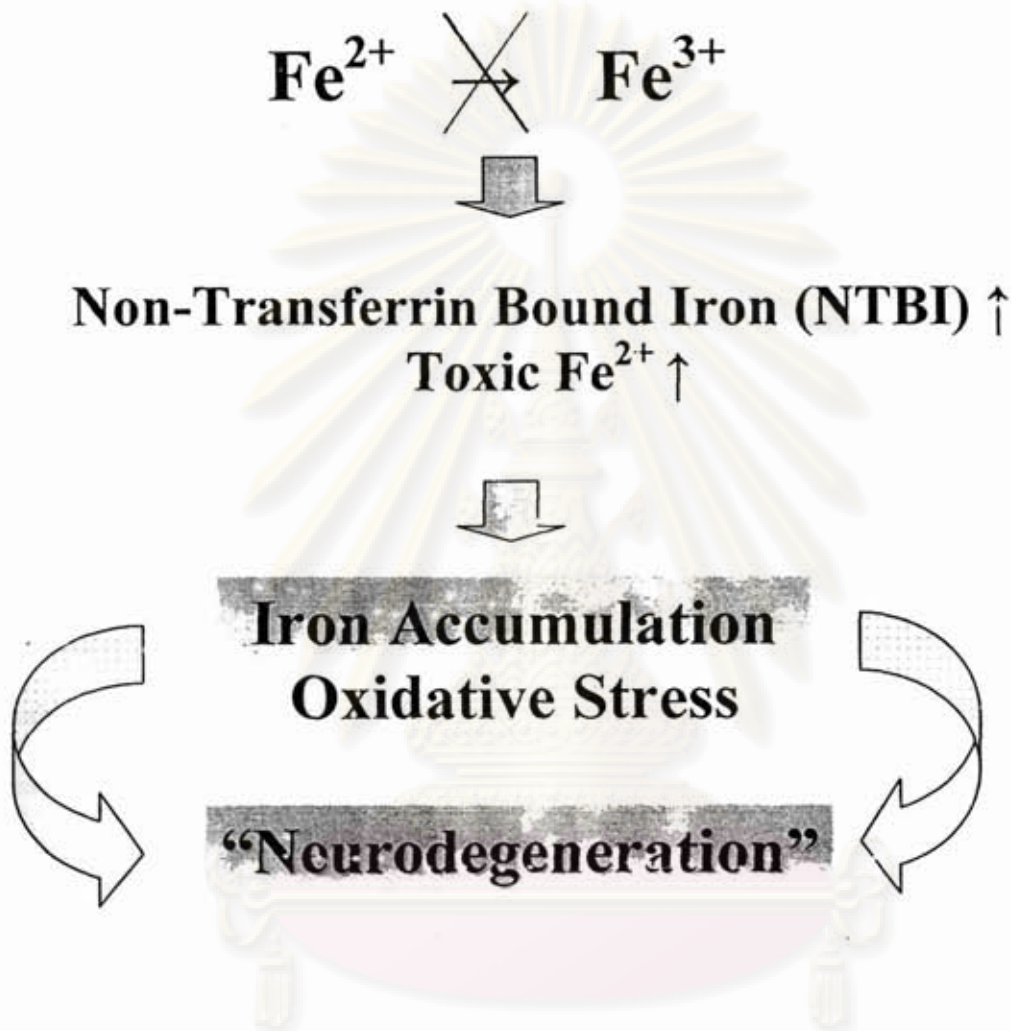

## 2.2 The Likely Role of Ceruloplasmin Underlying Neurodegeneration

### *The Ceruloplasmin-Regulated Oxidation of Non-Iron Substrates in the Brain*

Blood plasma has a pH of about 7.4, and it contains a large amount of chloride. New data showed that chloride can enhance the oxidase activity of Cp by 100-fold at neutral pH and thus, it might play an important role in the oxidation of a few crucial substances besides iron molecules in both plasma and intracellular

milieu<sup>31</sup>. One of these substances is 6-hydroxydopamine<sup>32</sup>. This catecholamine is an intermediate produce on the way to the formation of dopamine-melanin. Spontaneous oxidation of 6-hydroxydopamine results in H<sub>2</sub>O<sub>2</sub> production, which is not observed when Cp is involved in the catalysis<sup>32,33</sup>. It seems likely that Cp might be the enzyme that controls or participates in controlling catecholamine oxidation in the brain and that its deficiency in cerebral structures, e.g. in striatum, substantia nigra, globus pallidum, underlies Parkinson's disease and perhaps other neurodegenerative syndromes<sup>34</sup>.

#### *Altered Copper Metabolism and Ceruloplasmin*

Copper is absorbed from the small intestine and is transported to the liver where it is normally stored. A specific transporter of copper ions to hepatocytes, human copper-transporting protein, hCtr1, has been identified<sup>35,36</sup>. Together with other so-called "copper chaperones", they transport copper molecules within the cells in the liver. In the cell, copper ions can follow one of the four pathways<sup>37,38</sup>. They can be:

- (a) stored bound by copper-thionein
- (b) carried to Cu,Zn-superoxide dismutase (SOD)
- (c) delivered to mitochondria, or
- (d) conveyed by the chaperone HAH1 to the Wilson's disease P-type ATP-ase.

The P-type ATP-ase enzyme is located in the *trans*-Golgi network and functions to provide copper incorporation into Cp<sup>37</sup>. However, the synthesis of Cp does not depend on the availability of copper. Under conditions of copper deficiency or in the absence of P-type ATP-ase, a protein required for the synthesis of *holo*-Cp, the presence of formation of *apo*-Cp in the plasma is observed.

### *Wilson's Disease*

Wilson's disease (WD) is the prototypic example of copper-free Cp synthesis. WD is caused by a hereditary mutation in the gene coding for WD ATP-ase, which greatly reduced the delivery of copper to Cp<sup>39</sup>. As a result, copper molecules reside in hepatocytes, redox cycling between Cu<sup>1+</sup> and Cu<sup>2+</sup> catalyses the production of hydroxyl radicals that damage DNA, proteins, lipids, etc, intoxicating the cells and ultimately, provoking cirrhosis<sup>40</sup>. Simultaneously copper is accumulated in selected brain structures, such as nucleus lenticularis, substantia nigra, globus pallidum, corpus striatum<sup>41,42</sup> (Figure 6), and in the cornea where its deposits form typical Kayser-Fleischer rings<sup>43</sup> (Figure 7). Accumulation of copper in brain structures, which can be identified by hyperintensity signals on T2 weighted images in magnetic resonance imaging (MRI), is believed to cause the symptoms of neurological degeneration.

Figure 6: Brain MRI Showing Copper and Iron Deposition in Patient with Wilson's Disease. The Appearance Mimics the "Face of a Giant Panda"



Figure 7: Picture of Kayser-Fleischer Ring in a Young Patient with Neurological Manifestation of Wilson's Disease

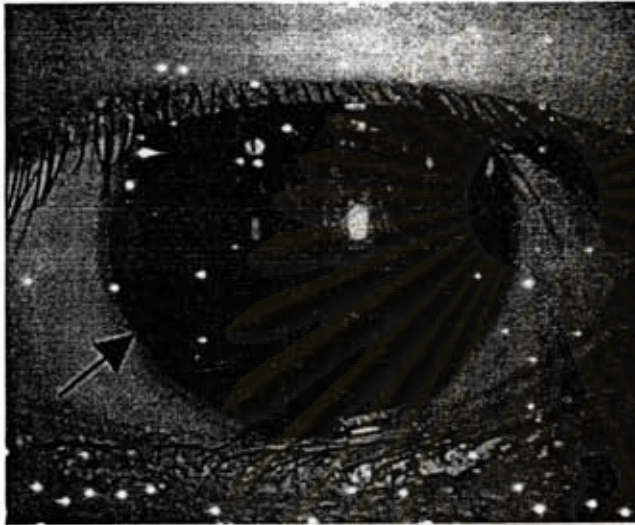

Neurological presentations of WD can be extremely subtle, intermittent, or hard to categorize<sup>42</sup>. Most typically, these involve action tremor or dystonia (especially affecting cranial musculature). Sometimes, typical parkinsonian features are initial presentations. Cerebellar outflow tremor, ataxic speech, and other signs characteristics of white matter disease can also develop. The tremor in WD can be symmetrical or unilateral, and sometimes is paroxysmal. A characteristic form is a coarse, irregular proximal tremulousness with a “wing beating” appearance. Tremor in WD is unresponsive to ethanol or medications used for treating the tremor in Parkinson's disease or essential tremor. It can coexist with generalized ataxia<sup>40</sup>.

Commonly, motor impairment in WD also involves the cranial region.

Clinical manifestations include problems such as dysarthria, drooling, cranial and oropharyngeal dystonia<sup>40</sup>. Wilson described a characteristic facial grimacing with jaw opening and lip retraction<sup>44</sup>. Blepharospasm, tongue dyskinesia, progressive speech disturbance and drooling frequently occur as WD progresses<sup>45</sup>.

WD can also present with a wide spectrum of behavioral or psychiatric disorders<sup>45</sup>. Sometimes these are the earliest features, preceding motor impairments. The psychiatric features can involve relatively common problems in the general population like depression, other mood alterations, or anxiety. In childhood WD, the psychiatric manifestations may include declining school performance, personality changes, impulsiveness and behavioral regression. Memory impairment and other aspects of cognitive decline can also develop. Patients have been described with initial presentations of psychotic features resembling paranoia and schizophrenia. Less common psychiatric presentations have included aggressiveness, suicidal ideation, self-injury, and hypersexuality<sup>40</sup>. In rare instances, WD can manifest as either focal or generalized seizures.

Characteristic ophthalmic involvement in WD produces Kayser-Fleischer rings, composed of copper – containing granules within Descemet's membrane of the cornea<sup>43</sup>. KF rings are usually bilateral and arise around the corneal periphery, especially at its upper pole. Virtually all WD with neurological involvement shows KF rings. Generally identified without magnification, KF rings require a careful slit lamp examination for definitive diagnosis (and many ophthalmologists are unfamiliar with this finding). Also typical of copper deposition is a "sunflower" cataract. WD can show disturbances of smooth pursuit, convergence, and fixation as well as eyelid opening apraxia.

WD is an autosomal recessive disorder, localized on chromosome 13q14.3<sup>46</sup>. The gene, *ATP7B*, encodes a copper-transporting P-type ATP-ase. Mutation within the *ATP7B* gene in WD leads to ineffective packaging of copper and ineffective biliary excretion. Thus, the net result is progressive copper accumulation in the hepatocytes and, eventually, extra-hepatic tissues. Over 300 *ATP7B* mutations have

been identified<sup>47</sup>. Only homozygotes who inherit disease-specific mutations of both alleles of the *ATP7B* gene develop WD. Heterozygote carriers of the mutations are spared any clinical features, although they may manifest a reduced serum Cp. Age of onset, site of organ involvement, and other disease characteristics could conceivably have their origins in different *ATP7B* mutations. In general, there is no definite association between *ATP7B* genotype and WD presentation or its subsequent clinical course<sup>48</sup>.

Neurological WD should be suspected with unexplained extrapyramidal or cerebellar impairments, or psychiatric, cognitive, and behavioral disorders. Asymptomatic siblings need to be tested. Although the first clinical signs and symptoms generally develop in the 2<sup>nd</sup>-3<sup>rd</sup> decades of life, earlier and later WD manifestations have also been reported<sup>45</sup>. Familial WD helps guide diagnostics with known affected siblings. Clinicians should be aware that initial disease manifestations (hepatic or neuropsychiatric) often vary greatly in families<sup>45</sup>.

Beyond screening for KF rings, the clinical diversity in WD always requires diagnostic confirmation by testing for abnormal copper metabolism or gene mutation. Serum Cp concentration characteristically is <50% reduced, although it can be normal in WD (especially with WD hepatitis)<sup>49</sup>. Total serum copper concentration in WD is low, although free copper is elevated. 24-Hour urinary copper excretion is >100 µg, (normal values: <50 µg)<sup>40</sup>.

With equivocal laboratory findings and especially in the context of hepatic involvement, liver biopsy is needed for histological study and for measurements of tissue copper content. In WD, hepatic copper is >250 µg/g dry tissue<sup>45</sup>. Borderline changes in serum Cp and copper concentrations in serum, liver and urine, may be observed in other liver disorders and *ATP7B* mutation heterozygotes can also

demonstrate mild abnormalities. Further investigation can utilize the uptake and distribution of radiolabelled copper. The lack of a “second peak” (indicating labeled copper incorporation into Cp) implicates WD.

DNA analysis for *ATP7B* mutation often confirms a diagnosis of WD. However, screening tests targeted at the most frequent mutations in a particular regional population are often inconclusive. In these circumstances, sequencing the entire gene can provide diagnostic confirmation. DNA analysis is especially valuable for diagnosis of pre-symptomatic relatives of previously diagnosed WD patients<sup>50</sup>. For a definite diagnosis, mutations on both alleles of the WD gene must be found.

Other testing can enhance suspicion of WD. In some instances, neuroimaging can point to WD even with inconclusive copper metabolism and DNA studies. In mild WD, CT brain scans can be normal, though more severe cases have bilateral hypodensities in basal ganglia and other deep structures. Unlike CT, almost all cases of neurological WD have abnormalities on brain MRI (especially high signal intensities on T2-weighted and FLAIR images, typically in putamen, globus pallidus, caudate, thalamus, midbrain, pons, and cerebellum). In these structures, T1-weighted images may show hypointensities<sup>45</sup>.

#### *Deficiency of Ceruloplasmin in Iron Metabolism and its Association with Neurodegenerative Movement Disorders*

Recently, a Cp gene-deficient mouse model was developed<sup>16</sup>. Increased iron deposition in the cerebellum and brainstem was found in the brains of these adult mice. Motor incoordination was observed in association with a loss of brainstem dopaminergic neurons. These results indicate the important roles of Cp in protecting the brain from iron-mediated free radical injury.



The group of neurodegenerative movement disorders associated with increased brain iron content can be divided into two groups<sup>51</sup>:

(1) parkinsonian syndromes associated with brain iron accumulation, including PD, DLB, MSA-P, PSP, CBGD and HD, and

(2) monogenetically caused disturbances of brain iron metabolism associated with parkinsonian syndromes, including aceruloplasminemia, hereditary ferritinopathies affecting the basal ganglia, and pantothenate kinase associated neurodegeneration type 2.

All these disorders have two features in common: brain iron accumulation predominating in the basal ganglia and abnormal movements as predominant neurological disturbance. Although it is still unclear whether iron accumulation is a primary cause or secondary event in the first group, there is no doubt that iron-induced oxidative stress contributes to neurodegeneration. In comparison with monogenetically determined causes of brain iron accumulation, iron overload in the PD and atypical parkinsonian syndromes is small<sup>52</sup>. The use of metal chelators has been applied with moderate success with the second group. But the effect of such therapy in the first group remains to be elucidated. These disorders will be reviewed in the following in regards to their association with abnormal function of Cp and dysregulation of iron metabolism.

ศูนย์วิทยทรัพยากร  
จุฬาลงกรณ์มหาวิทยาลัย

*Association of Abnormal Iron and Copper Homeostasis with Monogenic Hereditary Movement Disorders*

*Aceruloplasminemia:*

In aceruloplasminemia, mutation in the Cp gene results in early termination of translation<sup>53</sup>. Thus, the synthesized Cp is truncated and lacks its C-terminal part that should provide the amino acid ligands for all the copper ions of the catalytic center. In a review by Hellman and Gitlin<sup>54</sup>, it is reported that there are at least six missense mutations in Cp gene, six frame-shifts, three splice site and two nonsense mutations that cause aceruloplasminemia.

The deficiency in Cp causes marked hemosiderosis in many of these patients. Serum levels of iron are mostly low, but only mild anemia is detected<sup>54</sup>.

Neurological symptoms usually occur when the patients are in their 40's, which can be explained by substantial accumulation of iron in the basal ganglia and retina. The deleterious effect of iron is likely to be strengthened by the presence of its ferrous form in the serum where it is readily absorbed by the tissues. Iron deposition in aceruloplasminemia is more pronounced in astrocytes than in neurons. Along with neurodegenerative features and symptoms of retinal degeneration, this condition is manifested by insulin-dependent diabetes mellitus which is also caused by iron deposition in the Beta-cells of the Langerhans islets. Neuronal cell death in aceruloplasminemia is a consequence of free-radical stress. A biochemical mechanism that is likely to contribute to the cell death is increased lipid peroxidation provoked by ferrous iron that is not oxidized by invalid Cp. High levels of lipid peroxidation in aceruloplasminemia have been evidenced in various organs, including the brain. Since larger amounts of irons are deposited in astrocytes than in neurons, free radicals

would appear to damage mostly the glial cells<sup>54</sup>. The loss of function by the glia further reduces the chances of survival of the neurons which also suffer from oxidative stress and thus the overall negative effect of iron overload on the neural tissue is intensified.

Brain iron accumulation in aceruloplasminemia is shown by decreased T1 signal and increased T2 signal in MRI. Neurologically, patients develop progressive extrapyramidal symptoms, cerebellar ataxia and dementia. Laboratory findings include complete absence of serum Cp, decreased serum iron content, increased serum ferritin and microcytic anemia. Elevated total iron binding capacity (TIBC) in aceruloplasminemia can distinguish it from other conditions with systemic iron overload such as hemochromatosis.

#### *Hereditary Ferritinopathy:*

The first hereditary ferritinopathy is named neuroferritinopathy, as this rare autosomal dominant disorder is characterized by the lack of clinical signs of systemic iron overload<sup>55</sup>. Only low serum ferritin levels may be detected, whereas iron levels and liver function are not altered. Brain iron accumulation predominates in the basal ganglia, leading to extrapyramidal symptoms such as rigidity, choreoathetosis, dystonia, and spasticity<sup>56</sup>, with MRI showing cavitations of the basal ganglia and iron accumulation. Symptoms usually start between the third and sixth decade of life. The second autosomal dominant hereditary ferritinopathy progresses gradually, affecting first striatal and cerebellar and later cortical functions from the third decade on<sup>57</sup>. Dysfunction of the liver is reported. The more systemic character of this disorder is confirmed by typical intranuclear and intracytoplasmic inclusion bodies, not only found in the gray and white matter of the brain, but also in skin, kidney, liver, and

muscle upon biopsy<sup>57</sup>. By linkage analyses, these disorders were mapped to 19q13.3, which contains the L-ferritin gene. Until now, three different mutations have been found to be causative for iron accumulation in hereditary ferritinopathies. L-ferritin is one of the two isoforms of the main iron storage protein within the brain. The distribution of L-ferritin and H-ferritin varies between tissues, with the brain containing larger amounts of H-ferritin. Despite considerable homology, the two isoforms differ in function. The H-subunit has a specific ferroxidase activity oxidizing ferrous iron, and is, therefore, involved in iron uptake and release. In contrast, the L-subunit is involved in the initiation and stabilization of the ferritin core, and therefore, in the long-term storage of iron. It is proposed that mutations found in patients with hereditary ferritinopathy disrupt the C-terminus of the L-chain, affecting its stability and function. Alternatively the C-terminus of the mutated L-chain may interfere with the formation of holo-ferritin, leading to an inadequate release of iron from ferritin or that mutated holo-ferritin has an impaired capacity to take up iron, leaving unbound iron with its capacity to induce the formation of toxic free radicals in the cytosol<sup>55, 57</sup>.

#### *Neurodegeneration with Brain Iron Accumulation Type 1:*

Neurodegeneration with brain iron accumulation (NBIA, formerly Hallervorden-Spatz syndrome) encompasses a group of rare autosomal recessively transmitted neurodegenerative disorders, characterized by radiographic evidence of excessive brain iron accumulation predominating in the basal ganglia and by progressive extrapyramidal symptoms<sup>58</sup> (Figure 8). According to the age of onset, early-onset childhood, late onset-childhood, and adult types of NBIA are differentiated with extrapyramidal dysfunction, such as rigidity, dystonia, and choreoathetosis, as obligate features. Additional features include corticospinal tract

involvement, progressive dementia, epileptic seizures, retinitis pigmentosa and/or optic atrophy. MRI usually enables the depiction of the excessive iron accumulation in the lentiform nucleus (typical but non-specific eye of the tiger sign), substantia nigra and dentate nucleus. In addition to abnormal cytosomes in circulating lymphocytes and/or sea blue histiocytes in bone marrow, there is no evidence for systemic dysregulation of iron metabolism. In addition to large amounts of intra- and extracellular iron neuronal loss and gliosis, isopathological hallmarks include Lewy bodies and Lewy neurites. Until very recently the disorder could only be verified by postmortem diagnosis. The identification of deletions and missense and null mutations in the coding regions of the pantothenate kinase 2 gene (PANK2)<sup>59</sup> in several patients with classic and atypical NBIA has led to the classification of one major subgroup in this heterogenous group of disorders, including pantothenate kinase-associated neurodegeneration or NBIA type 1. Pantothenate kinases are essential for coenzyme A biosynthesis, which is crucial for intermediary and fatty acid metabolism. The role of PANK2 in iron metabolism is still under debate. Accumulation of cysteine, a metabolite of PANK2, is proposed which undergoes rapid auto-oxidation in the presence of iron, resulting in free-radical production and induction of lipid peroxidation<sup>59</sup>. It seems that although PANK2 is not directly involved in iron metabolism, its loss of function may contribute to iron accumulation and free-radical-mediated neuronal death.

**Figure 8: Brain MRI Showing Iron Deposition, Mimicking “Eyes of the Tiger”, in a Patient with Pantothenate Kinase Associated Neurodegeneration (PKAN)**

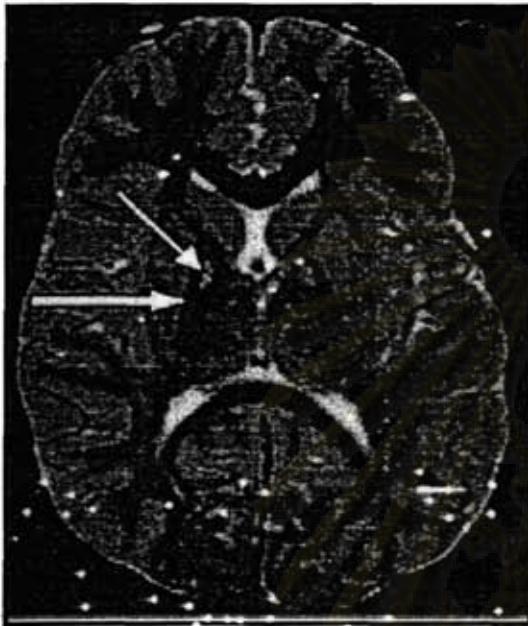

### *Menkes' Disease*

Menkes' disease is a disorder in which copper absorption in the gastrointestinal tract is disturbed<sup>60</sup>. It is an X-linked recessive disease that occurs in approximately 1 in 200,000 live births. The condition is characterized by skeletal abnormalities, severe mental retardation, cerebellar ataxia and changes in hair structure (“kinky-hair syndrome”) in early childhood and early mortality. The clinical features of Menkes' disease result from a deficiency of serum copper and copper-dependent enzymes. A candidate gene for the disease has been isolated and designated as MNK. The MNK gene codes for a P-type cation transporting ATPase, based on homology to known P-type ATPases and in vitro experimentation. The Menkes' protein functions to export excess intracellular copper and activates upon copper I binding to the six metal-binding repeats in the amino-terminal domain. The

loss of Menkes protein activity blocks the export of dietary copper from the gastrointestinal tract and causes the copper deficiency associated with Menkes' disease.

### *Association of Abnormal Iron and Copper Homeostasis with Sporadic Movement Disorders*

#### *Evidence of Abnormal Cp mutation and Iron Accumulation in Parkinson's Disease:*

PD is characterized mainly by the loss of pigmented dopaminergic neurons in the substantia nigra pars compacta with subsequent striatal dopamine deficiency (Figure 9). Oxidative stress leading to an increased production of reactive oxygen species is thought to be a major component in the pathogenesis of PD. This is supported by evidence of increased levels of lipid peroxidation markers, depletion of reduced glutathione and impaired mitochondrial complex I activity. Excessive intraneuronal iron accumulation has been found in the substantia nigra of patients with PD and it can be detected clinically by transcranial ultrasound<sup>61, 62</sup> (Figure 10). Regional iron increase in PD suggests a probable associated abnormality in the regulation of iron metabolism. It is still a matter of debate whether iron accumulation is a primary event initiating or promoting the cascade of neurodegeneration or rather a consequence of the degenerative process. First findings in incidental Lewy body disease, considered as a preclinical form of idiopathic PD, did not reveal increased iron levels, suggesting that iron may accumulate later in the disease process (Figure 11). However, recent finding in a small number of substantia nigra in autopsy of patients with preclinical PD, did reveal increased iron levels. Therefore, further studies are necessary to solve this question.

Evidence suggesting that iron may play a primary role in the neurodegenerative process come from the following<sup>52</sup>:

(1) Long-term occupational exposure to different combinations of metals including iron, have been associated with PD. Moderate association between iron intake from food and PD has also been shown. However, these findings alone still cannot account for the majority of PD cases. Additional factors such as disturbance of the blood brain barrier, thereby allowing the entrance of these metals into the CNS, have to be considered.

(2) Animal model for PD created by intrastriatal 6-hydroxydopamine (6-OHDA) infusion, which has selective cytotoxicity targeting the basal ganglia, showed that animal models are resistant to 6-OHDA toxicity in the presence of iron deficiency. The animal study also showed that 6-OHDA-induced neurodegeneration may be prevented by iron chelator. Such finding suggests that increased iron content may indeed play a key role in this model of PD. Similarly in unilaterally 1-methyl-4-phenyl-1,2,3,6-tetrahydropyridine (MPTP)-injected monkeys with contralateral hemiparkinsonism, dietary iron restriction and iron chelators were shown to attenuate MPTP toxicity. This further indicates that iron does play an important role in these animal models. Brain iron accumulation in animal models created to reflect a dysregulation of brain iron metabolism also supports the idea of a primary association of iron and abnormal movements and neuropathology. In the IRP2 knockout mouse brain, iron accumulation is accompanied by features such as bradykinesia and tremor. The heterozygous H-ferritin knockout mouse was found to have a decreased ferritin/iron ratio accompanied by several indices of oxidative stress similar to what is found in PD.



(3) The discovery that mutations in and multiplications of the  $\alpha$ -synuclein gene account for monogenetically caused PD and that  $\alpha$ -synuclein is a prominent component of Lewy bodies, aggregation of this protein has become widely accepted to be involved in the pathogenesis of PD. Meanwhile, several studies have suggested that iron interacts with  $\alpha$ -synuclein, enhancing the conversion of unfolded or  $\alpha$ -helical conformation of  $\alpha$ -synuclein to  $\beta$ -pleated sheet conformation, the primary form in Lewy bodies. Colocalization of iron as well as Cp, protein known to involve in brain iron metabolism and Lewy bodies further implicates the involvement of iron in the neurodegenerative process in PD.

Despite this large amount of evidence for a contribution of iron to the neurodegenerative process in PD, it has to be taken into account that PD is not a disorder of the substantia nigra alone, but rather an ascending neurodegenerative disease, involving different brain structures. Therefore, it remains to be determined, whether disturbances of iron metabolism also play a role in other brain areas affected in PD.

Recent studies have shown that neurodegenerative disorders are associated with brain iron accumulation and mutations in genes encoding proteins of iron metabolism, reinforcing the hypothesis of impaired brain iron metabolism in PD. As mentioned above, the role of Cp in brain iron metabolism has been verified by the loss of function mutations in the Cp gene in hereditary aceruloplasminemia and by Cp-deficient mice displaying brain iron accumulation. In such mice models, iron-induced oxidative injury was evidenced by increased lipid peroxidation and by mitochondrial dysfunction of the basal ganglia<sup>63</sup>. Parkinsonism was also reported to be present in some cases of aceruloplasminemia. Furthermore, immunohistochemical studies have demonstrated the co-localization of Cp with Lewy bodies, the pathological hallmark

of PD<sup>1</sup>. These data underlie a possible role of Cp in the pathogenesis of PD and perhaps in other neurodegenerative diseases. Screening of the Cp gene in a cohort of PD patients in comparison to matched controls, Hochstrasser et al<sup>1</sup> reported three missense-mutations and observed an association of 163T with PD, the R793H substitution in association with increased hyperochogenicity of the substantia nigra and the D544E to be associated with both. Functional impact of these three Cp missense mutations on *holo*-Cp biosynthesis and ferroxidase activity was further studied<sup>2</sup>. It was observed that, in vivo, the 163T mutation resulted in half the normal Cp concentration and markedly reduced ferroxidase activity in serum from a heteroallelic PD patient. Furthermore, the D544E polymorphism resulted in significantly reduced serum Cp levels and ferroxidase activity in heteroallelic patients and in expression of mainly *apo*-Cp in cell culture. Thus, this evidence support the hypothesis that D544E polymorphism may present as a genetically predisposed vulnerability factor for oxidative stress in the substantia nigra of PD patients, which directly links this mutation to substantia nigra iron accumulation in some PD patients and even in preclinical controls. The involvement of Cp in iron-induced oxidative stress may predispose genetically vulnerable individuals to the development of clinical phenotype of PD. Other environmental factors might be involved as additional predisposing factors.

There have been growing interests in the study of serum levels of Cp and iron parameters as peripheral markers for CNS oxidative damage. Copper-zinc superoxide dismutase (SOD1) is another important copper enzyme which dismutates the superoxide anion radical to the less toxic hydrogen peroxide and oxygen. It is found intracellularly in most tissues and is one of the major antioxidant in the CNS together with glutathione peroxidase and catalase. Torsdottir et al<sup>64</sup> studied the activity of

SOD1 in erythrocytes and the activity and concentration of Cp in the serum of 40 patients with PD and controls. It was shown that both Cp concentration and oxidative activity were on average significantly lower in the patients compared with the controls. Cp specific oxidative activity was also significantly lowered. SOD1 activity did not differ significantly between the patients and the controls, but it decreased significantly with the duration of disease. It was worth noting that Cp and SOD1 activity were not shown to decrease with age. In light of these data, it seemed likely that patients with PD might have increased vulnerability to oxidative stress, thus predisposing them to development of clinical PD. In a follow-up study five years later, Torsdottir et al<sup>65</sup> again reported that the oxidative activity and specific oxidative activity were on average significantly lower in the patient group compared to the control group. However, the follow-up study did not observe reduction of Cp oxidative activity in association with duration of disease. The Cp concentration in the control subjects did not show any change in Cp concentration, oxidative activity or specific oxidative activity in relation to age. Musci et al<sup>66</sup> also showed that Cp in serum undergoes conformational changes with age but retains its oxidative activity in healthy individuals.

ศูนย์วิทยุทรัพยากร  
จุฬาลงกรณ์มหาวิทยาลัย

Figure 9: SPECT DOPASCAN Beta-CIT Measures Dopamine Transporter.

Asymmetrical Loss of Presynaptic Dopaminergic Neurons are Observed in Patient with Parkinson's Disease

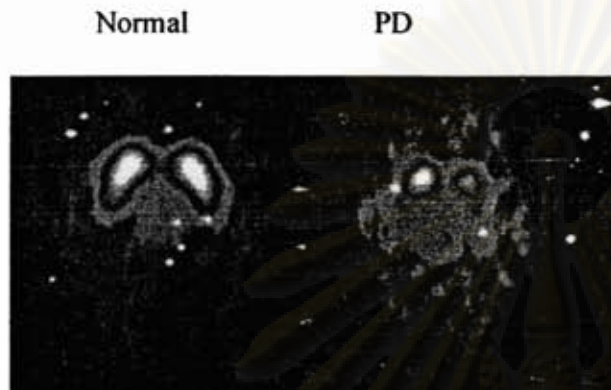
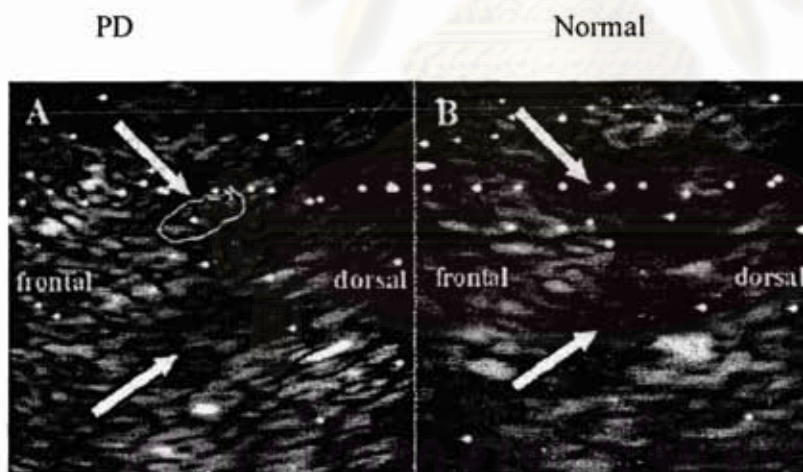

Figure 10: Hyperechogenicity of the Substantia Nigra in Patient with Parkinson's Disease and Normal Control



จุฬาลงกรณ์มหาวิทยาลัย

Figure 11: Positive Immunohistochemistry Staining for Ceruloplasmin in Lewy Bodies

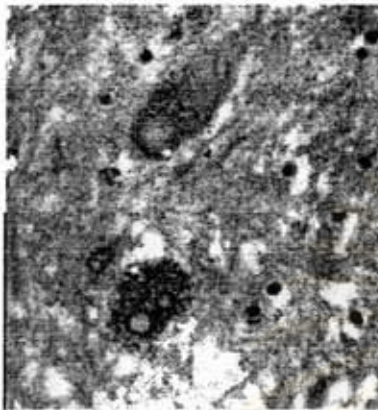
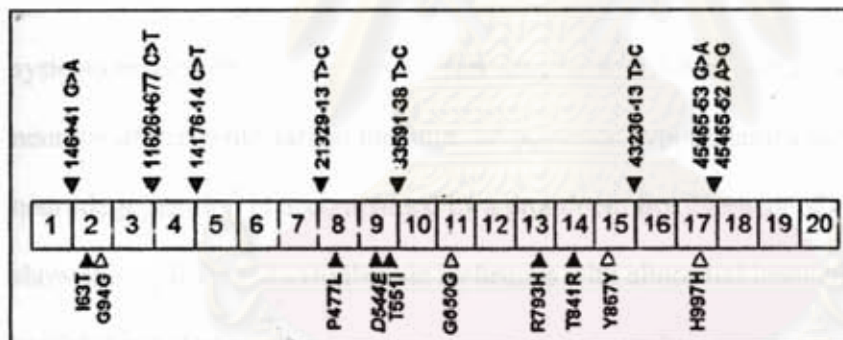

Figure 12: Novel Missense Variation of Ceruloplasmin Gene in Patient with Parkinson's Disease



### *Iron in other Sporadic Neurodegenerative Movement Disorders*

#### *Dementia with Lewy Bodies (DLB):*

There are only few reports on changes of iron levels in DLB, which is clinically characterized by the core features of fluctuating cognition with pronounced variation in attention and alertness, recurrent visual hallucinations, and spontaneous motor features of parkinsonism<sup>52</sup>. However, DLB shares many features of with PD

with respect to Lewy pathology, consisting of Lewy bodies and Lewy neuritis.

Investigation of parameters of oxidative stress in patients with DLB revealed the same findings as in patients with idiopathic PD, indicating a similar pathophysiologic process. The use of transcranial ultrasound, the same alterations indicative for an increased substantia nigra iron content have been found.

#### *Multiple System Atrophy-P (MSA-P)*

In MSA-P, parkinsonism that may start asymmetrically in the majority of cases and includes in addition to rigidity and bradykinesia frequently postural and less often resting tremor is poorly responsive to levodopa. The characteristic dysautonomia consists primarily of urogenital and orthostatic dysfunction<sup>67</sup>.

Neuropathologically prominent features are neuronal loss in the putamen, substantia nigra and usually also in the olivopontocerebellar system, as well as in several cell systems responsible for autonomic function, such as dorsal motor vagus nucleus neurons of the ventrolateral medulla and posterior hypothalamus nucleus. The neurodegeneration is accompanied by a prominent involvement of glial cells that show the typical glial cytoplasmic inclusions with abnormal insoluble form of oxidated/nitrated  $\alpha$ -synuclein as a major component. Increased concentrations of iron have been described primarily in the putamen (Figure 13), but also in the substantia nigra and caudate nucleus in postmortem and magnetic resonance imaging (MRI) studies<sup>68</sup>.

จุฬาลงกรณ์มหาวิทยาลัย

Figure 13: Coronal Section of MSA Brain Showing Atrophy and Greyish Iron Depositions in Bilateral Putamen.

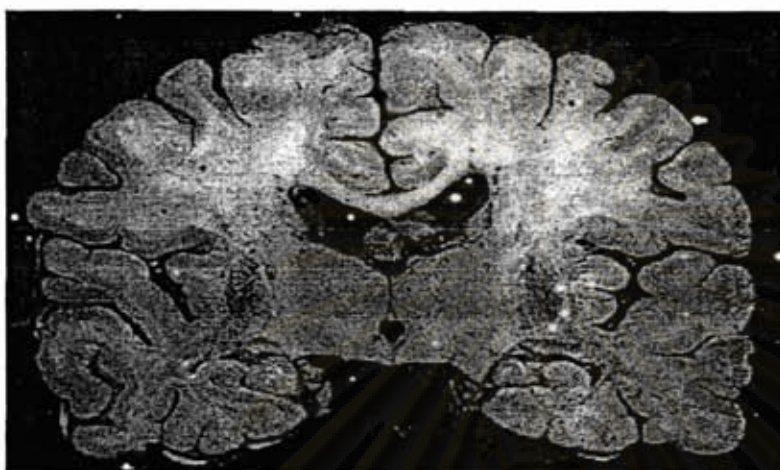

#### *Progressive Supranuclear Palsy (PSP)*

PSP, clinically characterized by vertical gaze palsy or slowing of vertical saccades and prominent postural instability with falls in the first year in addition to bradykinesia, mostly symmetric rigidity, and frequently frontal behavioral abnormalities or dementia, is associated with atrophy primarily involving the midbrain and the cortex. Neuropathologically, neuronal loss, atrophy, gliosis, and accumulation of neurofibrillary tangles, derived mainly from the microtubule-associated tau protein, are found in brainstem nuclei and the cortex. Marked increase of iron has been detected in the substantia nigra and to a lesser extent and later in the disease than in MSA-P in the putamen<sup>68</sup>. In vivo, brain tau accumulation in PSP has been shown to colocalize with ferritin<sup>68</sup>. Similarly to  $\alpha$ -synuclein, iron has been shown to interact with tau protein inducing tau polymers and modulating the formation of tau aggregates.

Despite the elevated iron levels, substantia nigra echogenicity is far less enhanced in MSA-P and PSP than in idiopathic PD. This finding might be because the increased iron levels in these atypical parkinsonian samples seem to be bound to increased levels of ferritin, whereas in idiopathic PD, iron normally is bound to ferritin seems to account only for a small amount of the increased iron levels. Therefore, differences in molecular structure due to alterations in binding properties or iron sequestered by other molecules seem to be responsible for the changes in echomorphology as observed in idiopathic PD.

#### *Corticobasal Ganglionic Degeneration (CBGD)*

Similarly, CBGD is associated with markedly increased substantia nigra echogenicity. CBGD is clinically characterized by cortical dysfunction reflected by at least one symptom, such as focal or asymmetrical ideomotor apraxia and/or myoclonus, alien limb phenomena, constructional or speech apraxia, cortical sensory loss, or nonfluent aphasia. Symptoms of extrapyramidal dysfunction must include focal or asymmetric appendicular rigidity lacking sustained L-Dopa response or focal or asymmetrical dystonia. Variable degrees of cognitive dysfunction occur. Neuropathologically focal cortical and substantia nigra neuronal loss as well as cortical and striatal tau-positive neuronal and glial lesions are regarded as core features. Cortical atrophy, ballooned neurons, and tau-positive oligodendroglial coiled bodies are additionally found. Neuropathological reports about iron in CBGD are scarce. Marked iron accumulation of the substantia nigra has been described in three patients with typical CBGD, whereas widespread iron deposition throughout the central nervous systems has been detected in a patient with atypical CBGD<sup>69</sup>. Since transcranial ultrasound study suggests similar changes as seen in idiopathic PD, it



remains to be seen whether the substantia nigra iron binding profile resembles the one found in idiopathic PD.

For all these atypical parkinsonian syndromes, the source of iron accumulation is still unclear. For accumulation of iron in the substantia nigra, it has been suggested that dysfunction of striatonigral/striatopallidal GABA neurons may result in the disruption of zona reticularis iron homeostasis.

#### *Huntington's Disease (HD)*

In HD, brain iron and ferritin accumulation has been detected in the putamen, caudate nucleus, and globus pallidus by MRI and postmortem investigations<sup>68</sup> (Figure 14). These higher iron levels have been found already early in the disease process and, therefore, have been regarded as putative risk factors. It seems that especially those iron-rich areas that receive major excitatory input from the cortex, such as the caudate nucleus and the putamen, are affected by the disease, whereas other iron-rich regions with less excitatory transmission or areas with dense N-methyl-D-aspartate receptors but lower iron concentrations are less severely affected. This constellation may argue in favor of an enhancing adverse effect of iron and excitatory transmission<sup>70</sup>. The question of the origin of the increased iron levels in HD is still controversial. A CAG trinucleotide expansion (>38 repeats), resulting in the mutation of protein, Huntingtin, was found to be the genetic cause of this disorder. Studies in Hdhex4/5/Hdhex4/5 knockout stem cells implicate that huntingtin is both essential for proper regulation of the iron pathway and an iron-regulating protein<sup>71</sup>. Moreover, low serum ferritin levels<sup>72</sup> and slightly elevated Cp levels<sup>19</sup> in the brain indicate a more generalized

dysregulation of iron metabolism. Further studies are needed to determine the exact interactions and role of iron in the pathogenesis of HD.

Figure 14: Neuronal Loss & Gliosis of Caudate nucleus in Huntington Disease Brain

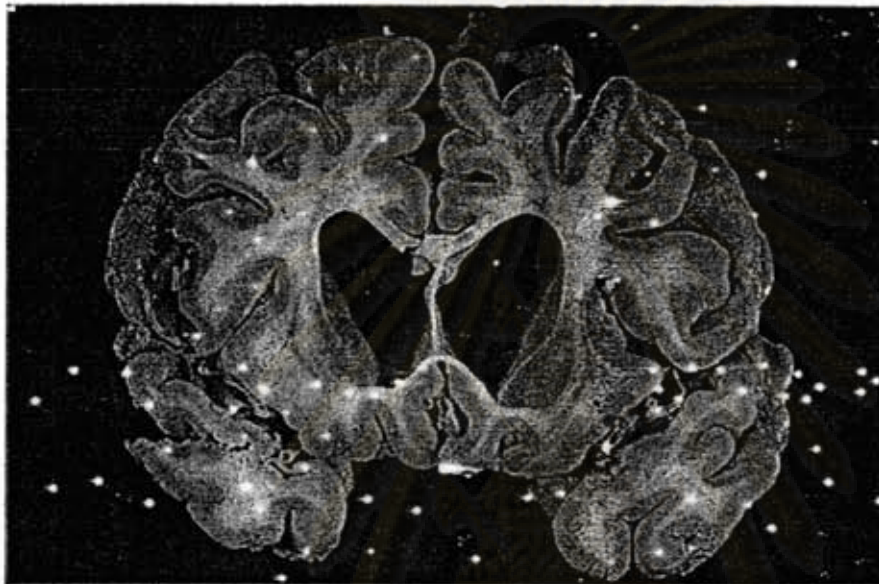

*Other Non-Neurodegenerative Movement Disorders:*

There is no doubt that the role of Cp, regulation of iron and copper homeostasis are closely linked in neurodegenerative disorders, in which many conditions manifest with features of abnormal movements. The frequent association with basal ganglion circuit abnormalities in these conditions suggests possible increased vulnerability of basal ganglia or dopaminergic neurons and their susceptibility to dysfunction. It is still uncertain whether Cp plays a primary or secondary role or merely an epiphenomenon of the common pathway of neuronal dysfunction in these movement disorders. It might be of interest to study other non-neurodegenerative movement disorders to ascertain whether the involvement of Cp is

specific to the neurodegenerative process. Since non-neurodegenerative movement disorders will also be included in this study, selective disease entities are reviewed in the following.

### *The Role of Iron in Restless Legs Syndrome*

The impressive relief from restless legs syndrome (RLS) symptoms provided by levodopa treatment indicates RLS is related to dopaminergic abnormality. But similar and more lasting relief also occurs for iron treatment in some patients. Thus there are two major putative causes for RLS<sup>73</sup>:

- (1) CNS dopaminergic abnormality, and
- (2) CNS iron insufficiency

Brain iron insufficiency is supported by independently replicated cerebrospinal fluid and brain imaging studies for patients without iron deficiency anaemia. Two MRI studies have found significantly reduced iron content in the substantia nigra more marked for those patients with RLS whose symptoms started before they were 45 years old<sup>73</sup>. In both studies, MRI measurement of nigral iron concentration correlated inversely with clinical ratings of disease severity. Two CSF studies reported patients with RLS compared to matched controls had significant decreases in CSF ferritin and increases in CSF transferrin for samples obtained in the morning<sup>73</sup>. In these studies, in contrast to the CSF, the serum iron measures of ferritin and transferrin did not differ significantly between RLS and controls. Circadian changes in CNS iron status appear to be a significant factor in RLS. One study of CSF collected in the evening showed a significant CSF ferritin decrease compared to controls for patients with RLS with early-onset of symptoms<sup>73</sup>. Remarkable response to intravenous iron treatment in RLS patients also links brain iron insufficiency to RLS. The brain iron insufficiency

in patients with RLS is now well established. Autopsy studies from early-onset (before age 45) patients with RLS provide strong confirmation of the brain iron deficiency in RLS. Examination of stained sections from the substantia nigra of patients with RLS and matched controls showed decreased iron and H-ferritin along with increased transferrin. L-ferritin was not decreased but it was concentrated in different cell types than normal. Since the majority of iron in the brain is stored in the oligodendrocytes, L-ferritin is normally substantially higher in these cell types. In RLS brains, however, astrocytic cells that normally have only mild L-ferritin staining had the major proportion of L-ferritin compared to surrounding tissue<sup>73</sup>. The mechanism behind this redistribution of iron to astrocytes rather than oligodendrocytes remains unexplained. However, this might explain the failure of iron although present to be adequately available for the neuron. It also raises concerns about the interpretation of MRI findings regarding RLS brain iron status. A failure to find a change in iron in a brain region does not exclude the possibility of abnormal iron redistribution and thus abnormal utilization. Thus, it is proposed that the combination of both dopamine abnormalities and iron insufficiency lead to the manifestation of RLS. Other factors may interact with the iron pathology to either enable or protect from RLS expression, but the iron pathology and possible resulting dopamine abnormality play central roles in the disease process in RLS.

#### *Essential Tremor and New Pathological Findings*

Essential tremor (ET) is a highly prevalent, progressive neurological disorder. There is growing evidence that it may represent a family of diseases rather than a single entity; evidence of clinical and genetic heterogeneity and variable response to medications supports this view. ET may be pathologically heterogeneous as well. The

pathology of ET, i.e. the structural manifestations of ET, is not well studied. A postmortem study<sup>74</sup> reveals the presence of anatomically restricted Lewy bodies in 8 out of 33 ET brains in the brainstem, mainly in the locus ceruleus. However, the majority of ET brains had no Lewy bodies, but had pathological changes in the cerebellum. The mean number of Purkinje cells was reduced in ET cases without Lewy bodies. ET without Lewy bodies also had degeneration of the dentate nucleus in two cases. Lewy body ET cases were older than ET cases without Lewy bodies; whereas in ET cases without Lewy bodies, a younger age of onset of tremor and higher proportions with gait difficulty and family history were found. The pathological changes of ET appear to be heterogeneous and degenerative. However, the clinical differences between ET with or without Lewy bodies require additional study. Whether a proportion of ET patients have limited form of Lewy body disease or undergoing neurodegenerative changes remain unclear.

*Previous Studies on Serum Ceruloplasmin Levels in Non-Wilsonian Movement Disorders:*

There has only been limited number of studies that analyze serum Cp levels in patients with non-Wilsonian Movement Disorders. Walshe retrospectively studied the serum Cp levels in patients who were referred to a Wilson's disease clinic<sup>3</sup>. Forty patients with neurological presentations, who did not receive a final diagnosis of Wilson's disease, were studied. Nineteen (47.5%) of these patients had low Cp levels. All but one of these 40 patients presented predominantly with abnormal movements. The various diagnosis among patients with reduced serum Cp levels included Huntington's disease, subacute sclerosing panencephalitis (SSPE), Pantothenate kinase-associated neurodegeneration (PKAN) and aceruloplasminemia. These results

highlighted the possible values in measuring serum Cp levels for the investigations of patients with abnormal movements.

A systematic analysis of serum Cp levels is therefore warranted for patients with non-Wilsonian movement disorders. As far as we are concerned, there has been no previous prospective study on the serum measurements of Cp, copper and iron parameters in patients with different movement disorders.

### 2.3 Measurement of Serum Ceruloplasmin

Measurements of serum ceruloplasmin and copper are often requested in clinical practice to investigate the potential for their excess or deficiency states. In Wilson's disease, increased urinary copper and decreased serum level of *holo-Cp* are found. Primary copper excess in WD results in copper deposition in the hepatic parenchymal cells, the brain, the periphery of the iris and the kidney. In the absence of obvious neurological changes or Kaiser-Fleischer rings, the diagnosis of WD can be a challenge. Secondary copper excess is also possible, especially in people in the developing countries, through dietary source. Primary copper deficiency presenting in childhood is often caused by Menkes' disease, an inherited defect in copper absorption, and has a poor prognosis. Decreased serum level of *holo-Cp* is found in Menkes' disease. Primary copper deficiency can also occur in adults as a neurological condition mimicking the extrapyramidal signs of WD. Secondary or acquired copper deficiency is reported in patients who are supported with long-term enteral nutrition and with overuse of zinc supplementation. Early diagnosis of copper deficiency is essential because early recognition and prompt copper supplementation can prevent neurological deterioration.

Most of the copper in the serum is transported bound to Cp; the rest is bound to albumin, transcuprein and copper-amino acid complexes. Serum levels of Cp and copper may be influenced by various medical conditions and gender, but laboratories often do not take these into account when reporting reference intervals. Furthermore, Cp has 6-8 copper atoms per molecule, with most being tightly bound. As a result, serum Cp may show considerable heterogeneity in the number of copper atoms per molecule. Thus, any formula that is used to calculate Cp-bound copper assuming that six copper atoms bind per molecule of Cp may be valid only in certain situations and also be subjected to limitations. Since serum Cp is synthesized by the liver, decreased levels of Cp are found in primary biliary cirrhosis, primary biliary atresia, and in some cases of severe hepatitis. The decreased levels are due to the limitations of total liver metabolism rather than to a defect in specific Cp synthesis. As Cp is increasingly expressed during the acute-phase response it is generally detected in elevated levels during all inflammatory diseases. In addition, raised levels are seen in reticuloendothelial neoplasia, biliary obstruction, estrogen therapy, and pregnancy.

As the serum level of copper is largely determined by that of Cp, this should be taken into account when interpreting copper levels. Some patients with WD have serum levels of copper and Cp within their respective reference range. About 2% of the population is heterozygotic for P-type adenosine triphosphatase mutations and often has Cp levels around the lower reference interval. An equation has been derived to adjust the serum concentration of copper for that of Cp:

$$[\text{adjusted copper}](\mu\text{mol/l}) = [\text{total copper}](\mu\text{mol/l}) - 0.052 \times [\text{Cp}](\text{mg/l}) + 17.5(\mu\text{mol/l})$$

Adjusted copper for Cp is in many ways different from adjusted calcium for albumin. Unlike unbound calcium, which is under hormonal control, it is still unclear what controls the unbound copper level. Furthermore, whereas roughly half the serum

calcium is bound to albumin, most of the serum copper is bound to Cp. Therefore, the copper level adjusted for Cp is a way of making copper better understood. By enabling adjustment, especially for relatively high levels of Cp, it would answer to why copper level is slightly raised when the Cp is at the upper end of the reference interval.

Various methods have been described for the measurement of Cp; however, at present, there is no standardized method for Cp. The most commonly used methods are turbidimetry, nephelometry and radial immunodiffusion. Immunological methods used for Cp might cross react with apo-Cp, leading to misinterpretation of the results. In this study, immunoturbidimetric assay is used. Cp from serum sample forms a precipitate with a specific antiserum which is determined turbidimetrically at 340nm. For serum sample collection and preparation, only clotted blood collection tubes should be used. Serum sample should be analyzed promptly on the same day of specimen collection. Once in the laboratory, the serum samples are automatically prediluted 1:21 with NaCl solution by the instrument. Stability of the diluted sample lasts for 3 days at 2-8°C or 4 weeks at -15 to -25°C. Samples with precipitates should be centrifuge before performing the assay. Assay is performed with the reagent by COBAS INTEGRA® Roche® in an analyzer, which automatically calculates the analyte concentration of each sample.

#### *Limitations – Interference*

Criterion: Recovery within  $\pm 10\%$  of initial value.

Icterus	- No significant interference.
Hemolysis	- No significant interference.
Lipemia	- No significant interference up to an L index of 50. No



	significant interference up to 2500 mg/dL triglycerides. There is poor correlation between the L index and triglycerides concentration.
Rheumatoid factors	- No significant interference up to a rheumatoid factors level of 400 IU/mL.
Other	- In very rare cases gammopathy, in particular type IgM (Waldenstrom's macroglobulinemia), may cause unreliable results

For diagnostic purposes, the results of Cp should always be assessed in conjunction with the patient's medical history, clinical examination and other findings.

*Measuring range:*

Standard measuring range	8.00 – 140 mg/dL
Extended measuring range	4.00 – 420 mg/dL (calculated)
Lower detection limit	3.00mg/dL
	The detection limit represents the lowest measurable analyte level that can be distinguished from zero. It is calculated as the value lying three standard deviations above that of a zero sample

*Expected Values:*

Reference range for the assay employed for this study is 20.00 – 60.00 mg/dL.

It is recommended that each laboratory to investigate the transferability of the

expected values to its own patient population and if necessary determine its own reference ranges.

*Specific Performance Data:*

Reproducibility of this assay was determined using human samples and controls in an internal protocol (within-run  $n = 20$ , total  $n = 20$ ) by Roche®. The following results were obtained:

	Level 1	Level 2
Mean	0.20 g/L (20.4 mg/dL)	0.35 g/L (34.7 mg/dL)
CV within-run	3.6%	2.4%
CV total	3.9%	2.7%

ศูนย์วิทยุทรัพยากร  
จุฬาลงกรณ์มหาวิทยาลัย

## CHAPTER 3

### RESEARCH METHODS

#### 3.1 Objectives

The aims of this research study were: (1) to measure the serum Cp levels in Thai patients with different non-Wilsonian movement disorders; and (2) to compare the means serum Cp levels between these patients and healthy controls.

#### 3.2 Research Questions

Primary Research Questions:

- c. What is the serum ceruloplasmin level in patients with non-Wilsonian movement disorders?
- d. Is the serum ceruloplasmin level significantly higher in patients with non-Wilsonian movement disorders when compared with healthy controls?

ศูนย์วิทยทรัพยากร  
จุฬาลงกรณ์มหาวิทยาลัย

### 3.1 Research Methodology

<p><b>Study Design</b></p>	<p>This is a case-control analytical study. We obtained serum samples from patients who attended the Chulalongkorn Comprehensive Movement Disorders Center at King Chulalongkorn Memorial Hospital from 1<sup>st</sup> October 2007 to 31<sup>st</sup> March 2008. Patients were required to have predominant symptoms of abnormal movements and had obtained a definite clinical diagnosis of movement disorders. We collected control samples from healthy blood donors who attended the Thai Red Cross Blood Bank on 1<sup>st</sup> November 2007 and 8<sup>th</sup> November 2007.</p> <p>All serum samples were sent for laboratory tests including serum levels of Cp, iron, copper, ferritin, total iron binding capacity and GGT. Results of the laboratory tests were analyzed and studied.</p>
<p><b>Case Population</b></p>	<p>Hospital-based population which comprised of Thai adult patients with non-Wilsonian movement disorders</p>
<p><b>Sample Population</b></p>	<p>Hospital-based adult patients with definite diagnosis of movement disorders who attended the King Chulalongkorn Memorial Hospital from 1<sup>st</sup> October 2007 to 31<sup>st</sup> March 2008.</p>
<p><b>Control</b></p>	<p>Healthy blood donors who attended the Thai Red Cross Blood Bank on 1<sup>st</sup> November 2007 and 8<sup>th</sup> November 2007. (see appendix F for</p>

	eligibility guidelines for volunteer blood donation)
<b>Inclusions Criteria:</b>	Subjects were included in our study if they were at the age of 18 years or over and provided informed consent (Appendix B).
<b>Exclusion Criteria:</b>	<ul style="list-style-type: none"> <li>- Documented Wilson's disease</li> <li>- Family history of Wilson's disease</li> <li>- Intercurrent infections</li> <li>- Malignancies</li> <li>- Abnormal renal function</li> <li>- Protein-losing nephropathy</li> <li>- Liver diseases</li> <li>- <math>\gamma</math>-glutamyl transpeptidase (GGT) <math>&gt; 150\text{U/l}</math></li> <li>- Dietary copper deficiency (<math>&lt;0.7\mu\text{g/ml}</math>)</li> <li>- Heavy metal exposure (such as occupational exposure)</li> <li>- Pregnancy</li> <li>- Intake of oral contraceptive pills or hormone replacement therapy</li> <li>- Serious medical conditions that might lead to systemic inflammatory response.</li> </ul>

Figure 15: Flow Chart to Illustrate Study Design

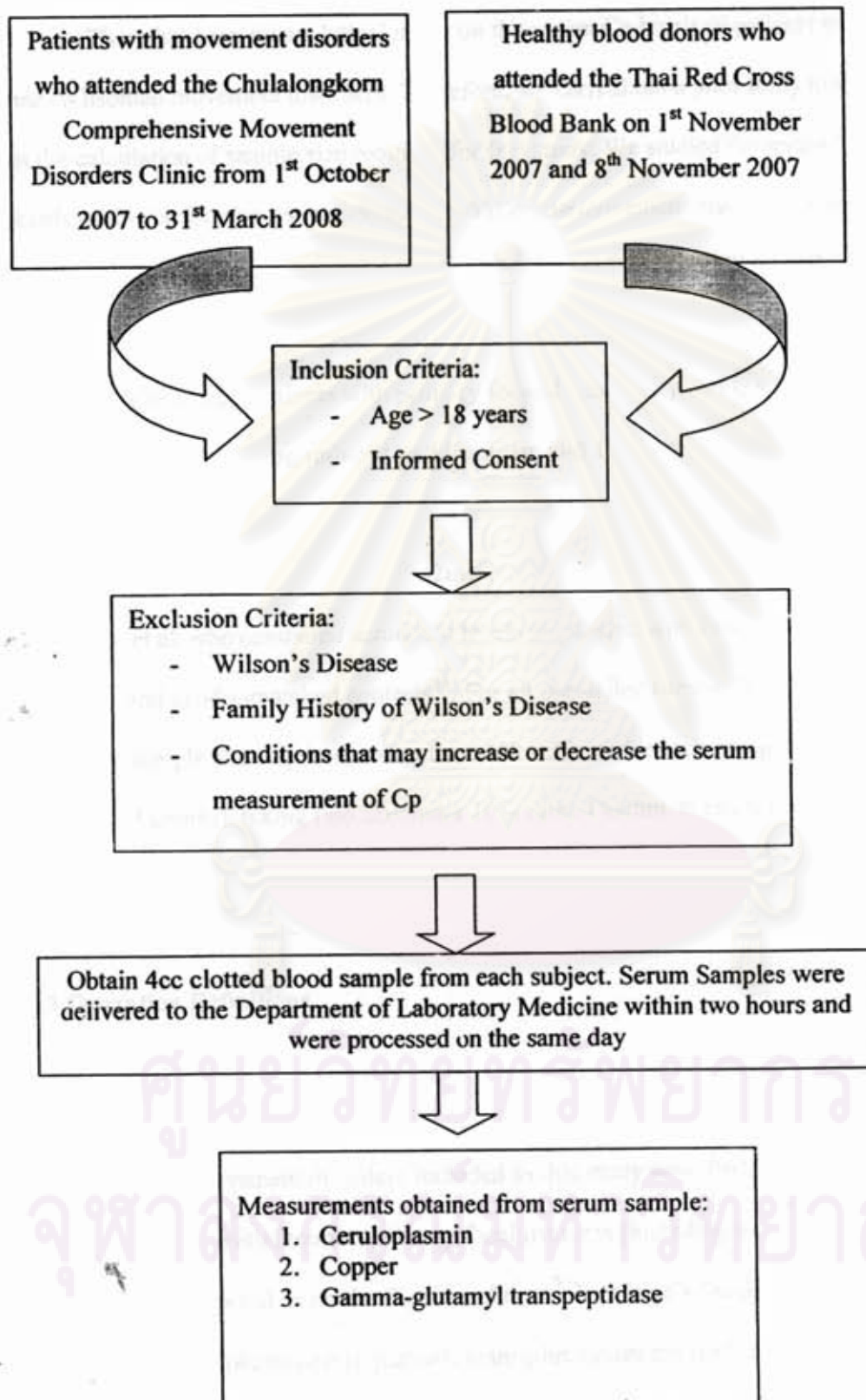

### 3.2 Sample Size Calculations

There has been no analytical study on the serum Cp levels of patients with non-Wilsonian movement disorders. Therefore, we carried out a pilot study to assist in the calculation of sample size required for this study. We studied the serum Cp levels of 26 consecutive patients with non-Wilsonian movement disorders, who attended the Chulalongkorn Comprehensive Movement Disorders Clinic at King Chulalongkorn Memorial Hospital in October, 2007. There were 16 patients with Parkinson's disease, 6 patients with primary focal dystonia, 2 patients with essential tremor, 1 patient with drug-induced parkinsonism and 1 patient with multiple system atrophy. The mean Cp level of the patient group was 18.47mg/dl. The value for mean serum Cp level for the control group (32mg/dl) was obtained from the study by Torsdottir et al, who compared serum Cp levels in patients with Parkinson's disease with age- and gender-matched controls<sup>65</sup>. For an one-tailed t-test with 80% power, the minimum sample size required was at least 102 subjects for each group (i.e. patient and control groups), taking into account a 10% rate of technical errors such as missing specimen (Appendix C).

### 3.3 Operation Definitions

Movement disorders:

- Movement disorders included in this study were Parkinson's disease, essential tremor, primary focal dystonia (including writer's cramp, cervical dystonia, focal hand dystonia, Meige's Syndrome and blepharospasm), parkinsonism-plus syndrome (including dementia

with Lewy bodies, progressive supranuclear palsy and multiple system atrophy), tardive syndrome (including tardive dyskinesia and tardive dystonia), vascular parkinsonism, Huntington's disease, familial myoclonus, post-infectious segmental myoclonus, late-onset sporadic cerebellar ataxia and Tourette's syndrome.

Neurodegenerative diseases:

- Diseases that were categorized as neurodegenerative diseases included Parkinson's disease, parkinsonism-plus syndrome and Huntington's disease.

Iron parameters:

- A collective term referring to serum iron, ferritin and total iron binding capacity.

Wilson's Disease:

- Patients manifest clinical features of Kayser-Fleischer ring on ophthalmologic slit-lamp examination and one additional feature as follow: abnormal laboratory copper studies in consistent with Wilson's disease or abnormal liver function<sup>75</sup>.

### 3.4 Observation and Measurements

Demographic and clinical data of the patients were obtained from the medical records. Clinical information including clinical diagnosis of movement disorders, types and duration of abnormal movements, family history and current medications were recorded. For patients with PD, Hohn and Yahr score, duration of treatment and types of medication were also documented. (Appendix D)



For control subjects, after the informed consent was obtained, the healthy volunteers were required to fill in a health questionnaire. The questionnaire included information on age, gender, occupation, present medical conditions, current medications, history of exposure to heavy metals and presence of family history related to Wilson's disease and movement disorders (Appendix E).

After the collection of 3cc of clotted blood from each subject, the samples were immediately transported in room temperature to the laboratory of King Chulalongkorn Memorial Hospital within one hour. The laboratory technicians were instructed to process the samples on the same day. Laboratory measurements on serum samples included Cp, copper and GGT. Laboratory method for serum Cp measurement implemented the immunoturbidimetric assay with specific antiserum, COBAS INTEGRA® by Roche®.

### 3.5 Statistical Analysis

The serum level measurements were analyzed with SPSS program. Means, medians, standard deviations and confidence intervals were calculated. Student's unpaired t-test would be used for comparison of the means of Cp and the other measurements between patient and control groups. Subgroup analysis of serum level measurements of patients with different types of movement disorders was performed. ANOVA test was used to compare the means between different subgroups. Multiple regression analysis was used to assess factors that might have affected the serum levels of Cp. Null hypothesis would be rejected if the  $p$  values were  $\leq 0.05$ .

### 3.6 Ethical Considerations

All patients and volunteers will be provided information on this research study and informed consent will be sought for every subject. Whole blood of 4cc would be drawn from all subjects who take part in this study and it might produce minor discomfort or bruising at needle sites. Demographic data and medical information would be obtained from the medical records of patients only by personnel involved in this study.

This research study was approved by the Institutional Review Board of the Ethic Committee at the Faculty of Medicine, Chulalongkorn University on 25<sup>th</sup> September 2007 (Appendix A).



ศูนย์วิทยุทรัพยากร  
จุฬาลงกรณ์มหาวิทยาลัย

## CHAPTER 4

### RESULTS

#### 4.1 Demographic Data

There were 152 patients and 95 controls included in our study (Figure 16). Mean age was 58.9 years  $\pm$  14 in the patient group and 38.2 years  $\pm$  10.4 in the control group. Age was significantly higher in patient group when compared with controls ( $p < 0.001$ ). There were 82 (54%) female in the patient group and 53 (45%) female in the control group. There was no significant difference in gender distribution between the two groups ( $p = 0.2$ ). Median duration of abnormal movements in the patient group was 4 years, mean was 5.3 years  $\pm$  4.4 ranged from 1 month to 21 years (Table 5). Disease entities in patient group included: PD (85/152, 55%), essential tremor (ET) (17/152, 10%), primary focal dystonia (13/152, 9%), Parkinsonism-plus syndrome (13/152, 9%), tardive syndromes (11/152, 7%), vascular parkinsonism (6/152, 4%), Huntington's disease (3/152, 2%), familial myoclonus (2/152, 1%), post-infectious segmental myoclonus (1/152, 1%), late-onset sporadic cerebellar ataxia (1/152, 1%) and Tourette's syndrome (1/152, 1%)(Figure 17).

ศูนย์วิทยุทรัพยากร  
จุฬาลงกรณ์มหาวิทยาลัย

Figure 16: Total Number of Subjects Included in Our Study

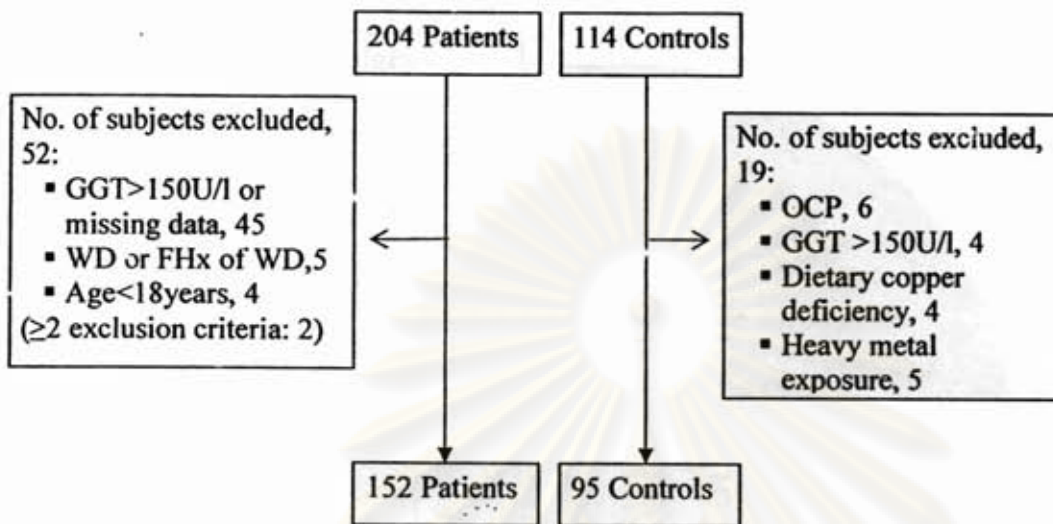
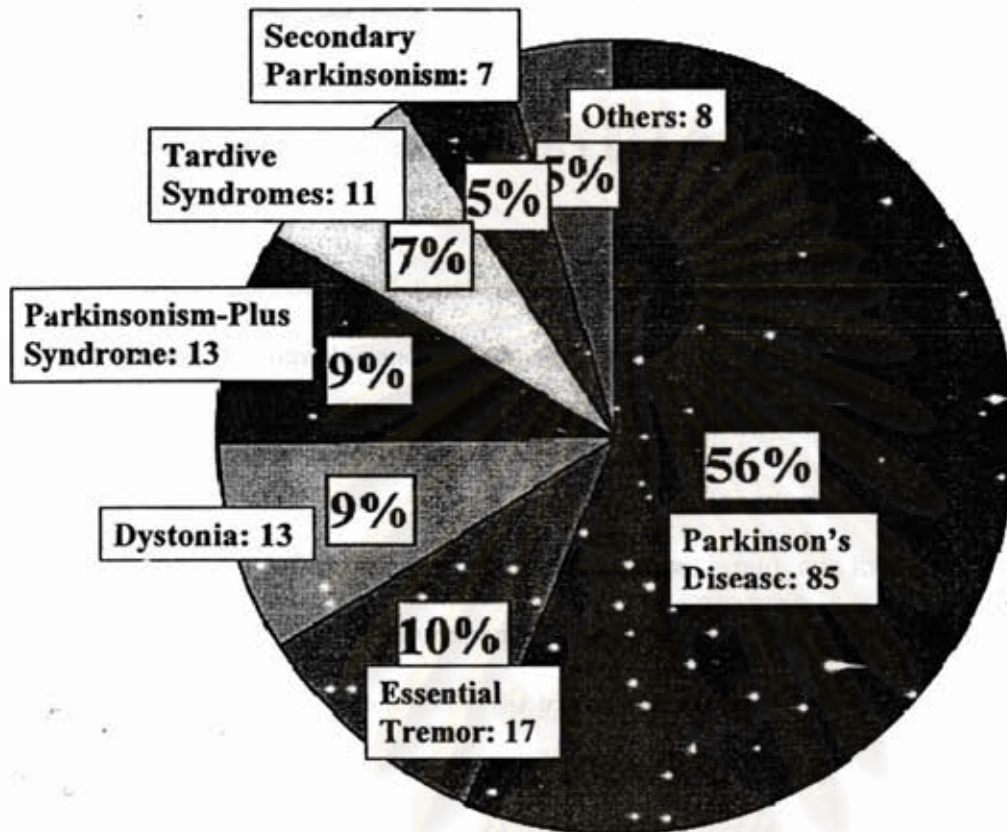

Table 5: Demographic Data of Patient and Control Groups

	Patients	Controls	<i>p</i> values
Total Number	152	95	-
Female (%)	54%	45%	0.2
Age (years)	58.9 ± 14	38.2 ± 10.4	< 0.001 *
GGT Levels	30.2 ± 23.7	31.8 ± 23.7	0.60
Symptom Duration (years)	Median: 4 Mean: 5.3 ± 4.4 Range: 0.1 - 21	-	-

\* *p* values < 0.001 were considered statistically significant

Figure 17: Diagnosis of Different Movement Disorders in Patient Group



#### 4.2 Analysis of Serum Ceruloplasmin Levels

The mean Cp level in the patient group was  $20.8\text{mg/dl} \pm 4.3$  (minimum: 13.03; maximum: 38.99). The mean was within the lower limit of laboratory reference value of  $20\text{mg/dl}$ . The mean Cp level in the control group was  $23.3\text{mg/dl} \pm 6.2$  (minimum: 14.10; maximum: 43.96). It was found that the mean Cp level in the patient group was significantly lower than controls ( $p < 0.001$ ) (Table 6).

Multiple regression analysis was performed on all our subjects to identify factors that might have affected the serum measurements of Cp (Table 3). The following formula was generated:

$$[Cp] = 22.431 - 2.441 * \text{movement disorders} + 2.568 * \text{female} + 0.069 * [GGT]$$

- *movement disorders*: 1 = patient group; 0 = healthy control
- *female*: 1 = female gender; 0 = male gender
- *GGT*: serum levels of GGT

The presence of movement disorders, i.e. patient group, was found to negatively affect the serum measurements of Cp ( $r = -0.24$ ). It was consistent with the finding of the lower mean Cp levels in the patient group when compared with controls. The levels of GGT was found to positively correlate with Cp levels ( $r = 0.25$ ). Female gender was a factor that could increase the serum measurements of Cp ( $r = 0.09$ ). Comparison between the demographic data in both patient and control groups did not show any difference in the mean GGT levels and the gender distribution (Table 1). Therefore, GGT levels and gender distribution did not confound the finding of a lower mean Cp levels in the patient group. The levels of total copper is probably positively correlated with serum Cp measurements ( $p=0.07$ ). It is known that about 90% of copper in our body is bound to Cp, so the levels of Cp and copper are likely to be positively correlated with one another<sup>76</sup>.

According to the regression analysis, age did not affect serum levels of Cp ( $p=0.12$ ) (Table 7). This finding was important to confirm that the factor of older age was not a confounder for the lower mean Cp level found in our patient group.

Other factors included in the analysis were: symptom duration, Hohn & Yahr staging and types of medications, e.g. dopamine agonist, levodopa (for patients with PD). These factors were not found to affect the serum Cp levels ( $p > 0.05$ ).

Table 6: Serum Measurements in Both Patient and Control Groups

	Patients	Controls	P values
Ceruloplasmin (20-60mg/dl)	20.8 ± 4.3	23.3 ± 6.2	< 0.001 *
Copper (0.7-1.4µg/ml)	1.2 ± 1.5	1.1 ± 0.3	0.23
GGT (1-94U/l)	30.2 ± 23.7	31.8 ± 23.7	0.6

\*  $p$  values < 0.001 and †  $p$  values < 0.05 were considered statistically significant

ศูนย์วิทยุทรัพยากร  
จุฬาลงกรณ์มหาวิทยาลัย

Table 7: Factors Identified by Multiple Regression Analysis to Affect Serum Measurements of Ceruloplasmin

Factors	Correlation Coefficients	<i>p</i> values
Movement Disorders	-0.24	< 0.001 *
GGT Levels	0.25	< 0.001 *
Female Gender	0.09	< 0.001 *
Copper Levels	-	0.07
Age	-	0.124

\* *p* values < 0.001 were considered statistically significant

#### 4.3 Analysis of other Serum Measurements

The mean levels of copper, iron, TIBC, ferritin and GGT in both the patient and control groups were all within the normal laboratory reference range (Table 6). There were no significant difference in the mean values of copper, iron, TIBC and GGT between the patient and control groups ( $p > 0.05$ ). Mean ferritin level in the patient group was significantly higher than the control group ( $p = 0.01$ ). Correlation analysis was performed. A positive correlation between ferritin level and age was found ( $p = 0.03$ ), indicating the higher mean ferritin level among our patients was confounded by their older age when compared with controls (Figure 18).

Correlation analysis was performed among other parameters measured. Serum iron was positively correlated with TIBC,  $r = 0.58$  ( $p < 0.001$ ).



Figure 18: Positive Correlation between Ferritin Levels and Age

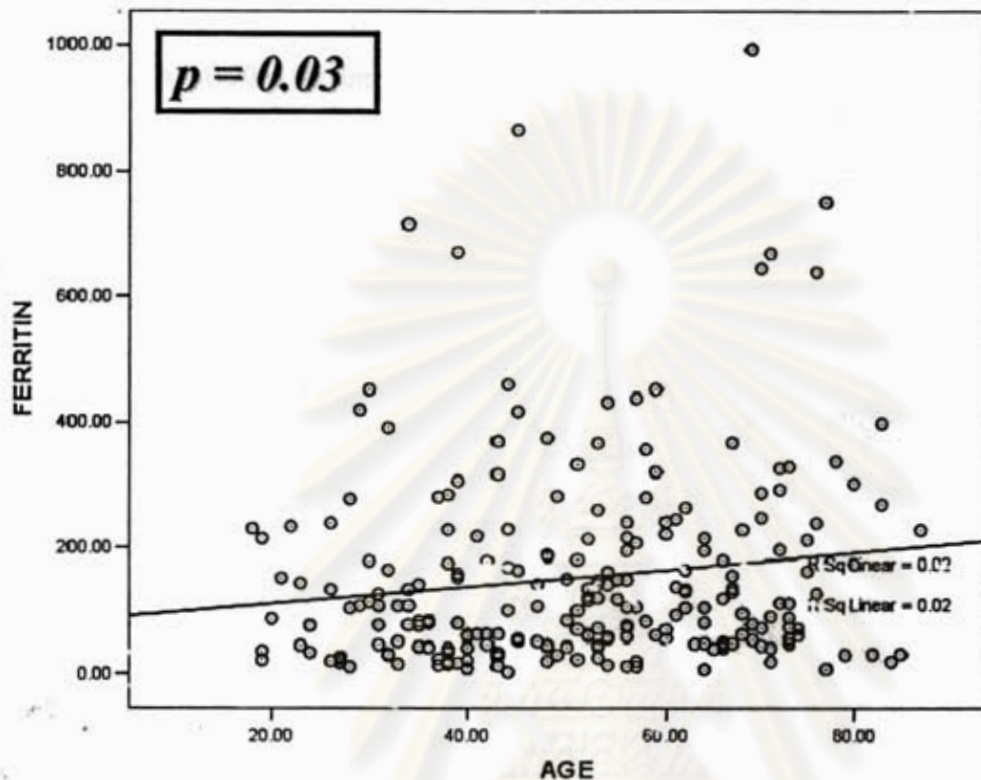

#### 4.4 Subgroup Analysis of Serum Ceruloplasmin Measurements in Different Movement Disorders

Subgroup analysis of the serum Cp measurements between different movement disorders was performed. Mean Cp levels in PD and ET were 20.2mg/dl and 20.6mg/dl respectively and they were both significantly lower than the mean Cp level of 23.3mg/dl ( $p < 0.001$  and  $p = 0.04$ ) (Figure 19). There was no difference between the mean Cp levels of patients with other disease entities when compared with the control group. There were 45 out of 85 patients (53%) with PD who had a Cp levels below the lower limit of laboratory reference range of 20mg/dl (Figure 20).

When the patient group was subdivided according to the underlying etiologies, subgroup analysis indicated that the mean Cp levels of neurodegenerative movement disorders (20.4mg/dl) was significantly lower when compared with the control group (23.3mg/dl) ( $p < 0.001$ ) (Figure 21). The mean Cp levels of other etiologies, i.e. idiopathic movement disorders, drug-induced movement disorders and vascular movement disorders, were not different from controls ( $p > 0.05$ ).

Figure 19: Mean Ceruloplasmin Levels in Parkinson's Disease and Essential Tremor were Significantly Lower than Controls

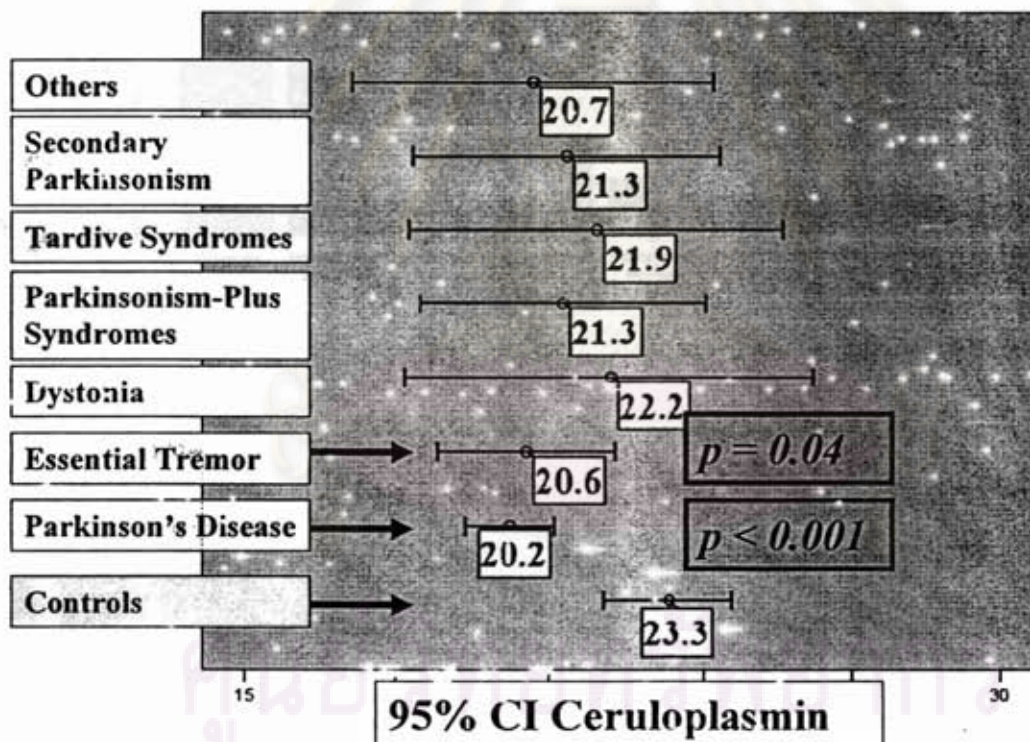
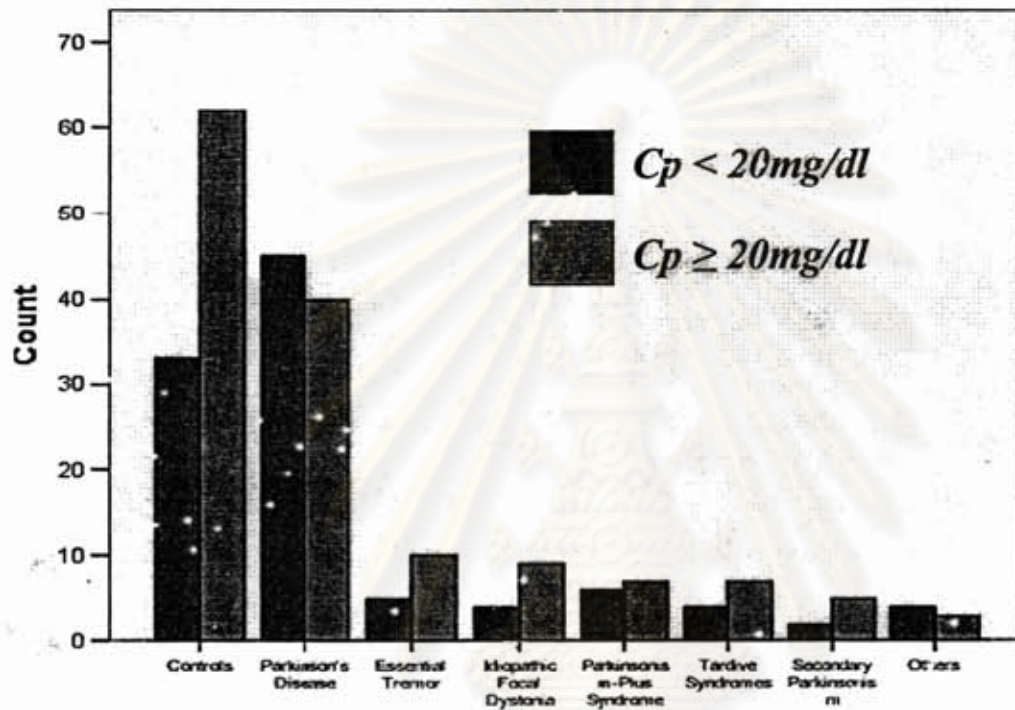
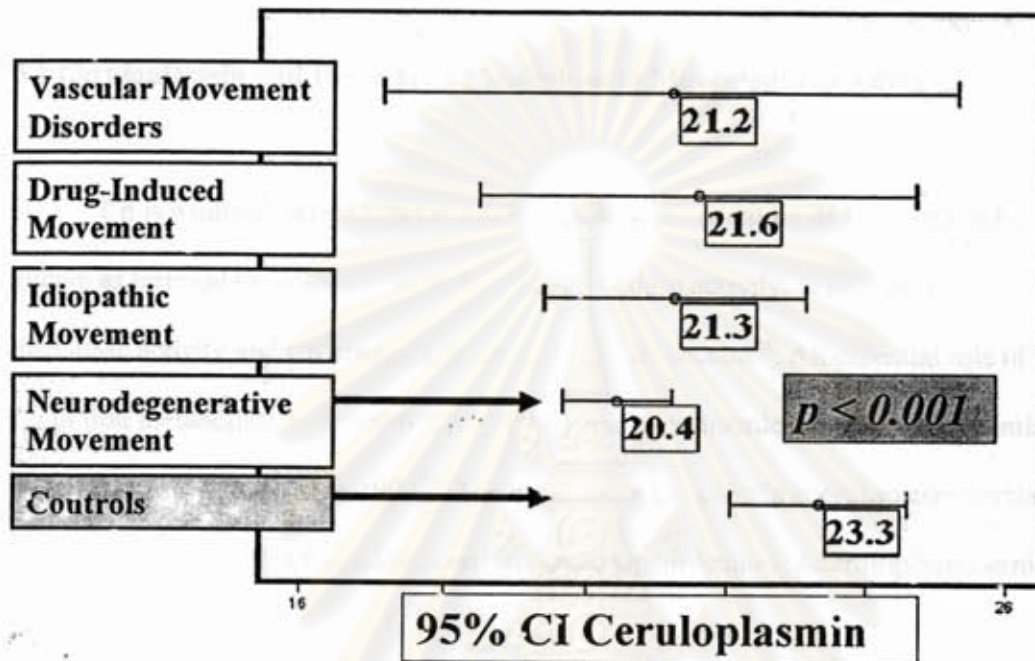

Figure 20: Proportion of Patients with Ceruloplasmin Levels below the Lower Limit of Normal Laboratory Reference Range of 20mg/dl. Over 50% of Patients with Parkinson's Disease had Ceruloplasmin Levels below 20mg/dl.



ศูนย์วิทยุทรัพยากร  
จุฬาลงกรณ์มหาวิทยาลัย

Figure 21: Mean Ceruloplasmin Level in Neurodegenerative Movement Disorders was Significantly Lower than Controls



ศูนย์วิทยทรัพยากร  
จุฬาลงกรณ์มหาวิทยาลัย

## CHAPTER 5

### DISCUSSIONS

#### 5.1 Ceruloplasmin and Brain Iron Metabolism in Movement Disorders

Cp is a multifunctional protein. Its roles include oxidation of toxic iron (also known as ferroxidase activity), copper-binding, oxidase activity, superoxide dismutase activity and Cp also acts as an acute phase reactant<sup>25</sup>. An essential role of Cp in iron metabolism was highlighted in the hereditary disorder aceruloplasminemia, which was first described in 1994<sup>77</sup>. The mutation of Cp gene in aceruloplasminemia results in the synthesis of dysfunctional truncated Cp molecules. Aceruloplasminemia is associated with excessive iron accumulation and iron-mediated toxicity in the brain with the onset of symptoms between the ages of 40 and 50 years<sup>53</sup>. Patients develop neurological abnormalities such as hyperkinetic movements, parkinsonism, cerebellar ataxia, dementia, and other systemic involvements including late-onset diabetes.

In Wilson's disease, low serum Cp levels are associated with neurological manifestations, commonly tremor, parkinsonism and dystonia. Neurological damage is a result of copper and iron depositions in the brain which can be seen in brain MRI. Small number of patients was found to have iron overload in their livers<sup>78</sup>.

PD is one of the most common neurodegenerative movement disorders. Increased echogenicity of the substantia nigra on transcranial ultrasound can be found in about 90% of PD patients, indicating iron accumulation<sup>61, 62</sup>. The detection of sequence variations in Cp gene in a PD patient<sup>1</sup> and the presence of Cp

immunoreactivity in Lewy bodies<sup>1</sup> were the first hints that Cp might have a suspected role in the pathogenesis of PD. Furthermore, PD patients with Cp missense mutations were found to have reduced serum Cp levels and ferroxidase activity<sup>2</sup>. Thus, reduced Cp levels, insufficient ferroxidase activity, excessive regional brain iron are all thought to be involved in the cascade of neurodegeneration in PD<sup>79</sup>. It is not known whether the involvement of Cp is a primary or secondary phenomenon.

## 5.2 Reduced Serum Ceruloplasmin levels in Non-Wilsonian Movement Disorders

In this study, the serum Cp measurements were on average significantly lower in the patient group than in the control group. In a retrospective study by Walshe, serum Cp levels were found to be less than the lower limit of normal range in almost half of the patients with non-Wilsonian movement disorders<sup>3</sup>. The mean Cp level of all patients with non-Wilsonian movement disorders was 22.9mg/dl, which was slightly higher than the mean serum Cp level of 20.8mg/dl in our patient group.

Our subgroup analysis revealed that serum Cp levels on average were lower in patients with PD and ET when compared to the control group. Torsdottir et al reported that the serum measurements and oxidative activity of Cp in 40 patients with PD were on average lower than their age- and gender-matched controls<sup>80</sup>. The authors proposed that old age, long disease duration and long term use of levodopa and decarboxylase inhibitor might be factors contributing to lower serum Cp levels in these patients<sup>64, 80</sup>. However, these factors were not shown to significantly affect the serum Cp levels among our patients with PD.

### 5.3 Possible Mechanisms of Low Serum Ceruloplasmin Levels in Different Movement Disorders

Our patient group encompassed a spectrum of movement disorders with different underlying etiologies. Thus, the finding of a lower serum Cp level in our patient group might imply two possibilities: 1) serum Cp level is lower in patients with different types of movement disorders when compared to controls, suggesting either a final common pathway leading to basal ganglia circuit dysfunction or an outcome phenomenon resulting from basal ganglia dysfunction, and 2) serum Cp level is lower in certain subgroups of movement disorders when compared to controls, which is in concordance with the finding in our subgroup analysis. These possibilities are further discussed below.

Our subgroup analysis revealed selective reductions of serum Cp levels in patients with PD, ET, and among patients with neurodegenerative movement disorders as a whole. According to published data, it is plausible that the dysfunction of Cp is associated with toxic iron overload and neurotoxicity in neurodegenerative movement disorders such as PD<sup>61, 79, 81</sup>. Our findings were also in line with other previous studies on low serum Cp measurements of patients with PD when compared with healthy controls<sup>65, 80</sup>. It remains uncertain whether the role of Cp is a primary cause or a secondary phenomenon in the cascade of neuronal damage, or whether a low Cp level in the serum is a phenomenon observed as a result of neuronal death. Hochstrasser et al proposed the possibilities of oxidative stress and aggregation of Cp molecules following disruption of neuronal function<sup>1, 2</sup> (Figure 22).

ET is a progressive movement disorder, in which the pathogenesis remains unclear. Recent studies report heterogeneous pathological findings in postmortem ET

brain. The majority of these 33 brains (76%) did not show Lewy bodies, however, demonstrated reduction in Purkinje cells in the cerebellum. The remaining proportion of ET brains revealed Lewy bodies in the brain stem, especially in the locus coeruleus. Taking into account of the prolonged course and progressive nature and the pathological finding of Lewy bodies in subgroup of postmortem ET brain, it is still controversially debatable whether the ET-Lewy body subgroup would be considered neurodegenerative in nature. Further studies might provide us an answer in the near future. In view of our findings, it might be possible that low Cp levels are associated with certain movement disorders, in which an ongoing disease course is expected.

Nevertheless, one should be cautious in the interpretation of the result of subgroup analysis. It is because this study was not powered to study each individual subgroup. The significant difference in the means Cp levels in both PD and ET groups might merely reflect the larger sample size in these two subgroups. The same argument might apply to the finding of a decreased mean Cp level in the subgroup analysis of neurodegenerative disorders when compared with controls.

#### **5.4 Elimination of Confounding Factors**

We conducted a linear regression analysis to ensure any possible confounding factors for our findings were accounted for. Female gender and GGT level were factors shown to affect serum Cp measurements among our studied subjects. Gender distribution was similar in both of our patient and control groups. And, no difference in the mean GGT levels was found between the two groups. GGT was reported to be a sensitive index of liver disease, but it is non-specific for the cause of the liver disease<sup>82</sup>. GGT was used as a marker for liver disease in our patients and controls.



Liver diseases can either increase or decrease the serum measurements of Cp, depending on the underlying causes. Therefore, subjects with raised GGT level were excluded from our statistical analysis. Female hormone is known to increase serum Cp level<sup>83</sup>, so we also excluded subjects who were taking oral contraceptive pills and hormone replacement therapy.

Since there was a difference in mean age between our patients and controls, it was essential to confirm that age did not affect the level of serum Cp in the linear regression analysis. Similar findings in previous study also reported that age did not significantly affect the serum Cp levels in adults<sup>66, 83</sup>. Nevertheless, it is known that serum Cp levels are slightly higher in young children<sup>66</sup>. Musci et al showed that serum Cp molecules underwent conformational changes with age but its oxidative activity is retained in healthy individuals<sup>66</sup>.

Copper incorporation into the Cp molecule is an important step in the synthesis of Cp. In Wilson's disease, the failure of copper binding to Cp molecule leads to excessive copper and reduced *holo*-ceruloplasmin level<sup>84</sup>. In Menke's disease, severe copper deficiency is associated with reduced *holo*-ceruloplasmin synthesis<sup>77</sup>. Thus, copper concentration is directly associated with serum Cp measurements<sup>85, 86</sup>. Subjects with severe copper deficiency were excluded from our statistical analysis, and it was worth noting that there was no difference in the mean copper levels between our patient and control groups.

Heterozygotes for Wilson's disease can have reduced serum Cp measurements<sup>84</sup>. While it is certainly a possibility in both of our patient and control groups, this factor is very unlikely to have confounded the outcome of our analysis.

Figure 22: Proposed Mechanisms of the Involvements of Ceruloplasmin in Different Movement Disorders. It is Uncertain whether the Role of Ceruloplasmin is a Causal Factor or an Outcome Event in the Cascade.

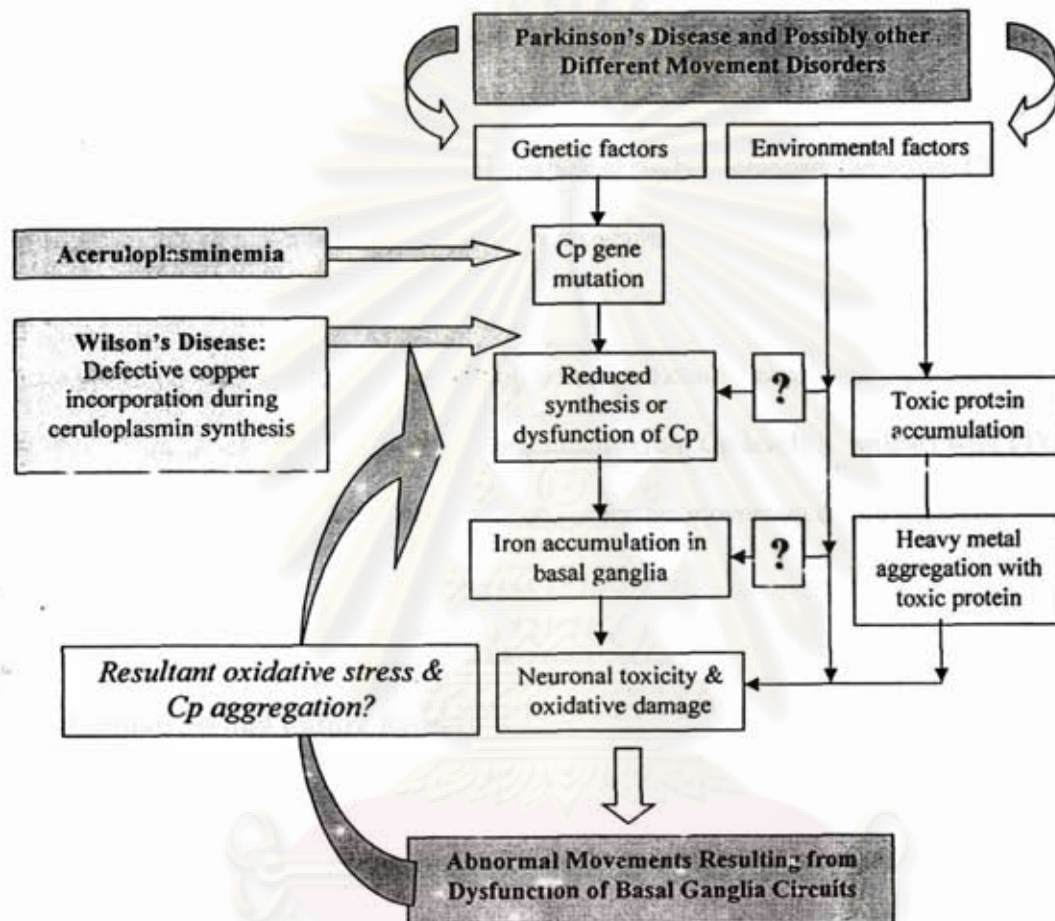

ศูนย์วิทยทรัพยากร  
จุฬาลงกรณ์มหาวิทยาลัย

## CHAPTER 6

### CONCLUSIONS

#### 6.1 Summary of Findings

We conducted a cross-sectional analytical study to compare the serum Cp measurements of patients who attended our movement disorders clinic with healthy controls. There were 152 patients and 95 controls included in our statistical analysis. Mean serum Cp level in the patient group was significantly lower than the control group. Subgroup analysis showed reduced mean serum Cp levels in patients with PD, ET and in patients with underlying neurodegenerative movement disorders, when compared with controls.

#### 6.2 Limitations and Future Research

Movement disorder encompassed a large spectrum of disease entities of different etiologies. Therefore, our study group represented a heterogeneous group of patients. However, since this is a pilot study of this kind, results from this study are helpful to direct future studies, which might focus on certain movement subgroups. Indeed, this is the first systemic prospective analytical study showing that mean serum Cp level is lower in patients with movement disorders when compared with controls. The inclusion of patients with different abnormal movements also helped to increase the sample size and interesting trends of differential decreased in mean Cp level were also observed in the subgroup analysis as a result.

The lack of age-match and gender-match control group was an important limitation of this study. Future study with age-range-match and gender-match control group can increase the validity of the study finding. An addition of control group incorporating age-match and gender-match neurological patients without abnormal movements might further help to elucidate the association of serum Cp level and movement disorders. A research design of longitudinal cohort study, which the control and study groups are followed over a period of time and serum measurements are obtained at different time point would be an ideal design for future study. However, due to the prolonged period of time required for cohort study and the high chance of loss-of-follow-up, the implementation of case-control study is still feasible. These research designs would also allow extra information regarding the correlation of serum Cp levels and disease progression, disease duration and treatment effect to be obtained. Basic scientific research on GPI-Cp in the CNS and its association with systemic Cp would improve our understanding on the potential role of Cp in various neurological disorders.

Total serum copper levels are subjected to variation with dietary copper intake. Diurnal variation in ferritin level has been observed in certain movement disorders, e.g. restless leg syndrome. Therefore, an early morning sample of serum following overnight fasting would be preferable in future studies. Furthermore, there is no standardized method of measuring serum Cp level available at present, the reliability and precision of Cp measurement should be analyzed in each laboratory. Reference range for gender should be available. These independent data was not available in the department of laboratory medicine. Nevertheless, validity studies on COBAS INTEGRA<sup>®</sup> analyzer to analyze reproducibility and method comparison

were obtained directly from Roche® instead for the purpose of study (data listed in literature review section).

#### 6.4 Research Benefits and Applications

In clinical practice, the measurements of serum Cp are mostly limited to the screening for Wilson's disease. The findings of this study showed that patients with other different movement disorders can also have serum Cp levels below the lower limit of the normal reference range. The awareness of this possibility is important to avoid the risk of overlooking other potential diagnosis besides Wilson's disease in patients with abnormal movements and low Cp levels. Nevertheless, in our movement disorders clinic, we have observed that patients with symptomatic Wilson's disease often have a very low serum Cp level in single digit (i.e. <10mg/dl), often more than 50% below the lower limit of normal reference range. Serum Cp levels in asymptomatic homozygote sibling of patients with Wilson's disease, their serum Cp levels are usually just slightly above 10mg/dl, which is much lower than the mean Cp levels in our patients group of 20.8mg/dl. Previous studies have reported rare neurological entities with combinations of abnormal movements, dysarthria and hyperintense T2-weighted signal in basal ganglia that were associated with reduced serum level of Cp of approximately 15mg/dl<sup>87</sup>.

In view of our findings, we propose that the measurement of serum Cp should be considered as part of the investigation panel in the approach of patients with abnormal movements. The different ranges of serum Cp levels can help in the differential diagnosis of various disease entities as mentioned above, though further studies would be required to consolidate our existing data (see figure 23).

Furthermore, a low serum Cp measurement might potentially suggest an ongoing underlying disease process, as opposed to static events, such as vascular parkinsonism.

If future studies confirm the relationship between Cp, heavy metals and non-Wilsonian movement disorders, metal chelators can be considered as therapeutic options in selective disease entities.

Figure 23: Diagram to Illustrate Different Ranges of Ceruloplasmin Levels in Various Movement Disorders (approximate values are shown).

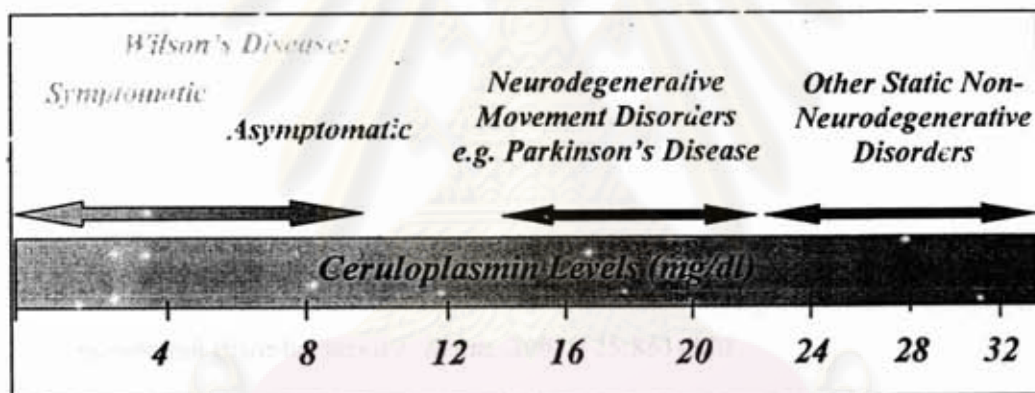

ศูนย์วิทยุทรัพยากร  
จุฬาลงกรณ์มหาวิทยาลัย

## REFERENCES

- [1.] Hochstrasser H, Bauer P, Walter U et al. Ceruloplasmin gene variations and substantia nigra hyperechogenicity in Parkinson disease. *Neurology*. 2004;63:1912-1917
- [2.] Hochstrasser H, Tomiuk J, Walter U et al. Functional relevance of ceruloplasmin mutations in Parkinson's disease. *Faseb J*. 2005;19:1851-1853
- [3.] Walshe JM. Diagnostic significance of reduced serum caeruloplasmin concentration in neurological disease. *Mov Disord*. 2005;20:1658-1661
- [4.] Gershanik O. Parkinson's disease. In: Tolosa E, Koller W, Gershanik O, eds. *Differential diagnosis and treatment of movement disorders*. Newton: Butterworth-Heinemann, 1998:7
- [5.] Piccini P, Brooks D. New developments of brain imaging for Parkinson's disease and related disorders. *Mov Disord*. 2006;21:2035-2041
- [6.] Hughes A. The accuracy of diagnosis of parkinsonian syndromes in a specialist movement disorder service. *Brain*. 2002;125:861-880
- [7.] Polymeropoulos MH, Lavedan C, Leroy E et al. Mutation in the alpha-synuclein gene identified in families with Parkinson's disease. *Science*. 1997;276:2045-2047
- [8.] Flaherty A, Graybeal A. Anatomy of the basal ganglia. In: Marsden C, Fahn S, eds. *Movement Disorders*. Vol. 3. Oxford: Butterworth-Heinemann, 1994
- [9.] Holmberg C. On the presence of a lacase-like enzyme in serum and its relation to the copper in serum. *Acta Physiol Scand*. 1944;8:227-229

- [10.] Holmberg C, Laurell C. Investigations in serum copper II, isolation of the copper-contracting protein and a description of some of its properties. *Acta Chem Scand.* 1948;2:550-556
- [11.] Scheinberg I, Gitlin D. Deficiency of ceruloplasmin in patients with hepatolenticular degeneration *Science.* 1952;116:484-489
- [12.] Barrass C, Coult D. Interaction of some centrally active drugs with ceruloplasmin. *Biochem Pharmacol.* 1972;21:677-685
- [13.] Barrass C, Coult D, Pinder R. 3-Hydroxy-4-methoxyphenethylamine: the endogenous toxin of parkinsonism? . *J Pharm Pharmacol.* 1973;24:2891-2895
- [14.] Klomp L, Gitlin J. Expression of the ceruloplasmin gene in the human retina and brain: implications for a pathogenic model in aceruloplasminemia. *Hum Mol Genet.* 1996;5:1989-1996
- [15.] Patel BN, David S. A novel glycosylphosphatidylinositol-anchored form of ceruloplasmin is expressed by mammalian astrocytes. *J Biol Chem.* 1997;272:20185-20190
- [16.] Patel BN, Dunn RJ, Jeong SY et al. Ceruloplasmin regulates iron levels in the CNS and prevents free radical injury. *J Neurosci.* 2002;22:6578-6586
- [17.] Castellani R, Smith M, Nunomura A. Is increased redox-active iron in Alzheimer disease a failure of the copper-binding protein ceruloplasmin? *Free Radical Biol Med.* 1999;26:1508-1512
- [18.] Kaneko K, Yoshida K, Arima K. Astrocytic deformity and globular structures are characteristic of the brains of patients with aceruloplasminemia. *J Neuropathol Exp Neurol.* 2002;61:1069-1077
- [19.] Loeffler D, Sima A, LeWitt P. Ceruloplasmin immunoreactivity in neurodegenerative disorders. *Free Radical Res.* 2001;35:111-118



- [20.] Loeffler DA, LeWitt PA, Juneau PL et al. Increased regional brain concentrations of ceruloplasmin in neurodegenerative disorders. *Brain Res.* 1996;738:265-274
- [21.] Daimon M, Yamatani K, Igarashi M. Fine structure of the human ceruloplasmin gene. *Biochem Biophys Res Commun.* 1995;208:1028-1035
- [22.] Jeong S, David S. Glycosylphosphatidylinositol-anchored ceruloplasmin is required for iron efflux from cells in the central nervous system. *J Biol Chem.* 2003;278:27144-27148
- [23.] Malmstrom B. Early and more recent history in the research on multi-copper oxidases. In: Messerschmidt A, ed. *Multi-copper oxidases*. Singapore: World Scientific, 1997:1-22
- [24.] Vachette P, Dainese E, Vasyliev V. A key structural role for active site type 3 copper ions in human ceruloplasmin. *J Biol Chem.* 2002;277:40823-40831
- [25.] Healy J, Tipton K. Ceruloplasmin and what it might do. *J Neural Transm.* 2007;114:777-781
- [26.] Osaki S, Johnson D, Frieden E. The mobilization of iron from the perfused mammalian liver by a serum copper enzyme, ferroxidase. *J Biol Chem.* 1971;246:3018-3023
- [27.] Squitti R, Pasqaletti P, Dal Forno G et al. Excess of serum copper not related to ceruloplasmin in Alzheimer disease. *Neurology.* 2005;64:1040-1046
- [28.] Anderson G, Vulpe C. Regulation of intestinal iron transport. In: Templeton D, ed. *Molecular and cellular iron transport*. New York: Marcel Dekker, 2001:559-596
- [29.] Meyer L, Durley A, Prohaska J. Copper transport and metabolism are normal in aceruloplasminemic mice. *J Biol Chem.* 2001;276:36857-36861

- [30.] Mukhopadhyay C, Attieh Z. Role of ceruloplasmin in cellular iron uptake. *Science*. 1998;279:714-717
- [31.] Musci G, Bonaccorsi di Patti M, Calabrese L. Modulation of the redox state of the copper sites of human ceruloplasmin by chloride. *J Protein Chem*. 1995;14:611-619
- [32.] Medda R, Calabrese L, Musci G. Effect of ceruloplasmin on 6-hydroxydopamine oxidation. *Biochem Mol Biol Int*. 1996;38:721-728
- [33.] Cohen G, Heikkila R. The generation of hydrogen peroxide, superoxide radical, and hydroxyl radical by 6-hydroxydopamine, dialuric acid, and related cytotoxic agents. *J Biol Chem*. 1974;249:2447-2452
- [34.] Floris G, Medda R, Padiglia A. The physiopathological significance of ceruloplasmin. *Biochem Pharmacol*. 2000;60:1735-1741
- [35.] Klomp L, Gitlin D. Biochemical characterization and subcellular localization of human copper transporter 1. *Biochem J*. 2002;364:497-505
- [36.] Zhou B, Gitschier J. hCTR1: a human gene for copper uptake identified by complementation in yeast. *Proc Natl Acad Sci*. 1997;7481-7486
- [37.] Sato M, Gitlin D. Mechanisms of copper incorporation during the biosynthesis of human ceruloplasmin. *J Biol Chem*. 1989;266:5128-5134
- [38.] H S, ZL H. Genetic defects in copper metabolism. *J Nutr*. 2003;1527S-1531S
- [39.] Adachi Y, Okuyama Y, Miya H. Presence of ATP-dependent copper transport in the hepatocyte canalicular membrane of the Long-Evans cinnamon rat, an animal model of Wilson disease. *J Hepatol*. 1987;26:216-217
- [40.] El-Youssef M. Wilson Disease. *Mayo Clin Proc*. 2003;78:1126-1136
- [41.] Willeit J, Kiccl S. Wilson's disease with neurological impairment but no Kayser-Fleischer rings [letter]. *Lancet*. 1991;337:1426

- [42.] Topaloglu H, Gucuyener K, Orkun C. Tremor of tongue and dysarthria as the sole manifestation of Wilson's disease. *J Neurol Neurosurg Psychiatry*. 1990;92:295-296
- [43.] Kayser B. Ueber einen Fall von angeborener grunlicher Verfärbung der Kornea. *Klin Monatsbl Augenheilkd*. 1902;40:22-25
- [44.] Wilson S. Progressive lenticular degeneration: a familial nervous disease associated with cirrhosis of the liver. *Brain*. 1912;34:295-364
- [45.] Gow P, Smallwood R, PWA. Diagnosis of Wilson's disease: an experience over three decades. *Gut*. 2000;46:415-419
- [46.] Bowcock A, Farrer L, Cavalli-Sforza L. Mapping the Wilson disease locus to a cluster of linked polymorphic markers on chromosome 13. *Am J Hum Genet*. 1987;41:27-35
- [47.] Riordan S, Williams R. The Wilson's disease gene and phenotypic diversity. *J Hepatol*. 2001;34:165-171
- [48.] Petrukhin K, Fischer S, Pirastu M. Mapping, cloning and genetic characterization of the region containing the Wilson disease gene. *Nat Genet*. 1993;5:338-343
- [49.] Perman J, Werlin S, Grand R. Laboratory measures of copper metabolism in the differentiation of chronic active hepatitis and Wilson disease in children. *J Pediatr*. 1979;94:564-568
- [50.] Walshe J, Yealland M. Wilson's disease: the problem of delayed diagnosis. *J Neurol Neurosurg Psychiatry*. 1992;55:692-696
- [51.] Berg D, Hochstrasser H, Schweitzer KJ, Riess O. Disturbance of iron metabolism in Parkinson's disease -- ultrasonography as a biomarker. *Neurotox Res*. 2006;9:1-13

- [52.] Berg D, Hochstrasser H. Iron Metabolism in Parkinsonian Syndromes. *Mov Disord.* 2006;21:1299-1310
- [53.] Xu X, Pin S, Gathinji M et al. Aceruloplasminemia: an inherited neurodegenerative disease with impairment of iron homeostasis. *Ann NY Acad Sci.* 2004;1012:299-305
- [54.] Hellman N, Kono S, Miyajima H, Gitlin J. Biochemical analysis of a missense mutation in aceruloplasminemia. *J Biol Chem.* 2002;277:1375-1380
- [55.] Curtis AR, Fey C, Morris CM et al. Mutation in the gene encoding ferritin light polypeptide causes dominant adult-onset basal ganglia disease. *Nat Genet.* 2001;28:350-354
- [56.] Mancusco M, Davidzon G, Kurlan R. Hereditary ferritinopathy: a novel mutation, its cellular pathology, and pathogenetic insights. *J Neuropathol Exp Neurol.* 2005;64:280-294
- [57.] Vidal R, Ghetti B, Takao M. Hereditary ferritinopathy. *J Neurol Sci.* 2003;207:110-111
- [58.] Hayflick SJ, Westaway SK, Levinson B et al. Genetic, clinical, and radiographic delineation of Hallervorden-Spatz syndrome. *N Engl J Med.* 2003;348:33-40
- [59.] Zhou B, Westaway S, B L. A novel pantothenate kinase gene (PANK2) is defective in Hallervorden-Spatz syndrome. *Nat Genet.* 2001;28:345-349
- [60.] Menkes J. A sex-linked recessive disorder with retardation of growth, peculiar hair, and focal cerebral and cerebellar degeneration. *Pediatrics.* 1962;50:764-769
- [61.] Berg D, Gerlach M, Youdim MB et al. Brain iron pathways and their relevance to Parkinson's disease. *J Neurochem.* 2001;79:225-236

- [62.] Oakley AE, Collingwood JF, Dobson J et al. Individual dopaminergic neurons show raised iron levels in Parkinson disease. *Neurology*. 2007;68:1820-1825
- [63.] LaVaute T, Smith S, Cooperman S. Targeted deletion of the gene encoding iron regulatory protein-2 causes misregulation of iron metabolism and neurodegenerative disease in mice. *Nat Genet*. 2001;27:209-214
- [64.] Torsdottir G, Kristinsson J, Gudmundsson G et al. Copper, ceruloplasmin and superoxide dismutase (SOD) in amyotrophic lateral sclerosis. *Pharmacol Toxicol*. 2000;87:126-130
- [65.] Torsdottir G, Sveinbjornsdottir S, Kristinsson J et al. Ceruloplasmin and superoxide dismutase (SOD1) in Parkinson's disease: a follow-up study. *J Neurol Sci*. 2006;241:53-58
- [66.] Musci G, Bonaccorsi di Patti M, Fagiolo U, Calabrese L. Age-related changes in human ceruloplasmin. Evidence for oxidative modifications. *J Biol Chem*. 1993;268:13388-13395
- [67.] Geser F, Colosimo C, Wenning G. Multiple system atrophy. In: Beal M, Lang A, A L, eds. Neurodegenerative diseases. Cambridge: Cambridge University Press, 2005:623-662
- [68.] Dexter D, Jenner P, Schapira A, Marsden C. Alterations in levels of iron, ferritin, and other trace metals in neurodegenerative diseases affecting the basal ganglia. *Ann Neurol*. 1992;32:S94-S100
- [69.] Double K, Jellinger K, Zecca L. Iron, neuromelanin, and alpha-synuclein in the neuropathogenesis of Parkinson's disease. In: Zatta P, ed. Metal ions and neurodegenerative disorders. New York: World Scientific, 2003:343-364
- [70.] Bartzokis G, Cummings J, Perlman S. Increased basal ganglia iron levels in Huntington disease. *Arch Neurol*. 1999;14:275-281

- [71.] Hilditch-Maguire P, Trettel F, Passani L. Huntingtin: a iron regulated protein essential for normal nuclear and perinuclear organelles. *Hum Mol Genet.* 2000;9:2789-2797
- [72.] Bonilla E, Estevez J, Suarez H. Serum ferritin in Huntington's disease patients. *Neurosci Lett.* 1991;129:22-24
- [73.] Allen R, Earley C. The role of iron in restless legs syndrome. *Mov Disord.* 2007;22:S440-S448
- [74.] Louis E, Faust P, Vonsattel J. Neuropathological changes in essential tremor: 33 cases compared with 21 controls. *Brain.* 2007;130:3297-3307
- [75.] Ferenci P, Caca K, Loudianos G. Diagnosis and phenotypic classification of Wilson disease. *Liver International.* 2003;23:139-142
- [76.] Gubler C, Lahey M, Cartwright G, Wirtrobe M. Studies of copper metabolism. The transportation of copper in the blood. *J Clin Invest.* 1953;32:404-414
- [77.] Logan JJ, Harveyson KB, Wisdom GB et al. Hereditary caeruloplasmin deficiency, dementia and diabetes mellitus. *Qjm.* 1994;87:663-670
- [78.] Walshe J, Cox D. Effect of treatment of Wilson's disease on natural history of haemochromatosis. *Lancet.* 1998;352:112
- [79.] Ya K, Zhong M. Iron misregulation in the brain: a primary cause of neurodegenerative disorders. *Lancet.* 2003;2:246-253
- [80.] Torsdottir G, Kristinsson J, Sveinbjornsdottir S et al. Copper, ceruloplasmin, superoxide dismutase and iron parameters in Parkinson's disease. *Pharmacol Toxicol.* 1999;85:239-243
- [81.] Vassiliev V, Harris ZL, Zatta P. Ceruloplasmin in neurodegenerative diseases. *Brain Res Brain Res Rev.* 2005;49:633-640

- [82.] Giannini EG, Testa R, Savarino V. Liver enzyme alteration: a guide for clinicians. *Cmaj*. 2005;172:367-379
- [83.] Milne D, Johnson P. Assessment of copper status: effect of age and gender on reference ranges in healthy adults. *Clin Chem*. 1993;39:883-887
- [84.] Kitzberger R, Madl C, Ferenci P. Wilson disease. *Metab Brain Dis*. 2005;20:295-302
- [85.] Twomey P, Viljoen A, House I et al. Copper:caeruloplasmin ratio. *J Clin Pathol*. 2007;60:441-442
- [86.] Twomey P, Viljoen A, House I et al. Adjusting copper concentrations for caeruloplasmin levels in routine clinical practice. *J Clin Pathol*. 2006;59:867-872
- [87.] Tagawa A, Ono S, Shibata M et al. A new neurological entity manifesting as involuntary movements and dysarthria with possible abnormal copper metabolism. *J Neurol Neurosurg Psychiatry*. 2001;71:780-783

ศูนย์วิทยทรัพยากร  
จุฬาลงกรณ์มหาวิทยาลัย



**APPENDICES**

ศูนย์วิทยทรัพยากร  
จุฬาลงกรณ์มหาวิทยาลัย



## Appendix A

Approval by the Institutional Review Board of Ethic Committee of Faculty of Medicine, Chulalongkorn University (chapter 5.1)

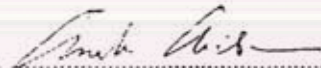
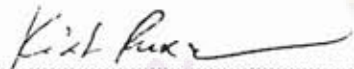
	
No. 658/2007 REC. No. 282/50	
<b>Certificate of Approval</b>	
<p>The Institutional Review Board of the Faculty of Medicine, Chulalongkorn University, Bangkok, Thailand, has approved the following study which is to be carried out in compliance with the ICH/GCP according to the protocol of the principal investigator</p> <p>The Institutional Review Board of the Faculty of Medicine, Chulalongkorn University reviewed the protocol based on the international guidelines for human research protection and ICH-GCP</p>	
<b>Study Title</b>	: Ceruloplasmin, Copper and Iron Parameters in Movement Disorder: implications of pathogenesis and diagnostic Significance.
<b>Study Code</b>	:
<b>Center</b>	: Chulalongkorn University
<b>Principal Investigator</b>	: Helen Ling, M.D.
<b>Document Reviewed</b>	:
	:  (Emeritus Professor Anek Aribarg, M.D.) Chairman of Institutional Review Board
	:  (Professor. Kiat Ruxrungtham, M.D.) Associate Dean for the Research Affairs With Representative of Dean
<b>Date of Approval</b>	: September 25, 2007
<b>Approval Expire Date</b>	: September 25, 2008
Approval is granted subject to the following conditions: (see back of this Certificate)	

## Appendix B

### Information Sheet and Consent Form for Both Patients and Healthy Volunteers (chapter 5.2)

#### ข้อมูลสำหรับผู้เข้ารับการศึกษาวินิจฉัยและหนังสือยินยอม

วันที่ : .....

ชื่อ-นามสกุล : .....

HN : .....

เบอร์โทรศัพท์ : .....

#### หัวข้อการวิจัย

การวิเคราะห์ระดับซีรูโลพลาสมีน ธาตุทองแดง และกลุ่มธาตุเหล็ก ในผู้ป่วยกลุ่มโรคความเคลื่อนไหวผิดปกติ เพื่อหาปัจจัยที่เกี่ยวข้องกับพยาธิสภาพ และความสำคัญในการวินิจฉัยโรค

#### แพทย์ผู้ทำการวิจัย

<p>พญ. เสนอ หลิง หน่วยประสาทวิทยา ภาควิชาอายุรศาสตร์ จุฬาลงกรณ์มหาวิทยาลัย เบอร์โทรศัพท์ 081-5031877</p>	<p>รองศาสตราจารย์นายแพทย์ รุ่งโรจน์ พิทยศิริ อาจารย์ที่ปรึกษาวิทยานิพนธ์ ภาควิชาอายุรศาสตร์ จุฬาลงกรณ์มหาวิทยาลัย</p>
<p>ฝ่ายวิจัยคณะแพทยศาสตร์ จุฬาลงกรณ์มหาวิทยาลัย อาคารอานันทมหิดล ชั้น 3 เบอร์โทรศัพท์ 0-2256-4454 / 0-2256-4493</p>	<p>ศาสตราจารย์นายแพทย์ กัมมันต์ พันธุ์จินดา อาจารย์ที่ปรึกษาวิทยานิพนธ์ (ร่วม) ภาควิชาอายุรศาสตร์ จุฬาลงกรณ์มหาวิทยาลัย</p>

#### 1. คำชี้แจงเกี่ยวกับการวิจัย

กลุ่มโรคความเคลื่อนไหวผิดปกติประกอบด้วยโรคต่างๆมากมาย เช่น โรคพาร์กินสัน โรคต้นแบบพันธุกรรม และโรคเกร็ง เป็นต้น โรคในกลุ่มความเคลื่อนไหวผิดปกติเช่นโรคพาร์กินสัน คือโรคการเสื่อมของระบบประสาทโดยมีปัจจัยจากพันธุกรรมและสิ่งแวดล้อมเป็นปัจจัยในการถูกทำลายของเส้นประสาทในสมองบางส่วน เช่น เซลล์ประสาทที่นำส่งสาร โดปามีน ในโรคพาร์กินสันซึ่งเป็นสาเหตุของการเกิดลักษณะอาการของโรค อย่างไรก็ตาม พยาธิสภาพและปัจจัยเสี่ยงของโรคจากการถูกทำลายของเส้นประสาทนั้นยังคงไม่ชัดเจน โรคการเสื่อมของระบบประสาทหลายโรคมักจะได้รับการวินิจฉัยจากอาการที่ปรากฏทางคลินิก หรือ ในบางกรณีต้องได้รับการตรวจเพิ่มเติมด้วยวิธีอื่นๆ เช่น การรังสีทางสมอง ในทางปฏิบัติ การตรวจเลือดมักไม่ค่อยจำเป็นในการวินิจฉัยของกลุ่มโรคนี้ ยกเว้นในบางโรคเช่น โรควิลสัน การได้รับสารพิษเข้าสู่ร่างกาย และโรคอื่นที่ไม่พบบ่อย

ซีรูโลพลาสมีน(Ceruloplasmin) เป็นเอนไซม์สังเคราะห์ของทองแดงในร่างกายของเรา ซีรูโลพลาสมีน มีหน้าที่สำคัญในกระบวนการเผาผลาญธาตุทองแดงและธาตุเหล็ก นอกจากนี้ซีรูโลพลาสมีน ยังมีหน้าที่หลักในการเป็นสารต่อต้านอนุมูลอิสระ ในการวิจัยในปัจจุบันพบว่าซีรูโลพลาสมีน อาจมีหน้าที่สำคัญ

ในการป้องกันการถูกทำลายของเส้นประสาทในระบบประสาทส่วนกลาง ในโรคการเสื่อมของระบบประสาท หลายโรคแสดงให้เห็นถึงระดับของซีรูโลพลาสมีน ในเลือดที่ลดลง เช่นเมื่อเปรียบเทียบระหว่างผู้ป่วยโรคพาร์กินสันและกลุ่มควบคุมที่มีสุขภาพแข็งแรง จากการวิจัย ซีรูโลพลาสมีน อาจมีหน้าที่เกี่ยวข้องกับพยาธิสภาพของโรค ในทางตรงหรือทางอ้อม ดังนั้น ค่าซีรูโลพลาสมีน ที่ผิดปกติสามารถเปลี่ยนแปลงระดับของธาตุทองแดงและธาตุเหล็กในเลือดได้ จึงเป็นผลจากกระบวนการเผาผลาญที่ผิดปกติ

## 2. วัตถุประสงค์ของการศึกษาวิจัย

วัตถุประสงค์ของการศึกษาวิจัยนี้คือ เพื่อวิเคราะห์หาระดับซีรูโลพลาสมีน(Ceruloplasmin) ธาตุทองแดง (Copper) ธาตุเหล็ก(Iron) เฟอร์ริทิน(Ferritin) ความสามารถในการจับตัวของธาตุเหล็ก (Total iron binding capacity) ในเลือดของผู้ป่วยที่เป็นโรคในกลุ่มความเคลื่อนไหวผิดปกติ เพื่อเปรียบเทียบกับอาสาสมัครที่ไม่เป็นโรคที่มีกลุ่มอายุและเพศเดียวกัน สารแกมมา กลูตามิว ทรานส์เปปติเดส (Gamma glutamyl transpeptidase, GGT) ใช้ในการประเมินการทำงานของตับ เนื่องจากการทำงานของตับที่ผิดปกติสามารถลดระดับซีรูโลพลาสมีนในเลือด

วัตถุประสงค์ในการศึกษาวิจัยมีดังต่อไปนี้

1. เพื่อวิเคราะห์และเปรียบเทียบระดับ ซีรูโลพลาสมีน ธาตุทองแดง และกลุ่มธาตุเหล็ก ในเลือดระหว่างผู้ป่วยโรคในกลุ่มความเคลื่อนไหวผิดปกติและอาสาสมัครที่มีสุขภาพแข็งแรง
2. เพื่อวิเคราะห์และเปรียบเทียบระดับซีรูโลพลาสมีน ธาตุทองแดง และกลุ่มธาตุเหล็ก ในเลือดระหว่างผู้ที่เป็นโรคการเสื่อมของระบบประสาทและผู้ที่เป็นโรคกลุ่มอื่นๆ
3. เพื่อศึกษาความสัมพันธ์ระหว่างระดับซีรูโลพลาสมีน และกลุ่มธาตุอื่นๆ ในเลือดเพื่อเพิ่มความเข้าใจในหน้าที่ของซีรูโลพลาสมีนในพยาธิสภาพและความสำคัญในการวินิจฉัยโรคกลุ่มการเคลื่อนไหวผิดปกติ

## 3. วิธีการวิจัย

ในการศึกษาวิจัยด้วยการอาสาสมัครที่เป็น โรคในกลุ่มการเคลื่อนไหวผิดปกติและอาสาสมัครที่มีสุขภาพแข็งแรง ในกลุ่มอายุเดียวกัน อาสาสมัครทุกท่านที่ตัดสินใจเข้าร่วมในโครงการศึกษาวิจัยจะได้รับการเจาะเลือดสำหรับการตรวจทางห้องปฏิบัติการจำนวน 1 ครั้ง ในปริมาณเลือด 4 CC.

การตรวจทางห้องปฏิบัติการมีดังนี้

1. ระดับซีรูโลพลาสมีน (Ceruloplasmin)
2. ระดับ ธาตุทองแดง (Copper)
3. ระดับ ธาตุเหล็ก (Iron)
4. ระดับเฟอร์ริทิน (Ferritin)
5. ความสามารถในการจับตัวของธาตุเหล็ก (Total iron binding capacity)
6. สารแกมมา กลูตามิว ทรานส์เปปติเดส (Gamma glutamyl transpeptidase, GGT)

การตรวจดังกล่าวข้างต้น ได้รับสนับสนุนจากกองทุนการวิจัย อาสาสมัคร ไม่ต้องเสียค่าใช้จ่ายใดๆทั้งสิ้น ในการตรวจเลือดนี้ ไม่มีกระบวนการพยาบาลอื่นๆ หรือการนำผลติดตามผลหลังจากการตรวจเลือด

ผลการตรวจเลือดจะถูกบันทึก วิเคราะห์ และหาความสัมพันธ์ระหว่างประวัติของผู้ป่วย การวินิจฉัยโรคและบันทึกทางการแพทย์โดยผู้ค้นคว้าวิจัย พยาบาลวิจัย และนักสถิติ

#### 4. ประโยชน์ที่ได้รับจากการวิจัย

อาสาสมัครจะไม่ได้รับค่าตอบแทนใดๆจากการเข้าร่วมโครงการวิจัย ผลเลือกจะถูกแจ้งให้อาสาสมัครทราบเมื่ออาสาสมัครต้องการทราบผลการตรวจเลือด หรือ เมื่อผลการตรวจเลือดผิดปกติที่อาจมีผลกระทบต่อการรักษาโรคของอาสาสมัคร

ผลการศึกษาวิจัยในครั้งนี้จะเป็นประโยชน์ต่อผู้ป่วยในอนาคต โดยการเพิ่มความเข้าใจในหน้าที่ของจีโนมพลาสติก ชาติทองแดง ชาติเหล็ก ในพยาธิสภาพในกลุ่มโรคความเคลื่อนไหวผิดปกติ ผลการของวิจัยในครั้งนี้จะช่วยแพทย์วิเคราะห์ประโยชน์จากการวัดค่าจีโนมพลาสติกเพื่อช่วยการแยกโรคในผู้ป่วยที่มีอาการเคลื่อนไหวผิดปกติในอนาคต

#### 5. ความเสี่ยงและความไม่สะดวกสบาย

เมื่อมีการเจาะเลือดสำหรับการตรวจทางห้องปฏิบัติการ ท่านอาจได้รับความเจ็บปวดบ้าง มีเลือดออกเล็กน้อยหรือรอยช้ำที่บริเวณที่เจาะด้วยเข็ม

#### 6. คำชี้แจงเกี่ยวกับสิทธิของผู้ป่วยและอาสาสมัคร

ผู้ป่วยมีสิทธิที่จะปฏิเสธการเข้าร่วมการศึกษาวินิจฉัย โดยยังมีสิทธิที่จะได้รับการดูแลจากแพทย์ตามปกติ ผู้ป่วยหรืออาสาสมัครมีสิทธิที่จะถอนตัวจากการวิจัยครั้งนี้เมื่อไรก็ได้ แม้ว่าท่านจะได้ลงนามในการวิจัยแล้ว โดยท่านจะไม่ได้รับผลเสียใดๆทั้งสิ้น และข้อมูลส่วนตัวของท่านจะไม่ถูกบันทึกเพิ่มเติม

#### 7. การปกปิดเป็นความลับ

ข้อมูลนี้อาจนำไปสู่การเปิดเผยตัวของท่าน จะได้รับการปกปิดและไม่เปิดเผยต่อสาธารณชน ในกรณีที่ผลการวิจัยได้รับการตีพิมพ์ ชื่อและที่อยู่ของท่านจะได้รับการปกปิดเสมอ โดยจะใช้เฉพาะรหัสโครงการวิจัยของท่านเท่านั้น

จากกรณีขอมลลงนามของท่าน แพทย์ผู้วิจัยสามารถเข้าไปทำการตรวจสอบบันทึกข้อมูลทางการแพทย์ของท่านได้ตลอดเวลาแม้จะสิ้นสุดโครงการวิจัยไปแล้วก็ตาม หากท่านต้องการยกเลิกการใช้สิทธิดังกล่าว ท่านสามารถเขียนบันทึกขอยกเลิกการให้คำยินยอม โดยส่งไปที่ พญ. เฮเลน หลิง หน่วยประสาทวิทยา ภาควิชาอายุรศาสตร์ จุฬาลงกรณ์มหาวิทยาลัย

ขอบคุณในการร่วมมือของท่านมา ณ ที่นี้

ศูนย์วิจัยทรัพยากร  
จุฬาลงกรณ์มหาวิทยาลัย

### 8. คำยินยอมของผู้เข้าร่วมโครงการวิจัย

ข้าพเจ้าได้อ่านและมีความเข้าใจข้อมูลที่อยู่ในเอกสารข้างต้นและได้รับโอกาสในการพิจารณา และถามคำถามเกี่ยวกับข้อมูลที่เกี่ยวข้องกับการมีส่วนร่วมในการศึกษานี้ของข้าพเจ้า ข้าพเจ้าได้พูดคุยโดยตรงกับแพทย์ และได้รับคำตอบทุกคำถามจนข้าพเจ้าพอใจ ข้าพเจ้าได้รับสำเนาเอกสารให้คำยินยอมนี้ 1 ฉบับ ข้าพเจ้าสมัครใจและยินยอมเข้าร่วมโครงการศึกษานี้โดยการตรวจทางห้องปฏิบัติการที่กล่าวข้างต้น การวิเคราะห์ผลเลือด และการเก็บข้อมูลประวัติการรักษาของข้าพเจ้า

ข้าพเจ้าอนุญาตให้เปิดเผยข้อมูลในบันทึกทางการแพทย์ (ข้อมูลที่รวบรวมจากการเข้าร่วมการศึกษานี้) สำหรับการยื่นต่อหน่วยงานกำกับดูแลของรัฐหรือหน่วยงานอื่นๆ ของรัฐ และสำหรับการตีพิมพ์ที่อาจเกิดขึ้นโดยแพทย์ผู้วิจัยหรือผู้ร่วมงานของแพทย์ ข้อมูลบันทึกทางการแพทย์อาจถูกตรวจสอบจากหน่วยงานของรัฐหรือคณะกรรมการจริยธรรม แต่อย่างไรก็ตาม การถือเป็นการลับจะถูกนำมาปฏิบัติ เพื่อให้ชื่อท่านไม่ถูกระบุในหน่วยงานต่างๆ ของการศึกษานี้

ผู้ป่วยลงนาม

วันที่ \_\_\_\_\_ ลายเซ็น \_\_\_\_\_ ชื่อ \_\_\_\_\_

พยาน หรือผู้แทนโดยชอบธรรม (เฉพาะที่เกี่ยวข้อง)

วันที่ \_\_\_\_\_ ลายเซ็นพยาน / ชื่อพยาน /  
ผู้แทนโดยชอบธรรม ผู้แทนโดยชอบธรรม

แพทย์ผู้ลงนามวิจัย

วันที่ \_\_\_\_\_ ลายเซ็นแพทย์ \_\_\_\_\_ ชื่อแพทย์ \_\_\_\_\_

ในกรณีที่ผู้เข้าร่วมโครงการ ไม่สามารถเขียนชื่อได้ ให้ลงนามโดยวิธีประทับลายนิ้วมือแทน และขอให้ผู้แทนโดยชอบธรรมลงนามเป็นผู้รับรองด้วย

จุฬาลงกรณ์มหาวิทยาลัย

## Appendix C

Calculations for sample size estimation (chapter 5.3)

	Patients with movement disorders	Control Population
Mean Cp level (mg/dl), X	X <sub>-</sub> = 18.47	X <sub>+</sub> = 32
Standard Deviation, SD	SD <sub>-</sub> = 2.4	SD <sub>+</sub> = 37

$$S_d^2 = SD_-^2 + SD_+^2 - 2(\lambda)(SD_-)(SD_+) = 1159 (\lambda = 0.5)$$

$$\text{Sample size} = N = \frac{(Z_{\alpha/2} + Z_{\beta})^2 \sigma^2}{(\mu_1 - \mu_2)^2} \quad (\sigma^2 = \text{Variance of difference} \sim S_d^2)$$

( $\mu_1 \sim X_-; \mu_2 \sim X_+$ )

$$\text{Type I error} = \alpha = 0.05; \quad Z_{\alpha/2} = 1.64 \text{ (one-tailed test)}$$

$$\text{Type II error} = \beta = 0.2; \quad Z_{\beta} = 0.84$$

$$= \frac{2(1.64+0.84)^2 37^2}{(32-18.47)^2} = 92$$

With 10% margin of technical error, the minimum sample size = 102

ศูนย์วิทยุทรัพยากร  
จุฬาลงกรณ์มหาวิทยาลัย

## Appendix D

Case Report Form for Patients (chapter 5.4)

Patient No.:.....

## Case Report Form

**Ceruloplasmin, copper and iron parameters in Movement Disorders:  
Implications of pathogenesis and diagnostic significance**

Date: .....

Name: .....

HN: .....

Age: .....years

Gender: Male  Female Clinical Diagnosis: ..... OR Healthy Volunteers Duration of symptoms: .....years OR Not applicable Family History of Abnormal Movements: No  Yes  \_\_\_\_\_

Current medications:

1. ....

2. ....

3. ....

*For patients with Parkinson's Disease only:*

Hohn And Yahr Score:.....

Mini Mental Status Examination:.....

Tremor predominant  OR Akinetic-rigid subtype 

Current Medications:

- Levodopa
- Dopamine agonist
- 
- Monoamine Oxidase Inhibitors
- Anti-cholinergic

Duration of treatment:.....years

Blood Test Results:

Blood Tests	Results	Normal Range
Ceruloplasmin	mg/dl	27-37 mg/dl
Copper	µg/dl	70-140 µg/dl
Iron	µg/dl	50-150 µg/dl
Ferritin	ng/ml	Male: 30-300 ng/ml Female: 10-200 ng/ml
Total iron binding capacity (TIBC)	%	228-428 %
γ-Glutamyl transpeptidase (GGT)	U/liter	1-94 U/liter

## Appendix E

Case Report Form for Healthy Volunteers (chapter 5.4)

Subject No: \_\_\_\_\_

**Case Report Form for Healthy Volunteers****Ceruloplasmin, Copper and Iron Parameters in Movement Disorders:  
Implications of Pathogenesis and Diagnostic Significance**

1. Date: .....
2. Age: .....years
3. Gender: Male  Female
4. Occupation: \_\_\_\_\_
- Regular contact with heavy metals YES  NO
  - Regular contact with pesticides YES  NO
4. Present Medical Conditions:
- Pregnancy YES  NO
  - Infection e.g. Common cold, wounds, fever YES  NO
  - Malignancy YES  NO
  - Kidney Diseases YES  NO
  - Liver Diseases YES  NO
  - Alzheimer's Disease YES  NO
  - Parkinson's Disease YES  NO
  - Wilson's Disease YES  NO
  - Others, please specify \_\_\_\_\_
5. Current Medications:
- Oral Contraceptive Pills YES  NO
  - Hormones YES  NO
  - Others, please specify \_\_\_\_\_
6. Family History:
- Parkinson's Disease YES  NO
  - Dystonia YES  NO
  - Tremor YES  NO
  - Wilson's Disease YES  NO
  - Other Hereditary Diseases, please specify \_\_\_\_\_

## 7. Blood Test Results:

Blood Tests	Results	Normal Range
Ceruloplasmin	mg/dl	20-60 mg/dl
Copper		0.66-1.5
Serum Iron	µg/dl	59-158 µg/dl
Ferritin	ng/ml	30-400 ng/ml
TIBC	%	228-428 %
GGT	U/liter	7-50U/liter



## Appendix F

### Red Cross Eligibility Guidelines for Volunteer Blood Donation:

Website: <http://www.redcross.org/donate/give/>

#### BASIC REQUIREMENTS:

- Be in generally good health and feeling well.
- Be at least 17 years of age; upper age 60 (420d\*).
- Weigh at least 110 pounds (45 kg).
- Pulse: 80 to 100 beats/min and regular.
- Temperature: Should not exceed 99.5 (37.5c).
- Blood Pressure: acceptable range is 160/90 to 110/60.
- Skin: the venipuncture site should be free of any lesion or scar of needle pricks indicative of addiction to narcotics or frequent Blood donation (as in the case of professional Blood donors).

#### DONATION FREQUENCY (may vary):

- Whole Blood donors may donate every 56 days.
- Plasma donors may donate twice a week (max. every 48 hours.)
- Platelet donors may donate a maximum of 24 times per year.
- Other specialized donations are subject to other rules.

#### DO NOT DONATE BLOOD IF:

- You have ever tested positive for HIV,
- You have ever injected yourself with drugs or other substances not prescribed by a physician,
- You are a man and have had sex with another man, even once,
- You have hemophilia or another Blood clotting disorder and received clotting factor concentrate,
- You have engaged in sex for drugs or money since 1977,
- You have lived in western Europe since 1980,
- You have been held in a correctional facility (including jails, prisons and/or detention centers) for more than 72 hours in the last 12 months,
- You were born in, lived in or had sex with anyone who lived in, or received Blood products in Cameroon, Central African Republic, Chad, Congo, Equatorial Guinea, Gabon, Niger or Nigeria since 1977 (this list changes frequently; updates are very important) or,
- You are, or have been a sexual contact of someone in the above list.

NOTE: There is a special watch for potential donors who have visited or lived in England/United Kingdom from 1980 to 1999, and those who have lived and/or worked in Western Europe since 1980.

#### MEDICAL CONDITIONS:

- Accident & Injury: can donate if otherwise healthy
- Aids: can not donate

- Allergies: can donate if there is no infection present and there is no treatment ongoing
- Anemia: defer donation until no symptoms exist
- Arthritis: can donate if mild and not on medication
- Asthma: those with severe asthma requiring regular treatment can not donate; can donate if there are no symptoms evident
- Babesiosis: can not donate
- Blood disorders or bleeding tendencies: can not donate
- Blood Pressure: acceptable range is 160/90 to 110/60. (see medication section below for medication restrictions.)
- Brain or spinal surgery that required a transplant of brain covering (dura mater): can not donate
- Bronchitis: defer donation until four weeks or after recovery
- CJD: When a Blood relative has been diagnosed with Creutzfeldt-Jakob Disease (CJD), or there is an increased family risk of CJD; can not donate
- Cancer: Basal cell, squamous cell skin cancers and keratosis; can not donate until removed and healed. Melanoma; can not donate. Malignant tumors; can donate five years after removal of early stage contained solid tumor, no chemotherapy, and in remission
- Chicken Pox: defer donation until four weeks after recovery
- Chlamydia: like all other venereal diseases; a minimum of a one year deferral is required
- Colds, fever, flu, sore throat: can not donate until symptoms (sore throat, cough, respiratory infection, headache) are completely gone
- Cold Sore, Fever Blister, Canker Sore: can donate
- Colitis: can not donate
- Colostomy: can not donate
- Dementia: can not donate
- Dengue: defer donation until four weeks after recovery
- Dermatitis: can donate if mild; defer donation if severe
- Diabetes: can donate if treatment is by diet control and condition is stable; defer donation if on medication
- Diarrhea: defer donation until three weeks after recovery
- Eczema: can donate if mild. defer donation if severe
- Emphysema: can not donate
- Filariasis: can not donate
- Food Poisoning: defer donation for one week after full recovery
- Gastroenteritis: defer donation for one week after full recovery
- Gall Stone: can donate if not on medication
- Gonorrhea/Syphilis: defer donation for one year after complete recovery
- Gout: can not donate
- Heart attack: can donate if greater than one year since, and no symptoms present, the attending Blood authority physician must carefully evaluate
- Heart surgery, Coronary artery bypass surgery (CABG) or angioplasty: can donate one year after surgery, if no history of heart attack, and the donor is on no medication for the heart (aspirin is okay)
- Hemochromatosis: can not donate
- Hepatitis: Hepatitis or undiagnosed jaundice after age ten; can not donate. Positive hepatitis test: can not donate. Can donate if the history of hepatitis is pertaining to mononucleosis or CMV infection

- Herpes (genital): can donate four weeks after lesions completely clear
- Leprosy: can not donate
- Malaria; had Malaria in last three years: defer donation for three years after full recovery (also see Travel and Residency Restrictions below)
- Pregnancy and Miscarriage: can donate after six weeks of full term normal delivery. Can donate six weeks after termination in third trimester. First or second trimester miscarriage can donate after stable
- Prostate: can not donate
- Sexually transmitted diseases - Genital herpes: can not donate until all lesions are completely clear
- Sickle Cell Trait: can not donate
- Seizures in the last five Years: can not donate
- Spondylosis: can donate if feeling well and not under any treatment at all
- Strokes: can not donate
- Surgery (all): can donate after healed and released from physician care.
- Syphilis: see Gonorrhea
- Thyroid: for Hypothyroid, can donate if feeling well and euthyroid on thyroxine for six months. For Hyperthyroid: can not donate until euthyroid for six months.
- Tuberculosis: can not donate until two years after complete cure
- Viral Infection: can donate after cure and off treatment
- Worms: can donate after complete cure

#### MEDICATION GUIDELINES:

- Acetaminophen (e.g. Tylenol): may be taken in normal moderate doses before any Blood donation
- Accutane: four-week deferral
- Allergy medication: can donate
- Antibiotics: 72-hour deferral after infection is healed
- Anti-inflammatory drugs (Advil, Ibuprofen, Motrin and Naprosyn): may not be taken within 24 hours before a platelet donation (some other rules may apply)
- Aspirin-containing products or Feldene and Lodine XL: may not donate within 36 hours before platelet donation
- Birth control pills: can donate
- Blood pressure medication: can donate under present FDA and American Red Cross standards in force
- Depression medication: can donate
- Diabetic medication - Injected bovine (beef) insulin since 1980; can not donate
- Diet pills: can donate
- Diuretics: can donate
- Female hormone pills: can donate
- Any human pituitary-derived hormone (i.e. growth hormone): can not donate
- Soriatane (Acitretin): three-year deferral
- Tegison (used to treat a severe skin disorder): can not donate if ever taken
- Thyroid medication: can donate if stabilized

#### IMMUNIZATION EXCLUSIONS:

- Polio, mumps, smallpox: two-week or more deferral
- Rubella or Rubeola (types of measles): four week deferral

- Tetanus, diphtheria, flu, Hepatitis B: can not donate until any reaction is over

#### OTHER POSSIBLE RESTRICTIONS:

- Acupuncture: one-year deferral
- Alcohol: defer donation if consumed in last 12 hours
- Body piercing: one-year deferral
- Cocaine: taking through the nose (snorting); one-year deferral minimum, local Blood authority will prevail
- Dental work - Cleaning and fillings: one-day deferral; Root canal: three-day deferral after work is complete
- Ear piercing: can donate if the piercing was performed in a doctor's office (with written verification) otherwise, one-year deferral
- Electrolysis: defer donation for one year
- Hepatitis exposure: one-year deferral
- Menstruation: can donate
- Rape: one-year deferral
- Smoker: can donate
- Tattoo in the last 12 months: one-year deferral
- Transfusion: defer donation by one year if undergone transfusion with Blood products. Can donate if undergone autologous transfusion only

#### TRAVEL and RESIDENCY OUTSIDE of the UNITED STATES:

- England/United Kingdom - visited or lived in from 1980 to 1999: deferred indefinitely (this standard varies between United States FDA and The American Red Cross and the American Association of Blood Banks.
- Western Europe - visited or lived in since 1980 deferred indefinitely
- Born in, lived in or had sex with anyone who lived in, or received Blood products in, Cameroon, Central African Republic, Chad, Congo, Equatorial Guinea, Gabon, Niger or Nigeria since 1977 (this list changes frequently; updates are very important): deferral indefinitely.
- Lived or traveled in an area where Malaria is prevalent (Central America and South America, etc.): three-year deferral,
- Other international travelers: different restrictions apply as precaution against mad cow disease, depending on what blood bank and region •

ศูนย์วิทยุทรัพยากร  
จุฬาลงกรณ์มหาวิทยาลัย

**AUTHOR'S BIOGRAPHY**  
**HELEN LING, BMedSc(Hons), BMBS(UK), FRCP(T)**

**Personal Information:**

Date & Place of Birth: 4<sup>th</sup> July, 1976 (Hong Kong)

**Education:**

June 2007 – Present Master Degree in Medical Science, MSc  
 1995 – 2000 Bachelor of Medicine and Bachelor of Surgery, BMBS  
 Faculty of Medicine, Nottingham University, England  
 1995 – 1997 Bachelor of Medical Science, BMedSc(Hons)  
 Faculty of Medicine, Nottingham University, England

**Professional Positions:**

June 2007 – Present Fellow in Movement Disorders  
 Chulalongkorn University Hospital, Thailand  
 2004 – 2007 Resident in Neurology  
 Chiang Mai University Hospital, Thailand  
 2003 – 2004 Resident in Internal Medicine  
 Chiang Mai University Hospital, Thailand  
 2000 - 2001 Pre-Registration House Officer (PRHO)  
 Derby and Burton-On-Trent, England

**Professional Qualifications:**

2007 Thai National Board of Neurology  
 2007 Educational Commission for Foreign Medical  
 Graduates (ECFMG) Certificate  
 2000 Bachelor of Medicine and Bachelor of Surgery

**Grant:**

2008 Thailand Research Fund  
 2008 Bronze Medal for Video Olympics Presentation at 12<sup>th</sup>  
 Annual Meeting of Movement Disorders Society

**Peer-Reviewed Journal Articles:**

1. Bhidayasiri R., Ling H. Multiple System Atrophy. *Neurologist* 2008;14:224-237
2. Bhidayasiri R., Ling H. Treatment of Parkinson's Disease in Thailand: Review of the Literature and Practical Recommendations. *J Med Assoc Thai* (In Press)
3. Kongsangdao S., Karoksri S., Chankrachang S., Ling H., Kanokporm O., Wantana P. Neurological Complications in AIDS Patients Receiving HAART: A 2-year Retrospective Study. *Eur J Neurol* 2006;13(3):233-9.
4. Kongsangdao S., Kanoksri S., Chankrachang S., Ling H. Neurological Complications in AIDS Patients: the 1-year Retrospective Study. *Eur J Neurol* 2004;11(11):755-9

**Book Chapters:**

1. Ling H. Myoclonus. In Bhidayasiri R., Phanthumchinda K. Practical Movement Disorders. Chulalongkorn Comprehensive Movement Disorders Center, 2007.
2. Desudchit T., Ling H. Tics and Tourette's Syndrome. In Bhidayasiri R., Phanthumchinda K. Practical Movement Disorders. Chulalongkorn Comprehensive Movement Disorders Center, 2007.
3. Phanthumchinda K., Ling H. Levodopa in Atypical Parkinsonian Disorders. In Bhidayasiri R., Phanthumchinda K. Textbook of Levodopa Therapy. Chulalongkorn Comprehensive Movement Disorders Center, 2008.