

CHAPTER I

GENERAL BACKGROUND

1. Introduction

In recent years, the development of intraoral mucoadhesive dosage form has been interested in delivery various drugs via oral mucosa for either local or systemic administration. The intraoral route appears to offer a series of advantages, such as a good accessibility, robustness of epithelium, facile removal of the dosage form in case of need, relatively low enzymatic activity, satisfactory patient acceptance and compliance. Moreover, in the case of systemic delivery, this route offer the advantages of partly circumventing drug degradation in the GI tract and avoiding the hepatic first pass metabolism (Burgalassi et al., 1996). Eventually, the mucoadhesive dosage forms have replaced a number of conventional dosage forms in medicine and dentistry.

The mucoadhesive drug delivery systems for oral mucosal administration have been developed in the number of different dosage forms, include films, gels, ointments and tablets (Peh and Wong, 1999). The mucoadhesive films have clearly defined many advantages over other dosage forms. For instance, the films allow more exact dosing and easier application than gels and ointments. In addition, gels were given the relatively short residence time on the mucosa, which is easily washed away and removed by saliva (Kohda et al., 1997). Although, the mucoadhesive tablets were given the latter advantages too, mucoadhesive films may preferred over adhesive tablet in terms of flexibility and comfort. Therefore, the mucoadhesive films were given more patients' acceptability and patients' compliance than other mucoadhesive dosage forms. The latter advantages are the rationale for developing the mucoadhesive films of triamcinolone acetonide and miconazole nitrate for oral mucosal administration.

Polysaccharide gel (PG) isolated from dried fruit-hulls of durian (*Durio zibethinus* L.) was a new water soluble natural polymer which is biodegradable,

biocompatible and applicable in pharmaceutical industry. PG have a wide range of applications in food and pharmaceutical products such as jelly, jam, salad dressing, emulsion, suspension and tablet (Pongsamart et al., 1989 ; Pongsamart and Panmaung et al., 1998 ; Umprayn et al., 1990). Toxicity test of polysaccharide gel have been reported, a high oral single dose (2g/kg) have not induced severe toxicity in male mice and rats (Pongsamart, Sukrong and Tawatsin, 2001). No toxic effects have been observed in subacute treatment in male mice and female mice confirmed the consumptive safety of PG (Pongsamart, Sukrong and Tawatsin, 2002).

Recent research on the applications of natural polysaccharide gel has receiving considerable attention because these compounds are characterized by a high hydrolytic stability and ease of biodegradability. The natural polysaccharides from dried fruit-hulls of durian are high-molecular weight polysaccharides build up from relatively few sugars, the most common of which are galacturonic acid, glucose, rhamnose, arabinose, and fructose (Gerddit, 2002). Polysaccharides are usually defined as polymers that are solubilized by water from plant cell walls. It has great industrial potential due to its useful physical and chemical properties and biological activities. Examples of potential future applications of polysaccharides are as food additives, thickeners, emulsifiers, gelling agents, adhesives, and adsorbents. Most of the polysaccharide gel (PG) fraction, obtained from hot-water extraction and precipitation in acid alcohol, is soluble in water. PG has film forming characteristic similar to cellulose derivatives such as hydroxypropyl methylcellulose (Gerddit, 2002), then PG is expect to probably apply as a film forming agent in preparation of dressing-patch.

Polysaccharide gel (PG) also has antibacterial property (Nantawanit et al., 2001) and wound healing property in pig skin (Nakchat, 2002). Preparation of PG film dressing has shown wound closure acceleration, smaller wound area obtained after 12 days treatment with PG film dressing when compared to the control (using 1% povidone iodine) and treated wounds have shown completely wound closure on days 18. In histologically study of tissue reaction have found that the wound treated with PG has shown mild score of chronic inflammatory cells aggregated in dermal layer, mild fibroblasts and no remarkable lesion to mild dermal granuloma formation. From this results, PG would be applied to used as wound healing agent in oral cavity. The objective of this study was to prepare mucoadhesive polysaccharide film base with and

without drug (triamcinolone acetonide or miconazole nitrate), an alternative dosage form for oral administration. Plasticizer was added in formulation to improve the physical properties of the PG films. The effects of plasticizers using sorbitol, polyethylene glycol 400, polyethylene glycol 6000, hydroxypropyl methylcellulose E15 on the mechanical properties of PG films were investigated. The physical properties of PG films were also tested. The release of drug from the mucoadhesive film was determined by in vitro method using modified Franz's diffusion cells. The interactions between ingredients and drug were determined by infrared spectrophotometry.

2. Literature reviews

2.1 Bioadhesive Drug Delivery System

Bioadhesion is defined as the state in which two materials, at least one of which being of a biological nature, are held together for an extended period of time by interfacial forces. For drug delivery purpose, the term bioadhesion implies attachment of a drug carrier system to a specific biological location. The biological surface can be epithelial tissue, or it can be the mucous coat on a surface of a tissue. If adhesive attachment to a mucus coat, the phenomena is referred to as mucoadhesive (Jimenez-Castellanos et al., 1993).

In recent years, the mucoadhesive drug delivery system have been interested because it could resolve several problems of controlled release systems (Gandhi and Robinson, 1988) : a) it localizes drugs in particular region thereby improving and enhancing bioavailability; b) the strong interaction between the polymer and the mucus lining of the tissue helps increase contact time and permit localization, an essential issue when modification of tissue permeability is important for delivery; c) to inhibit metabolizing enzymes in localized area; d) to deliver agents locally for the purpose of modulating antigenicity.

2.2 Absorption of Drugs through the Oral Cavity (Shojaei, 1998)

Absorption of drugs through the oral cavity was noted early as 1847 by Sobrero, the discoverer of nitroglycerin, and systemic studies of oral cavity absorption were first reported by Walton and Lacey in 1935. Since then, substantial effort has been focused on drug absorption from a drug delivery system in a particular region of oral cavity. As a site for drug delivery, the oral cavity offers many advantages over other route of drug administration. The mucosal lining of the oral cavity are readily accessible, robust and heal rapidly after local stress or damage. Oral mucosal drug delivery systems can be localized easily and are well accepted by patients. Therefore, it is evident that the oral cavity can serve as a site for systemic drug delivery. The total surface area of the oral cavity is about 100 cm². The mucosal membranes of the oral cavity can be divided into five regions: the floor of the mouth (sublingual), the buccal mucosa (cheek), the gums (gingiva), the palatal mucosa, and the lining of the lips. These oral mucosal regions are different from each other in terms of anatomy, permeability to drug, and their ability to retain a system for a desired length of time. Although the buccal mucosa is less permeability than the sublingual mucosa and it does not yield a rapid onset on action as seen with sublingual delivery, mucosa of the buccal area has expanse of smooth and relatively immobile surface, which is suitable for placement of a retentive system. These characteristics make the buccal mucosa a more appropriate site for prolong systemic delivery of drugs. It has been shown that buccal route offers excellent opportunities for systemic delivery of drugs. In general, drug delivery through this route has the advantages of preventing the drug from degradation in the gastrointestinal tract, avoiding first-pass effect, and bypassing gastrointestinal absorption.

2.3 Mucus Layer (Duchene et al., 1988)

The mucus covering the mucosa. It is secreted by the goblet cells. It is highly viscous liquid, adhering to the epithelium. This mucus layer, which covers the epithelial surface, has various roles : a) protection against various aggression: mechanical, chemical, bacterial or viral; b) diffusion barrier in tissue absorption of drug and other substrates, as it influences the bioavailability of drugs; c) it has strong cohesive properties and firmly binds to epithelial cell surface as a continuous gel

layer. One must consider the structure and density of oligosaccharide side chains of the cell surface, their interaction with lipids and proteins, and their fuzzy coat glycocalyx in developing mechanism of bioadhesion. The understanding of bioadhesion and active ingredient diffusion mechanism requires knowledge of the mucus.

Chemical Composition

The composition of mucus varies widely depending on animal species, anatomical location, and whether the tissue is in a normal or pathological state. In general, its components are water more than 95% of mucus, glycoproteins (0.5 to 5%), lipid in low proportions, mineral salts (1%) and free proteins (0.5 to 1%).

Glycoproteins are the main mucus components, responsible for its viscosity, adhesive and cohesive properties. The high molecular weight glycoproteins are known to form disulfide bonds as well as ionic bonds and physical entanglements. The molecular weight of glycoproteins varies from 2×10^6 to 14×10^6 Dalton. Basically, glycoproteins consist of protein core on which attached oligosaccharide chains (Figure 1a). Galactose, fucose, N-acetylgalactosamine, N-acetylglucosamine and N-acetylneuraminic acid (sialic acid) are typically found in mucin molecules. The structure of these carbohydrates are shown in Figure 3. Amino acids are principally serine, threonine and proline. Linkages between the protein core are of the O-glucidic type, between N-acetylgalactosamine and serine or threonine. Each carbohydrate chain terminates either with a sialic acid group (pK_a 2.6) or with an L-fucose group. Hence mucin molecule behaves as anionic polyelectrolytes at natural pH. Sulfate residues contribute equally to this negative charge. Numerous hydroxyl groups of carbohydrates on mucin molecules have the potential to interact with other polymers that can form hydrogen bonds. The mucin gel structure is consequence of the intermolecular association of glycoproteins in a polymeric network. Previously thought to be tetramer (Figure 1b), the polymer is now believed to be a terminally linked chain with numerous crosslinking. It has been proposed that chains result from disulfide bonds (interchain) and macromolecular association are due to physical bonds stabilized by electrostatic interactions (hydrogen bonding, salt linkage) or other non-

covalent contacts between the oligosaccharide chains or between chains and the protein core of the molecule (Figure 2).

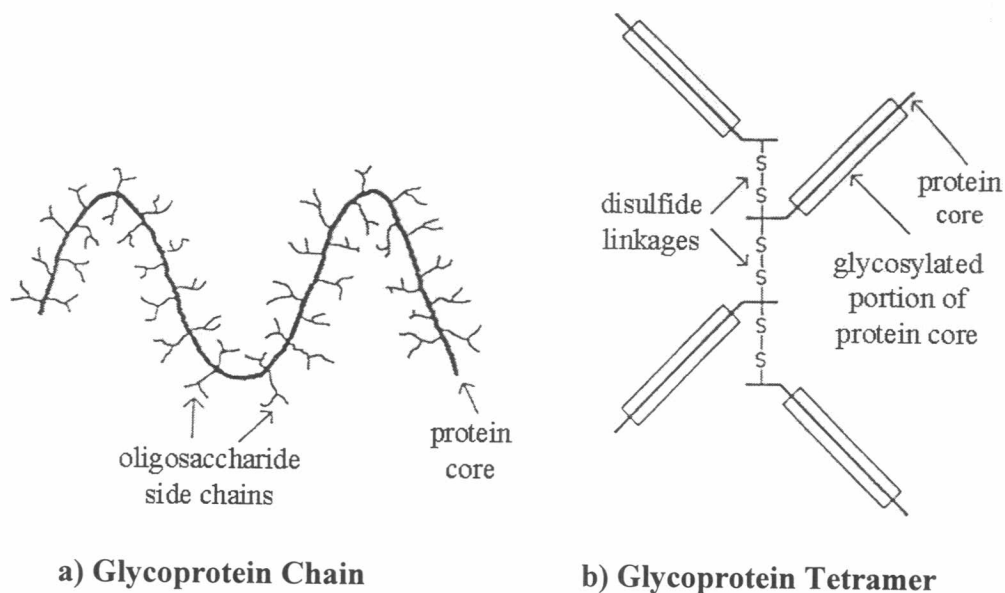

Figure 1 Schematic representation of mucus

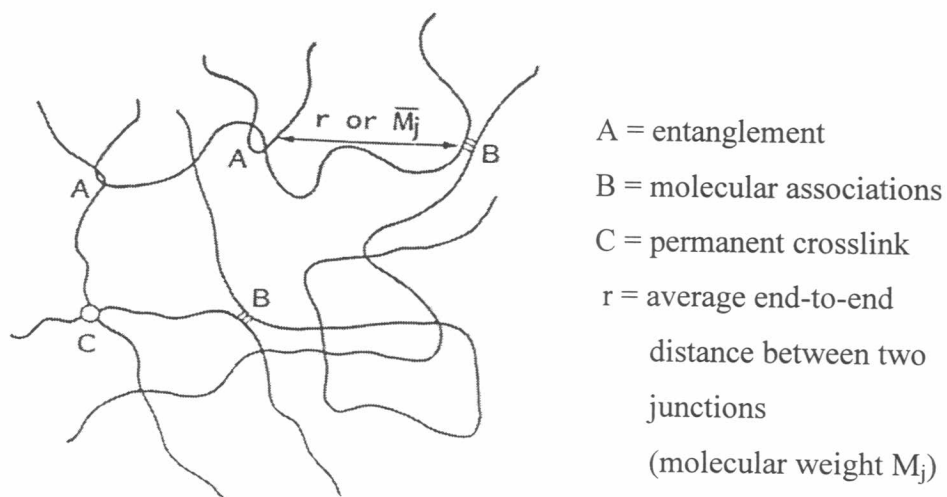

Figure 2 Crosslinked structure of mucus network

2.4 Oral Cavity Environment

The cells of the oral epithelia are surrounded by an intercellular ground substance, mucus, the principle components of which are complexes made up of proteins and carbohydrates. These complexes may be free of association or some may be attached to certain regions on the cell surfaces. This matrix may actually play a role in cell-cell adhesion, as well as acting as a lubricant, allowing cells to move relative to one another. Along the same line the mucus is also believed to play a role of adhesion of mucoadhesive drug delivery systems (Peppas and Buri, 1985). At physiological pH the mucus network carries a negative charge (due to the sialic acid and sulfate residues) which may play a role in mucoadhesion. At this pH mucus can form strongly cohesive gel structure that will bind to the epithelial cell surface as a gelatinous layer (Gandhi and Robinson, 1988).

Another feature of the environment of the oral cavity is the presence of saliva produced by the salivary glands. Saliva is the protective fluid for all tissues of the oral cavity. It protects the soft tissues from abrasion by rough materials and from chemicals. It allows for the continuous mineralisation of the tooth enamel after eruption and helps in remineralisation of the enamel in the early states of dental caries. Saliva is an aqueous fluid with 1% organic and inorganic materials. The major determinant of the salivary composition is the flow rate. At high flow rate, the sodium bicarbonate concentration increase leading to an increase in the pH. The daily salivary volume is between 0.5 to 2 liters and it is this amount of fluid that is available to hydrate oral mucosal dosage forms. A main reason behind the selection of hydrophilic polymeric matrices as vehicles for oral transmucosal drug delivery systems is this water rich environment of oral cavity (Shojaei, 1998).

2.5 Mechanisms of Mucoadhesion

Understanding the mechanisms of mucoadhesion is fundamental to the development of mucoadhesives. Not much is know, however, about this mechanism. Initially, attempts were made to explain the mucoadhesive phenomena by the mechanism of nonbiological adhesion, such as electron transfer, wetting, diffusion, adsorption, fracture, and mechanical interlocking theories. Although these theories

have provided some insights, no single theory has been successful in explaining the mucoadhesive phenomena.

The process involved in the formation of such bioadhesive bonds has been described in three steps: (1) wetting and swelling of polymer to permit intimate contact with biological tissue, (2) interpenetration of bioadhesive polymer chains and entanglement of polymer and mucin chains, and (3) formation of weak chemical bonds.

Mechanical or Physical Bonds

Mechanical bonds can be thought of as a physical connection of polymer and tissue, similar to interlocking puzzle pieces. On a macroscopic level, they can be caused by the inclusion of one substance into the cracks or crevices of another. On a microscopic scale, they involve the physical entanglement of mucin strands with flexible polymer chains and the interpenetration of mucin strands into the porous structure of a polymer substrate (Figure 3). The rate of penetration of polymer strands into the mucin layer is dependent on chain flexibility and diffusion coefficient of each. The strength of adhesive bond is directly proportional to the depth of penetration of polymer chains. Other factors that influence bond strength include the presence of water, the time of contact between the materials, and the length and flexibility of the polymer chains.

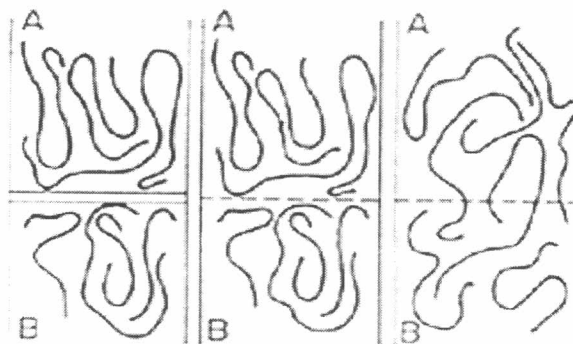

Figure 3 Chain interpenetration during bioadhesion of polymer (A) with mucus (B)

Chemical Bonding

Chemical bonds that most researcher have focused on develop mucoadhesive system are either Van der Waals' interactions or hydrogen bonds. Although these forces are very weak, strong adhesion can be produced though numerous interaction sites. Therefore, polymers with high molecular weights and greater concentration of reactive polar groups (such as -COOH and -OH) tend to develop more intense mucoadhesive bonds (Park and Robinson, 1985).

2.6 Theories on Bioadhesion (Gupta et al., 1992)

Several theories have been developed to describe the process involved in the formation of bioadhesive bonds. These theories have been used as guidelines in engineering possible bioadhesive drug delivery systems.

The Electronic Theory

The electronic theory is based on an assumption that the bioadhesive material and the glycoprotein mucin network have different electronic structures. On this assumption, when two materials come in contact with each other, electron transfer will occur, causing the formation of a double layer of electron charge at the interface. The bioadhesive force is believed to be due to attractive forces across this electrical double layer.

The Adsorption Theory

This theory state that the bioadhesive bound formed between an adhesive substrate and mucosa due to Van der Waal's interactions, hydrogen bonds, and relative forces. This theory is most widely accepted theory of adhesion.

The Wetting Theory

The ability of bioadhesive polymers or mucus to spread and develop intimate contact with their corresponding substrate is one important factor for bond formation. The wetting theory, which has been used predominately in regards to liquid adhesives, use interfacial tensions to predict spread and, in turn, adhesion (Peppas and Buri,

1985; Mikos and Peppas, 1990). The structure similarities of the mucus glycoprotein and mucoadhesive, would suggest a small interfacial tension exists up on wetting which promoted interaction and the development of mucoadhesive bond (Kallaway and Warren, 1996).

Li, Bhatt, and Johnston (1998) have assessed the bioadhesive properties of several different mucoadhesive buccal patches. The results of contact-angle measurements indicated that the contact-angle decreased with an increase in amount of Carbopol in the formulation. Additionally, the calculated values, using a modification of Dupre's equation, of both work of adhesion between the water and the patches (W_1) and between the patch and freshly-buccal excised rabbit buccal mucosa (W_2) increased with increase in the amount of Carbopol in the formulations. A correlation was found between the measured contact angle and the calculated values for W_2 . The direct measurement of the force required to separate a buccal patch from excised rabbit buccal mucosa with the Instron demonstrated that the adhesive strength increased with increase in amount of Carbopol. This study has shown that the measurement of contact angles alone may provide a useful technique for estimating the work of adhesion, and may serve as a convenient and rapid screening procedure to identify potential mucoadhesive buccal-patch formulations.

The Diffusion Theory

The diffusion theory suggests that interpenetration and entanglement of bioadhesive polymer chains and mucus polymer chains produce semipermanent adhesive bonds, and bond strength is believed to increase with the depth of penetration of polymer chains. Penetration of bioadhesive polymer chains into the network, and vice versa, is dependent on concentration gradients and diffusion coefficients. Obviously, any cross-linking of either component will tend to hinder interpenetration, but small chains and chain ends may still become entangled. It has not been determined exactly how much interpenetration is required to produce an effective bioadhesive bond, but it is believed to be in the range of 0.2-0.5 μm . And the more structurally similar a bioadhesive is to mucus, the greater the mucoadhesive bond will be.

The Fracture Theory

The most useful theory for studying bioadhesion through tensile experiments has been the fracture theory, which analyzes the forces required to separate two surfaces after adhesion. Furthermore, to determine fracture properties of an adhesive union from separation experiments, failure of the adhesive must be assumed to occur at the bioadhesive interface. However, it has been demonstrated that fracture rarely, if ever, occurs at the interfacial but instead occurs close to it (Figure 4) (Ponchel et al., 1987).

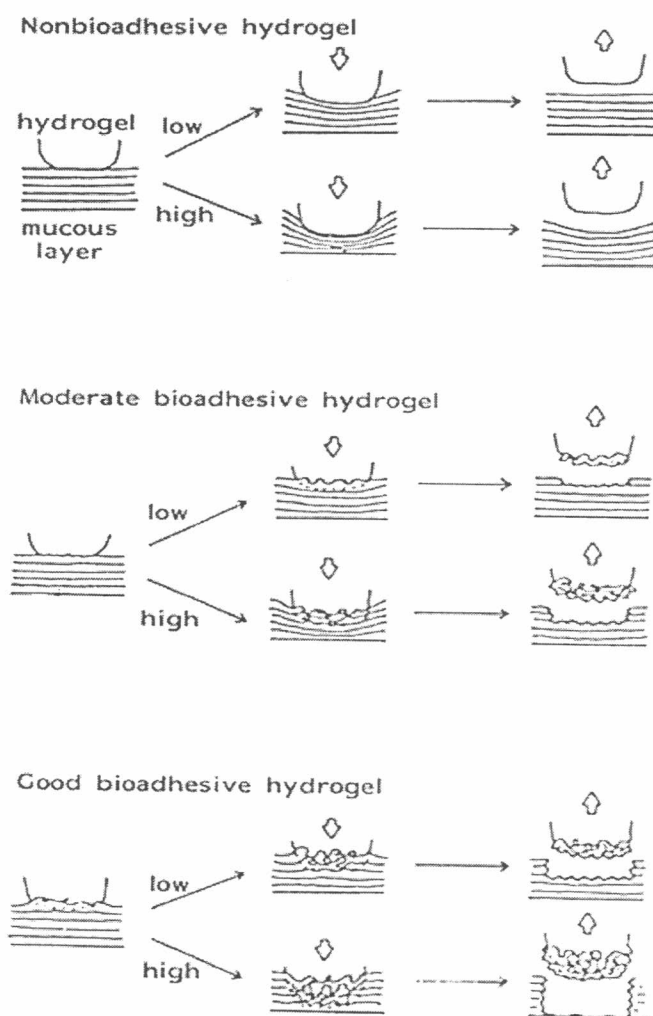

Figure 4 The interaction between mucus layers and hydrogels

2.7 Factors Affecting Bioadhesion

The bioadhesive power of a polymer or of a series of polymers is affected by the nature of the surrounding media.

Polymer-related Factors

1. Molecular weight

As mentioned by Gurny, Meyer, and Peppas (1984), it seems that the bioadhesive force increases with the molecular weight of bioadhesive polymer, up to 100,000 and beyond this level there is not much effect. It clear that, to allow chain interpenetration, the polymer molecule must have an adequate length. It is also necessary to consider the size and configuration of the polymer molecule. Besides molecular weight, spatial conformation of the molecule is also important. Despite a high molecular weight of 19,500,000 for dextrans they have similar adhesive strength to that of polyethylene glycol with a molecular weight 200,000. The helical conformation of dextran may shield many adhesively active groups unlike polyethylene glycol polymers which have a linear conformation (Gandhi and Robinson, 1988).

2. Concentration of active polymer

Bremecker (1983) relates that there is an optimum concentration of polymer corresponding to the best bioadhesion. In highly concentration systems, the adhesive strength drops significantly. In fact, in concentrated solutions, the coiled molecules become solvent-poor, and the chains available for penetrate are not numerous. This result seems to be of interest only for more or less liquid bioadhesive forms (Gurny et al., 1984). For solid dosage forms such as films, showed that increasing the polymer concentration, the stronger the mucoadhesion (Mortazavi and Aboofazeli, 2000).

3. Swelling

This characteristic is related to the polymer itself, and also to it environment. Swelling depends both on polymer concentration and on water presence. It must be remembered that, when swelling is too great, a decreasing in bioadhesion occurs due to formation of slippery.

Environment-related Factors

1. pH

At pH above the pK_a of the polymer, the strength of the interaction was progressively reduced as the greater proportion of the carboxyl groups were ionized and thus preclude from hydrogen bond formation. Also the greater swelling of the polymer as the degree of ionization increased lead to a reduction in mechanical strength and concomitant reduction in mucoadhesive properties (Figure 5 and 6) (Park and Robinson, 1985). However, Bouckaet and Remon (1993) reported studies challenge the importance of hydrogen bonding between the mucoadhesive and the glycoprotein. These workers found that in vitro work of adhesion of Carbopol 970 was equivalent at pH 5 and pH 7.4. Over this pH range the number of ionized carboxylic groups ($pK_a=4.75$) increased from 9 to 96 %. It may be deduce that physical mechanisms of mucoadhesion, i.e., interpenetration and entanglement, there are of greater importance than secondary bond interactions. In any case, there is an optimal pH for polymer adhesion (Ch'ng et al., 1985).

2. Applied strength and contact time

It is obvious that, to place a solid bioadhesive system, it is necessary to apply a defined strength. Whatever the polymer, poly(acrylic acid/divinylbenzene), poly(HEMA) (Park and Robinson, 1985) or Carbopol 934P, the adhesion strength increases with the duration of application, up to an optimum time (Chitnis et al., 1991). Chary, Veni and Rao (1999) studied the effect of contact time on adhesion strength of polymers, it would be seen that increase contact time for adhesion increased the force required in terms of weight for all the polymers.

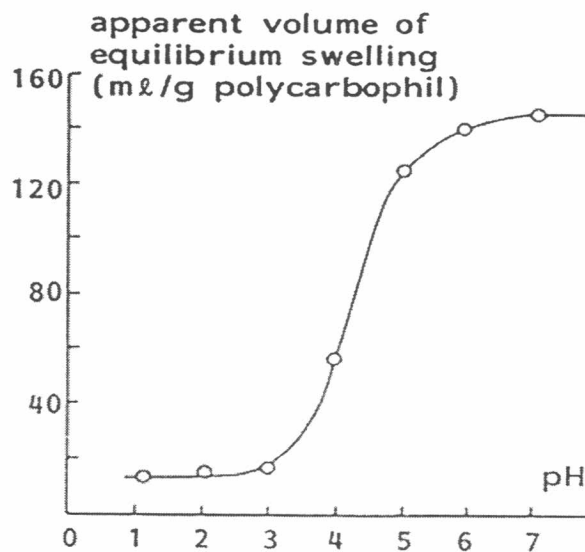

Figure 5 Apparent volume of equilibrium swelling of polycarbophil at various pH (Park and Robinson, 1985)

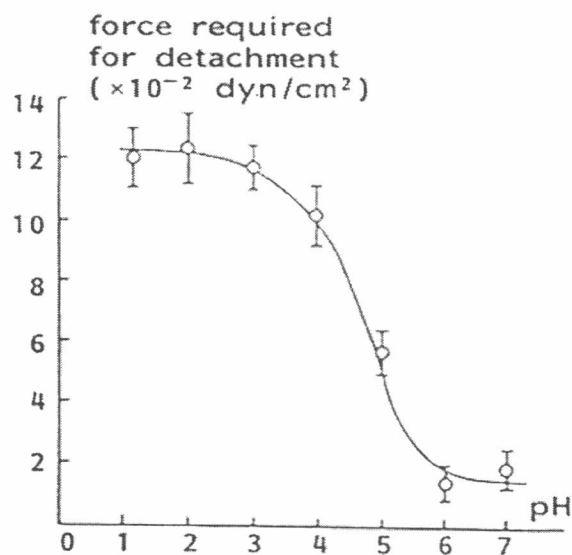

Figure 6 Effect of pH on in vitro bioadhesion of polycarbophil to rabbit stomach tissue (Park and Robinson, 1985)

2.8 Bioadhesive Polymers

Polymer that can adhere to either hard or soft tissue have been used for many years in surgery and dentistry. A bioadhesive that can be useful in oral drug delivery should ideally be nontoxic, nonabsorbable from GI tract, preferably form a strong noncovalent bond with mucin-epithelial cell surfaces, adhere quickly to moist tissue, allow easy incorporation of drug and offer no hindrance to its release, possess specific site of attachment, and be economical (Jimenez-Castellanos et al., 1993).

Many researcher groups are currently investigating the physicochemical properties of bioadhesive polymers. A general consensus of the most important physicochemical features of such mucoadhesive has been reached, and there may be summarized as follows (Kellaway and Warren, 1996): 1) generally hydrophilic molecules that contain numerous hydrogen bond forming groups; 2) surface tension characteristics suitable for wetting mucus/mucosal tissue surfaces; 3) the polymers are predominantly anionic in nature containing many carboxyl groups; 4) usually have a high molecular weight i.e., > 100,000; 5) sufficient flexibility to penetrate the mucus network or tissue crevices.

Polymers that adhere to the mucin-epithelial surface can be conveniently divided into 3 broad categories : 1) polymers that become sticky when placed in water and owe their bioadhesion to stickiness; 2) polymers that adhere through non-specific, non-covalent interaction which are primarily electrostatic in nature (although hydrogen and hydrophobic bonding may be significant); and 3) polymers that bind to specific receptor sites on the cell surface. All 3 polymer types can be used for drug delivery (Park and Robinson, 1984).

Park and Robinson (1984), using the fluorescence technique, concluded that :

- a) cationic and anionic polymers bind more effectively than neutral polymers;
- b) polyanions are better than polycations in terms of binding/potential toxicity, and further, that water-insoluble polymers give greater flexibility in dosage form design compared to rapidly or slowly dissolving water-soluble polymers;
- c) anionic polymers with sulphate groups bind more effectively than those with carboxyl groups;
- d) degree of binding is proportional to the charge density on the polymer;
- e) highly binding

polymers include carboxymethyl cellulose, gelatin, hyaluronic acid, carbopol, polycarbophil.

The polymers that are commonly used as bioadhesives in pharmaceutical applications are acacia, chitosan, carboxy polymethylene, guar gum, polycarbophil, hydroxypropyl cellulose, hydroxyethyl cellulose, hydroxypropyl methylcellulose, poly(vinylpyrrolidone), poly(vinylalcohol), sodium carboxymethylcellulose, sodium alginate, etc.

Rho and Buri (1989) showed that polycarbophil and sodium carboxymethyl cellulose adhered more strongly to mucus than hydroxypropyl methylcellulose, methylcellulose or pectin. Better adhesion occurred in the stomach than in the intestine.

In recent years, polymers, which swell in an aqueous medium, have often been used for the preparation of controlled-release dosage forms. Drug release is extent influenced by penetration of a dissolution liquid into the polymer matrix, which in turn depends upon the wetting properties of polymers itself. Cellulose polymers especially cellulose esters are also becoming popular as matrix since they are easy to prepare, they can accommodate large percentage of drug, and the release is less influenced by the process variables (Rao and Devi, 1988).

2.9 Mucoadhesive Dosage Forms

Recently a number of interesting papers dealing with adhesion have been published. With a better understanding of the mechanisms of mucoadhesion several formulated mucoadhesive dosage forms have been reported. Mucoadhesive dosage forms may be regarded as a new type of preparation that may make treatment more effective and safe not only for local diseases but also for systemic diseases.

Oral Administration

A primary objective of using mucoadhesive formulations orally would be to achieve a substantial increase in residence of the drug in the gastrointestinal tract.

Longer, Ch'ng and Robinson (1985) showed that albumin beads containing chlorthiazide, when mixed with equal sized particles of polycarbophil at ratio of 3:7 (w/w) (albumin beads:polycarbophil), and administered orally in the form of capsules to rats. The in vitro release studies showed the albumin beads and bioadhesive dosage form offered sustained-release for ≤ 8 hours. However, more than 60% was released after 2 hours, indicating that released rate still quite rapid and also that the presence of polycarbophil did not affect the rate of release of drug from the beads. In vivo release showed that nearly 90% of the beads in the polycarbophil-albumin bead dosage form remained in the rat stomach. In the absence of polymer, the majority of beads moved at least half-way down the small intestine, with some moving faster. Also, they observed that the technique of using bioadhesive in drug delivery significantly improve therapy by increasing the duration of action and bioavailability over that which was attained with a typical sustained-release dosage form. When these experiments were repeated in dogs, less satisfactory results were obtained. The explanation for the difference in finding stems from the difference in the amount of soluble mucin in the stomach of the rat versus the dog.

Chary, Vani and Rao (1999) prepared bioadhesive tablets by physical mixing of polymers and drug. The mucoadhesion was evaluated using shear stress measurement, detachment force measurement, and X-ray photography of the rabbit gastrointestinal tract. The strong interaction between the polymer and the mucous lining of the tissue helps increase contact time and permit localization. Hydroxypropyl methylcellulose K4M showed maximum adhesion in the duodenum, followed by the jejunum and ileum. Barium sulfate matrix tablets containing polymer and drug were subjected to X-ray studies in rabbits, and it was found that the tablet was mucoadhesive even after 8 hours. Enteric coating did not show any effect on mucoadhesion after passing from the stomach.

Betageri, Deshmukh, and Gupta (2001) developed the didanosine oral sustained-release tablet by using Polyox[®]WSRN-303, Carbopol[®]974P-NF, and Methocel[®]K4M as the bioadhesive release rate-controlling polymers. Tablet formulations with Polyox[®]WSRN-303 (10%) and Methocel[®]K4M (30%) showed 93 and 90% drug release, respectively, after 12 hours. The drug release was found to be linear when fitted in the Higuchi equation (square-root time equation), suggesting zero

order release. Carbopol®974P-NF was found to inhibit the complete release of the drug. Drug diffusion and swelling of the polymer (anomalous Fickian release) was found dominant in the drug release. In general, in vitro bioadhesion increased with an increase in polymer concentration.

Nasal Administration

In recent years, intranasal administration, which might be useful for many compounds which are not absorbed orally, has received a great deal of attention. Nagai et al. (1989) in their study of dogs with powder dosage forms of insulin, using a freeze-dried powder with carbopol 934, obtained the same blood concentration of insulin as with an intravenous injection of three times higher dosage. Nagai has published works on the development of a powder called 'Rhinocort' containing beclomethazone dipropionate and hydroxypropyl cellulose for the treatment of allergies (Duchene et al., 1988).

El-Hameed, and Kellaway (1997) prepared microspheres of hydrophilic polymers by the water-in-oil emulsification solvent evaporation technique with potential application as drug carriers for nasal administration. The rank order of mucoadhesion for the polymeric microspheres was Carbopol 934P > chitosan = polyvinyl alcohol = hydroxypropyl methylcellulose. The change in content of FITC-dextran showed no significant effect on the mucoadhesive strength of Carbopol 934P microspheres. The FITC-dextran was released from the microspheres initially at a constant rate. However the release rate subsequently decreased over the 24 hours test period. No differences were observed for release from Carbopol 934P, polyvinyl alcohol and hydroxypropyl methylcellulose all exhibited faster release than that achieved from the chitosan microspheres which exhibited a size-dependent release effect.

Ponchel et al. (1997) studied bioadhesion of colloidal particles systems using polystyrene and poly(lactic acid) nanoparticles as models. In vitro adsorption and desorption studies have shown that particles could be captured to considerable extent by the mucus gel layer lining in gastrointestinal tract through a mucoadhesion mechanisms. On the other hand, the in vivo behavior of the particles in the intestinal lumen has been investigated by means of the radiolabelled particles. Direct particles

translocation through the intestinal mucosa was not predominant. On the contrary, significant fraction of particles was captured by the mucus layer while the remainder of the particles underwent unmodified transit. It can be concluded that the therapeutic potential of the colloidal drug carriers after oral administration is probably to increase bioavailability by protecting the drug from denaturation in the gastrointestinal lumen, or by increasing the drug concentration for a prolonged period of time directly at the surface of the mucosa membrane.

Santus et al. (1997) prepared furosemide oral bioadhesive controlled release capsules. The results showed that the controlled release properties were not affected by the application of bioadhesive polymer but that the bioadhesive properties were substantially different. In order to assess the gastrointestinal transit time *in vivo*.

Gaserod et al. (1998) investigated alginate-chitosan as a bioadhesive drug delivery system. Calcium alginate gel beads uncoated and coated with chitosan were tested for adhesive properties, using novel techniques, negative charged chromatography particles and *in vivo* with pig esophagus and stomach mucosa. The addition of a chitosan coating increased the adhesive properties. The adherence of both coated and uncoated beads was much greater to the stomach mucosa than to the esophageal mucosa. The difference in adhesive properties between the coated and uncoated beads was also found considerably larger in the stomach mucosa.

Witschi, and Mersny (1999) prepared starch, alginate, chitosan or Carbopol[®] microparticles, containing the test protein bovine serum albumin (BSA) by spray-drying. An open-membrane system was used to determine protein release profiles and confluent, polarized Calu-3 cells sheets were used to evaluate relative bioadhesion, enhancement of protein transport and induction of cytokine release *in vitro*. Starch and alginate microparticles released protein more rapidly but were less adhesive to polarized Calu-3 cells than chitosan and Carbopol[®] microparticles. Protein transport across polarized Calu-3 cells was enhanced from Carbopol[®] gels and chitosan microparticles. A mixture of chitosan microparticles with lysophosphatidylcholine increased protein transport further. Microparticles prepared from either chitosan or starch microparticles induced the basolateral release of IL-6 and IL-8. Releases of other cytokines were not affected by an apical exposure to polymer formulation.

Ocular Administration

Loss of drug via drainage, short residence time, tear turnover and protein binding are some of the problems associated with ocular administration of drug. Hui and Robinson (1987) showed, using progesterone as the model drug, that the area under the curve of an aqueous humor drug concentration versus time plot was 4.2 times greater than conventional suspensions in rabbits.

Cervix Administration

Machida et al. (1979) developed the topical, disk-like dosage form for carcinoma coli. The 300 mg flat-faced disks measured 13 mm in diameter and about 2 mm in thickness and were made by direct compression of mixture of bleomycin hydrochloride and a combination of hydroxypropyl cellulose and other water-soluble polymers. A combination of hydroxypropyl cellulose and Carbopol 934 was chosen as the vehicle, and the amount of bleomycin release from the preparation increased remarkable with an increase in concentration of hydroxypropyl cellulose. In contrast, the water-absorbing property increased with an increase of Carbopol 934.

Le joyeux et al. (1989) developed a bioadhesive tablet of metronidazole for oral or vaginal administration, containing 50% drug, 37.5% hydroxypropyl cellulose and 12.5% Carbopol 934P. The tablets were 12 mm in diameter and 2 mm thick. It seems that the presence of a large quantity of mucus at the interface protects the bioadhesive system from the effects of the surrounding medium.

Genc, Oguzlar, and Guler (2000) developed bioadhesive vaginal tablets containing acyclovir which were prepared using poly(acrylic acid), methylcellulose, carboxymethylcellulose, hydroxypropyl cellulose and hydroxypropyl methylcellulose as bioadhesive polymers in different concentrations by direct compression technique and wet granulation technique. Swelling of the tablets containing hydroxypropyl cellulose, carboxymethylcellulose, and methylcellulose were very rapid and caused disintegration of tablets. The swelling behavior of the tablets containing hydroxypropyl methylcellulose lasted 6 hours in lactic solution. The force necessary to detach the tablets from the vaginal tissue was found to depend on concentration and

type of the bioadhesive polymer. The tablets containing hydroxypropyl methylcellulose needed the most detachment force.

Rectal Administration

Leede et al. (1986) proposed cylindrical hydrogels using hydroxyethyl methacrylate (HEMA) and ethylene glycol dimethacrylate (EGDMA) as crosslinking agents including antipyrine and theophylline as model drugs for rectal administration.

Dash et al. (1999) developed a rectal nicotine delivery system with bioadhesive for the treatment of ulcerative colitis. Rectal nicotine suppository formulations were prepared in semi-synthesis glyceride base (Suppocire AM, and AI) By fusion method using glyceryl monooleate and carbopol as bioadhesives. In vitro release indicated that the low melting AI base was superior to that of the AM base. Presence of glyceryl monooleate was in the formulation enhanced the release of nicotine whereas Carbopol showed an opposite effect. The enhanced release of nicotine in the presence of glyceryl monooleate was found to be partly due to the melting point lowering effect of this compound. Caco-2 cell absorption studies showed that there was a decrease in the flux of nicotine in the presence of both bioadhesives. The flux of the fluorescein marker which is used to study the integrity of the cell monolayers was found to be slightly higher only the presence of 10%.

Intraoral Administration

Ishida et al. (1981) developed insulin mucoadhesive tablet to solve the problems of the administration of insulin by injection. A mixture of hydroxypropyl cellulose and Carbopol 934 was used in this new form. Unfortunately, the percentage of insulin absorbed from this dosage form was about 0.5% compared with the amount absorbed through intramuscular injection of insulin.

Ishida, Nambu, and Nagai (1982) developed lidocaine mucoadhesive tablets for toothaches. This preparation contained lidocaine, hydroxypropyl cellulose and Carbopol 934 by freeze dried technique. This dosage form could afford a prolonged local anesthetic action.

Bremecker, Stempel, and Klein (1983) prepared a novel mucoadhesive ointment based partly on neutralized polymethacrylic acid methyl ester. The flow curves of the ointment vehicle showed pseudoplastic properties. The rheological behavior as well as the adhesion on the mucosal membrane could varied by the type and concentration of the polymer used and the base used for neutralization. During clinical studies, the ointment vehicle as well as a tretionin (vitamin A acid) preparation for the treatment of lichen planus did not cause any local irritation or systemic side effects. Both vehicle and preparation were found to be pleasant for patient to use.

Schor et al. (1983) developed nitroglycerin mucoadhesive tablet consisted of polymers made from naturally occurring materials (Synchron[®]) which can be mixed directly with an active pharmaceutical substance and directly compressed into tablet for the treatment of angina pectoris. The buccal tablet was quite small so that it would adhere to the buccal mucosa and not require adhesives to hold it in place. The tablet completely dissolved over a period of hours to produce a steady, high level of clinical activity over a period of 5 to 6 hours.

Nagai and Machida (1985) developed triamcinolone tablet for the treatment of aphthous stomatitis. The dosage form is a double layered tablet of small dimensions. The upper coloured layer was lactose and has no adhesive properties. Its role is to permit drug diffusion out of its activity site and to allow an easy placing of the bioadhesive tablet. The lower layer contains the active ingredient and the mucoadhesive polymer hydroxypropyl cellulose and Carbopol 934. It is commercially available in Japan under the name of 'Aftach'.

Yotsoyanagai et al. (1985) designed a mucoadhesive using moderately water soluble polymer films containing analgesics and antibiotics for pain relief and which aids in the healing of lesions. The film consisted of hydroxypropyl cellulose containing tetracaine, thiamphenical and triacetin.

Anders and Merkle (1989) developed the bioadhesive patches for buccal administration of protirelin, consisting of two-ply laminates of an impermeable backing layer and a hydrocolloid polymer layer containing the drug. The polymers used were hydroxyethylcellulose, poly(vinylpyrrolidone), hydroxypropyl cellulose,

and poly(vinylalcohol). The duration of mucosal adhesion in vivo is affected by the type of polymer used, its viscosity grade, the polymer load per patch, and the drying procedure for preparation. A wide range of drug release rates can be achieved by varying these parameter. Drug release rates are controlled by polymer dissolution kinetics.

Deasy and O'Neill (1989) prepared timolol bioadhesive dosage form. A final compact containing a core of timolol base and precirol, a bioadhesive layer of Carbopol and hydroxypropyl cellulose, and a cap of magnesium stearate gave sustained release of the drug in the simulated saliva pH 6.6 (Figure 7).

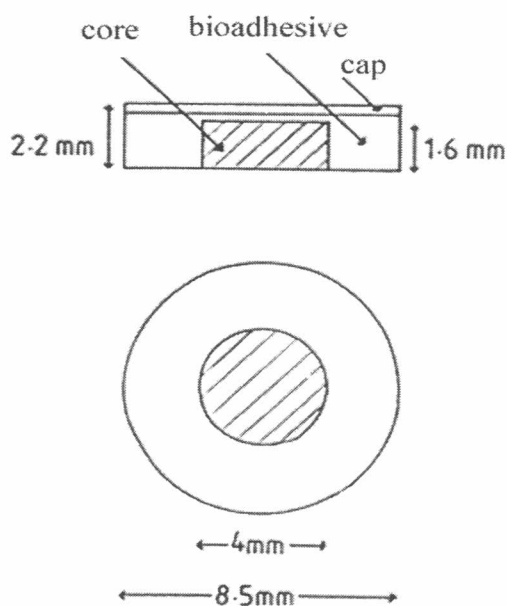

Figure 7 Bioadhesive device (Deasy and O'Neill, 1989)

Collins and Deasy (1990) developed cetylpyridinium chloride mucoadhesive lozenge for treatment oral infection. It was a three-layered device. Using Carbopol 934 and hydroxypropyl cellulose as mucoadhesive polymers. The device offered considerable improvement over the proprietary product in sustaining salivary levels of drug in the therapeutic range.

Bottenberg (1991) developed fluoride mucoadhesive tablet for prevention of dental caries. As recent studies have shown that fluoride is effective in small concentrations when it is present long enough in the fluid surrounding the enamel; an oral slow-release fluoride administration seems to be the method of choice. The experiment concluded that bioadhesive polymer such as choice. The experiment concluded that bioadhesive polymers such as thermally modified corn starch with 5% Carbopol 934 or polyethylene glycol (MW 300,000) could be used as a slow-release tablet offered an effective way of sustaining a fluoride level in saliva in vivo.

Agarwal et al. (1993) developed tetracycline-poly(lactide/glycolide) films for the treatment of periodontitis. In vitro release showed that both the rate and percent of drug released increased as drug loading and dissolution media pH increased. Linear relationships obtained for graphs of the percent released versus both the square root time and drug loading indicated a matrix-controlled release from a porous, granular, monolithic system. Preliminary results from a clinical study with 8 periodontal, maintenance patients indicate that films containing 25% w/w tetracycline HCl were effective in decrease bacterial count in the intra-crevicular fluid and demonstrated a significant microbial inhibition for two week over the control placebo film. The decrease in tetracycline HCl concentration in the gingival fluid was approximated by the first order relationship with the tetracycline HCl disappearance rate constant of 0.19 day^{-1} .

Guo (1994) prepared buprenorphine bioadhesive buccal patches which consisting of polyisobutylene, polyisoprene, and Carbopol®934P. The patch was prepared by using two-roll milling method. Nearly 75% of the drug was related from the patches following a 24 hours incubation in phosphate buffer (pH=7). The major mechanism of drug release is patch swelling. It also shown that patch adhesion increased with increasing thickness and up to three months of aging had little effect on adhesive properties. In addition, this formulation maintained the majority of its adhesive strength for at least 24 hours with linear decline in average peeling load thereafter.

Save and Venkitachalam (1994) developed nifedipine buccoadhesive tablet using sodium alginate as the bioadhesive polymer. Mennitol, lactose, polyethylene

glycol 6000 and polyethylene glycol 4000 were incorporated as solubilizers, singly or in combination. These tablets exhibited rapid *in vitro* release.

Miyazaki et al. (1994) prepared ketoprofen bioadhesive tablets using chitosan and sodium alginate as adhesive polymers. The adhesion and release characteristics of the prepared systems were evaluated *in vitro* and *in vivo*. The magnitudes of the adhesion force of chitosan/alginate tablets were observed to be comparable to that of AftachTM, which is a typical commercial preparation of an oral mucoadhesive tablet. Increasing the chitosan content in the tablets resulted in decrease in the release rate of ketoprofen. When the tablets were administration to the sublingual site of rabbits, ketoprofen was rapid absorbed. Furthermore, the plasma concentration curves for tablet with a 1:4 chitosan/alginate ratio showed a sustained release 3 hours after administration. The suggested that the tablets prepared from chitosan and alginate are potential candidates for intraoral drug delivery.

Danjo, Higuchi, and Otsuka (1995) investigated the *in vitro* drug release for mixed polymer films using lidocaine, which is poorly water-soluble. The mixed polymers films consisted of various ratios of hydroxypropyl cellulose and hydroxypropyl methylcellulose phthalate. The results indicated that glycyrrhizic acid enhanced the dissolution rate of lidocaine from mixed polymer films, which may be due to the formation of an amorphous state. And polyethylene glycol enhanced wettability of the polymer by the buffer solution may have caused the increased dissolution rate.

Voorspoels et al. (1996) studied in buccal absorption of testosterone and its esters using a bioadhesive tablets which was used in order to sustain the delivery and bypass the liver. The *in vitro* detachment force decreased with an increasing amount of testosterone and for an increasing chain length of the esters, except in the case of testosterone enanthate. The *in vivo* results revealed that the bioavailability of testosterone was significantly higher than that of the esters, which is probably due to the lower solubility of the esters. The buccal administration of testosterone via the bioadhesive tablet allowed the maintenance of the plasma level at above 3 ng/ml for 15 to 24 hours.

Burgalassi et al. (1996) prepared benzydamine and lidocaine mucoadhesive buccal patches. The drug were used as hydrochloride, or, to reduce their solubility and improve their release characteristics, as salts with pectin or polyacrylic acid. The patches, which prepared by compressing appropriate mixtures containing the drug salts/complexes, lactose and tamarind gum, were tested in vitro for mucoadhesion and drug release, and in vivo on human volunteers for retention and release of benzocaine. The devices containing the salts of benzocaine with pectin and polyacrylic acid, and the complex of lidocaine with tannic acid showed zero-order release kinetics in vitro. The patches adhered for over 8 hours to the upper gums of the volunteers, and were perfectly tolerated. Benzocaine hydrochloride was released in vivo and in vitro with practically identical profiles.

Parodi et al. (1996) developed a buccoadhesive system for delivery of oxycodone hydrochloride which prepared from a colloidal solution of gelatin used as bioadhesive agent. The oxycodone hydrochloride release from the studied matrix of gelatin appears to occur by swelling-controlled mechanism. This formulation shows significant bioadhesive properties and could be useful for buccal administration of oxycodone hydrochloride.

- Jones et al. (1996) developed a bioadhesive semi-solid, polymeric systems containing tetracycline for treatment of periodontal diseases which using hydroxyethylcellulose, polyvinylpyrrolidone, and polycarbophil as bioadhesive polymers. The drug release from all formulations was zero-order. Increased concentration of hydroxyethylcellulose decreased the rate of release of drug, due to the concomitant increase in product viscosity and subsequent decreased rate of penetration of dissolution fluid into the formulation. Conversely, an increased polyvinylpyrrolidone concentration increased drug release rates, due to an increased formulation porosity following dissolution of this polymer.

Kohda et al. (1997) developed lidocaine hydrochloride controlled release mucoadhesive films with solid dispersion that were using ethylcellulose and hydroxypropylcellulose as adhesive polymers. These observed will provide useful information on clinical application.

Taware et al. (1997) studied in lidocaine hydrochloride bioadhesive system. The subjective evaluation revealed that the drug delivery system adheres to the gingiva within a minute and produces peak effect in 15 minutes. Comparative study revealed that the drug delivery system produces greater depth of anesthesia than the marketed topical gel.

Shojaei, Zhou, and Li (1998) designed a buccal mucoadhesive system for delivery of acyclovir using mucoadhesive copolymers of acrylic acid and poly(ethylene glycol). Buccal permeation of acyclovir from mucoadhesive delivery system was controlled for up to 20 hours with the time lag of 10.4 hours and steady state flux of $144.2 \mu\text{g}/\text{cm}^2/\text{h}$. With the incorporation of sodium glycolate into the system lag-time was shortened to 5.6 hours with an enhanced steady state flux of $758.7 \mu\text{g}/\text{cm}^2/\text{h}$. Sustained delivery of acyclovir across buccal mucosa using this mucoadhesive system was maintained for up to 22 hours.

Dortunc, Ozer, and Uyanik (1998) developed Pindolol buccoadhesive tablets which were prepared for avoidance of hepatic first-pass metabolism. Carbopol 934 and sodium carboxymethylcellulose were used as bioadhesive polymers and Methocel K4M, Methocel K15M, and hydroxypropyl cellulose were added as matrix-forming polymers. The mixture of Carbopol 60%w/w and Methocel K4M or Methocel K15M 30%w/w were found the best formulation. These matrices had good bioadhesive properties and released 95-96% of their pindolol content over a period of 10 hours.

Senel et al. (2000) prepared chitosan films and hydrogels for local delivery of chlorhexidine gluconate to the oral cavity. The release of the drug from gels was maintained for 3 hours. A prolonged release was observed with film formulations. No lag-time was observed in release of the drug from either gels or films. The highest antifungal activity was obtained with 2% chitosan gel containing 0.1% chlorhexidine gluconate.

Yong et al. (2001) prepared omeprazole buccal adhesive tablet with various bioadhesive polymers, alkali materials, and croscarmellose sodium. As bioadhesive additives for the omeprazole tablet, a mixture of sodium alginate and hydroxypropyl methylcellulose was selected. The omeprazole tablets prepared with bioadhesive polymers alone had bioadhesive force suitable for buccal adhesive tablet, but the

stability of omeprazole in human saliva was not satisfactory. Among alkali materials, only magnesium oxide could be an alkali stabilizer for omeprazole buccal adhesive tablets due to its strong waterproofing effect. Croscarmellose sodium enhanced the release of omeprazole tablets. However, it decreased the bioadhesive forces and stability of omeprazole tablets in human saliva. The tablet composed of omeprazole/ sodium alginate/ hydroxypropyl methylcellulose/ magnesium oxide/ croscarmellose sodium (20/24/6/50/10 mg) could be attached on the human cheek without disintegration, and it enhanced the stability of omeprazole in human saliva for at least 4 hours and gave fast release of the drug.

2.10 Mechanical Properties of Film (Aulton and Abdul-Razzak, 1981)

The elasticity and tensile strength of the various films can be evaluated by using a tensile-strength tester. The tensile testing process is to apply increasing tensile load at a constant rate to a film strip which know dimensions in the dimension perpendicular to the cross-section of the film strip until the failure takes place. The load at film failure will be measured in term of force per unit cross-section area of the film. Polymers are divided into five categories according to a qualitative description of their mechanical behavior and corresponding stress-strain characteristics as showed in the Table 1 and Figure 8.

Table 1 Qualitative description of polymer and it's stress-strain characteristics

Polymer Description	Characteristics of stress-strain curve			
	Young's Modulus	Yield Stress	Tensile Strength	Elongation to Break
Soft, weak	Low	Low	Low	Low to modulate
Soft, tough	Low	Low	Moderate	Very high (20-100%)
Hard, brittle	High	None	Moderate to high	Very low (<2%)
Hard, strong	High	High	High	Moderate (~5%)
Hard, tough	High	High	High	High

Hard or stiff polymers are characterized by high moduli as opposed to soft ones. Strong (as opposed to weak) polymers have high tensile strengths. Tough (as opposed to brittle) polymers have large area under their stress-strain curves and require large amounts of energy to break under stress, combining high or at least modulate tensile strength with high elongation. The desirable hard, tough film must have a high yield stress large extension before breaking and high elastic modulus.

A typical stress-strain curve is shown in Figure 8. The ultimate tensile strength or breaking stress is the maximum applied at which the film breaks. Stress is calculated by dividing force by original cross-sectional area. Elongation or strain at break is a measure of the ductility of the films. Strain in tension called elongation. It is calculated by dividing the increase in length by original length. Elastic modulus or Young's modulus is the most basic and "structurally important of all mechanical properties and is a measure of the stiffness and rigidity of the film. It is calculated as applied stress divided by the corresponding strain in the region of linear elasticity. Area under curve is a function of the work done in breaking the film and is representative of the film's toughness. The energy to break per unit area is calculated by dividing the area under curve by the volume of the specimen between the clamps.

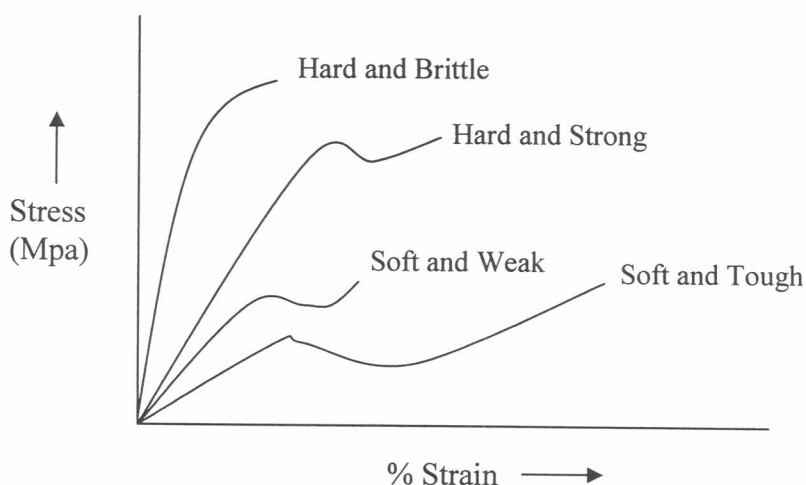

Figure 8 Characteristic of polymer properties in stress-strain curves

Physicochemical Properties of Triamcinolone Acetonide

1. Chemical name

9 α -Fluoro-11 β ,21-dihydroxy-16 α ,17 α -isopropylidenedioxypregna-1,4-diene-3,20-dione

2. Molecular formula

C₂₄H₃₁FO₆

3. Molecular weight

434.5

4. Chemical structure

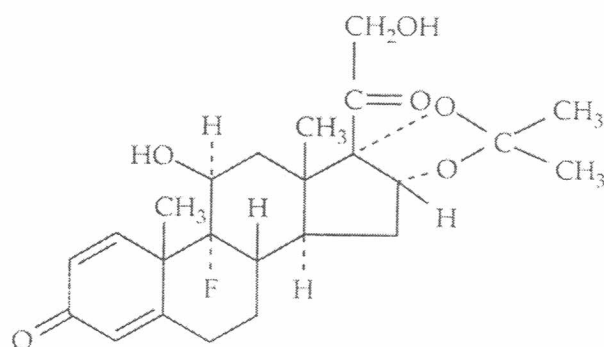

5. Appearance

Triamcinolone acetonide is a white or cream crystalline powder, almost odorless.

6. Solubility

Triamcinolone acetonide is sparingly soluble in chloroform and in ethanol, very slightly soluble in ether, practically insoluble in water.

7. Melting point

Triamcinolone acetonide melt at about 292-294 °C

Physicochemical Properties of Miconazole Nitrate

1. Chemical name

1*H*-Imidazole,1-{2-(2,4-dichlorophenyl)-2-[(2,4-dichlorophenyl) methoxy]ethyl}-,mononitrate

2. Molecular formula

$C_{18}H_{14}Cl_4N_2O \cdot HNO_3$

3. Molecular weight

479.15

4. Chemical structure

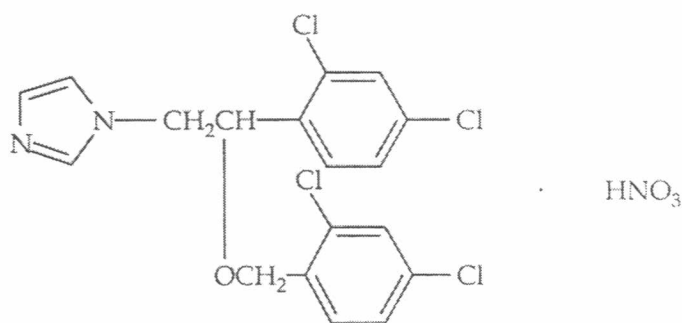

5. Appearance

Miconazole nitrate is a white or almost white, crystalline or microcrystalline powder, odorless or almost odorless.

6. Solubility

Miconazole nitrate is freely soluble in methyl alcohol, slightly soluble in alcohol, very slightly soluble in water and in ether.

7. Melting point

Miconazole nitrate melt at about 178-184 °C