

การออกแบบระบบการหมุนเวียนสำหรับกระบวนการทำความสะอาดภายในถังเก็บนมพาสเจอร์ไรส์

นายบุษกมล ศิริบุรานนท์

วิทยานิพนธ์นี้เป็นส่วนหนึ่งของการศึกษาตามหลักสูตรปริญญาวิศวกรรมศาสตรมหาบัณฑิต

สาขาวิชาวิศวกรรมเคมี ภาควิชาวิศวกรรมเคมี

คณะวิศวกรรมศาสตร์ จุฬาลงกรณ์มหาวิทยาลัย

ปีการศึกษา 2550

ลิขสิทธิ์ของจุฬาลงกรณ์มหาวิทยาลัย

DEVISE OF A CLEANING IN PLACE (CIP) WITH CIRCULATION PROCESS IN A  
PASTEURIZED MILK TANK

Mr. Butsakon Siriburanon

A Thesis Submitted in Partial Fulfillment of the Requirements  
for the Degree of Master of Engineering Program in Chemical Engineering

Department of Chemical Engineering

Faculty of Engineering

Chulalongkorn University

Academic Year 2007

Copyright of Chulalongkorn University

Thesis Title                            DEVISE OF A CLEANING IN PLACE (CIP) WITH  
CIRCULATION PROCESS IN A PASTEURIZED  
MILK TANK

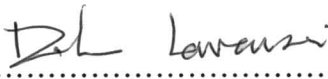
By    Mr. Butsakon Siriburanon

Field of Study                            Chemical Engineering


Thesis Advisor                         Associate Professor Paisan Kittisupakorn, Ph.D.

---


Accepted by the Faculty of Engineering, Chulalongkorn Univesity in  
Partial Fulfillment of the Requirements for the Master's Degree

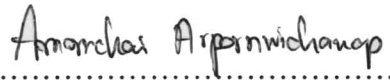
  
..... Dean of the Faculty of Engineering  
(Professor Direk Lavansiri, Ph.D.)

#### THESIS COMMITTEE

  
..... Chairman  
(Associate Professor Tharathon Mongkhonsi, Ph.D.)

  
..... Thesis Advisor  
(Associate Professor Paisan Kittisupakorn, Ph.D.)

  
..... Member  
(Assistant Professor Wirat Vanichsiratana Ph.D.)

  
..... Member  
(Amornchai Arpornwichanop, D.Eng.)

บุษกมล ศิริบุรานนท์ : การออกแบบระบบการหมุนเวียนสำหรับกระบวนการทำความสะอาดใน  
ถังเก็บนมพาสเจอร์ไรส์ (DEVISE OF A CLEANING IN PLACE (CIP) WITH A  
CIRCULATION PROCESS IN A PASTEURIZED MILK TANK) อ. ที่ปรึกษา: รศ.ดร. ไพศาลกิตติศุกร;  
138 หน้า.

กระบวนการทำความสะอาด CLEANING IN PLACE (CIP) เป็นกระบวนการทำความสะอาดภายในเครื่องจักร อุปกรณ์ และระบบท่อในระบบการผลิตซึ่งถูกใช้อย่างกว้างขวางในอุตสาหกรรมการผลิตอาหารและเครื่องดื่มเนื่องจากมีความสะดวกรวดเร็ว และมีประสิทธิภาพในการทำทำความสะอาดโดยไม่ต้องมีการรื้อถอน อย่างไรก็ตาม ถึงแม้ว่าโครงสร้างการของกระบวนการทำความสะอาด CIP ได้ถูกพัฒนารูปแบบเพื่อให้มีความประหยัดมากขึ้นอย่างต่อเนื่องเพื่อลดปริมาณการใช้สารเคมีและน้ำ ในการปฏิบัติงานจริงพบว่ายังมีการใช้สารเคมีและน้ำในปริมาณมากซึ่งเกิดจากหลายๆสาเหตุ งานวิจัยนี้ได้ทำการศึกษาพฤติกรรม และหารูปแบบและอัตราการใช้สารที่เหมาะสมสำหรับกระบวนการทำความสะอาด CIP ในโรงงานนม การได้มาซึ่งค่าที่เหมาะสมจำเป็นต้องทำการหาแบบจำลองทางคณิตศาสตร์ของกระบวนการทำความสะอาด CIP ซึ่งข้อมูลที่ใช้ในการหาแบบจำลองได้มาจากการเก็บข้อมูลการทำงานจริงในโรงงานและการทดลอง การศึกษาแบบจำลองทางคณิตศาสตร์ของกระบวนการทำความสะอาด CIP ทำให้ทราบการเปลี่ยนแปลงแบบพลวัตของความเข้มข้นของสารเคมีทำความสะอาดและปริมาณสารเจือปน ปัญหาการหาสถานะที่เหมาะสมถูกกำหนดและทำการหาคำตอบโดยใช้โปรแกรม MATLAB

จากผลการเก็บข้อมูลจากการทดลองพบว่าสารเคมีเบสและกรดที่ใช้ในการทำความสะอาดสามารถนำกลับมาใช้ใหม่ได้ ซึ่งจากผลการหาค่าสถานะที่เหมาะสมพบว่าอัตราการใช้สารที่เหมาะสมที่สุดเท่ากับ 4.34% และ 1.70% ด้วยอัตราการใช้สารทุกๆ 2 และ 3 รอบการทำความสะอาดหลังจากการใช้งาน 1 สัปดาห์สำหรับขั้นตอนการทำความสะอาดด้วยเบสและกรดตามลำดับ

ภาควิชา...วิศวกรรมเคมี.....

สาขาวิชา...วิศวกรรมเคมี...

ปีการศึกษา 2550

ลายมือชื่อนิสิต..... *บุษกมล ศิริบุรานนท์* .....

ลายมือชื่ออาจารย์ที่ปรึกษา..... *ไพศาลกิตติศุกร* .....

## 4770332621 : MAJOR CHEMICAL ENGINEERING

KEY WORD : ALKALI AND ACID CLEANING /CIP PROCESS /DAIRY PLANT/  
OPTIMIZATION / OPTIMAL DRAINING RATIO

BUTSAKON SIRIBURANON : DEVISE OF A CLEANING IN PLACE (CIP)  
WITH CIRCULATION PROCESS IN A PASTEURIZED MILK TANK.  
THESIS ADVISOR : ASSOC. PROF. PAISAN KITTISUPAKORN, Ph.D.  
138 pp.

Cleaning In Place (CIP), one of cleaning processes which is widely used in most food and beverage industrials, has been applied to clean raw materials and products remained in storage tanks, pipe lines and equipment because the CIP process provides reliable, fast and efficient cleaning without dismantling equipment. Although, the CIP cleaning process have been developed continuously to increase chemical and water saving, the real operations of these processes still have been considered as a large amount consumed water processes. This work studies process behaviors and optimizes to determine optimal draining ratio of the CIP cleaning chemicals in a dairy plant. To achieve these, mathematical models of the CIP process have been developed and data have been gathered from real plant. With these models, simulation study has been carried out to find out the dynamic behavior of the process with respect to the concentrations and contaminations in cleaning chemicals. The optimization problem has been formulated and solved using written programs based on MATLAB application program.

According to the microbial data result, the used cleaning detergent, alkaline and acid, can be recycled. In the optimization approach, the optimal draining ratios have been obtained as 4.34% and 1.70% with 2 and 3 cycles/time draining time after 1 week pass for alkaline and acid respectively.

Department:...Chemical Engineering.....

Field of Study:...Chemical Engineering...

Academic Year: 2007

Student's Signature: *Butsakon Siriburanon*

Advisor's Signature: *Paisan Kittisupakorn*

## **ACKNOWLEDGEMENTS**

First of all, I would like to express my gratitude to my thesis advisor, Associate Professor Dr. Paisan Kittisupakorn, for his valuable suggestion and encouraging guidance. Furthermore, I am also grateful to Associate Professor Dr. Tharathon Mongkhonsi as the chairman of thesis committee, Assistant Professor Dr. Wirat Vanichsriratana and Dr. Amornchai Arpornwichanop as the members of thesis committee for many valuable suggestions.

Special thanks go to the Thailand research fund-master research grants (TRFMAG) for financial support of this research.

I am also thanks to all my friends, process control laboratory members, and supporting colleagues, Santiphan Taweehirunsuwan and Sithichai Udsawamekmanee, for their friendship and assistance.

Most of all, I would like to express the highest gratitude to my parents, and all of family for their love, inspiration, encouragement and financial support throughout this study.

# CONTENTS

	Page
Abstract in Thai.....	iv
Abstract in English.....	v
Acknowledgements.....	vi
Contents.....	vii
List of Tables.....	ix
List of Figures.....	xi
Nomenclature.....	xvii
 CHAPTER	
I Introduction.....	1
1.1 Motivation.....	1
1.2 Research Objective.....	2
1.3 Scope of Research.....	2
1.4 Procedure Plan.....	3
II Literature Reviews.....	5
2.1 Development of Technology involving with CIP process.....	5
2.2 Optimization.....	7
III Theoretical Background.....	10
3.1 Cleaning in Place (CIP) process.....	10
3.2 Model of CIP process.....	17
3.3 Optimization.....	26
3.4 Sequential quadratic programming.....	28

CHAPTER	Page
IV Research Methodology.....	34
4.1 Cleaning In Place Process in Dairy Plant.....	34
4.2 Model of Cleaning In Place Process in Dairy Plant.....	42
4.3 Data Collection.....	44
4.4 Optimization.....	51
V Research Result.....	55
5.1 Model of Cleaning In Place Process in the Dairy Plant.....	55
5.2 Optimization.....	73
VI Conclusions and Recommendations.....	115
6.1 Conclusions.....	115
6.2 Recommendation.....	118
References.....	119
Appendices.....	124
Appendix A : Data Collection.....	125
Appendix B: Microbial Growth.....	131
Appendix C: Standard plate count method.....	136
Vita.....	138



## LIST OF TABLES

TABLE	Page
5.1 The result of standard plate count for alkaline detergent in regular capacity operation day (pilot plant).....	58
5.2 The result of standard plate count for alkaline detergent in regular capacity operation day (real plant).....	59
5.3 The result of standard plate count method for alkali detergent in non-operation day.....	59
5.4 The result of standard plate count for acid detergent in regular capacity operation day.....	60
5.5 The result of standard plate count method for acid detergent in non-operation day.....	60
5.6 Parameters and initial conditions of the plant cleaning operation.....	62
5.7 The average values of remaining volume of the residual water in each steps.....	62
5.8 The parameters of the compartment models.....	70
5.9 Summary and comparison of consumptions between the plant actual method and the offered method with the optimal draining ratio of CIP alkali cleaning step.....	75
5.10 Summary and comparison of consumptions among the various applied draining ratios of CIP alkali cleaning step.....	80
5.11 Optimal draining ratio (%) in the conditions of different initial concentrations and contaminations.....	83

TABLE	Page
5.12 Minimum concentration (% $\cdot$ g/mL.) in the conditions of different initial concentrations and contaminations.....	84
5.13 Maximum contamination (g/L.) in the conditions of different initial concentrations and contaminations.....	85
5.14 Chemical saving (%) in the conditions of different initial concentrations and contaminations.....	86
5.15 Water saving (%) in the conditions of different initial concentrations and contaminations.....	87
5.16 Summary and comparison of consumptions between the plant actual method and the offered method with the optimal draining ratio of CIP acid cleaning step.....	96
5.17 Summary and comparison of consumptions among the various applied draining ratios of CIP acid cleaning step.....	100
5.18 Optimal draining ratio (%) in the conditions of different initial concentrations and contaminations.....	104
5.19 Minimum concentration (% $\cdot$ g/mL.) in the conditions of different initial concentrations and contaminations.....	105
5.20 Maximum contamination (g/L.) in the conditions of different initial concentrations and contaminations.....	106
5.21 Chemical saving (%) in the conditions of different initial concentrations and contaminations.....	107
5.22 Water saving (%) in the conditions of different initial concentrations and contaminations.....	108

## LIST OF FIGURES

FIGURE	Page
3.1 Cleaning passages of CIP process in non-circulative (a) and circulative (b) cleaning.....	10
3.2 Centralized CIP system.....	12
3.3 Decentralized CIP system.....	13
3.4 Cleaning steps of general CIP process.....	14
3.5 Circulative system of chemical cleaning process.....	18
3.6 Well-mixed CSTR model.....	19
3.7 CSTR with bypass and dead region of the real reactor (a) and the compartment model (b).....	21
3.8 Two tanks circulative model.....	23
3.9 Two tanks circulative compartment model.....	23
3.10 Classification of optimization.....	27
3.11 Flowchart of SQP algorithm.....	33
4.1 Pasteurized milk process.....	35
4.2 Pasteurization and homogenization sub-procedure.....	35
4.3 Milk receiving step.....	36
4.4 Heat exchanger used in pasteurization process.....	36
4.5 Homogenizer.....	36
4.6 Pasteurized milk tanks.....	37
4.7 Packing machines.....	37
4.8 CIP station.....	37
4.9 Cleaning steps of CIP process before the production start.....	38

FIGURE	Page
4.10 Cleaning steps of CIP process after the end of production .....	39
4.11 Flow diagram of chemicals during CIP cleaning operations .....	40
4.12 Material balance of alkaline around alkaline and acid tanks .....	41
4.13 Flow diagram of process .....	42
4.14 Sampling position in chemical tanks .....	45
4.15 Sample collections from (a) chemical surface and middle of detergent height and (b) at the tank bottom .....	45
4.16 Sampling for microbial quality testing in the standard plate count method .....	47
4.17 CIP invented pilot plant .....	48
4.18 Chemical heating in CIP pilot plant .....	49
4.19 Solution circulating when operating circulative cleaning in the CIP pilot plant .....	50
5.1 Concentration of alkaline detergent during 10 minutes milk tanks and packing machines cleaning after the production. ....	55
5.2 Concentration of acid detergent during 10 minutes packing machines cleaning before the production and milk tanks and packing machines after the production. ....	56
5.3 Contamination of alkaline detergent during 10 minutes pasteurized milk tanks and packing machines cleaning after the production. ....	57

FIGURE	Page
5.4 Contamination of acid detergent during 10 minutes packing machines cleaning before the production and milk tanks and packing machines after production.....	57
5.5 Modeling by the compartment model with $\beta = 0.78$ of concentration of alkaline detergent during 1 cycle milk tanks cleaning after production.....	64
5.6 Modeling by the compartment model with $\beta = 0.37$ of concentration of alkaline detergent during 1 cycle packing machines cleaning after production.....	64
5.7 Modeling by the compartment model with $\beta = 0.26$ of concentration of acid detergent during 1 cycle packing machines cleaning before production.....	65
5.8 Modeling by the compartment model with $\beta = 0.70$ of concentration of acid detergent during 1 cycle milk tanks cleaning after production.....	65
5.9 Modeling by the compartment model with $\beta = 0.44$ of concentration of acid detergent during 1 cycle packing machines cleaning after production.....	66
5.10 Modeling by the compartment model with $\beta = 0.78$ and $\mu = 0.13$ of contamination of alkaline detergent during 1 cycle milk tanks cleaning after production.....	67

FIGURE	Page
5.11 Modeling by the compartment model with $\beta = 0.37$ and $\mu = 0.41$ of contamination of alkaline detergent during 1 cycle packing machines cleaning after production.....	67
5.12 Modeling by the compartment model with $\beta = 0.26$ and $\mu = 0.55$ of contamination of acid detergent during 1 cycle packing machines cleaning after production.....	68
5.13 Modeling by the compartment model with $\beta = 0.70$ and $\mu = 0.05$ of contamination of acid detergent during 1 cycle milk tanks cleaning after production.....	68
5.14 Modeling by the compartment model with $\beta = 0.44$ and $\mu = 0.10$ of contamination of acid detergent during 1 cycle packing machines cleaning after production.....	69
5.15 Concentration and contamination of alkali during two days (Four cleaning cycles).....	70
5.16 Concentration and contamination of acid during two days (Six cleaning cycles).....	71
5.17 Concentration and contamination of alkali cleaning and draining ratio for the actual method.....	71
5.18 Concentration and contamination of acid cleaning and draining ratio for the actual method .....	72
5.19 Concentration and contamination of alkali detergent when applying the offered method with 4.34% draining ratio .....	75

FIGURE	Page
5.20 Concentration and contamination of alkali detergent when applying 10% draining ratio and draining pattern 2 cycles/time after 1 week pass.....	76
5.21 Concentration and contamination of alkali detergent when applying 16.67% draining ratio and draining pattern 2 cycles/time after 1 week pass.....	77
5.22 Concentration and contamination of alkali detergent when applying 20% draining ratio and draining pattern 2 cycles/time after 1 week pass.....	77
5.23 Concentration and contamination of alkali detergent when applying 30% draining ratio and draining pattern 2 cycles/time after 1 week pass.....	78
5.24 Concentration and contamination of alkali detergent when applying 40% draining ratio and draining pattern 2 cycles/time after 1 week pass.....	78
5.25 Concentration and contamination of alkali detergent when applying 50% draining ratio and draining pattern 2 cycles/time after 1 week pass.....	79
5.26 Alkali saving (a), water saving (b) and average alkali contaminations after 1 week (c) at the various draining ratios with the draining pattern 2 cycles/time after 1 week pass.....	81
5.27 Optimal draining ratios (%) (a), minimum concentrations (% <sub>w</sub> ,g/mL.) (b), maximum contaminations (g/L.) (c), alkaline saving (%) (d) and water saving (%) (e) in the conditions of different initial concentrations and contaminations.....	92
5.28 Concentration and contamination of acid detergent when applying the offered method with 1.70% draining ratio.....	95
5.29 Concentration and contamination of acid detergent when applying 10% draining ratio and draining pattern 3 cycles/time after 1 week pass.....	97

FIGURE	Page
5.30 Concentration and contamination of acid detergent when applying 16.67% draining ratio and draining pattern 3 cycles/time after 1 week pass.....	97
5.31 Concentration and contamination of acid detergent when applying 20% draining ratio and draining pattern 3 cycles/time after 1 week pass.....	98
5.32 Concentration and contamination of acid detergent when applying 30% draining ratio and draining pattern 3 cycles/time after 1 week pass.....	98
5.33 Concentration and contamination of acid detergent when applying 40% draining ratio and draining pattern 3 cycles/time after 1 week pass.....	99
5.34 Concentration and contamination of acid detergent when applying 50% draining ratio and draining pattern 3 cycles/time after 1 week pass.....	99
5.35 Acid saving (a), water saving (b) and average acid contaminations after 1 week (c) at the various draining ratios with the draining pattern 2 cycles/time after 1 week pass.....	102
5.42 Optimal draining ratios (%) (a), minimum concentrations (% <sub>w</sub> ,g/mL.) (b), maximum contaminations (g/L.) (c), alkaline saving (%) (d) and water saving (%) (e) in the conditions of different initial concentrations and contaminations.....	113



## NOMENCLATURES

### Process Model

$C_c$	Chemical concentration in the CIP chemical tank	%[mass/volume]
$C_{ci}$	Initial chemical concentration	%[mass/volume]
$C_{cf}$	Final chemical concentration	%[mass/volume]
$C_e$	Chemical concentration in process equipment	%[mass/volume]
$C_{ic}$	Chemical concentration of the CIP tank inlet flow	%[mass/volume]
$C_{ie}$	Chemical concentration of the equipment inlet flow	%[mass/volume]
$C_{oc}$	Chemical concentration of the CIP tank outlet flow	%[mass/volume]
$C_{oe}$	Chemical concentration of the equipment outlet flow	%[mass/volume]
$C_{target}$	Target concentration for chemicals adding and preparing	%[mass/volume]
$F_{ic}$	Inlet flowrate of the CIP tank	L/min
$F_{ie}$	Inlet flowrate of the equipment	L/min
$F_{oc}$	Outlet flowrate of the CIP tank	L/min
$F_{oe}$	Outlet flowrate of the equipment	L/min
$N$	Number of counted microbial by the SPC method	cfu
$N_c$	Microbial number in the CIP chemical tank	cfu
$N_{ci}$	Initial number of microbial	cfu
$N_{cf}$	final number of microbial	cfu
$R$	Microbial remaining after cleaning operation	%
$T$	Time duration of a cleaning cycle	min
$V_c$	Volume of chemical in the CIP chemical tank	L.
$V_e$	Volume of remaining water in the equipment	L.
$X_c$	Chemical contamination in the CIP chemical tank	g/L
$X_{ci}$	Initial chemical contamination at any cycle	g/L
$X_{cf}$	Final chemical contamination at any cycle	g/L
$X_e$	Chemical contamination in process equipment	g/L
$X_{ic}$	Chemical contamination of the CIP tank inlet flow	g/L
$X_{ie}$	Chemical contamination of the equipment inlet flow	g/L
$X_{oc}$	Chemical contamination of the CIP tank outlet flow	g/L
$X_{oe}$	Chemical contamination of the equipment outlet flow	g/L
$j$	Cleaning cycle of chemical	time

$k$	Number of doubling times that have passed	
$n$	Number of cleaning cycle in a week	time
$\beta$	Ratio of the bypass steam affected from the size of flowrate	
$\mu$	Ratio of the bypass steam affected from imperfect dissolution of contamination	

#### Optimization

$A$	Acid consumption	L
$B$	Base consumption	L
$C_{min}$	Minimum tolerance concentration	%[mass/volume]
$D$	Draining ratio	%
$W$	Water consumption	L
$X_{max}$	Maximum tolerance concentration	g/L
$m$	Number of cleaning cycle in a month	time

# CHAPTER I

## INTRODUCTION

### 1.1 Motivation

Nowadays, food and beverage productions for distributions have been seriously controlled in many issues from consumer and purchaser-protecting agencies. One of the most important issues which affects product image, concerns about trading contacts and relates to a legal obligation is the cleanliness of products.

To achieve the controls of cleanliness, the key step is not only measurements and separations of the unwanted contaminants in input raw materials, but also cleans up of the residual raw materials which should be properly considered.

The hardness of the residual clean up is respect to many factors. The factor which is the most effect is raw material property. In this research, we have studied about a cleaning process of a dairy plant.

Milk, whitish liquid containing proteins, fats, lactose, vitamins and minerals, is one of the hard-cleaning raw materials. Owing to this liquid property, milk has higher ability to contact with operating surfaces than any solid foods, coat, as thin films, on cold surfaces and arrest, as burnt cruds, on hot surfaces. And, since it is more fertilized with many nutrients than other liquid raw material, microorganisms can increase more rapidly in the residuals. Thus, the cleaning systems in a dairy process have high performance in elimination of all residual contaminations.

In the present, Cleaning In Place (CIP), one of cleaning processes in almost dairy plants, has been applied to clean raw materials and products remained in storage tanks, pipe lines and equipment. The CIP provides reliable, fast, economic and efficient cleaning without dismantling equipment. Moreover, The CIP process has

been continuously developed for more saving chemicals and water, more comfort in operating and more efficiency in cleaning.

However, from the investigation in twenty sampling Thai dairy plants, the average chemical and water consumptions which used in the CIP process have been evaluated as 10-15% and 50-60% of the total chemical and water consumptions respectively. From the data collection in real operations, qualities of waste solutions from CIP processes in each time are varied. In addition, the optimization in cleaning operations still has been deficient. From these reasons, cleaning standard does not exist and the chemical and water consumptions in all rinsing steps are extravagant.

Therefore, we have seen the opportunity to develop a new recirculation in CIP process to save more chemical and water and to achieve more efficient in cleaning. This work studies the process behaviors, designs a recirculation system and optimizes to determine optimal draining ratio of the CIP cleaning chemicals in a dairy plant.

## **1.2 Objective of Research**

The objective of the present work is to study the process behaviors, design a recirculation system and optimize to determine optimal draining ratio of the CIP cleaning chemicals in a dairy plant for decreasing water and chemical consumptions.

## **1.3 Scope of Research**

1. Data is gathered from dairy plants and a pilot plant to develop a mathematical model.
2. Matlab application software is used for simulation and optimization.

## 1.4 Procedure Plan

1. Review a basic of optimization and CIP cleaning process.
2. Study CIP process in dairy plants.
3. Collect data from real cleaning operations.
4. Do an experiment in a pilot plant to collect data.
5. Formulate mathematical models of a CIP process.
6. Optimize the problems to determine the optimal draining ratios of CIP chemical solutions.
7. Discuss the simulation results and make a conclusion.

This thesis is divided into six chapters:

**Chapter I** introduces this research. This chapter consists of motivation, research objective and scope of research and procedure plan.

**Chapter II** presents the literature reviews with a development of technology involving with Cleaning In Place (CIP) process and application of optimization in a chemical engineering filed.

**Chapter III** describes the theoretical background of the cleaning process called “CIP” and several theories involving with this research.

**Chapter IV** explains a research methodology in details

**Chapter V** presents collected data, results of modeling and optimization of chemical cleaning steps in the CIP process.

**Chapter VI** presents the conclusions of this research and makes the recommendations for future work.

## CHAPTER II

### LITERATURE REVIEW

This chapter is divided into two parts. The first part reviews a development of technology involving with Cleaning In Place (CIP) process. And, the Second part describes an application of optimization in a chemical engineering filed.

#### **2.1 Development of Technology involving with CIP Process**

Van der Bruggen and Braeken (2006) explored the possibility of using a process cycle where wastewater treatment is intended for water recycling, taking into account the mass balance of materials other than water and the energy balance as well. Three steps in their approach have been discussed consecutively: (1) investigation of the current water balance; (2) optimization of the water consuming processes; and (3) development of an overall concept for the optimized processes, with a zero discharge or virtual zero discharge of water (and other materials), and a minimal consumption of energy. The first step requires full knowledge and control of all water consuming processes, including e.g., cleaning-in-place (CIP) operations, rinsing etc. In the second step, processes are combined by reusing waste water of a process as incoming water for another process. Examples are cooling processes, tank cleaning and truck cleaning. The final step is the regeneration of wastewater so that it can be recycled to (one of) the processes. Membrane technology plays a key role in this step. This scheme includes ultrafiltration (UF) for removal of particles, fibres and suspended solids, and nanofiltration (NF) for the removal of salts and organic matter. The NF concentrate is to be treated separately in a dewatering step.

Bremer et al. (2006) investigated the effectiveness of caustic and acid wash steps in reducing the number of viable bacteria attached to stainless steel (SS) surfaces under dairy plant conditions by a laboratory scale. In their work, standard CIP effectiveness was compared to alternative cleaning chemicals. Then, the addition

of a caustic additive, Eliminator, enhanced biofilm removal compared to the standard CIP regime and further increases in cleaning efficiency occurred when nitric acid was substituted with Nitroplus. The combination of NaOH plus Eliminator and Nitroplus achieved a 3.8 log reduction in the number of cells recovered from the stainless steel surface. The incorporation of a sanitizer step into the CIP did not appear to enhance biofilm removal. This study has shown that the effectiveness of a “standard” CIP can possibly be enhanced through the testing and use of caustic and acid blends. There are many implications of these findings, including: the development of improved cleaning regimes and improved product quality, plant performance, and economic returns.

Forstmeier et al. (2003) investigated the applicability of ultrafiltration and nanofiltration for the treatment of rinsing water in a liquid detergent. Suitable membrane was found and tested in pilot plant. Under realistic conditions, the membranes potential for reducing the COD load in the wastewater by up to 96%.

Graßhoff (2002) studied the use of cleaning agent containing enzymes to reduce the chemical loading of cleaning effluents from milk pasteurizer heat exchangers was investigated on the laboratory and plant scale. These studies indicated that enzyme-based cleaning of milk heaters can be effective.

Van Asselt (2002) developed monitoring systems in CIP process. In this study the monitoring of fouling removal was compared with conductivity measurements. Furthermore, the turbidity and calcium sensor were studied for decreasing cleaning time and an operating cost in CIP process.

Ge'san-Guiziu et al. (2002) presented the recovery of caustic CIP detergent solution under the large variations in composition (pollution, surface tension, etc) of the industrial caustic solutions coming from milk standardization and pasteurization plant CIP throughout their life time (7 days) and from 1 week to another. Their work is also intended to show how nanofiltration was robust and performed well, with good recovery of caustic solutions, even when faced with large variations of solutions composition. Equations have been established for the prediction of permeation flux ( $J$ ) as a function of initial membrane hydraulic resistance ( $R_m$ ) caustic concentration,



volume reduction ratio (VRR) and initial soluble COD. When VRR increased, both permeation flux and pollution retention decreased despite the increase in irreversible fouling induced by the increase of soluble pollution concentration in retentate. The higher the initial soluble COD, the sharper the decrease in  $J$  vs. VRR. Since irreversible fouling was usually small, the membrane cleaning could be efficiently performed by using single phase sodium hypochlorite alternately with a more expensive acid–base cleaning sequence. The obtained permeate was a clear regenerated cleaning solution with low soluble COD (0.2–3.5 g/l) and surface tension (56–30 mJ/m<sup>2</sup>) which could be successfully exploited owing to its cleaning potential.

## 2.2 Optimization

Eliceche et al. (2007) used optimization to minimize environmental life cycle impact when a detail process modeling was available. A methodology was presented to calculate the optimum operating conditions of an ethylene process utility plant. The overall environmental impact was calculated as a weighted sum of global warming, acidification, eutrophication, photochemical oxidation, ozone depletion, human toxicity and ecotoxicity. The battery limits of the plant are extended to include the relevant environmental impacts corresponding to the imported electricity generated in thermoelectric, hydroelectric and nuclear plants. A mixed integer non-linear programming problem is formulated and solved in General Algebraic Modeling System (GAMS). Significant reductions in environmental impact particularly in global warming, the most relevant category, are obtained choosing the pressure and temperature of high, medium and low pressure steam headers together with the selection of optional drivers and boilers. Improvements achieved simultaneously in natural gas and electricity consumption and operating cost are also reported.

Carlos et al. (2007) described an optimization approach for water-using systems that considers two criteria: (1) the minimization of freshwater consumption and (2) the minimization of the infrastructure cost required to build the network. The optimization model considers water reuse between operations and wastewater treatment as the main mechanisms to reduce freshwater consumption. The model is solved using multi-objective distributed Q-learning (MDQL), a heuristic approach based on the exploitation of knowledge acquired during the search process. In order

to compare the quality of the results obtained with MDQL, the reduced gradient method was applied to solve a weighted combination of the two objective functions used in the model. The proposed approach was tested on three cases: (1) a single contaminant four unitary operations problem where freshwater consumption is reduced via water reuse, (2) a four contaminants real-world case with ten unitary operations, also with water reuse, and (3) the water distribution network operation of Cuernavaca, Mexico, considering reduction of water leaks, operation of existing treatment plants at their design capacity, and design and construction of new treatment infrastructure to treat 100% of the wastewater produced. It is shown that the proposed approach can solve highly constrained real-world multi-objective optimization problems.

Forstmeier et al. (2005) applied the optimization approach to manage the water using in a liquid detergent production plant according to the concept for retrofit optimization of water networks (CROWN) strategy in order to reduce freshwater consumption and the costs for wastewater disposal. In this work, a membrane process and a disinfection step are integrated into the water network in order to recycle process water and to recover concentrated product solutions.

Jödicke et al. (2001) presented a mixed integer linear programming (MILP) model optimization to obtain the optimal wastewater reuse design. In this paper easily accessible data such as process location, current water demand, and binary information on the reuse possibilities of wastewater streams are required. The total costs are minimized for a given time horizon. One characteristic of calculating the piping cost is that splitting and merging of pipes are taken into account. The model was applied to an industrial case study for which several reuse designs were generated and discussed with regard to economical (payback time, investment costs), ecological (total flowrate), and technical aspects.

Bird and Espig (1994) optimized the cost of dairy CIP cycles. They analyze a typical multistage acid/alkali dairy CIP cycle to examine the effect of detergent temperature, flow rate and concentration. Results show that the selection of cleaning agent concentration and temperature influence costs most, while flow rate selection requires process specific down time cost knowledge prior to optimization.

From stated above, we have found that there are many researches involving with the development of the CIP process such as the development of the monitoring system, the chemical and water saving by recycling and treatment, the optimization for decreasing the consumptions and the expense, the design of the water treatment system and so on. However, in the real operation system it is necessary to have an analysis of the chemical and water quality before recycling or treating for decreasing wastes and treating payment. Since, this work have studied the possibility of reuse of some part of chemicals which are used the CIP process without treatment and have determined the draining ratios, It can be applied in the analyzing step before the treatment process to decrease the treating payment.

## CHAPTER III

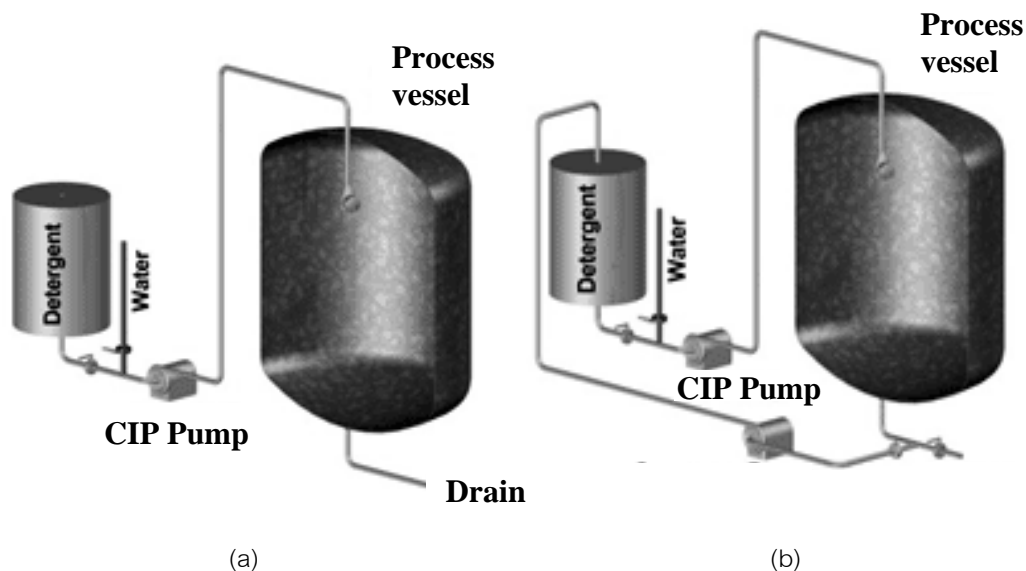
### THEORETICAL BACKGROUND

In this chapter, the theoretical background of the Cleaning In Place (CIP) process, the model of CIP process and the optimization have been described.

#### 3.1 Cleaning In Place (CIP) process.

##### 3.1.1 What is a CIP process?

Cleaning In Place, CIP, is one of the methods for cleaning visible, invisible dirt and microorganisms from the interior surfaces of pipes, vessel, process equipment and associated fittings. By circulations of rinsing water and cleaning chemicals through the inside of cleaning targets, the process equipments can be cleaned and sanitized without dismantling.



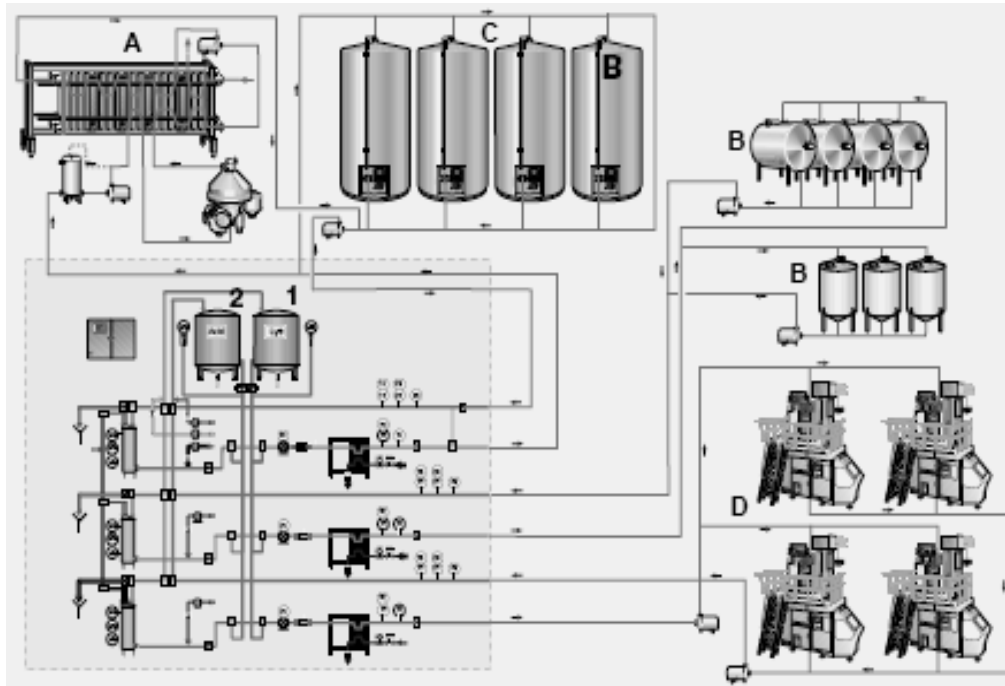
**Figure 3.1** Cleaning passages of CIP process in non-circulative (a) and circulative (b) cleaning (reference: <http://www.lenntech.com/cleaning-CIP.htm>)

Up to the 1950s, closed systems were disassembled and cleaned manually. The advent of CIP was a boon to industries that needed frequent internal cleaning of their processes. Industries that rely heavily on CIP are those requiring high levels of hygiene, including processed foods, beverage, cosmetics and pharmaceutical processes. The benefit to industries that use CIP is that the cleaning is faster, less labor intensive, repeatable, and pose less of a chemical exposure risk to people. CIP started as a manual practice involving a balance tank, centrifugal pump, and connection to the system being cleaned. Since the 1950s, CIP has evolved to include fully automated systems with a programmable logic controller, multiple balance tanks, sensors, valves, heat exchangers, data acquisition, etc. However, manually operated CIP systems can still be found in use today, especially in Thailand.

### **3.1.2 Types of CIP system.**

The CIP system can be divided from distribution configuration of the chemical and water to process equipments into two types as the centralized and decentralized CIP systems.

1. *Centralized CIP system* is the system distributing water and detergent solutions from the CIP storage tanks in the central station to the various CIP circuits. Therefore, this system used mainly in small plants which have relatively short communication lines.



**Cleaning unit (within the broken line)**

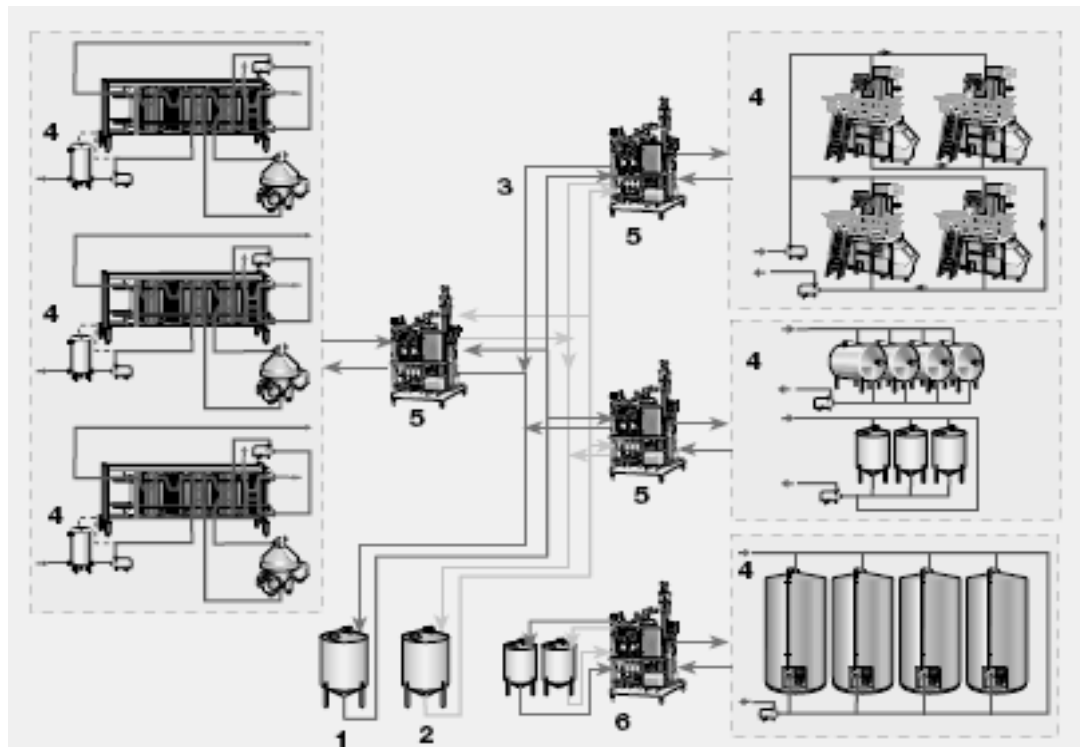
1. Tank for alkaline detergent
2. Tank for acid detergent

**Object to be cleaned**

- A Milk treatment
- B Raw milk tank
- C Product tanks
- D Filling machines

**Figure 3.2** Centralized CIP system (reference: dairy processing handbook)

2. *Decentralized CIP system* is the CIP system composed by a number of smaller CIP stations located close to the various groups of process equipment. Because of the shorter distance, this type of CIP is an attractive alternative for large plants.

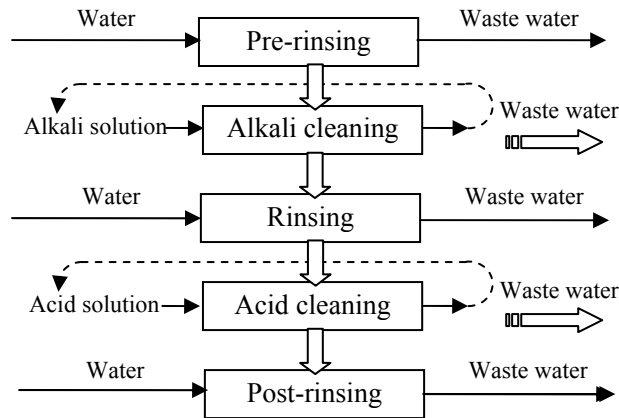


1. Storage tank for alkaline detergent
2. Storage tank for acid detergent
3. Ring lines for detergents
4. Objects to be cleaned
5. Satellite CIP unit
6. Decentralized CIP system with its own detergent tanks

**Figure 3.3** Decentralized CIP system (reference: dairy processing handbook)

### 3.1.3 Cleaning steps of CIP process.

To ensure the cleanliness of the production systems properly, a set of cleaning steps as shown in figure 3.4 is performed in a CIP process. Although, some details in cleaning steps may be differed in each plant, main steps are quite similar. Five steps of CIP process can be explained consequently.



**Figure 3.4** Cleaning steps of general CIP process

1. *Pre-rinsing step* Soiled equipment surfaces are primarily rinsed with water to remove the gross amounts of loose food soils.

2. *Alkali cleaning step* A hot alkali solution, generally sodium hydroxide 0.5-1.5% (mass/volume) 80-90°C, is used as a detergent solution in a circulative, or non-circulative, cleaning. Thus, in this step almost of the residual food soils remaining from the first step are eliminated.

3. *Rinsing step* In this step water is used to remove all remaining chemical solution and food soil residues of the alkaline cleaning.

4. *Acid cleaning step* Hot mild acid solution, 0.5-1.5% 80-90°C, is used as a cleaning medium in this step. In general, phosphoric or nitric acid is used for neutralizing any alkaline residues left and removing any mineral soil present in acid cycle, or non-cycle, cleaning step.

5. *Post-rinsing step* This step removes the still soils and residue chemicals.



### 3.1.4 Cleaning principle and variables affecting to cleaning abilities

The cleaning steps are classified into chemical, alkali and acid cleaning steps, and water rinsing steps, pre-rinsing, rinsing and post-rinsing steps. Some principles of cleaning involving the CIP process have been stated nextly.

#### *Rinsing principle*

The principle of water rinsing was explained by B. Kuser and S. Kuser (1994). The matter is about water rinsing which is a dilution process involved mass transfer principle. Mass which traps on any surfaces is transferred to water in rinsing tank. A mechanism of mass transfer is consisted of diffusion and convection.

Diffusion is about an atomic process. Atom or molecule of the matter that dissolves in water moves to other atoms such as water. Mass transfer of this mechanism occurs from a difference between concentration of the solution at surfaces of cleaning targets with high value and concentration of the solution in rinsing tanks with small value. Diffusion depends on each characteristic of molecular movement and slowly occurs. The velocity of diffusion depends on the temperature and size of diffusion molecule comparison size of molecule.

Convection is a movement of matter in liquid layer. Matter that dissolves in water moves to liquid layer such as water. This mechanism can put the external power such as mixing, pumping and vibrating to accurate fast mass transfer.

#### *Cleaning principle in chemical cleaning step.*

In the CIP process, alkaline and acid cleaning steps are added to raise the cleaning efficiency. Important details in these steps have been explained.

In the alkali cleaning step of the CIP process, the added sodium hydroxide, almost all used alkaline, splits to sodium ion ( $\text{Na}^+$ ) and Hydroxide ion ( $\text{OH}^-$ ). Hydroxides provide the largest portion of alkalinity and effectively saponify fats and peptize proteins for removal. Thus, the fasten contamination remaining from the pre-

rinsing step can be eliminated easily. In acid cleaning, Phosphoric or nitric acid are generally and widely used. Phosphoric acid the agent which can dissolve minerals well and is less corrosive to metals than most other acids but nitric acid use has also expanded greatly due mainly to cost, however nitric is still very effective in the removal of tough mineral deposits.

*Variables effecting to cleaning abilities.*

In the chemical cleaning steps, there are a number of variables must be carefully controlled to ensure satisfactory results with a given detergent solution. These are following as

1. *The concentration of the detergent solution.* To keep the quality of cleaning operation, the amount of detergent in the solution must be adjusted to the correct concentration, generally 0.5-1.5 % mass by volume, before cleaning starts. During cleaning, the solution is diluted with rinsing water and residues. Some neutralization also takes place. It is therefore necessary to check the concentration during cleaning. Failure to do this can seriously affect the result. Oppositely, using too much detergent simply makes cleaning needlessly expensive.

2. *The contamination of the detergent solution.* During the cleaning operation, the amounts of the contaminants in alkaline or acid detergents are raised. Increase of the contamination in detergents directly effects to cleaning ability of a detergent solution. To maintain the cleanliness of the process vessels, all or part volume of the cleaning chemicals should be drained when the maximum tolerance contaminations are reached.

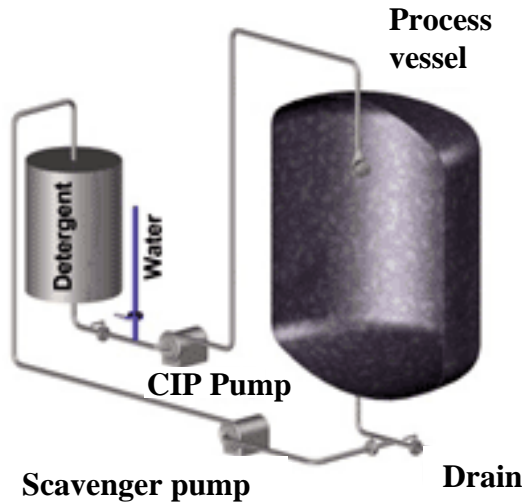
3. *The temperature of the detergent solution.* Generally speaking, the effectiveness of a detergent solution increases with increasing temperature. The cleaning with alkaline detergent should be done at the same temperature as the product has been exposed to, but at least 70°C. Temperatures of 68 – 70°C are recommended for cleaning with acid detergents.

4. *The mechanical effect on the cleaned surfaces.* In mechanized cleaning of pipe systems, tanks and other process equipment, the mechanical effect is supplied by the flow velocity. The detergent feed pumps are dimensioned for higher capacities than the product pumps, with flow velocities of 1.5 – 3.0 m/s in the pipes. At these velocities the liquid flow is very turbulent. This results in a very good scouring effect on the surfaces of the equipment.

5. *The duration of cleaning.* The duration of the detergent cleaning phase must be carefully calculated to obtain the optimum cleaning effect. At the same time the costs of electricity, heating, water and labors must be taken into consideration. It is not sufficient to flush a pipe system with a detergent solution. The detergent must circulate long enough to dissolve the dirt. The time this takes depends on the thickness of the deposits (and the temperature of the detergent solution). Heat exchanger plates encrusted with coagulated protein must be exposed to circulating nitric acid solution for about 20 minutes, whereas 10 minutes' treatment with alkaline solution is enough to dissolve the film on the walls of a milk tank.

### **3.2 Model of CIP process**

The chemical cleaning steps in the CIP process are two-tank circulative continuous process as shown in Figure 3.5. The dynamic behaviors of variables of the CIP process relate with mixing of chemical solution and mixture between water and contaminated in a process vessel which is the cleaning target. Since the process is non-reactive and the chemicals which are generally used are strong base and acid, mixing details in the chemical tanks are quite similar to ideal mixing. However, all flowrates in the systems are quite large when compared with tank volume, the dynamics behaviors of the systems may deviate from the theoretical basis. Therefore, well-mixed tank integrated with bypassing system compartment non-ideal CSTR model for two-tank circulative continuous process is applied to represent the process in this thesis.

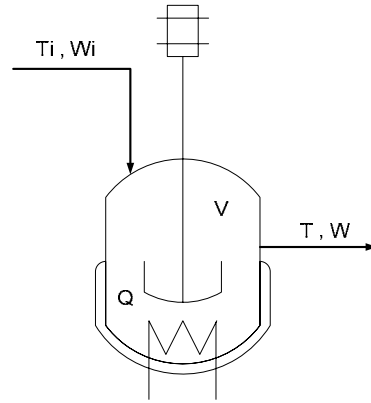


**Figure 3.5** Circulative system of chemical cleaning process  
(reference: <http://www.lenntech.com/cleaning-CIP.htm>)

### 3.2.1 Continuous stirred tank reactor with well-mixed solution system.

*The continuous stirred-tank reactor (CSTR) model* is used to estimate the key unit operation variables when using a continuous agitated-tank reactor to reach a specified output. The mathematical model works for all fluids: liquids, gases, and slurries.

*Perfect mixing or Well-mixed system* is a fair assumption due to the fact that merely requires the region of variable composition at the inlet area is very small when compared to the entire reactor contents and the time required to mix tank contents is very small when compared to the residence time of the reactor. This assumption is required for the model due to the strong dependence of the reaction rate on the concentration of the reagent species.



**Figure 3.6** Well-mixed CSTR model

Integral mass balance on number of moles  $N_i$  of species  $i$  in a reactor of volume  $V$ .

$$[\text{accumulation}] = [\text{in}] - [\text{out}] + [\text{generation}] \quad (3.1)$$

From equation 3.1, we can derive as

$$\frac{dV_i}{dt} = W_{\text{in}} - W_{\text{out}} \quad (3.2)$$

$$V_i \frac{dC_i}{dt} = W_{\text{in}} C_{i,\text{in}} - W_{\text{out}} C_{i,\text{out}} + V_i v_i r_i \quad (3.3)$$

where  $C_i$  is the concentration of species  $i$ ,  $W_{\text{in}}$  and  $W_{\text{out}}$  are the inlet and outlet flowrates of solution,  $C_{i,\text{in}}$  and  $C_{i,\text{out}}$  the concentration of inlet and outlet flow, and  $v_i$  stoichiometric coefficient. The reaction rate,  $r$ , can be figured by using the Arrhenius temperature dependence. Generally, as the temperature increases so does the rate at which the reaction occurs. Residence time,  $\tau$ , is the average amount of time a discrete quantity of reagent spends inside the tank.

In case there is no reaction in the process, Equation 3.2 can be derived as

$$V_i \frac{dC_i}{dt} = W_i C_{i,\text{in}} - W_o C_{i,\text{out}} \quad (3.4)$$

### 3.2.2 Compartment models.

The compartment model is one of the best models for using to represent the systems of the non-ideal reactor. Because of easy understanding sub-procedures and responsibly obtained model, the compartment model has been applied in many works not only to analyze but also to explain how mixing and reacting inside the real reactors are.

In the compartment models, the goal is to model the real reactor with combinations of ideal reactors. The vessel and the flow through the real reactor are considered as follows.

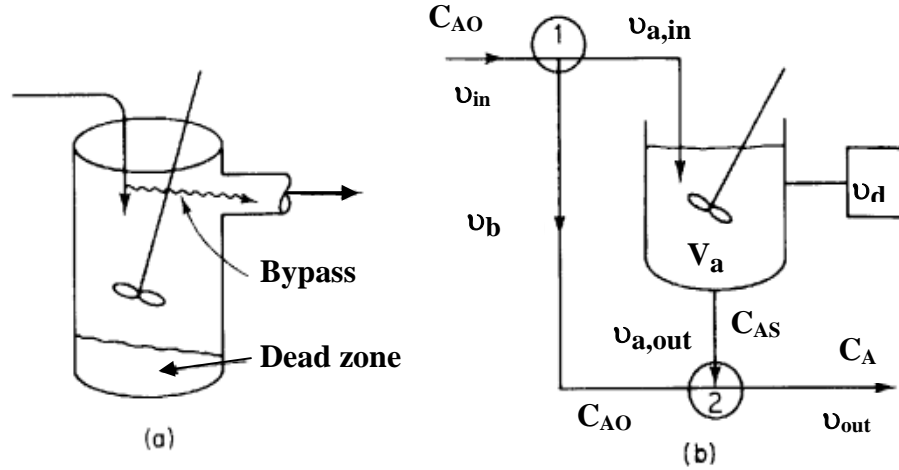
$$\begin{array}{l} \text{Total} \\ \text{volume ...} \\ V \end{array} \left\{ \begin{array}{l} V_p : \text{plug flow region} \\ V_m : \text{mixed flow region} \\ V_d : \text{dead or stagnant region within the vessel} \end{array} \right\} V_a : \text{active region}$$

$$\begin{array}{l} \text{Total} \\ \text{throughflow ...} \\ v \end{array} \left\{ \begin{array}{l} v_a : \text{active flow, that through the active regions} \\ v_b : \text{bypass flow} \\ v_r : \text{recycle flow} \end{array} \right.$$

The compartment model separates the volume of the real reactor to 2 main regions, that is, the active region and the dead or stagnant region. The active region represents the volume of the real reactor which the mixing of the chemical substrates and the reaction occur completely, whereas, the dead region is the region which there is no mixing and reacting. Moreover, the throughflow of the real reactor is also divided into 3 types which are the active flow, bypass flow and the recycle flow.

In general, the compartment model of the real reactors in each case are considered by comparing the E curve (the residence time distribution of fluid) which obtained from using tracer test of the real vessel with the theoretical curves for various combinations of compartments and throughflow, we can find which model best fits the real vessel.

In this thesis, the combination form of compartments and throughflow in the compartment model is considered from the general detail of the process and the dynamics of the chemical concentration and contamination data which have been collected from real systems. Since, the characteristic of the system is continuous cleaning system from the chemical tank to cleaning target, the selected form which is the most suitable combination of the compartment model is considered.



**Figure 3.7** CSTR with bypass and dead region of the real reactor (a) and the compartment model (b)

According to Figure 3.7, the general form of the compartment model for CSTR (CSTR with bypass and dead region of the real reactor) is shown. The tank volume of the model is composed of the active region that have the CSTR characteristic and some volume of tank is the dead region. Moreover, the throughflow of the system is divided into the active and the bypass throughflow. The dynamic behaviors of the system can be described by following equations.

$$\frac{dV_a}{dt} = v_{a,in} - v_{a,out} \quad (3.5)$$

$$V_a \frac{dC_a}{dt} = v_{a,in} C_{AO} - v_{a,out} C_{AS} + V_a v_i r_i \quad (3.6)$$

$$v_{in} = v_{a,in} + v_b \quad (3.7)$$

$$v_{out} = v_{a,out} + v_b \quad (3.8)$$

$$v_b = \beta v \quad (3.9)$$

$$V = V_d + V_a \quad (3.10)$$

$$V_a = \alpha V \quad (3.11)$$

where  $v_{a,in}$  and  $v_{a,out}$  are the inlet and outlet flowrate to the active region of the reactor.  $V$ ,  $V_a$  and  $V_d$  are the total volume, the volume of the active region and dead region consecutively.  $C_a$ ,  $C_{AO}$  and  $C_{AS}$  are the chemical concentration in the reactor, the chemical concentration in inlet and outlet stream respectively.  $v_i$  is stoichiometric coefficient.  $v_b$  is the volume bypassing the reactor and  $\alpha$  and  $\beta$  are the fraction of volume that is well-mixed, and the fraction of the stream that is bypassed.

In case that inlet flowrate = outlet flowrate , the equation 3.6 can be rewritten as

$$V_a \frac{dC_a}{dt} = v(1-\beta)C_{AO} - v(1-\beta)C_{AS} + V_a v_i r_i \quad (3.12)$$

### 3.2.3 Two-tank circulative continuous process.

To simulate the chemical circulative cleaning process, Two-tank circulative continuous process model has been described and derived under the assumption of the compartment model. In this section, the combination of the compartments and flowthrough which is the system of CSTR with bypass and region will be applied to model the process.



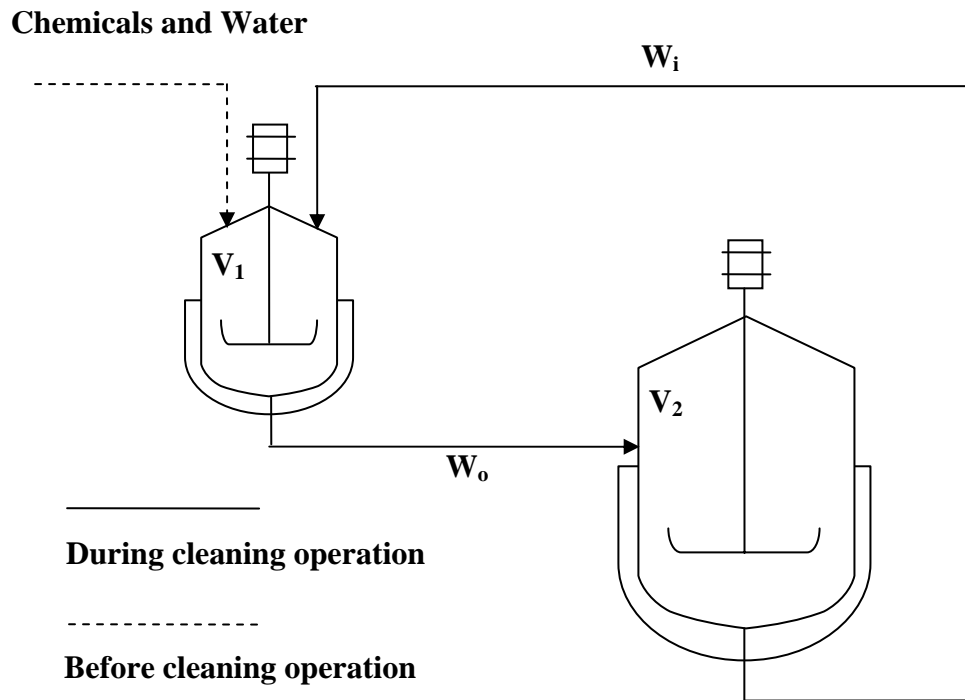


Figure 3.8 Two tanks circulative model

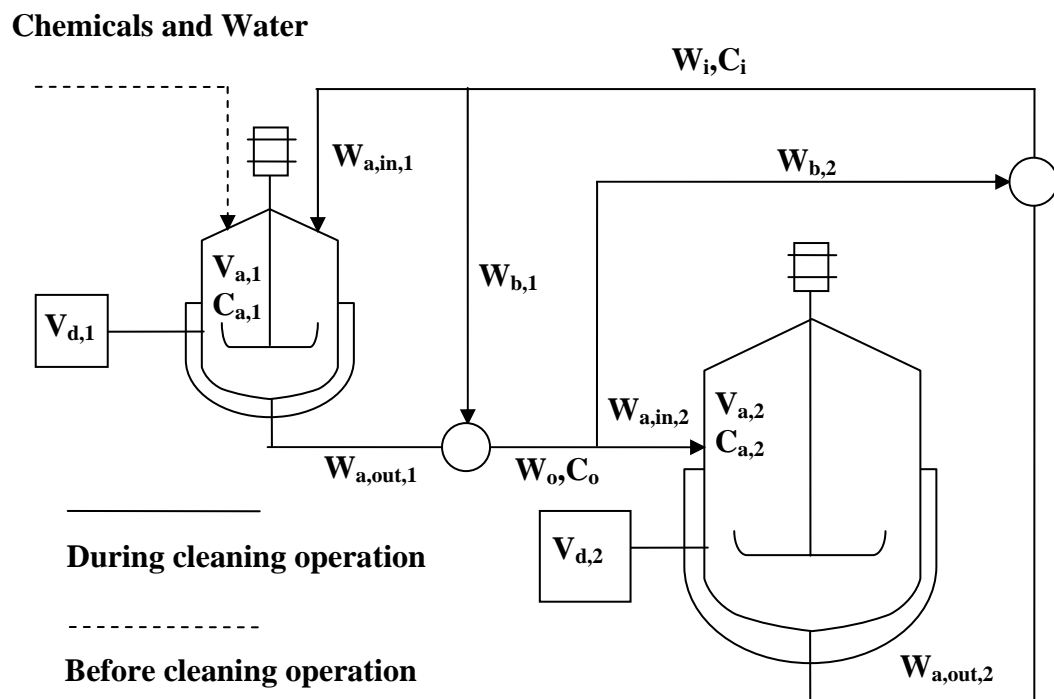


Figure 3.9 Two tanks circulative compartment model

According to Figure 3.9, the material balance in tank 1 and 2 can be described follows equation 3.13 and 3.29 as

$$\frac{dV_1}{dt} = W_i - W_o \quad (3.13)$$

$$\frac{dV_2}{dt} = W_o - W_i \quad (3.14)$$

$$\frac{dV_{a,1}}{dt} = W_{a,in,1} - W_{a,out,1} \quad (3.15)$$

$$\frac{dV_{a,2}}{dt} = W_{a,in,2} - W_{a,out,2} \quad (3.16)$$

$$V_{a,1} \frac{dC_{a,1}}{dt} = W_{a,in,1} C_{a,in,1} - W_{a,out,1} C_{a,out,1} + V_{a,1} v_1 r_1 \quad (3.18)$$

$$V_{a,2} \frac{dC_{a,2}}{dt} = W_{a,in,2} C_{a,in,2} - W_{a,out,2} C_{a,out,2} + V_{a,2} v_2 r_2 \quad (3.19)$$

$$W_i = W_{a,in,1} + W_{b,1} = W_{a,out,2} + W_{b,2} \quad (3.20)$$

$$W_o = W_{a,in,2} + W_{b,2} = W_{a,out,1} + W_{b,1} \quad (3.21)$$

$$W_{b,1} = \beta_1 W_i \quad (3.22)$$

$$W_{b,2} = \beta_2 W_o \quad (3.23)$$

$$V_1 = V_{d,1} + V_{a,1} \quad (3.24)$$

$$V_2 = V_{d,2} + V_{a,2} \quad (3.25)$$

$$V_{a,1} = \alpha_1 V_1 \quad (3.26)$$

$$V_{a,2} = \alpha_2 V_2 \quad (3.27)$$

$$C_o = W_{a,out,1} C_{a,out,1} + \beta_1 W_i C_i \quad (3.28)$$

$$C_i = W_{a,out,2} C_{a,out,2} + \beta_2 W_o C_o \quad (3.29)$$

where  $V_1$  and  $V_2$  is the solution volume in tank 1 and tank 2.  $W_i$  and  $W_o$  are inlet and outlet volumetric flow rate.  $V_{a,1}$  and  $V_{a,2}$  is the solution volume in the active region in tank 1 and tank 2.  $V_{d,1}$  and  $V_{d,2}$  is the solution volume in the dead region in tank 1 and tank 2.  $W_{a,in,1}$   $W_{a,in,2}$   $W_{a,out,1}$  and  $W_{a,out,2}$  are the inlet volumetric flow rate

to the active region in tank 1 and tank 2 and outlet volumetric flow rate from the active region in tank 1 and tank 2 respectively.  $W_{b,1}$  and  $W_{b,2}$  are the bypass volumetric flowrate in tank 1 and tank 2. And, two parameters  $\alpha$  and  $\beta$  are the fraction of volume that is well-mixed, and the fraction of the stream that is bypassed.

Since, the level of chemical in the CIP tank must be balanced during the cleaning process, inlet flowrate and outlet flowrate are set equally. Furthermore, the process is non-reactive. The last term of 3.18 and 3.19 and the dead volume which has very large effect for reactive process are neglected. Therefore, the material balance of process is re-written as

$$\frac{dV_{a,1}}{dt} = W_{a,in,1} - W_{a,out,1} \quad (3.30)$$

$$\frac{dV_{a,2}}{dt} = W_{a,in,2} - W_{a,out,2} \quad (3.31)$$

$$V_1 \frac{dC_{a,1}}{dt} = (1-\beta)W_i (C_{a,in,1} - C_{a,out,1}) \quad (3.32)$$

$$V_2 \frac{dC_{a,2}}{dt} = (1-\beta)W_o (C_{a,in,2} - C_{a,out,2}) \quad (3.33)$$

$$C_o = \beta_1 C_i + (1-\beta_1) C_{a,1} \quad (3.34)$$

$$C_i = \beta_1 C_o + (1-\beta_1) C_{a,2} \quad (3.35)$$

Because the modeling has mainly focused on the dynamic behaviors in tank 1 and the outlet concentration of tank 2 after mixing with bypass flow,  $C_i$ , which generated by the compartment model is the same values as by the well-mixed model, the equations which describes the dynamics for tank 2 have been written under the well-mixed assumption to simplify the model.

### 3.3 Optimization

Optimization is referred to a mathematical procedure to obtain the optimal solution that satisfies limitation of systems or processes. It pervades for solving the complicated problems in many different fields, science, engineering and business. To achieve the goal of each works, problem details are specified by a problem formulation defining the objective function, the equality and inequality constraint, the decision variable and it's bound. Three basic ingredients of the optimization problems are explained as following.

1. *Objective function or cost function.* A function or a group of functions which its input parameters are the decision variables and its output parameter is the objective value. The objective function is minimized or maximized for obtaining the best solution while the optimization is processing. For example, operation cost or net profit in production.

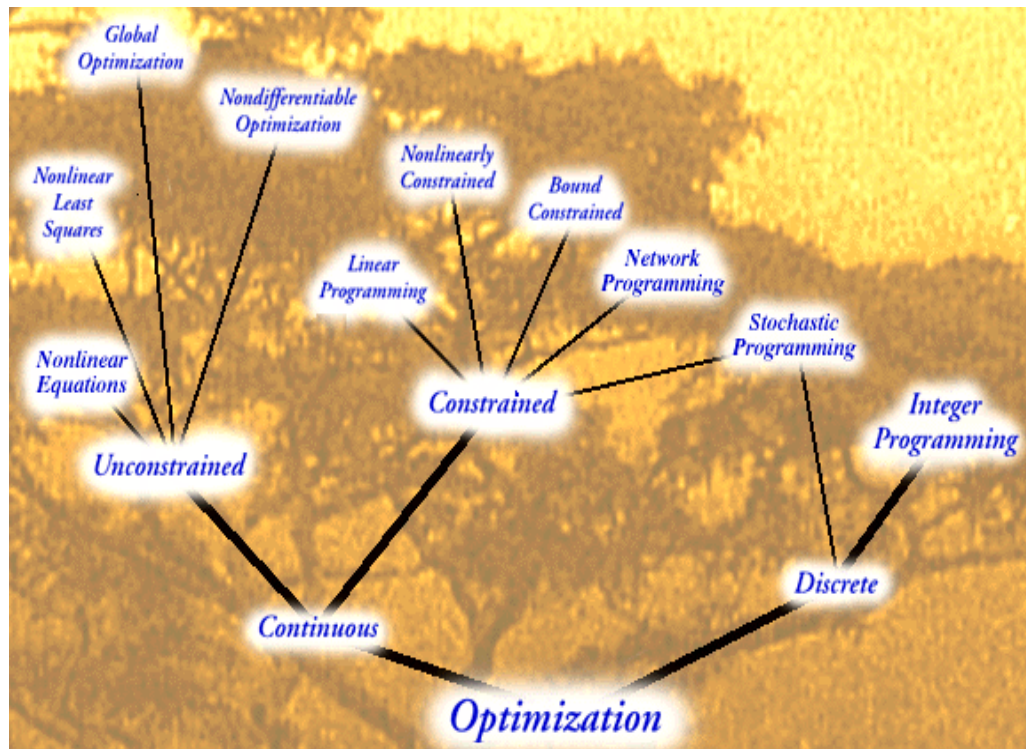
2. *Constraint.* A condition that a solution of the optimization problem must satisfy in order to be acceptable. The set of solutions that satisfy all constraints is called the feasible set. The constraint can be divided into two kinds, equality and inequality constraint. Both kinds can be described as follows.

- *Equality constraint.* is a mathematical equation which has an appearance of an equality sign ( $=$ ). The general form of an equality constraint is  $Ax = b$ , where A and b are constant and x is a decision variable. For example, mass and energy balances.

- *Inequality constraint.* is a mathematical equation which has an appearance of an inequality sign ( $<$ ), ( $>$ ), ( $\leq$ ), ( $\geq$ ), and ( $\neq$ ). The general form of an equality constraint is  $Ax \geq b$ , where A and b are constant and x is a decision variable, for example, maximum capacity or minimum solution concentration.

3. *Decision variable and its bound* In general, the decision variable is an unknown quantity needed to be found for achieving the goal of the problem. For instance, a size of equipment, an operating condition, flowrates and reactor

temperature. In almost optimization problem, especially in engineering problems, the decision variables are limited in its boundary which defined from data and details of the problem. For examples, maximum size of equipment, minimum and maximum flowrates, maximum tolerance temperature.



**Figure 3.10** Classification of optimization

(reference: [www.wu.ece.ufl.edu/optimization/optimization.html](http://www.wu.ece.ufl.edu/optimization/optimization.html))

The optimization can be classified into two main categories which are continuous and discrete problems. Furthermore, Continuous optimization is divided into two main groups which is unconstrained and constrained problem and both categories can be next divided into many types of problem following as shown in figure 3.10.

### 3.4 Sequential Quadratic Programming (Reference: Optimization of chemical processes)

Successive quadratic programming (SQP) method solved a sequence of quadratic programming approximation to nonlinear programming problem. Quadratic programs (QPs) have a quadratic objective function and linear constraints, and there exist efficient procedures for solving them

#### Problem formulation with equality constraints

To derive SQP, we again consider a general NLP

$$\left. \begin{array}{l} \text{Minimize } f(x) \\ \text{Subject to } g(x)=b \end{array} \right\} \quad (3.36)$$

The Lagrangian function for this problem is

$$L(x,\lambda)=f(x)+\lambda^T(g(x)-b) \quad (3.37)$$

and the Kuhn-Tucker conditions (KTC) are

$$\nabla_x L = \nabla f(x) + \sum_{i=1}^m \lambda_i \nabla g_i(x) = 0 \quad (3.38)$$

and

$$g(x) = b \quad (3.39)$$

The equation (3.36)-(3.37) are a set of (n+m) nonlinear equation in the n unknowns x and m unknown multipliers  $\lambda$ . Linearization of (3.37) and (3.38) with respect to x and  $\lambda$

$$\nabla_x L + \nabla_x^2 L \Delta x + \nabla g^T \Delta \lambda = 0 \quad (3.40)$$

$$g + \nabla g \Delta x = 0 \quad (3.41)$$

For problem with only equality constraints, we could simply solve the linear equations (3.37)-(3.38). To accommodate both equality and inequality, an alternative viewpoint is useful. Consider the quadratic programming problem

$$\text{Minimize } \nabla_x L^T \Delta x + \frac{1}{2} \Delta x^T \nabla_x^2 L \Delta x \quad (3.42)$$

$$\text{Subject to } g + \nabla g \Delta x = 0 \quad (3.43)$$

If we call the Lagrange multipliers for (3.43)  $\Delta \lambda$ , the Lagrangian for the QP is

$$L_1(\Delta x, \Delta \lambda) = \nabla_x L^T \Delta x + \frac{1}{2} \Delta x^T \nabla_x^2 L \Delta x + \Delta \lambda^T (g + \nabla g \Delta x) \quad (3.44)$$

### **Inclusion of the both equality and inequality constraints**

When the original problem has a mixture of equalities and inequalities, it can be transformed into a problem with equalities and simple bounds by adding slacks, so the problem has an objective function  $f$ , equalities (3.36), and bounds

$$l \leq x \leq u \quad (3.45)$$

This system is the KTC for the QP in (3.43) with the additional bound constraints

$$l \leq \bar{x} + \Delta x \leq u \quad (3.46)$$

Here the QP sub-problem now has both equality constraints and must be solved by some iterative QP algorithm.

### The approximate Hessian

Solving a QP with a positive-definite Hessian is fairly easy. Several good algorithms all converge in finite number of iterations. However, the Hessian of the QP presented in (3.43) and (3.46) is  $\nabla_x^2 L(\bar{x}, \bar{\lambda})$ , and this matrix need not be positive-definite, even if  $(\bar{x}, \bar{\lambda})$  is an optimal point. In addition, to compute  $\nabla_x^2 L$ , one must compute second derivative of all problem functions. Both difficulties are eliminate by replacing  $\nabla_x^2 L$  by positive-definite quasi-Newton approximate B, which is updated using only values of L and  $\nabla_x L$ . Most SQP algorithms use Powell's modification of the Broyden-Fletcher-Goldfarb-Shanno (BFGS) update. Hence the QP sub-problem becomes

QP( $\bar{x}, B$ )

$$\text{Minimize } \nabla_x L^T \Delta x + \frac{1}{2} \Delta x^T B \Delta x \quad (3.47)$$

$$\text{Subject to } \nabla g \Delta x = -g, \quad l \leq \bar{x} + \Delta x \leq u \quad (3.48)$$

### The SQP line search

To arrive at a reliable algorithm, one more difficulty must be over come. Newton and quasi-Newton method may not converge if a step of 1.0 is used at each step. Both trust region and time search versions of SQP have been developed that converge reliability. A widely used line search strategy is to use the  $L_1$  exact penalty function  $P(x, w)$ . In a line search SQP algorithm,  $P(x, w)$  is used only to determine the step size along the direction determined by the QP sub-problem  $QP(\bar{x}, B)$ . The  $L_1$  exact penalty function for the NLP problem is

$$P(x, w) = f(x) + \sum_{i=1}^m w_i |g_i(x) - b_i| \quad (3.49)$$

where a separate penalty weight  $w_i$  is used for each constraint. The SQP line search chooses a positive step size  $\alpha$  to find an approximate minimum of



$$r(\alpha) = P(\bar{x} + \alpha \Delta x, w) \quad (3.50)$$

A typical line search algorithm, which uses the derivative of  $r(\alpha)$  evaluated at  $\alpha = 0$  denote by  $r'(0)$ , is

1.  $\alpha \leftarrow 1$
2. if  $r(\alpha) < r(0) - 0.1\alpha r'(0)$  (3.51)  
stop and return the current  $\alpha$  value

3. Let  $\alpha_1$  be the unique minimum of the convex quadratic function that passes through  $r(0)$ ,  $r'(0)$  and  $r(\alpha)$ . Take the new estimate of  $\alpha$  as

$$r(\alpha) \leftarrow \max(0.1\alpha, \alpha_1) \quad (3.52)$$

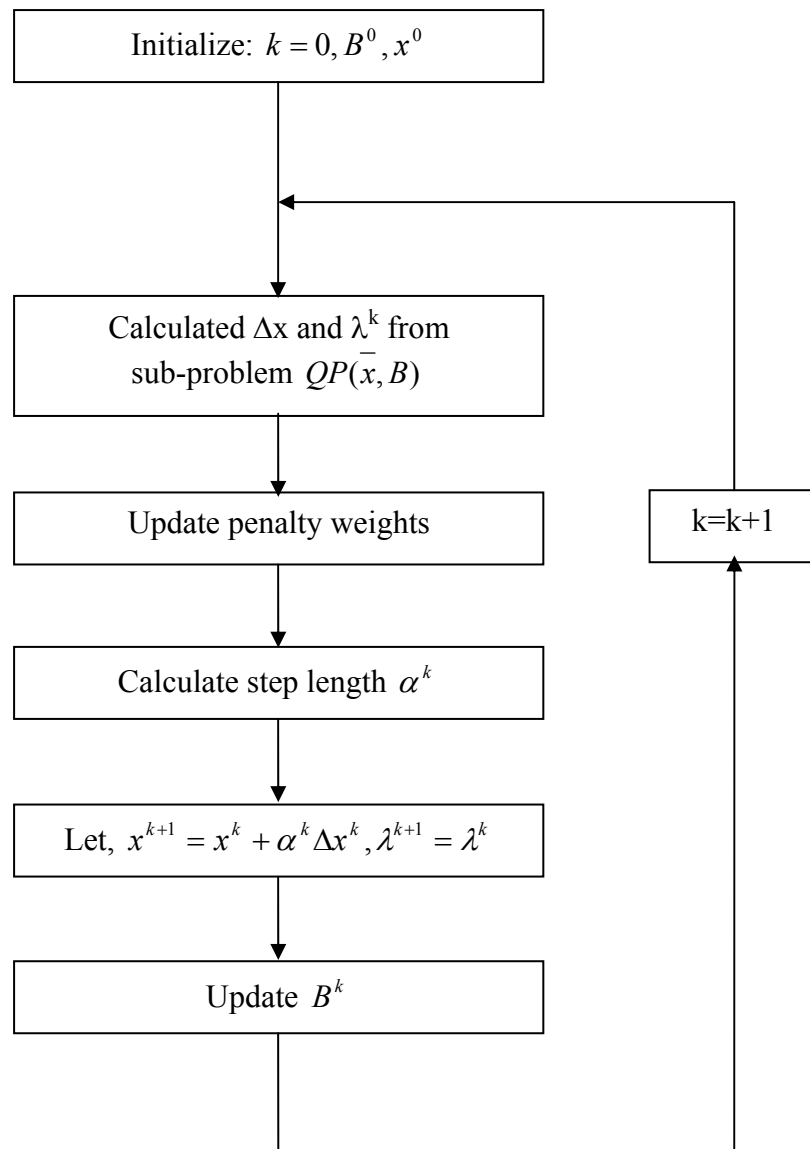
4. Go to step 2.

### SQP algorithm

Base on this line search and the QP sub-problem  $QP(\bar{x}, B)$

1. Initialize:  $B^0 \leftarrow I$ ,  $x^0 \leftarrow x$ ,  $k \leftarrow 0$
2. Solved the QP sub-problem  $QP(\bar{x}, B)$ , yielding a solution  $\Delta x^k$  and Lagrange multiplier estimates  $\lambda^k$
3. Update the penalty weights in penalty function
4. Apply the line search algorithm, yielding a positive step size  $\alpha^k$

5.  $\mathbf{x}^{k+1} = \mathbf{x}^k + \alpha^k \Delta \mathbf{x}^k, \lambda^{k+1} = \lambda^k$
6. Evaluated all problem function and their gradients at new point. Update matrix  $B^k$
7. Replace  $k$  by  $k+1$ , and go to step 2



**Figure 3.11** Flowchart of SQP algorithm

## CHAPTER IV

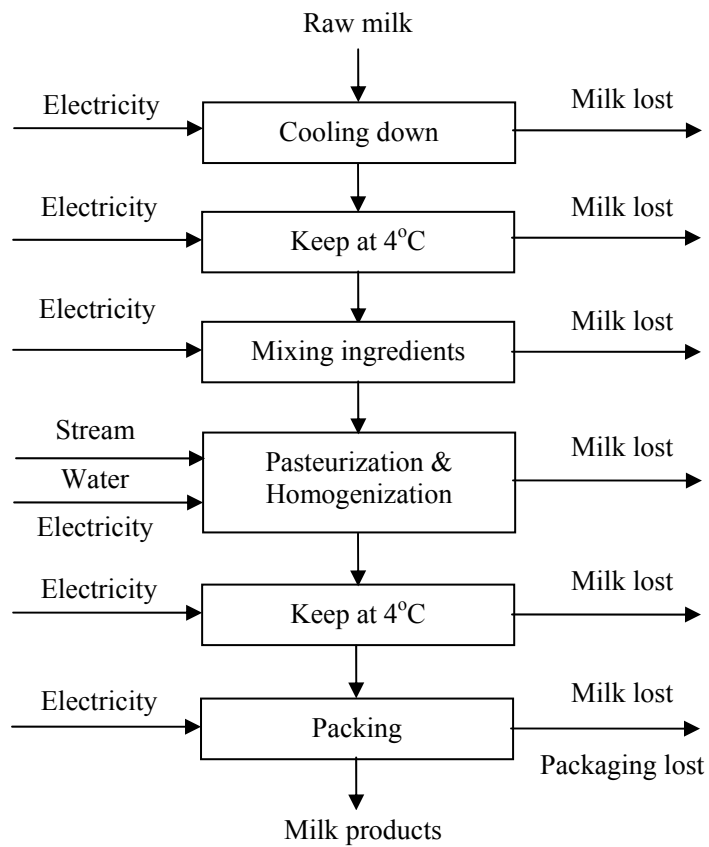
### RESEARCH METHODOLOGY

In this chapter, four steps to obtain an optimal draining ratio of chemicals in the CIP process have been presented sequentially. Firstly, the CIP process in dairy plant has been studied. Secondly, the mathematical model of the CIP process in dairy plant has been developed. Then, the experiment has been performed in the plant to collect data for validating the mathematical model. Lastly, optimization problem has been formulated for determining the optimal values of the draining ratio.

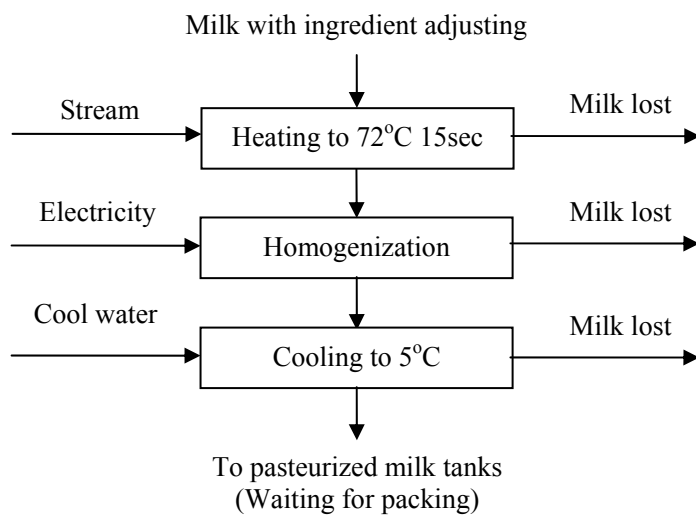
#### 4.1 Cleaning In Place Process in Dairy Plant

##### 4.1.1 Milk production process

Milk production process in dairy plants can be illustrated by Figure 4.1. The process details have been clarified as follows. First step, received raw milk is cooled down and forwarded to raw milk tanks to keep a temperature at 4°C for prohibiting microorganism growths. Then, the raw milk is blended and mixed with ingredients, such as sugar, coco powders and other taste and color adjusting materials. Then, it is passed to disinfect by the pasteurization process, the harmful microorganisms destroying process using heating and keeping in a time period, generally 72°C for 15 sec (HTST pasteurization method), and quickly cooling down to 5°C as shown in a pasteurization sub-procedure diagram on Figure 4.2. Actually, between the heating and cooling in the pasteurization process there is an important step called homogenization, the process aiming to prevent or delay the separation of cream from the rest of the emulsion. The fat in milk normally separates from the water and collected at the top. Homogenization is the process of breaking up that fat into smaller sizes so that it no longer separates from the milk. After these steps, the pasteurized and homogenized milk is maintained temperature at 4°C in the pasteurized milk tanks before starting the packing process.



**Figure 4.1** Pasteurized milk process



**Figure 4.2** Pasteurization and homogenization sub-procedure



**Figure 4.3** Milk receiving step



**Figure 4.4** Heat exchanger used in pasteurization process



**Figure 4.5** Homogenizer



**Figure 4.6** Pasteurized milk tanks



**Figure 4.7** Packing machines



**Figure 4.8** CIP station

#### 4.1.2 Cleaning operation of CIP process in the dairy plant

To study the real cleaning operations, Thai medium dairy plant has been visited. A decentralize CIP process which obligates the cleanliness of three pasteurized milk tanks and seven packing machines, total interior non-heating surfaces of 1200 m<sup>2</sup> estimately, has been investigated.

The CIP operation in the dairy plant has been studied and can be explained nextly. In the regular production capacity, the CIP process is operated two times in a day, the cleaning before the production start and after the production end. To understand the problem, details of the plant cleaning operations are illustrated.

*The cleaning before the production start* is operated for sanitizing the process equipment before the production start. For the visited plant operation, only packing machines are cleaned in this CIP cleaning program.

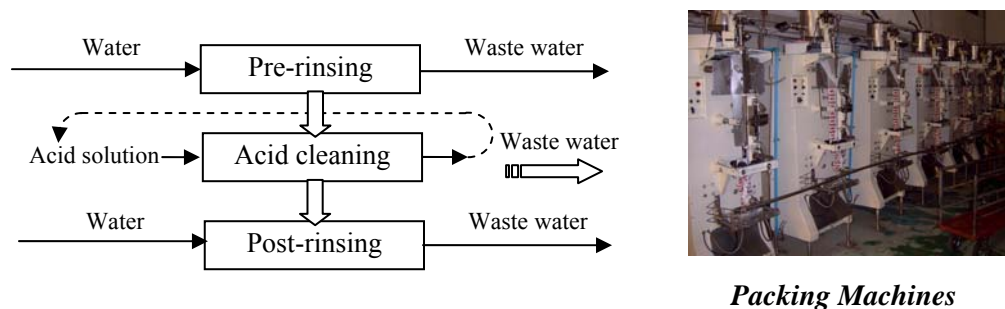


Figure 4.9 Cleaning steps of CIP process before the production start

According to Figure 4.9, the steps of the CIP process before the production start have been shown. Three steps for eliminating the contamination, especially microorganism contaminations, and preparing for the production has been detailed sequently. In the first step, the pre-rinsing step, the packing machines are rinsed by the water. Then, hot dilute nitric acid, 80-90°C 1-2% (mass by volume) HNO<sub>3</sub>, is used to sanitize the cleaning targets for 10 minutes circulation time. The last step is the post rinsing step which cleans and disinfects the packing machines with the hot water, 80-90°C, about 10 minutes.



The cleaning after the production end is performed to ensure the cleanliness of the process vessels, pasteurized milk tanks and packing machines, that no residues which affects product qualities remains in the process equipments.

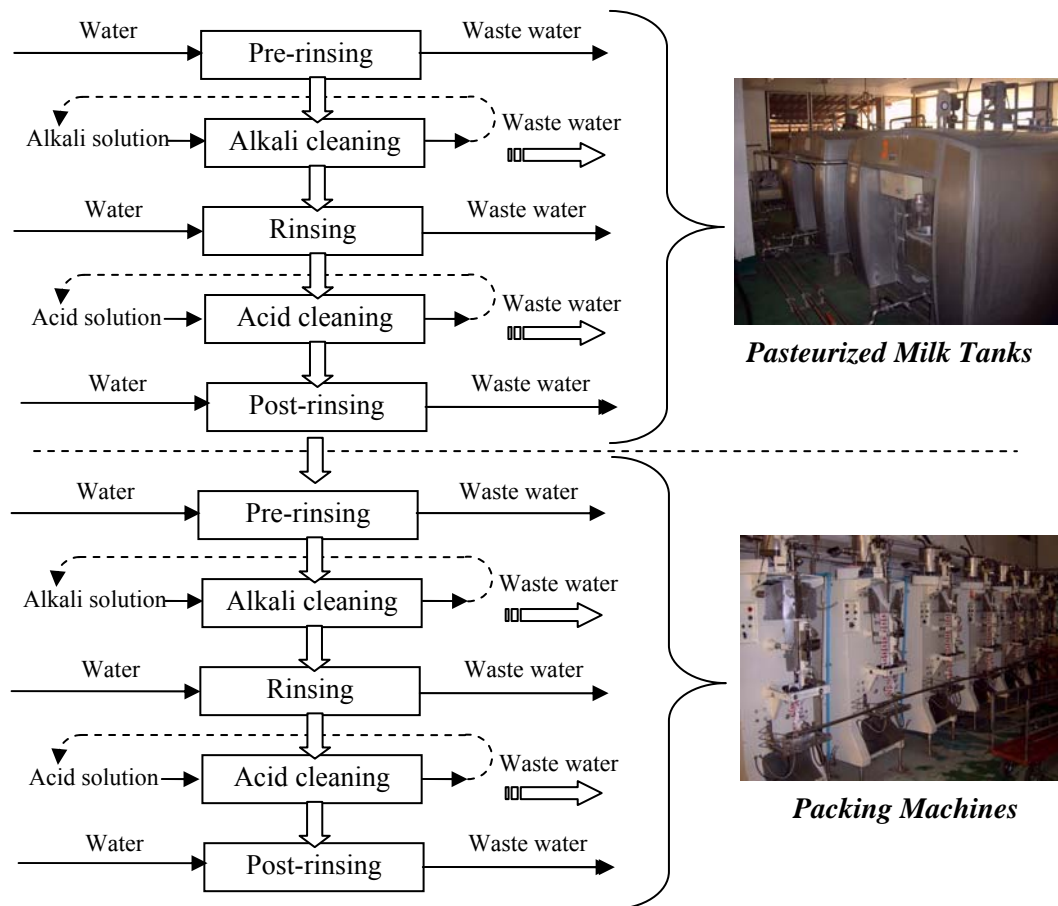


Figure 4.10 Cleaning steps of CIP process after the end of the production

The steps of the CIP process after the end of the production, Figure 4.10, have been illustrated. The several procedures for removing the residual contamination in the pasteurized milk tanks and the packing machines have been described consecutively. At first, the cleaning targets are aimed to the pasteurized milk tanks. Three pasteurized milk tanks are cleaned with a set of cleaning steps as follows, the pre-rinsing step is used for remove the loose soils with water. For the second step, 80-90°C 1-2% sodium hydroxide is used as a cleaning medium for circulating in the pasteurized milk tanks and the packing machines for 10 minutes. Then, the water is used for cleaning the still residual soil and chemicals before the acid cleaning operated. The acid cycle cleaning is performed to clean residual minerals and

chemicals with hot dilute nitric acid at the same temperature and concentration. And the last step, the hot water, 80-90°C, is used to remove all contaminations in the pasteurized milk tanks the post rinsing step.

After finishing the pasteurized milk tanks cleaning, the CIP operation for the packing machines is begun with the same steps as the previous cleaning, pasteurized milk tank cleaning operation. After the all steps are done, The CIP process for the end of the production is completed.

From mentioned above, we have found that two and three times/day cleaning operation for alkali and acid cleaning respectively. The numbers of cycle times effects to dynamic behaviors of CIP cleaning chemicals and have been expressed in the process models in the later topic.

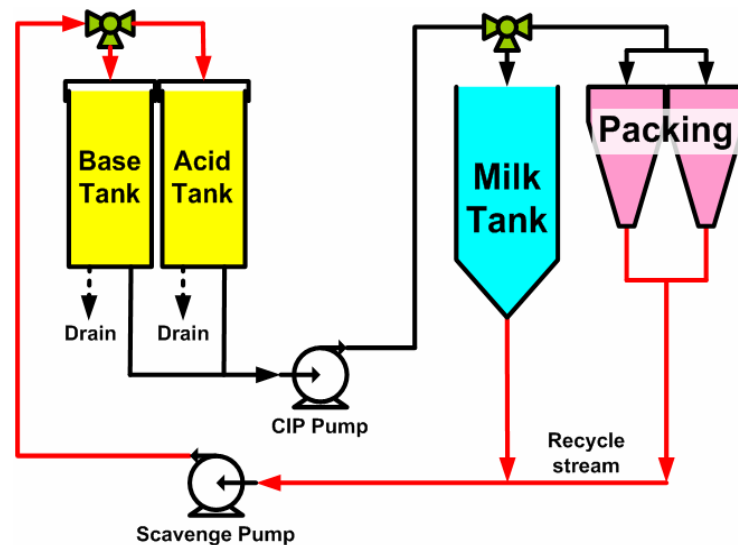
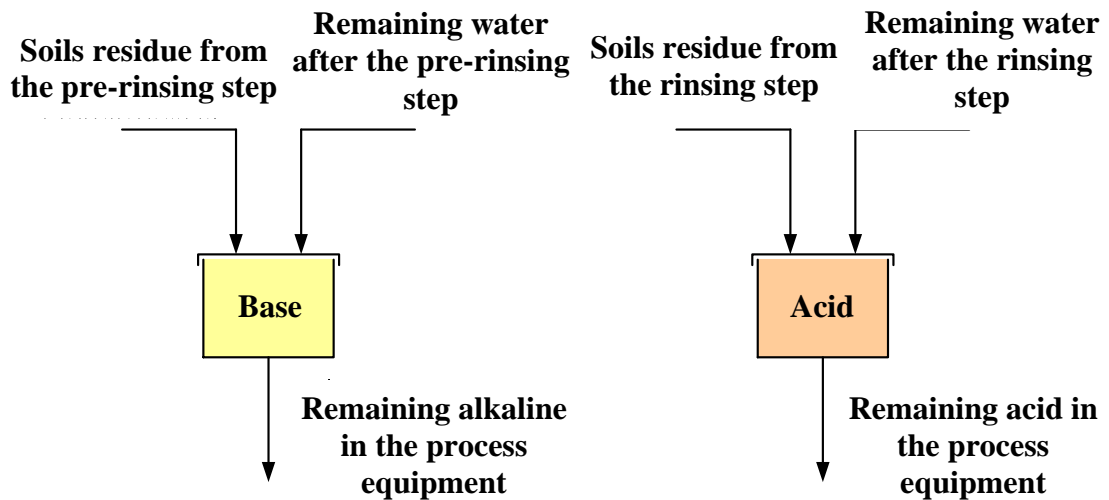


Figure 4.11 Flow diagram of chemicals during CIP cleaning operations

In the previous topic we have explained the cleaning procedures in CIP process before and after the production. In this topic, the flow diagrams of cleaning chemicals during the cleaning operations in the visited plant have been talked about. From figure 4.11, pathways of acid and alkali cleaning solution have been shown. When starting the chemical cleaning steps, Acid or base is sent by CIP pump forwarding to the pasteurized milk tanks or the packing machines. The CIP pump sends the chemicals through ball valves for spraying to clean all inner surfaces of the

process equipments. Then, the used chemicals which remain in the system is returned to CIP chemical tanks by scavenge pump and pumped forward to the system cycle to cycle during ten minutes cleaning.



**Figure 4.12** Material balance of alkaline around alkaline and acid tanks

In the period of chemical cleaning operations, the contaminations and concentrations are varied. This dynamics can be explained with material balance diagram on figure 4.12 for alkali and acid respectively.

During the alkaline cleaning operation, the residual milk from pre-rinsing step and remaining water after the pre-rinsing step are mixed with cleaning chemical and sent to the chemicals tank by scavenge pump and some part of cleaning chemical which has higher concentration and lower contamination than the mixed solution in the cleaning target remained in the process equipments.

In the acid cleaning operation, similar to the alkali cleaning operation, the residual soils and the water remaining from rinsing step are blended with cleaning chemical. The mixed solution is pumped to CIP chemical tank while some part of acid cleaning chemicals stills in the production equipments.

During a cleaning cycle the chemical concentration decrease and the contaminations increase to any constant values. To maintain the cleaning qualities of chemicals, the chemical concentrations are measured by laboratory testing every after the last step of CIP process after the end of the productions completed and manually

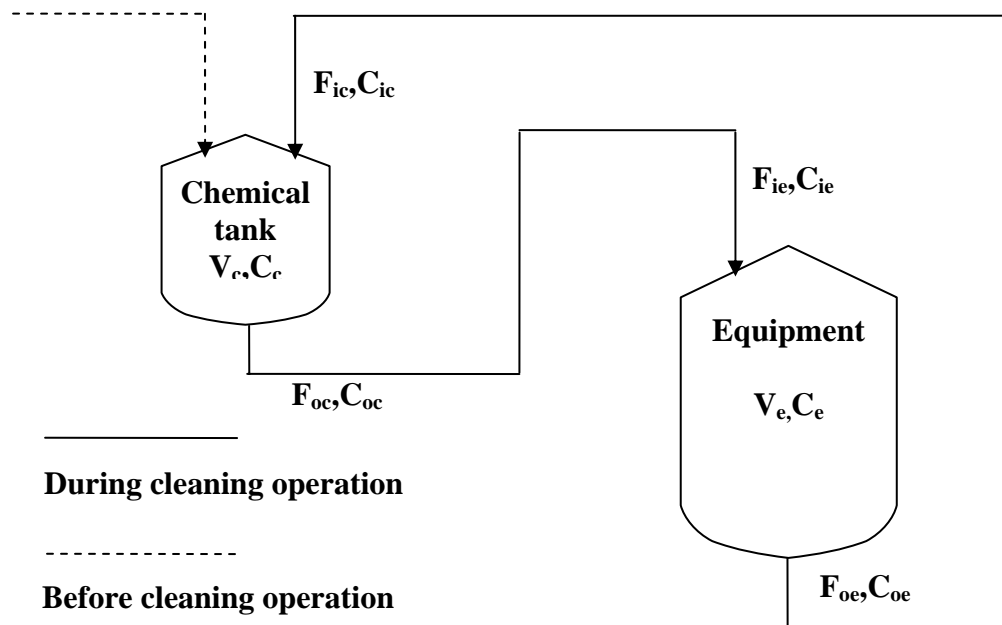
adjusted to 1-2% mass/volume concentration. After the chemical solutions used for a week, 6 days operation, the cleaning chemicals, both alkaline and acid, are drained to keep the contaminations not overabundant.

## 4.2 Model of Cleaning In Place Process in Dairy Plant

### 4.2.1 Mathematical modeling

In this research, we have interested in the chemical cleaning steps which are two-tank continuous circulative process. To understand the process behaviors, two variables of chemical cleaning step effecting to cleaning efficiency, concentration and contamination of detergent have been observed. The process models for the CIP process involve with material balances, microbial data and all parameters and initial conditions have been gathered from real plant cleaning operation data. The mathematical models which represent the cleaning process have been expressed as following.

#### Chemicals and Water



**Figure 4.13** Flow diagram of process

### *Assumptions*

1. All flow rates are quite constant.
2. The densities of solution and chemicals are constant.
3. There is no leakage in the system.
4. There is very little contamination in fresh water.
5. Some volumes of inlet flow bypass to outlet steam

### *Material balance*

$$\frac{dV_c}{dt} = F_{ic} - F_{oc} \quad (4.1)$$

$$\frac{dC_c}{dt} = \frac{F_{ic}(1-\beta)}{V} (C_{ic} - C_{oc}) \quad (4.2)$$

$$\frac{dX_c}{dt} = \frac{F_{ic}(1-(\beta+\mu))}{V} (X_{ic} - X_{oc}) \quad (4.3)$$

$$\frac{dV_e}{dt} = F_{oe} - F_{ie} \quad (4.4)$$

$$\frac{dC_e}{dt} = \frac{F_{ie}}{V_e} (C_{oe} - C_{ie}) \quad (4.5)$$

$$\frac{dX_e}{dt} = \frac{F_{ie}}{V_e} (X_{oe} - X_{ie}) \quad (4.6)$$

$$C_{ie} = C_{oc} = \beta C_{ic} + (1-\beta) C_c \quad (4.7)$$

$$X_{ie} = X_{oc} = (\beta+\mu) X_{ic} + (1-(\beta+\mu)) X_c \quad (4.8)$$

$$F_{ic} = F_{oe} \quad (4.9)$$

$$C_{ic} = C_{oe} \quad (4.10)$$

$$X_{ic} = X_{oe} \quad (4.11)$$

$$N_{cf}(j) = N_{ci}(j) \times R \quad (4.12)$$

Since, the mainly objective of modeling is to explain the dynamics of detergent properties in the chemical tank, The mathematical models of the chemical tanks are derived under the basis of the compartment model whereas the mathematical

models of the equipment which is the cleaning target are formulated by the well-mixed CSTR or the overall balance cover the bypass steam in the compartment model to avoid determining the parameter  $\beta$  and  $\mu$ , the ratio of the bypass steam affected from the size of flowrate and the ratio of the bypass steam affected from imperfect dissolution of contamination.

The concentration, contamination and microbial numbers are defined to new values when the new chemicals are adding to keep the concentrations in usable range, 1-2%, and the operation day reaches to 6 days, new acid and alkaline cleaning chemicals are prepared to use. The new values of concentration, contamination and microbial numbers are defined by

$$C_{ci}(j+1) = \begin{cases} C_{cf}(j) & \text{if } \text{rem}(j,n) \neq 0 \text{ and } C_{cf}(j) > 1 \\ C_{\text{target}} & \text{if } \text{rem}(j,n) \neq 0 \text{ and } C_{cf}(j) < 1 \\ C_{\text{target}} & \text{if } \text{rem}(j,n) = 0 \end{cases} \quad (4.13)$$

$$X_{ci}(j+1) = \begin{cases} X_{cf}(j) & \text{if } \text{rem}(j,n) \neq 0 \\ 0 & \text{if } \text{rem}(j,n) = 0 \end{cases} \quad (4.14)$$

and

$$N_{ci}(j+1) = \begin{cases} 2^k \times N_{cf}(j) & \text{if } \text{rem}(j,n) \neq 0 \\ 0 & \text{if } \text{rem}(j,n) = 0 \end{cases} \quad (4.15)$$

where

$\text{rem}(A,B)$  = function for a value of the remainder after the division of A by B

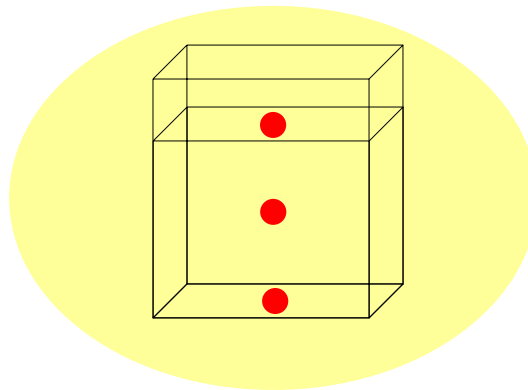
### 4.3 Data Collection

In this thesis, the data collection is consisted of two parts. The first part is the data collection of the concentration and contamination during 10 minutes cleaning duration. The second part involves with the gather of microbial data in invented pilot

plant and real plant data for assuring the cleanliness of chemicals. The methods in each part have been described in the next topics.

#### 4.3.1 Concentration and contamination data

In the first part, we have gathered the concentration and contamination data during 10 min. chemical cleaning for 6 operating days. Samples have been collected from 3 positions of the tank, on the surfaces, at the middle of chemical level and at the bottom of tank, shown as red points in Fig. 5 at every 2 minutes. The 3 position chemical samplings have mixed altogether. Then, this sample has been divided to find concentration in the first part and contamination in second part.



**Figure 4.14** Sampling position in chemical tanks



**Figure 4.15** Sample collections from (a) chemical surface and middle of detergent height and (b) at the tank bottom

In the first part, 10 ml. of the sample has been taken to find the concentration by the titration method. 0.1 mol/dm<sup>3</sup> sodium hydroxide and hydrochloric acid have been used as titants for finding the concentration of acid and alkali cleaning chemicals consecutively.

For another part, 25 ml. of the sample has been heated to evaporate the water by an oven for finding the contamination quantities. After cooling down, the plate including remaining solids has been weighed. In case of alkaline sample, the obtained solid weight has been minused by weight of sodium hydroxide which determined from basic concentration which known from the first part of data collection.

#### **4.3.2 Microbial data**

Because the cleanliness of the production system directly affects the product cleanliness, we can find that good cleaning operation in the CIP process is one of the important components in the efficient production. Reuse of all or parts of contaminated detergent may produce bad effects. Thus, the microbial quality which is a cleanliness indicator of the detergents has been investigated covering a weekly operation. The details of this part have been explained next.

Same as the previous part, the samples have been collected from three positions of the tanks before and after chemical cleaning operation in invented pilot plant and real cleaning process in the plant.

##### ***Microbial data collection from real plant***

Since the CIP cleaning operation are divided into 2 periods as mentioned above, before the production start in the early morning and after the production end in the evening, the samples gathered in a day have been listed as follows.

##### ***Alkaline sample collection***

1. Before alkali cleaning in the CIP process operated after the production end.



2. After alkali cleaning in the CIP process operated after the production end.

#### *Acid sample collection*

1. Before acid cleaning in the CIP process operated before the production start.
2. After acid cleaning in the CIP process operated before the production start.
3. Before acid cleaning in the CIP process operated after the production end.
4. After acid cleaning in the CIP process operated after the production end.



**Figure 4.16** Samples for microbial quality testing in the standard plate count method

When the sample collections had been completed, we have brought these samples to test in laboratory by the standard plate counting method, Appendix C. Normally, The testing volumes of samples used in the SPC method is 1 ml.,  $10^{-1}$  ml.,  $10^{-2}$  ml. and  $10^{-4}$  ml. depend on microbial quantities in each samples. Since conditions of chemicals are quite violent, pH about 2 and 12 for acid and alkaline consecutively at  $85^{\circ}\text{C}$  during cleaning, the countable microorganism quantities decrease to very few number, or not found. Thus, 1ml. and 10 ml. testing volumes have been used in this thesis to increase chances for microorganism founding. The obtained value of the standard plate count method is total viable microbial colonies in chemicals.

*Microbial data collection from pilot plant*



**Figure 4.17** CIP invented pilot plant

A CIP pilot plant has been invented to study the dynamic behavior of microbial quantity in CIP chemicals which used as cleaning agent for 1 week, 1 cycle chemical used or six day real time experiments. According to Figure 4.17, Tank 1 is a model of a process vessel which is an alternate tank. This tank is a model of milk tank and packing machine which are cleaning targets in pilot plant experiment. Tank 2 and Tank 3 are acid and alkaline tanks respectively. In addition, all conditions, such as chemical temperature and concentration and initial contamination of mixture in cleaning target process vessel, which have been used in the pilot plant experiment have received from the summarization of operating data form real plant. The experiment with the invented pilot plant is the CIP cleaning system which duplicates the real plant operation in the chemical cleaning steps, alkaline and acid cleaning, which start from each water rinsing steps finish to the chemical cleaning steps complete.

The experiment in a day in this section can be divided into 2 period as same as cleaning operation in the real plant. A list of chemical cleaning step operated in CIP pilot plant in each period in a day has been explained following.

1<sup>st</sup> period: Before production start

1. Packing machine cleaning with acid detergent.

2<sup>nd</sup> period: After production end

1. Milk tank cleaning with alkaline detergent.
2. Milk tank cleaning with acid detergent.
3. Packing machine cleaning with alkaline detergent.
4. Packing machine cleaning with acid detergent.

The experiment in a day can be described as follows. First, after preparing alkaline, acid detergent and in mixture of water and milk which used as residual water and milk from rinsing steps, the packing machine cleaning with acid detergent before production start is operated. In this step the experiment starts with heating the acid detergent to 85°C. Next, the acid detergent (tank 2) is circulated to CIP pilot plant is operated for 10 minutes. After 10 minutes acid circulation, the experiment in first period is completed.



**Figure 4.18** Chemical heating in CIP pilot plant



**Figure 4.19** Solution circulating when operating circulative cleaning in the CIP pilot plant

In the second period experiment, there are 4 cleaning operation to operate. After checking and adjusting the concentration of alkaline and acid detergent, the same sub-procedure in the first period is operated. Following experiment procedures have been operated. First of all, the alkaline detergent is heated and then circulated to tank 1. Second, the acid detergent is heated and circulated to tank 1. Then, the alkaline detergent is heated and then circulated to tank 1 again. Lastly, the acid detergent is heated and circulated to tank 1. After the final CIP process in pilot plant of the second period finished the experiment in a day is completed.

In the pilot plant experiment, the samples are collected and sent to laboratory to test with standard plate counting method before the detergents are used in each day, acid and alkaline samples are collected before acid used in the first period cleaning and before alkaline used in the second period cleaning experiments respectively.

#### 4.4 Optimization

To save the cleaning chemicals, an actual method, whole volume discharged, has been replaced by the optimization method. The objective function is formulated to minimize alkali and acid consumptions in any time periods. In this work, the monthly-consumed chemicals have been considered. Thus, the numbers of cleaning cycle,  $n$ , in a month have been defined as 48 and 72 times for alkali and acid consequently. The draining ratio,  $D$ , is a decision variable. The optimizations have been processing under process model constraints and limitations of maximum contaminants and minimum concentrations.

The optimizations have determined the optimal draining ratios of two cases. The alkali cleaning has been considered in the **Case I** and the acid cleaning in the **Case II**. The problem formulation can be generated as following.

##### **Case I** Alkaline cleaning

$$\text{Min}_D \sum_{j=1}^n B(j) \quad (4.9)$$

Where

$$B(j) = V_c(j)(C_{\text{target}} - (1-D)C_{\text{cf}}(j-1)) \quad (4.10)$$

$$W = \sum_{j=1}^n w(j) = \sum_{j=1}^n (D(j)V_c(j)) \quad (4.11)$$

Subject to

$$\frac{dV_c}{dt} = F_{ic} - F_{oc} \quad (4.12)$$

$$\frac{dC_c}{dt} = \frac{F_{ic}(1-\beta)}{V} (C_{ic} - C_{oc}) \quad (4.13)$$

$$\frac{dX_c}{dt} = \frac{F_{ic}(1-(\beta+\mu))}{V} (X_{ic} - X_{oc}) \quad (4.14)$$

$$\frac{dV_e}{dt} = F_{oe} - F_{ie} \quad (4.15)$$

$$\frac{dC_e}{dt} = \frac{F_{ie}}{V_e} (C_{oe} - C_{ie}) \quad (4.16)$$

$$\frac{dX_e}{dt} = \frac{F_{ie}}{V_e} (X_{oe} - X_{ie}) \quad (4.17)$$

$$C_{ie} = C_{oc} = \beta C_{ic} + (1-\beta) C_c \quad (4.18)$$

$$X_{ie} = X_{oc} = (\beta+\mu) X_{ic} + (1-(\beta+\mu)) X_c \quad (4.19)$$

$$C_{ic} = C_{oe} \quad (4.20)$$

$$X_{ic} = X_{oe} \quad (4.21)$$

$$N_{cf}(j) = N_{ci}(j) \times R \quad (4.22)$$

$$C_{ci}(j+1) = \begin{cases} C_{cf}(j) & \text{if } \text{rem}(j,n) \neq 0 \text{ and } C_{cf}(j) > 1 \\ C_{\text{target}} & \text{if } \text{rem}(j,n) \neq 0 \text{ and } C_{cf}(j) < 1 \\ C_{\text{target}} & \text{if } \text{rem}(j,n) = 0 \end{cases} \quad (4.23)$$

$$X_{ci}(j+1) = \begin{cases} X_{cf}(j) & \text{if } \text{rem}(j,n) \neq 0 \\ 0 & \text{if } \text{rem}(j,n) = 0 \end{cases} \quad (4.24)$$

And

$$N_{ci}(j+1) = \begin{cases} 2^k \times N_{cf}(j) & \text{if } \text{rem}(j,n) \neq 0 \\ 0 & \text{if } \text{rem}(j,n) = 0 \end{cases} \quad (4.25)$$

$$C_c \leq C_{\min} \quad (4.26)$$

$$X_c \leq X_{\max} \quad (4.27)$$

$$N_c \leq N_{\max} \quad (4.28)$$

$$0 \leq D \leq 1 \quad (4.29)$$

### **Case II** Acid cleaning

$$\text{Min}_D \sum_{j=1}^n A(j) \quad (4.30)$$

Where

$$A(j) = V_c(j)(C_{\text{target}} - (1-D)C_{\text{cf}}(j-1)) \quad (4.31)$$

$$W = \sum_{j=1}^n w(j) = \sum_{j=1}^n (D(j)V_c(j)) \quad (4.32)$$

Subject to

$$\frac{dV_c}{dt} = F_{ic} - F_{oc} \quad (4.33)$$

$$\frac{dC_c}{dt} = \frac{F_{ic}(1-\beta)}{V} (C_{ic} - C_{oc}) \quad (4.34)$$

$$\frac{dX_c}{dt} = \frac{F_{ic}(1-(\beta+\mu))}{V} (X_{ic} - X_{oc}) \quad (4.35)$$

$$\frac{dV_e}{dt} = F_{oe} - F_{ie} \quad (4.36)$$

$$\frac{dC_e}{dt} = \frac{F_{ie}}{V_e} (C_{oe} - C_{ie}) \quad (4.37)$$

$$\frac{dX_e}{dt} = \frac{F_{ie}}{V_e} (X_{oe} - X_{ie}) \quad (4.38)$$

$$C_{ie} = C_{oc} = \beta C_{ic} + (1-\beta) C_c \quad (4.39)$$

$$X_{ie} = X_{oc} = (\beta+\mu) X_{ic} + (1-(\beta+\mu)) X_c \quad (4.40)$$

$$C_{ic} = C_{oe} \quad (4.41)$$

$$X_{ic} = X_{oe} \quad (4.42)$$

$$N_{cf}(j) = N_{ci}(j) \times R \quad (4.43)$$

$$C_{ci}(j+1) = \begin{cases} C_{cf}(j) & \text{if } \text{rem}(j,n) \neq 0 \text{ and } C_{cf}(j) > 1 \\ C_{\text{target}} & \text{if } \text{rem}(j,n) \neq 0 \text{ and } C_{cf}(j) < 1 \\ C_{\text{target}} & \text{if } \text{rem}(j,n) = 0 \end{cases} \quad (4.44)$$

$$X_{ci}(j+1) = \begin{cases} X_{cf}(j) & \text{if } \text{rem}(j,n) \neq 0 \\ 0 & \text{if } \text{rem}(j,n) = 0 \end{cases} \quad (4.45)$$

And

$$N_{ci}(j+1) = \begin{cases} 2^k \times N_{cf}(j) & \text{if } \text{rem}(j,n) \neq 0 \\ 0 & \text{if } \text{rem}(j,n) = 0 \end{cases} \quad (4.46)$$

$$C_c \leq C_{\min} \quad (4.47)$$

$$X_c \leq X_{\max} \quad (4.48)$$

$$N_c \leq N_{\max} \quad (4.49)$$

$$0 \leq D \leq 1 \quad (4.50)$$

To maintain the quality in cleaning of chemicals,  $C_{\min}$  and  $X_{\max}$  are set to the same values with plant simulation data.



## CHAPTER V

### RESEARCH RESULT

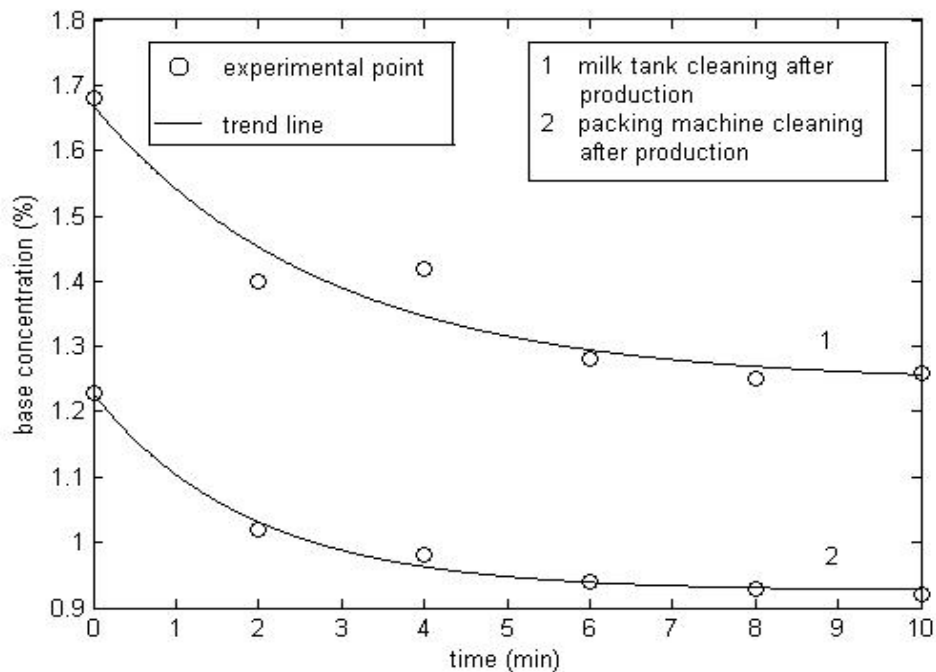
This chapter has been divided into two parts as follows.

#### 5.1 Model of Cleaning In Place Process in the Dairy Plant

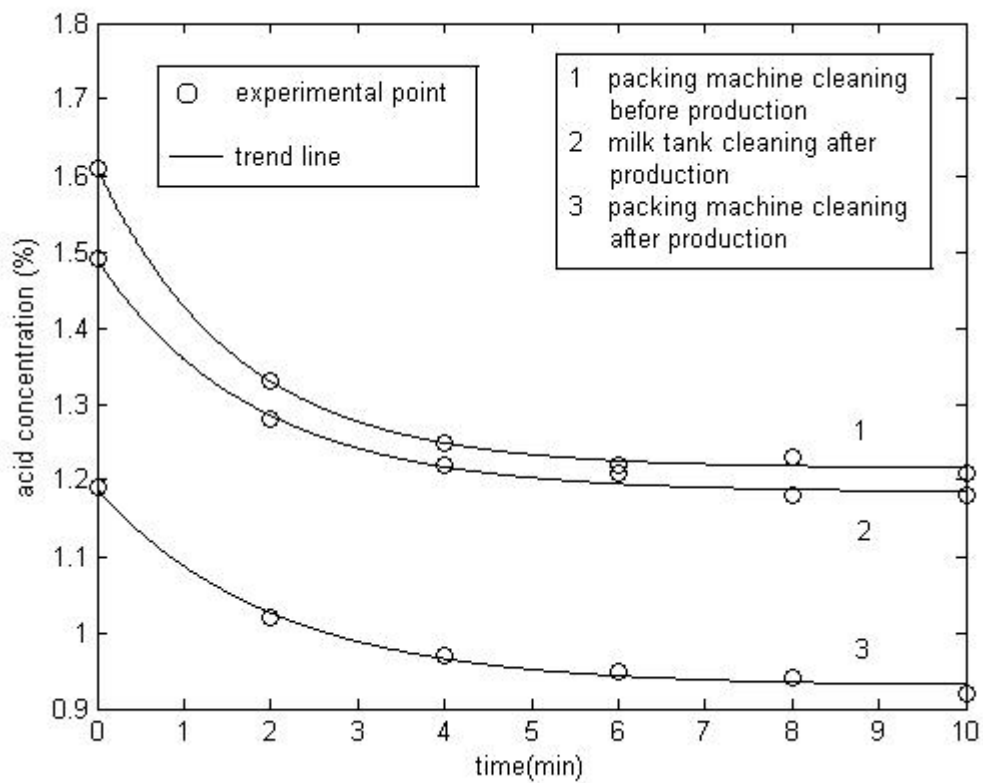
In this part, the result of data collection has been shown. Then, the values of parameters and initial conditions have been estimated from summarization of the collected data. After that, the dynamic behaviors of concentration and contamination of CIP cleaning detergents during plant cleaning operation have been illustrated by developed mathematical models.

##### 5.1.1 Result of data collection

*Result of concentration data collection*



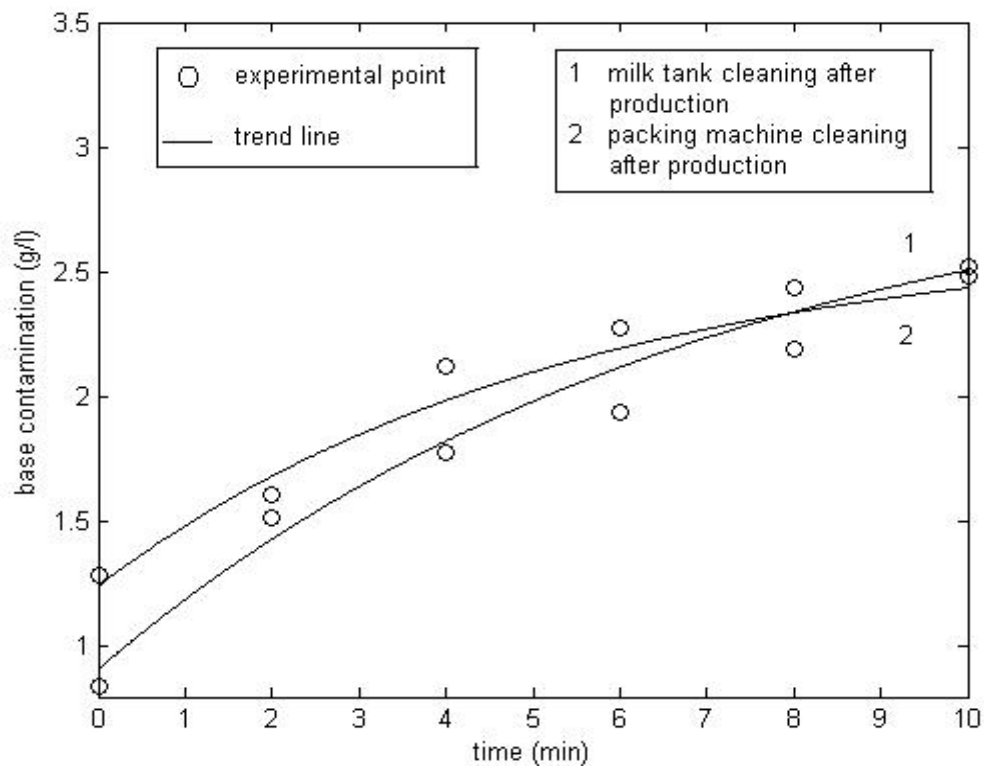
**Figure 5.1** Concentration of alkaline detergent during 10 minutes milk tanks and packing machines cleaning after the production.



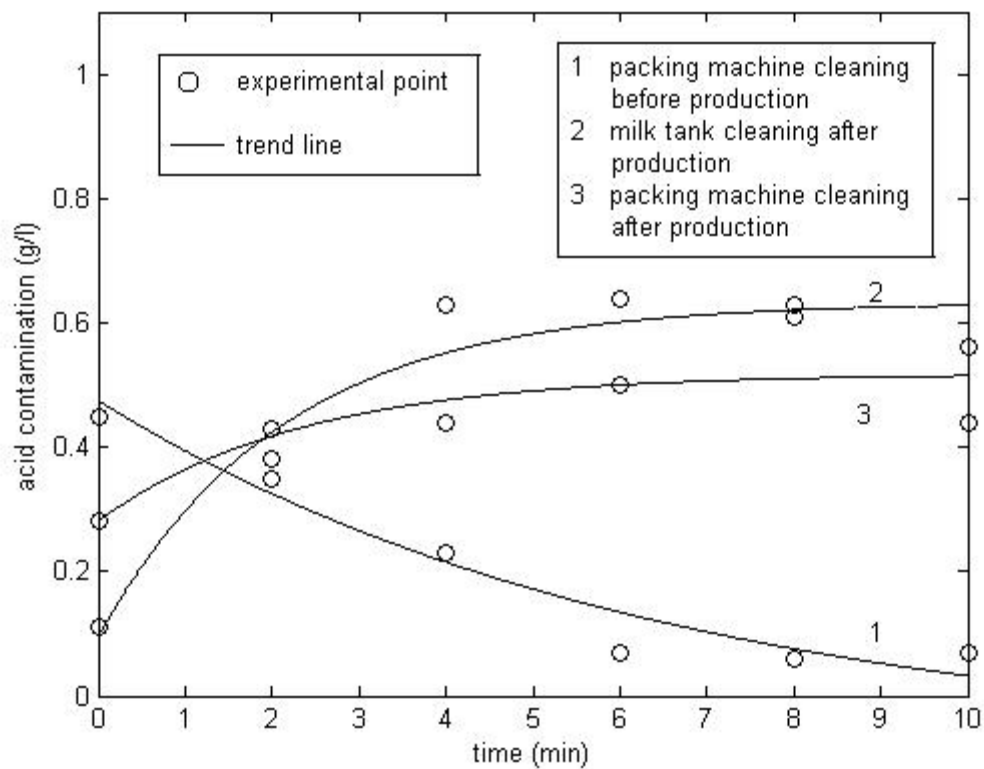
**Figure 5.2** Concentration of acid detergent during 10 minutes packing machines cleaning before the production and milk tanks and packing machines after the production.

Figures 5.1-5.2 show the results of the data collection of concentration. The five from six days cleaning operation data which are the most reliable data sets have been averaged to find the decreasing trend of concentration. Because of mix up between the cleaning detergent and residual water which has less concentration during cleaning circulation, the chemical concentration of cleaning detergent in CIP tank continuously decrease and converges to any value by time.

*Result of contamination data collection*



**Figure 5.3** Contamination of alkaline detergent during 10 minutes pasteurized milk tanks and packing machines cleaning after the production.



**Figure 5.4** Contamination of acid detergent during 10 minutes packing machines cleaning before the production and milk tanks and packing machines after production.

Figures 5.3-5.4 show the results of the data collection of contamination. Same as a previous part, the average point of the collected data which is the most reliable data sets from six days cleaning operation have been shown. The contamination quantities of cleaning detergents in CIP tanks have increasing tendencies for milk tanks and packing machines cleaning with alkaline and acid after the ends of the productions whereas it has a decreasing tendency for packaging machines cleaning before the production because there is no milk curd or film which are main contaminations in the system yet.

*Result of microbial data collection*

The experiments in this part have been performed to check the cleanliness of chemicals which effect to the cleaning qualities. The microbial data have been collected from an invented pilot plant with a condition which is duplicated from real plant operation.

- Pilot plant microbial data

**Table 5.1** The result of standard plate count for detergents

Day	Microorganism count (cfu)			
	Alkali detergent		Acid detergent	
	1 ml	10 ml	1 ml	10 ml
1	0	0	0	0
2	0	0	0	0
3	0	0	0	0
4	0	0	0	0
5	0	0	0	0
6	0	0	0	0
7	0	0	0	0
8	0	0	0	0

- Real plant microbial data

**Table 5.2** The result of standard plate count for alkaline detergent in regular capacity operation day

Day	Microorganism count (cfu)			
	Before production		After production	
	1 ml	10 ml	1 ml	10 ml
1	0	0	1	0
3	0	0	1	0
4	2	0	1	0
5	0	0	0	0
6	0	0	0	0

**Table 5.3** The result of standard plate count method for alkali detergent in non-operation day

Day	Microorganism count (cfu)			
	Before production		After production	
	1 ml	10 ml	1 ml	10 ml
2	0	0	1	0
7	0	0	-	-

**Table 5.4** The result of standard plate count for acid detergent in regular capacity operation day

Day	Microorganism count (cfu)							
	Before production		After production		Before production		After production	
	1 ml	10 ml	1 ml	10 ml	1 ml	10 ml	1 ml	10 ml
1	0	0	0	0	0	1	0	0
3	0	0	0	0	0	0	0	0
4	0	0	0	0	0	0	1	0
5	0	0	0	0	0	0	0	0
6	0	0	0	0	0	0	0	0

**Table 5.5** The result of standard plate count method for acid detergent in non-operation day

Day	Microorganism count (cfu)			
	Morning		Afternoon	
	1 ml	10 ml	1 ml	10 ml
2	0	0	0	0
7	0	0	-	-

The microbial data of cleaning detergent during 8 days, 6 regular cleaning operation days (Day 1-6), a day with no cleaning (Day 7) and the 1<sup>st</sup> day of next week (Day 8), has been listed on the table 5.1. The results show that the cleaning detergents, both alkali and acid, under an experiment condition in the invented pilot plant are very clean because bacteria or other microorganisms cannot be found from testing, standard plate count method, in all samples.

Similarly, although not all, almost data in the table 5.2-5.5 which have been gathered from real plant operation have values as zero. In addition, we have found from remaining data that maximum microorganism are only 2 and 1 colony form unit (cfu) in 1 milliliter of alkali and acid detergent respectively while the maximum

microorganism quantity of high quality pasteurized milk with standard plate count testing method is 1,000 cfu/ml.

Since the microorganism quantities under the cleaning conditions, both pilot plant and real plant operation, are very few and this residual microorganism in chemicals, maximum 2 and 1 cfu in alkali and acid detergents mentioned above, can be sanitized and removed by hot water in each next water rinsing steps, This cause can confirm that under actual cleaning condition the microorganism in the cleaning detergents cannot remain in the system and also cannot effect to the product cleanliness and quality. Thus, the microbial quantity data has not been considered in the optimization solving process.

### **5.1.2 Process parameters and initial condition**

The parameters and initial condition of process which have been expressed in equations 4.1 to 4.12 have been determined from summarization of real and pilot plant operation data. And, their values have been listed on the table 5.6-5.7.

**Table 5.6** Parameters and initial conditions of the plant cleaning operation

Parameters and initial condition	Values	Units
T	10	min.
n	12 (milk tank cleaning) 18 (packing machine cleaning)	time
$F_{ic}$	200.36 (milk tank cleaning) 101.32 (packing machine cleaning)	L/min.
$F_{oc}$	200.36 (milk tank cleaning) 101.32 (packing machine cleaning)	L/min.
$F_{ie}$	200.36 (milk tank cleaning) 101.32 (packing machine cleaning)	L/min.
$F_{oe}$	200.36 (milk tank cleaning) 101.32 (packing machine cleaning)	L/min.
$V_c$	500.00	L.
$C_{target}$	1.69	%(m/v.)
$C_c(0)$	1.69	%(m/v.)
$C_e(0)$	0	%(m/v.)
$X_c(0)$	0	g/L.
$X_e(0)$	3.27 (alkali cleaning) 0.73 (acid cleaning)	g/L.

**Table 5.7** The average values of remaining volume of the residual water in each steps

Period	Cleaning step	Detergent	$V_e$ (liter)
Before production	Packing machines	Acid	161.63
After production	Milk tanks	Base	160.34
	Packing machines	Base	161.85
	Milk tanks	Acid	128.06
	Packing machines	Acid	137.92

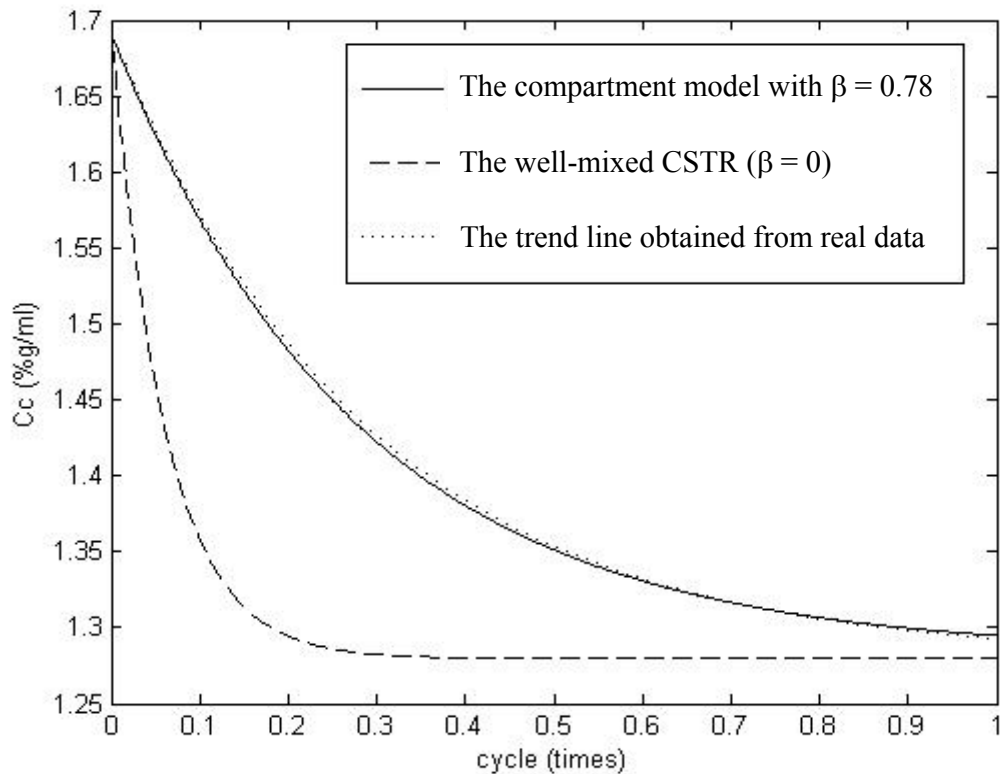


The chemical cleaning step is operated 10 minutes circulation and 12 and 18 cleaning times in a week, six days operations. The inlet and outlet flowrates of CIP chemical tanks have been measured and their average values are 200.36 and 101.32 l/min. for pasteurized milk tanks and packing machines cleaning respectively and quite constant during the cleaning operation. Since the system has very little leakage, the remaining volume has been determined from the different of initial and final concentration of chemicals. According to Table 5.7, the average values of remaining volume of the residual water are 161.63 liter for acid cleaning step to clean packing machines before the production, 160.34 liter and 161.85 liter for milk tanks and packing machines cleaning with alkaline detergent after the production consecutively and 128.06 liters and 137.92 liters for milk tanks and packing machines cleaning with acid detergent after the production respectively while chemicals volume in CIP tank is 500 liter.

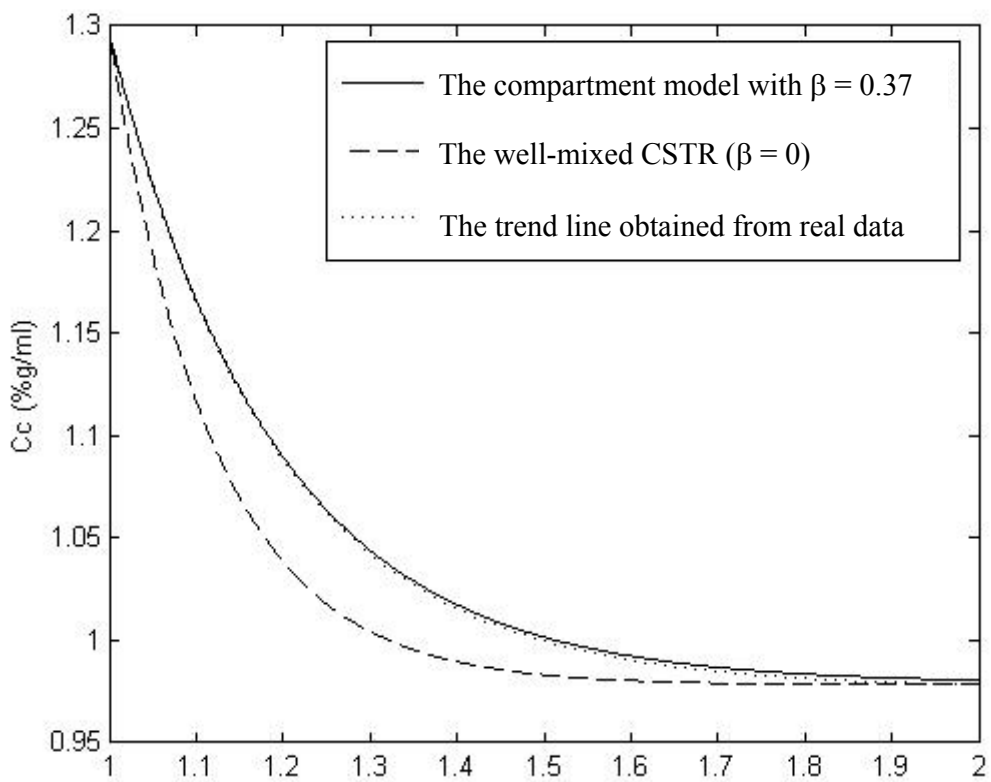
The average target concentration when detergent concentrations are adjusted and initial concentration is 1.69%, mass by volume, equally for alkali and acid. And, since the initial concentrations of chemicals in residual water from each water rinsing steps and the initial contamination of chemical detergents are very little, their values have been neglected. Because of close system cleaning operation, the initial contaminations of the residual water in process equipment have been estimated from final contamination of chemical detergents in CIP tank and the residual volume in each cleaning cycles. The average values have been determined as 3.27 and 0.73 g/L. for alkali and acid cleaning consecutively.

### **5.1.3 Mathematical model of Cleaning In Place process**

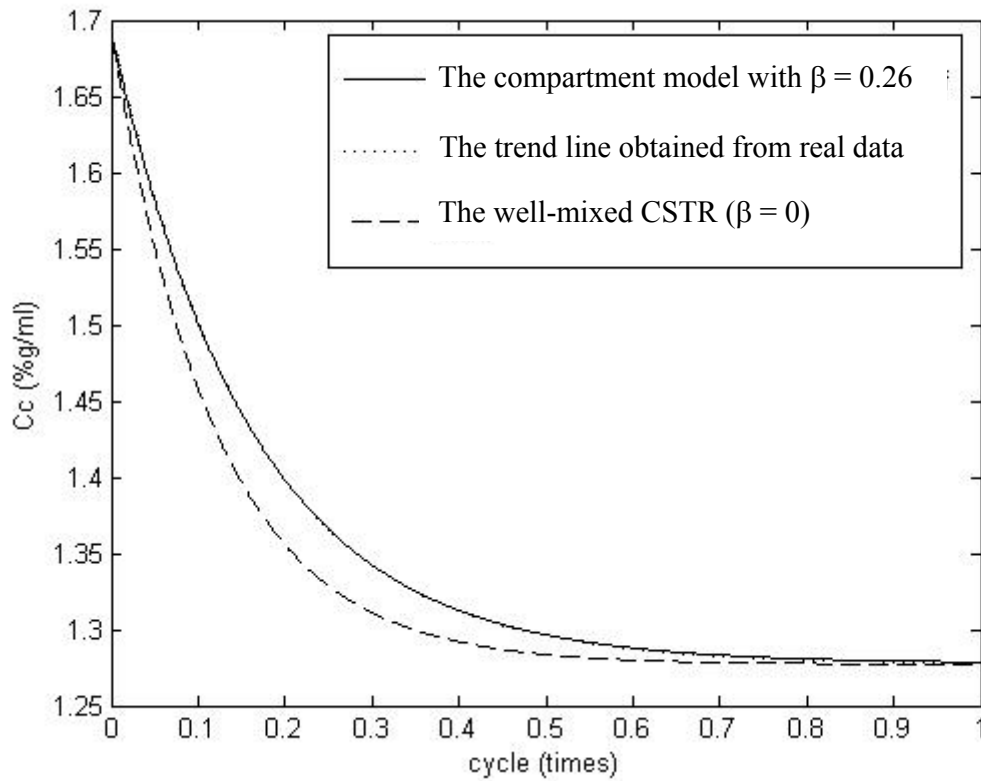
The value of parameters,  $\beta$  and  $\mu$ , are obtained by best fitting between theoretical curve of the compartment model and experimental point. The result of formulating the mixing model is shown as figure 5.5 to 5.14



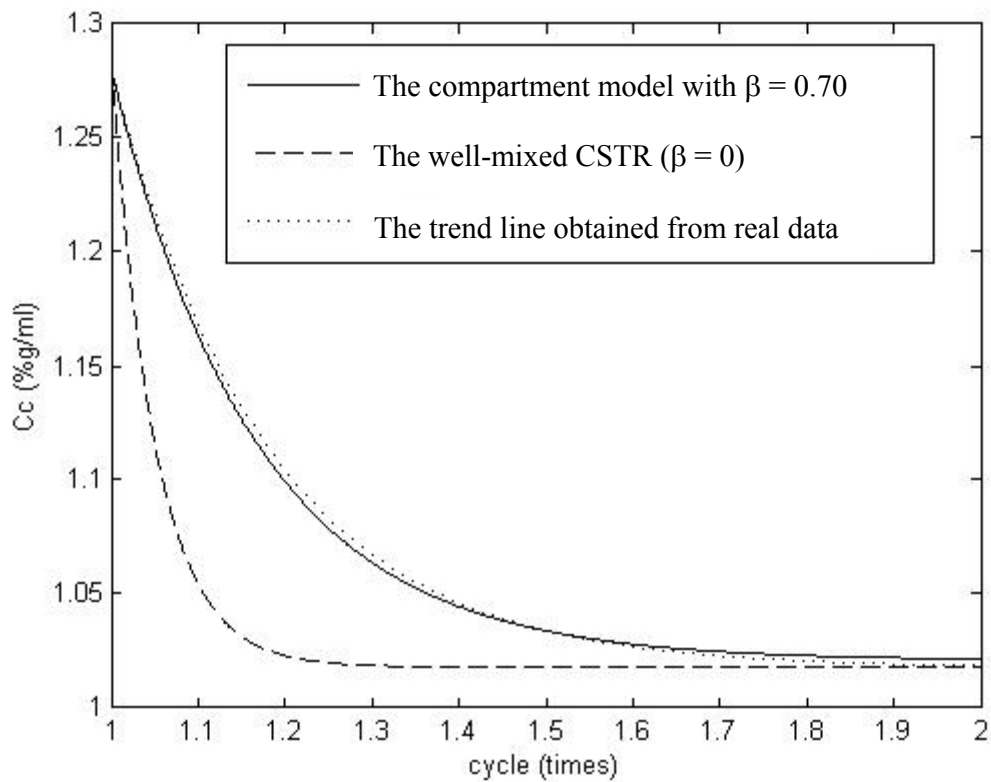
**Figure 5.5** Modeling by the compartment model with  $\beta = 0.78$  of concentration of alkaline detergent during 1 cycle milk tanks cleaning after production.



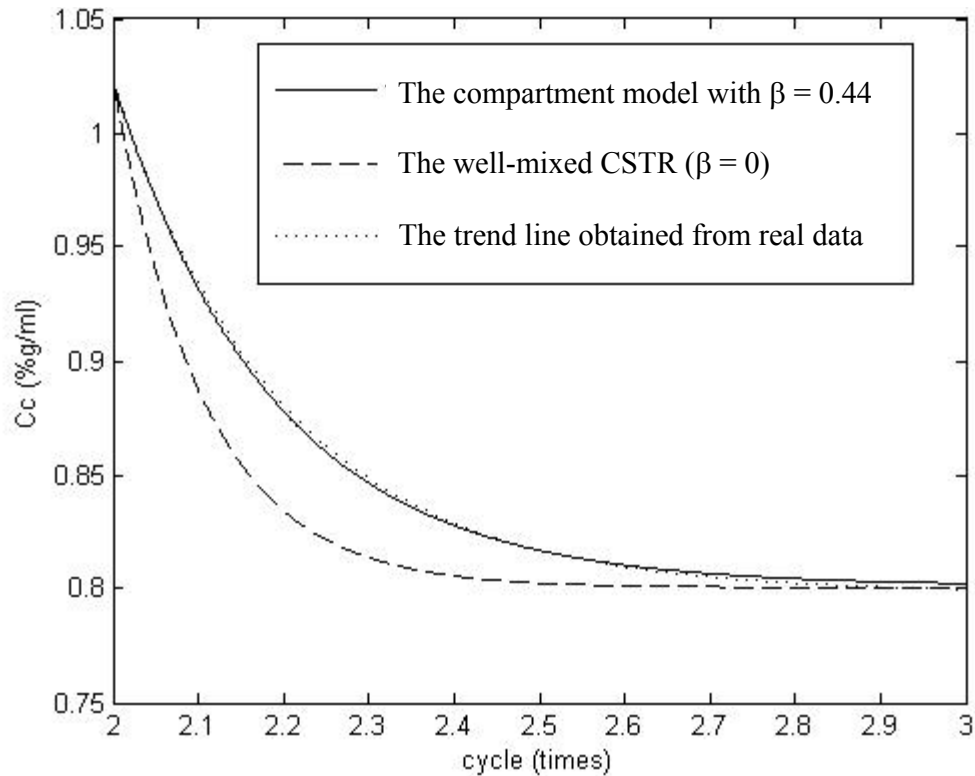
**Figure 5.6** Modeling by the compartment model with  $\beta = 0.37$  of concentration of alkaline detergent during 1 cycle packing machines cleaning after production.



**Figure 5.7** Modeling by the compartment model with  $\beta = 0.26$  of concentration of acid detergent during 1 cycle packing machines cleaning before production.

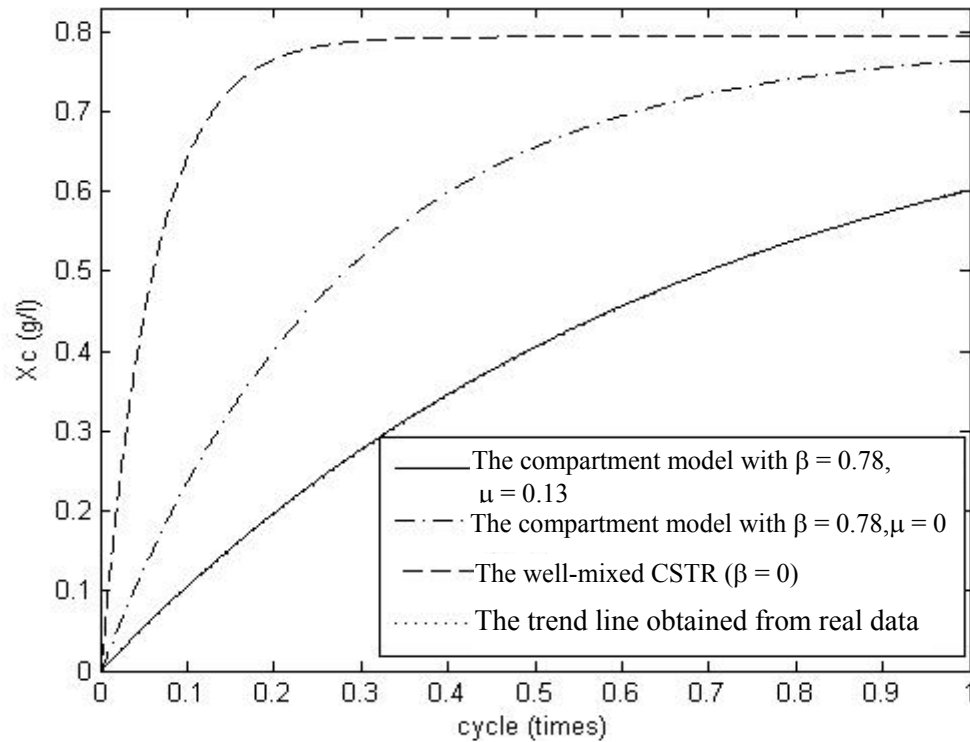


**Figure 5.8** Modeling by the compartment model with  $\beta = 0.70$  of concentration of acid detergent during 1 cycle milk tanks cleaning after production.

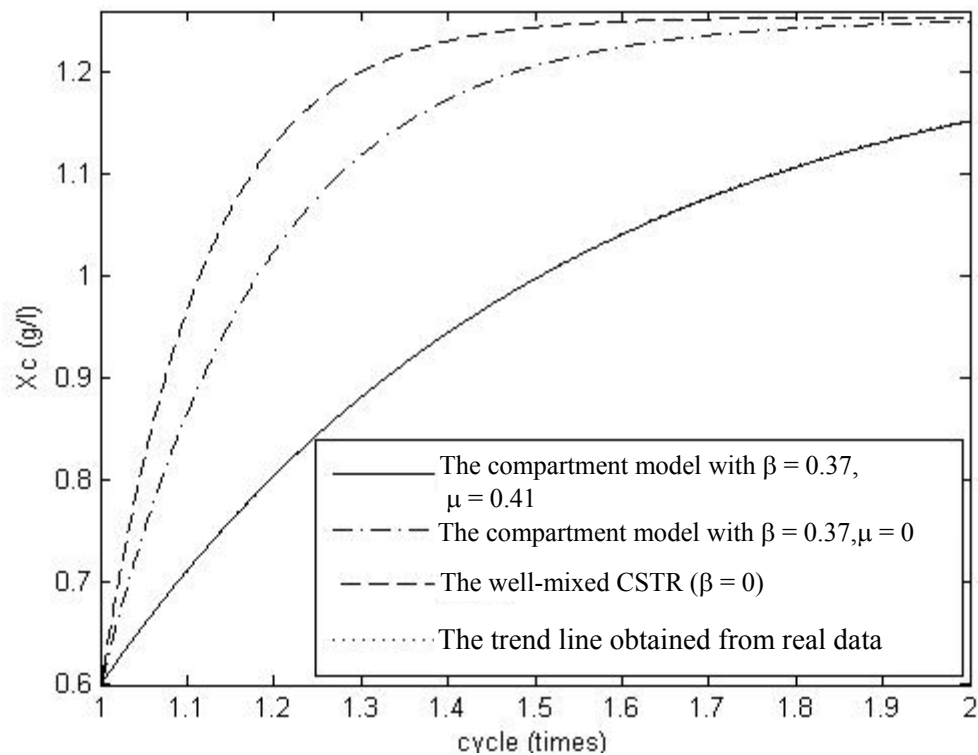


**Figure 5.9** Modeling by the compartment model with  $\beta = 0.44$  of concentration of acid detergent during 1 cycle packing machines cleaning after production.

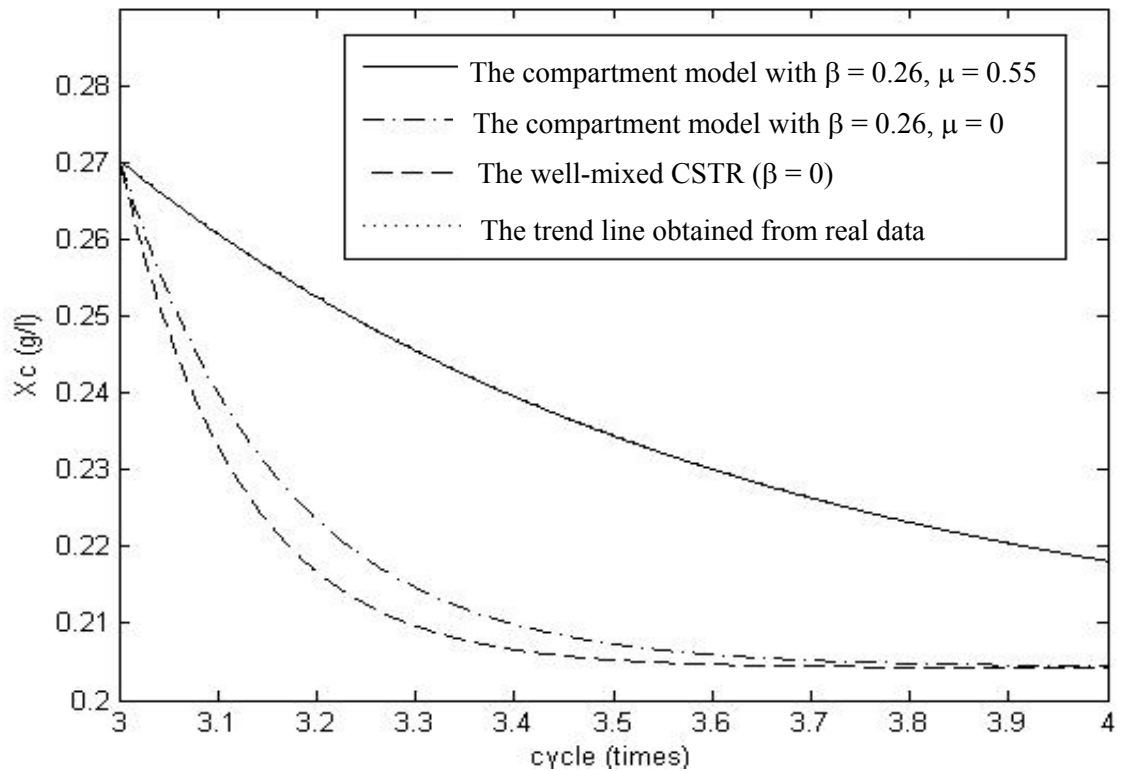
Figures 5.4-5.9 show the chemical concentration decreases which occur from mixing of the chemicals and the residual water in the chemical tanks. The solid line in the figure represents the change of the chemical concentration modeled by the compartment model. The dash line represents the change of the chemical concentration modeled by the well-mixed CSTR which is the ideal mixing. And, the point line represents the change of the chemical concentration obtained from real data. In these figure, the imperfect mixing coefficient, the ratio of the bypass steam affected from the size of flowrate  $\beta$ , can be determined from the best fit of the compartment model curve to the real data curve. The parameters in each case are shown in the table 5.8.



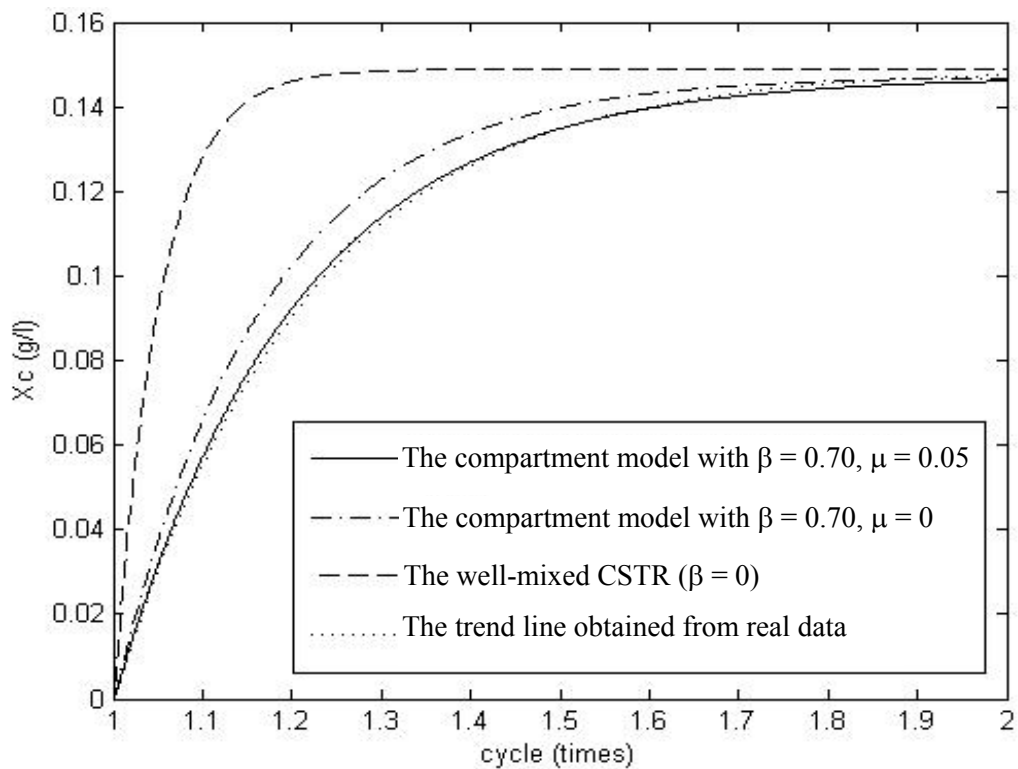
**Figure 5.10** Modeling by the compartment model with  $\beta = 0.78$  and  $\mu = 0.13$  of contamination of alkaline detergent during 1 cycle milk tanks cleaning after production.



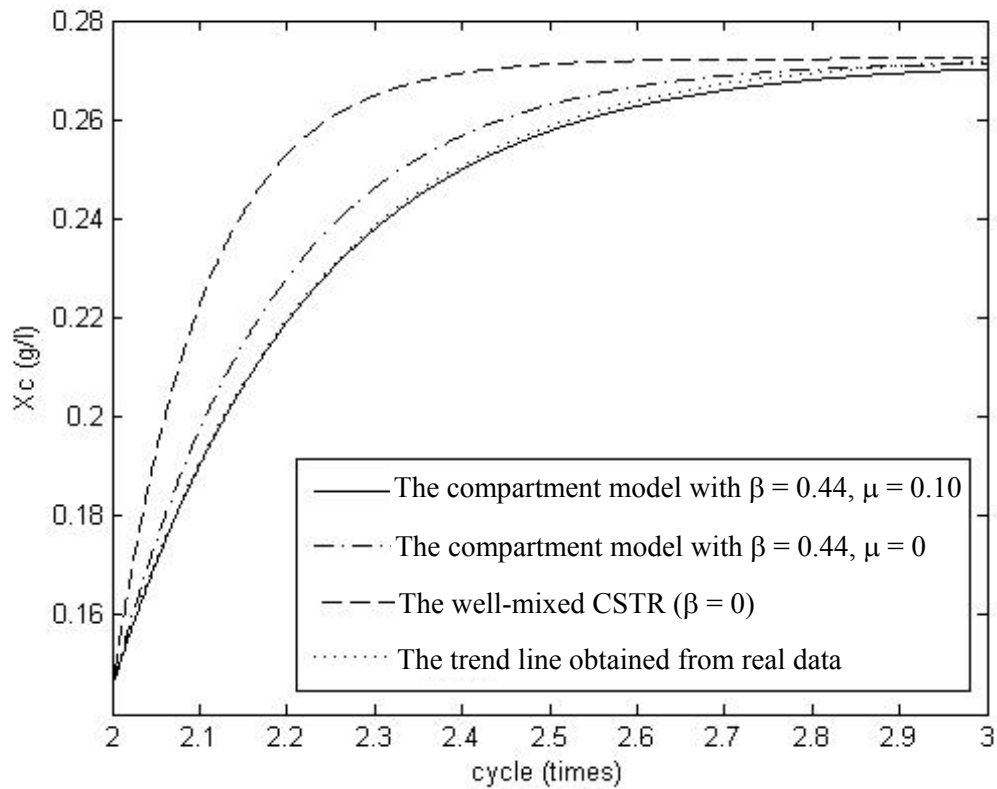
**Figure 5.11** Modeling by the compartment model with  $\beta = 0.37$  and  $\mu = 0.41$  of contamination of alkaline detergent during 1 cycle packing machines cleaning after production.



**Figure 5.12** Modeling by the compartment model with  $\beta = 0.26$  and  $\mu = 0.55$  of contamination of acid detergent during 1 cycle packing machines cleaning after production.



**Figure 5.13** Modeling by the compartment model with  $\beta = 0.70$  and  $\mu = 0.05$  of contamination of acid detergent during 1 cycle milk tanks cleaning after production.



**Figure 5.14** Modeling by the compartment model with  $\beta = 0.44$  and  $\mu = 0.10$  of contamination of acid detergent during 1 cycle packing machines cleaning after production.

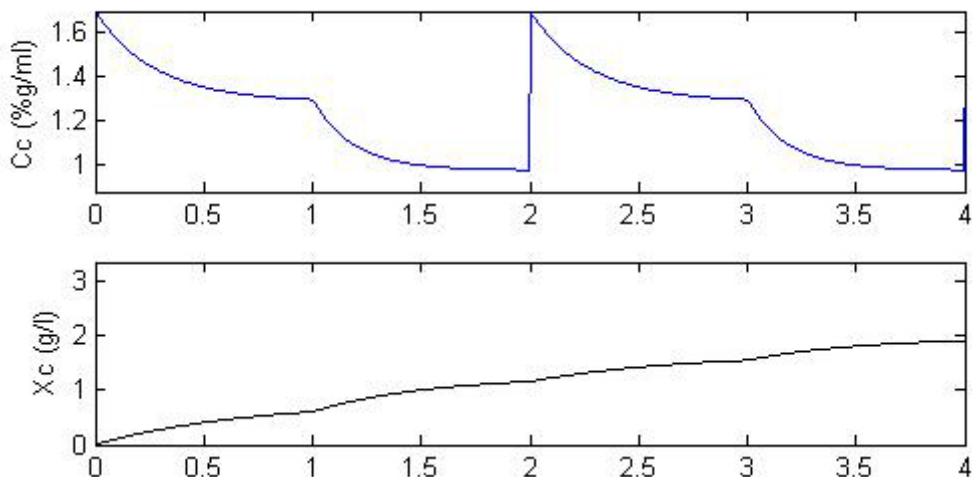
Figures 5.10-5.14 show the variation of contamination of chemical detergents which occur from mixing of the chemicals and the residual water in the chemical tanks during the process cleaning. Same as figure 5.5-5.9, The imperfect mixing coefficient, the ratio of the bypass steam affected from the size of flowrate  $\beta$ , can be determined from the best fit of the compartment model curve to the real data curve. Because of the effect of the imperfect dissolution of contamination, the change which occurs from mixing is slower than the concentration case. Therefore, the second parameter, the ratio of the bypass steam affected from imperfect dissolution of contamination  $\mu$ , must be also evaluated in each case. The solid line in the figure represents the change of the contamination of chemical modeled by the 2 parameter,  $\beta$  and  $\mu$ , compartment model. The pointed-dash line represents the change of the contamination of chemical modeled by the compartment model with only  $\beta$  parameter. The dash line represents the change of the chemical concentration modeled

by the well-mixed CSTR which is the ideal mixing. And, the point line represents the change of the chemical concentration obtained from real data. The parameters in each case are shown in the table 5.8.

**Table 5.8** The parameters of the compartment models.

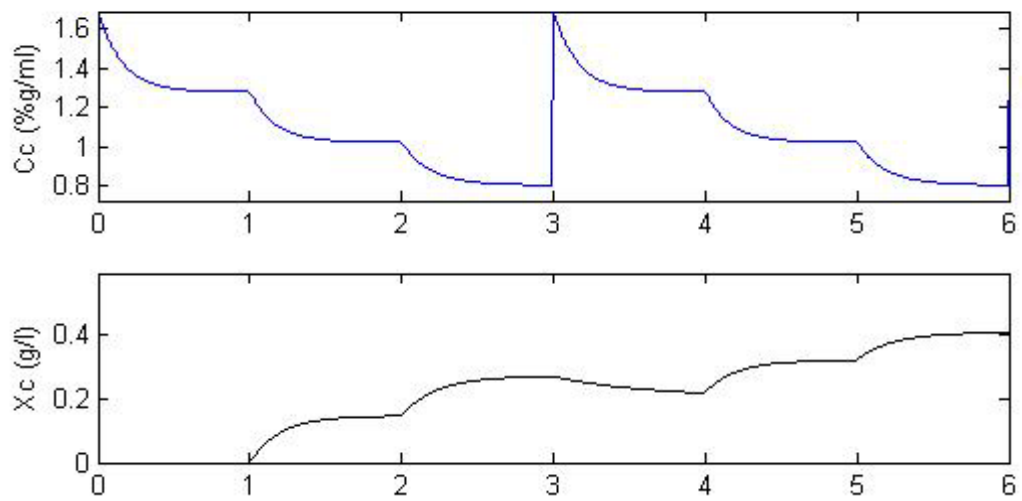
Period	Cleaning step	Detergent	$\beta$	$\mu$
Before production	Packing machines	Acid	0.26	0.55
After production	Milk tanks	Base	0.78	0.13
	Packing machines	Base	0.37	0.41
	Milk tanks	Acid	0.70	0.05
	Packing machines	Acid	0.44	0.10

From real plant conditions, the data have been summarized and we have obtained the mathematical models which represent the process. The mathematical models illustrate the dynamic behaviors of state variables of the process which are concentration, contamination and draining ratio of chemical detergents during cleaning operation.

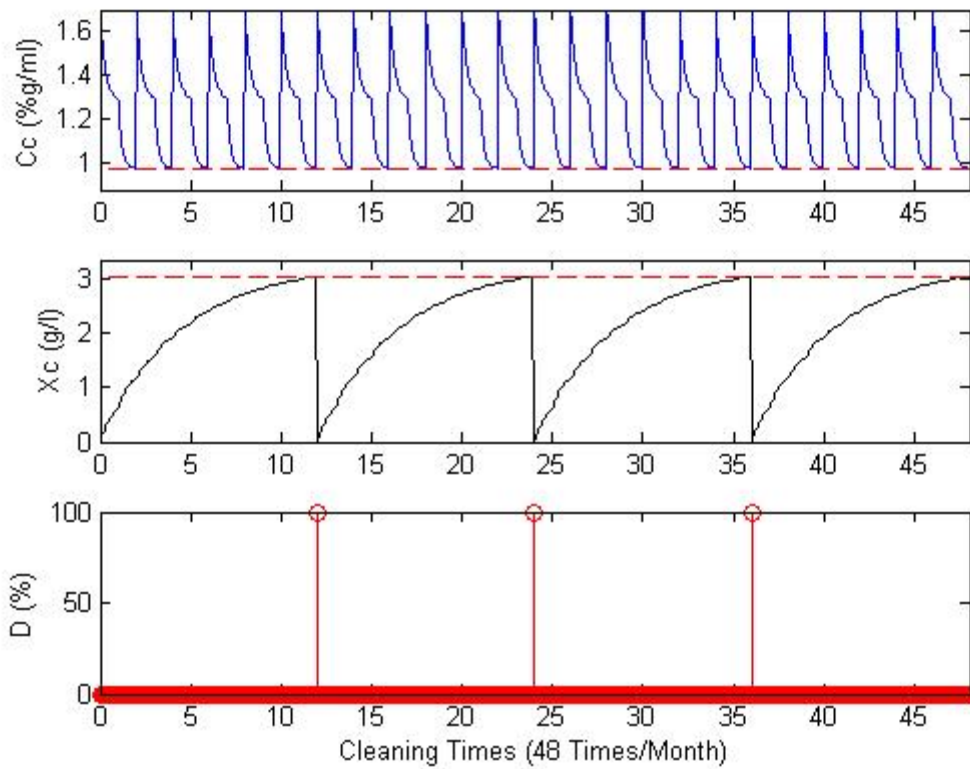


**Figure 5.15** Concentration and contamination of alkali during two days (Four cleaning cycles)

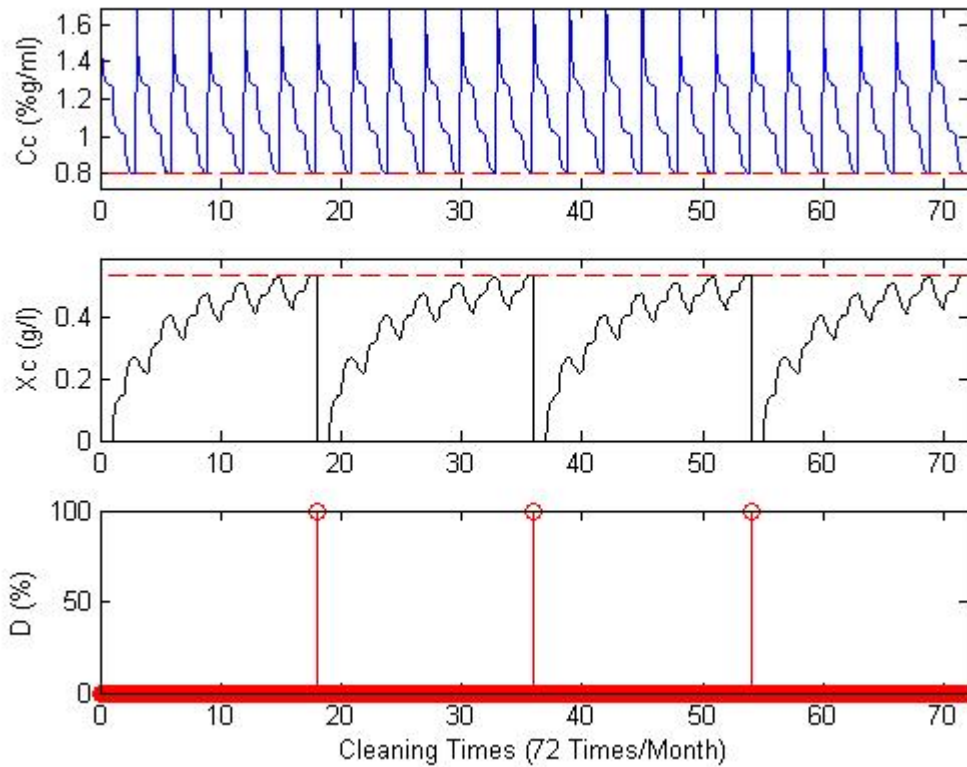




**Figure 5.16** Concentration and contamination of acid during two days  
(Six cleaning cycles)



**Figure 5.17** Concentration and contamination of alkali cleaning and draining ratio for  
the actual method



**Figure 5.18** Concentration and contamination of acid cleaning and draining ratio for the actual method

Figures 5.15-5.18 show the dynamics of concentrations, contaminations and draining ratios of chemical detergents during 4 and 48 cycles, 2 and 24 operation day. Concentrations of alkali and acid detergent start at 1.69 % and decrease continuously during the cleaning cycle. And, when the concentration decreases to the value which less than 1%, the concentration is adjusted to the target concentration. While, the contamination of alkali and acid detergents start at the initial contamination and increase steply during the cleaning to maximum values at the weekly maximum cleaning cycles, the 12<sup>th</sup> and 18<sup>th</sup> cycle for alkali and acid consecutively. After the last cleaning of a week, the whole volume, 100% draining ratio, of chemical detergents is discharged and new chemical solutions are prepared to use for cleaning in the next week. With this reason, the concentrations and contaminations of chemical detergents are refreshed to initial values when new weeks start.

In the actual monthly cleaning operations, the total chemical consumptions of base used in alkaline cleaning step and acid used in acid cleaning step are 154.03

liters and 180.23 liters respectively. In addition, the total water consumptions in alkaline and acid are 2,000 liters.

## 5.2 Optimization

In this thesis, optimization problem has been studied in two cases. Case I has focused to the alkaline cleaning optimization problem and Case II has been interested in the acid cleaning optimization problem.

### 5.2.1 Case I alkaline cleaning optimization problem

According to the optimization problem in the section 4.4, we have applied constraints and expressed the problem in this case as following.

$$\text{Min}_D \sum_{j=1}^n B(j) \quad (5.1)$$

Where

$$B(j) = V_c(j)(C_{\text{target}} - (1-D)C_{\text{cf}}(j-1)) \quad (5.2)$$

$$W = \sum_{j=1}^n w(j) = \sum_{j=1}^n (D(j)V_c(j)) \quad (5.3)$$

Subject to

$$\frac{dV_c}{dt} = F_{ic} - F_{oc} \quad (5.4)$$

$$\frac{dC_c}{dt} = \frac{F_{ic}(1-\beta)}{V} (C_{ic} - C_{oc}) \quad (5.5)$$

$$\frac{dX_c}{dt} = \frac{F_{ic}(1-(\beta+\mu))}{V} (X_{ic} - X_{oc}) \quad (5.6)$$

$$\frac{dV_e}{dt} = F_{oe} - F_{ie} \quad (5.7)$$

$$\frac{dC_e}{dt} = \frac{F_{ie}}{V_e} (C_{oe} - C_{ie}) \quad (5.8)$$

$$\frac{dX_e}{dt} = \frac{F_{ie}}{V_e} (X_{oe} - X_{ie}) \quad (5.9)$$

$$C_{ic} = C_{oc} = \beta C_{ic} + (1-\beta) C_c \quad (5.10)$$

$$X_{ic} = X_{oc} = (\beta+\mu) X_{ic} + (1-(\beta+\mu)) X_c \quad (5.11)$$

$$C_{ic} = C_{oe} \quad (5.12)$$

$$X_{ic} = X_{oe} \quad (5.13)$$

$$C_{ci}(j+1) = \begin{cases} C_{cf}(j) & \text{if } \text{rem}(j,n) \neq 0 \text{ and } C_{cf}(j) > 1 \\ C_{\text{target}} & \text{if } \text{rem}(j,n) \neq 0 \text{ and } C_{cf}(j) < 1 \\ C_{\text{target}} & \text{if } \text{rem}(j,n) = 0 \end{cases} \quad (5.14)$$

$$X_{ci}(j+1) = \begin{cases} X_{cf}(j) & \text{if } \text{rem}(j,n) \neq 0 \\ 0 & \text{if } \text{rem}(j,n) = 0 \end{cases} \quad (5.15)$$

$$C_c \leq C_{\min} \quad (5.16)$$

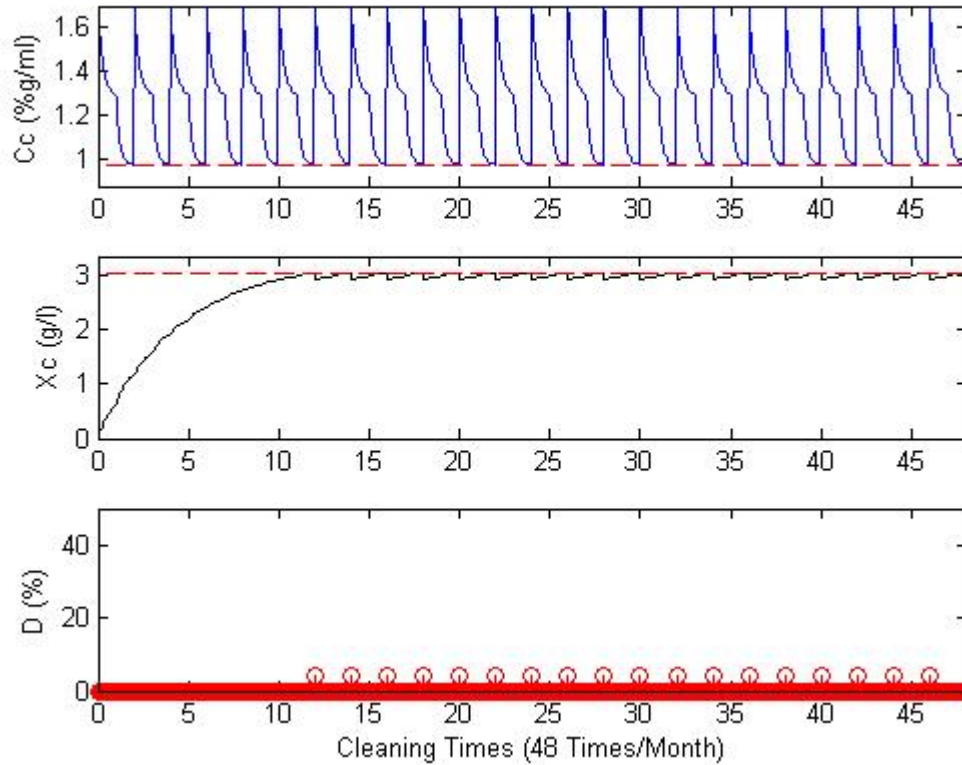
$$X_c \leq X_{\max} \quad (5.17)$$

$$0 \leq D \leq 1 \quad (5.18)$$

To maintain the cleaning quality, the minimum concentration, equation 5.16, and the maximum contamination, equation 5.17, in optimization have been set to the same values as the simulation of the plant actual operation, 0.98 and 3.03 respectively, from the previous section. To obtain the optimal draining ratio, the optimization problem has been solved with every starting point, initial draining ratio for optimization, from 0 to 100 percent draining.

The draining ratios and draining patterns are adjusted to match with the dynamic behaviors of the properties, concentration and contamination, of the alkaline detergent which is used in the alkaline cleaning step under process constraints. The optimization determines the optimal draining ratio that makes the least alkaline discharging whereas the alkaline cleaning process still can maintain the quality completely. The result shows that the optimal draining ratio and the draining pattern for the first case, alkaline cleaning step, is obtained as 4.34% of alkaline volume drained after the 12<sup>th</sup>, 14<sup>th</sup>, 16<sup>th</sup> ... 44<sup>th</sup> and 46<sup>th</sup> cleaning cycles or 2 cycles/time after

1 week pass. The concentration and contamination of alkaline detergent when applying the offered method with the optimal draining ratio during cleaning operation can be illustrated consecutively in following figures.



**Figure 5.19** Concentration and contamination of alkali detergent when applying the offered method with 4.34% draining ratio

The operation result and comparison between the actual and offered methods have been summarized and shown in the table 5.9

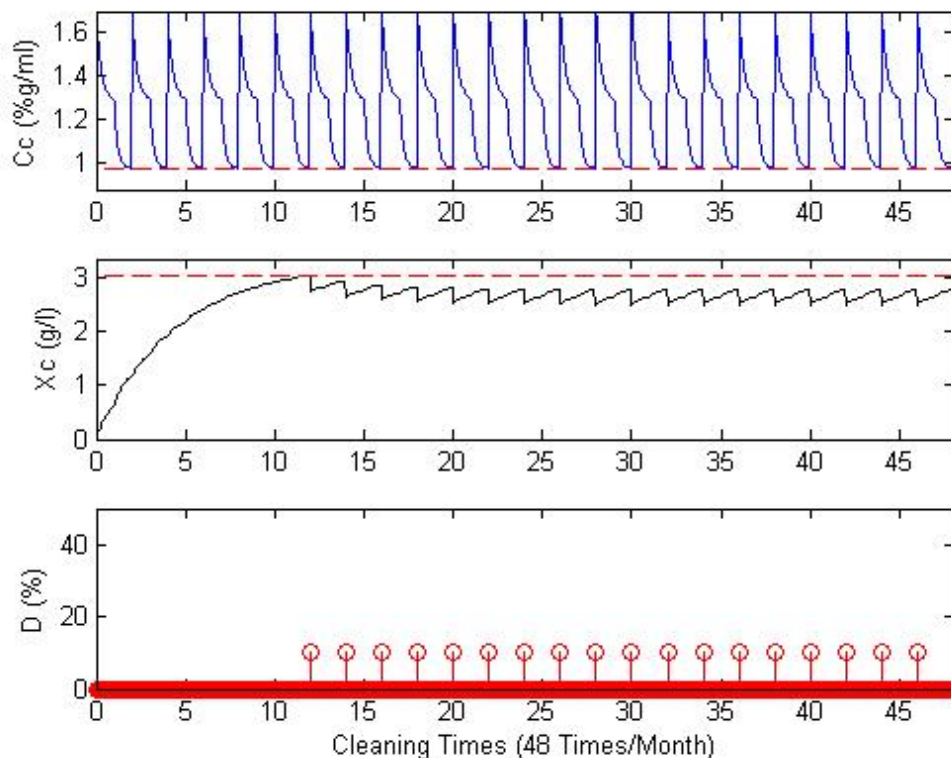
**Table 5.9** Summary and comparison of consumptions between the plant actual method and the offered method with the optimal draining ratio of CIP alkali cleaning step

D (%)	Draining Volume (L.)	Draining time (after cycle)	Duration from last draining	Alkali saving (%)	Water saving (%)	$C_{min}$ (%)	$X_{max}$ (g/L.)
4.34	21.70	12,14,16,...,46	2	10.39	55.49	0.98	3.03
100 (actual)	500	12,24,36	12	-	-	0.98	3.03

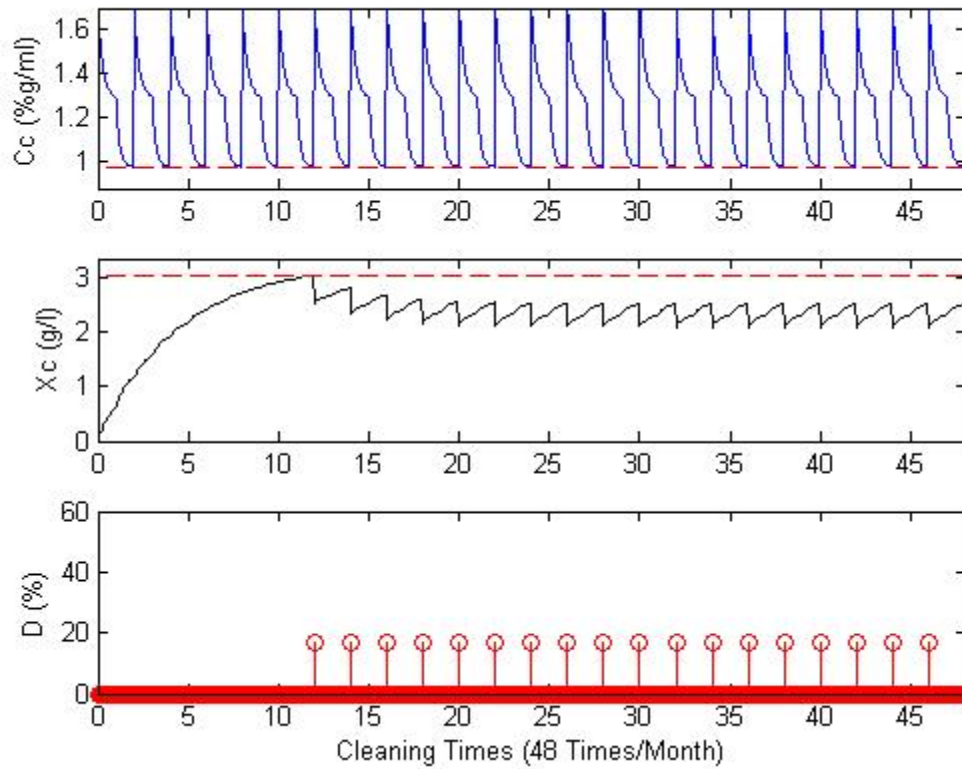
According to table 5.9, we have found that 4.34% of draining ratio, 13.45 liter which generates the draining pattern as draining after 12<sup>th</sup>, 14<sup>th</sup>, 16<sup>th</sup>,..., 44<sup>th</sup> and 46<sup>th</sup> cleaning cycle, 2 cycle/time after 1 week pass, is the optimal solution of case I. Because of the offered method and the obtained optimal draining ratio, the chemical and water used in alkaline cleaning step can be saved 10.39% and 55.49% of the actual consumptions.

### 5.2.1.1 Study of the draining ratio value changes

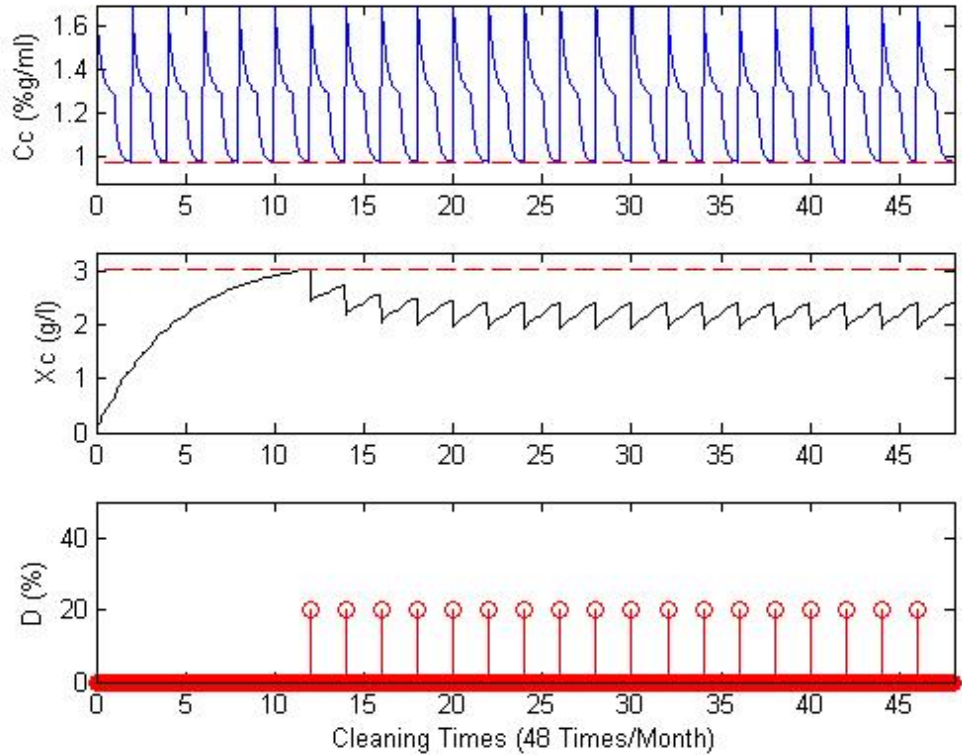
To be alternatives for the real cleaning operation, the effects of variations of the draining ratio have been studied. The concentration and contamination of alkaline detergent in the cleaning operation which applied vary draining ratios in the range of 10%-50% with the same draining pattern of the obtained optimal draining ratio have been shown in figure 5.20-5.25.



**Figure 5.20** Concentration and contamination of alkali detergent when applying 10% draining ratio and draining pattern 2 cycles/time after 1 week pass.

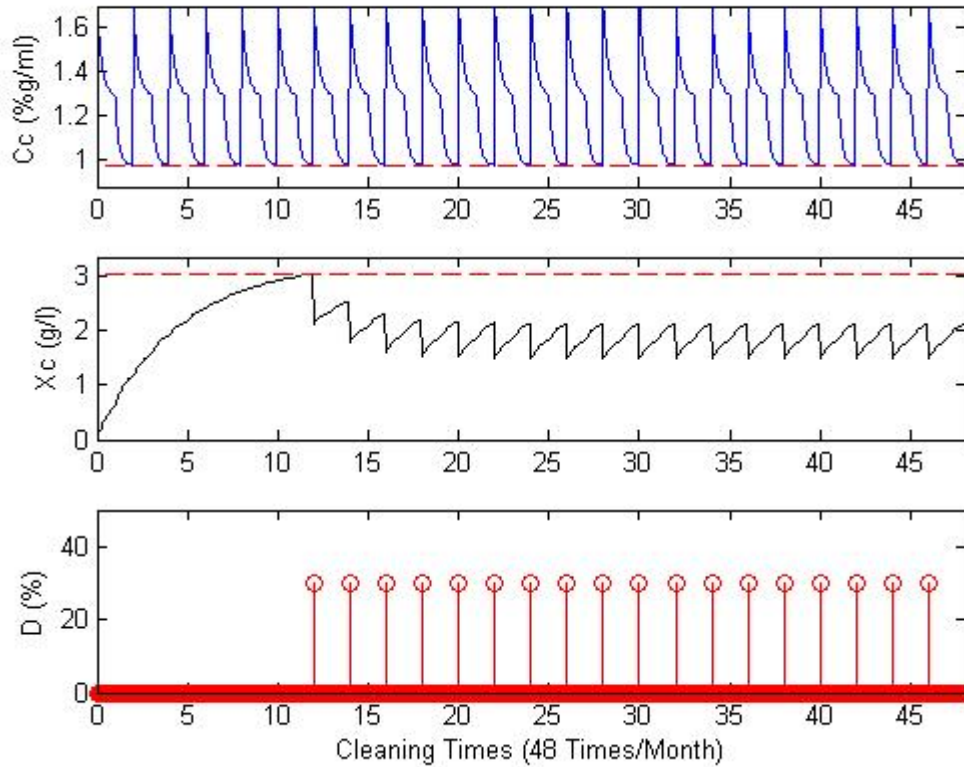


**Figure 5.21** Concentration and contamination of alkali detergent when applying 16.67% draining ratio and draining pattern 2 cycles/time after 1 week pass.

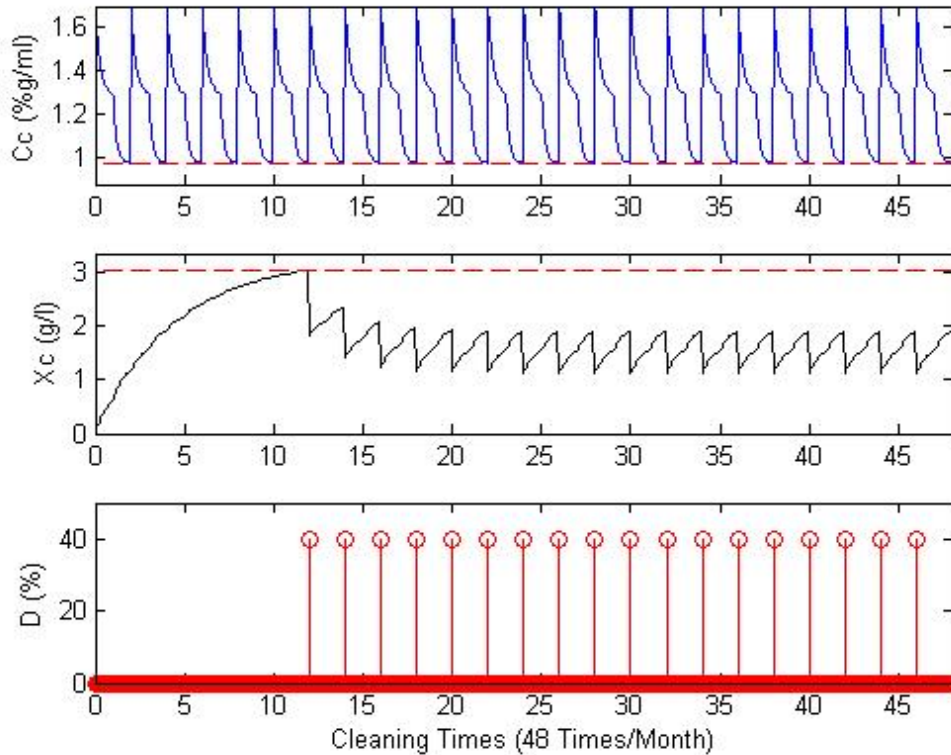


**Figure 5.22** Concentration and contamination of alkali detergent when applying 20% draining ratio and draining pattern 2 cycles/time after 1 week pass.



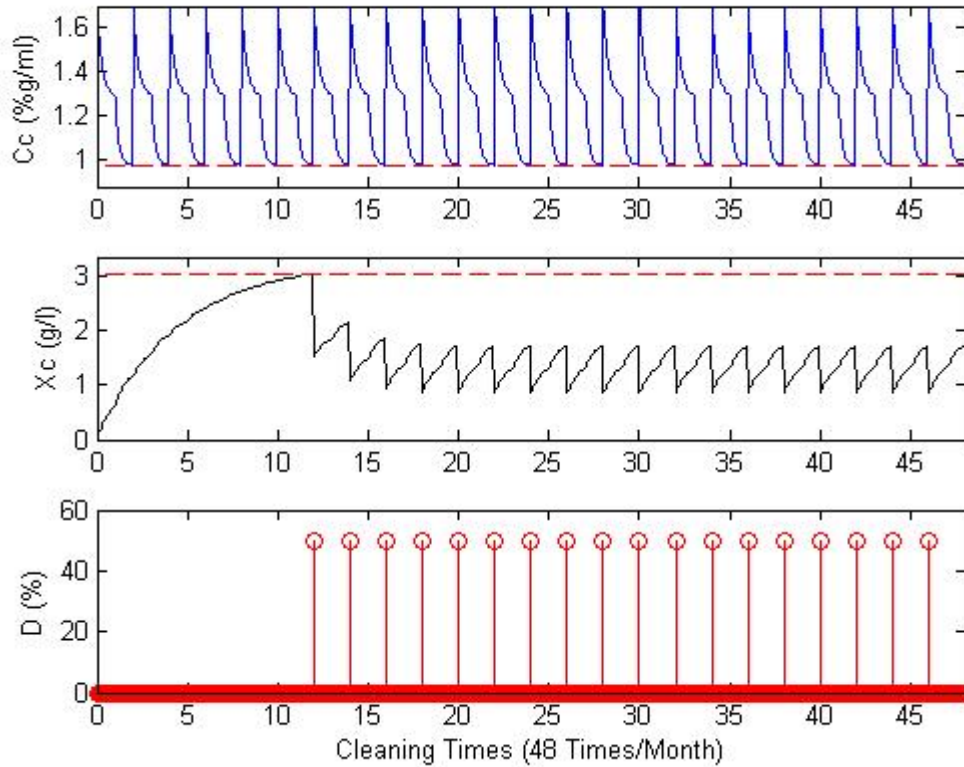


**Figure 5.23** Concentration and contamination of alkali detergent when applying 30% draining ratio and draining pattern 2 cycles/time after 1 week pass.



**Figure 5.24** Concentration and contamination of alkali detergent when applying 40% draining ratio and draining pattern 2 cycles/time after 1 week pass.



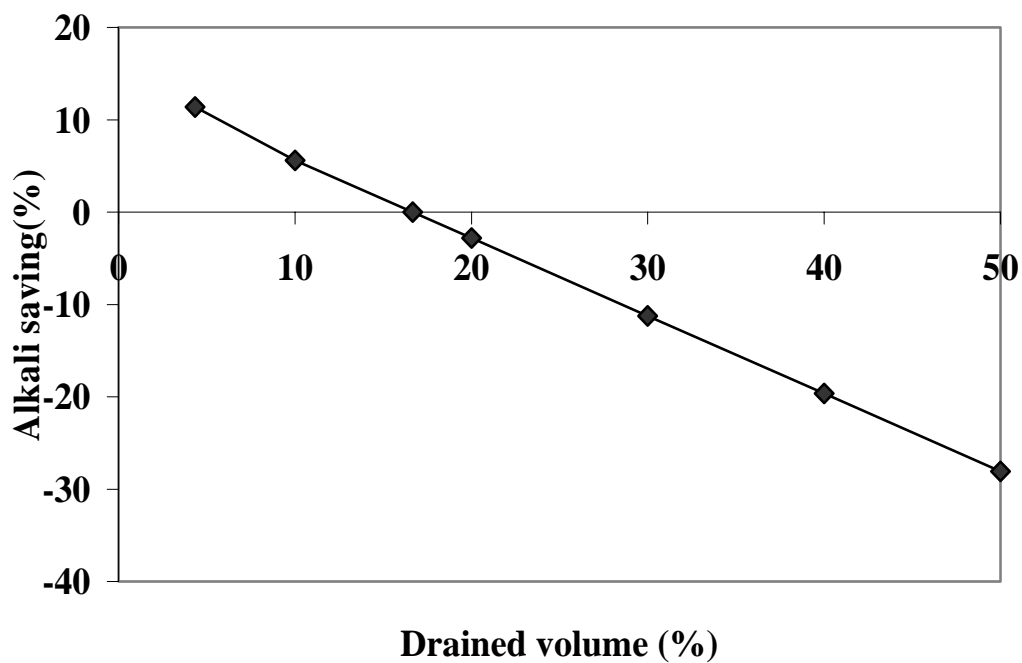


**Figure 5.25** Concentration and contamination of alkali detergent when applying 50% draining ratio and draining pattern 2 cycles/time after 1 week pass

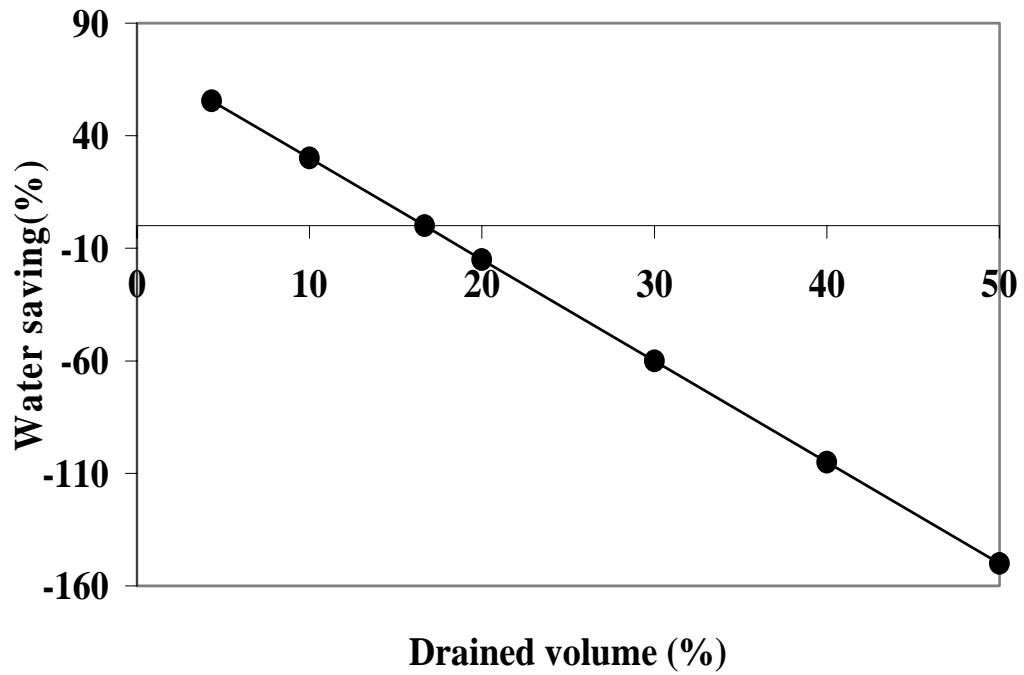
Since the draining ratios applied in figure 5.20-5.25 are more than the optimal draining ratio, the average contaminations after 1 week pass decrease from the ordinary value to lower values whereas there is no effect for the concentration case. Because of the chemical adding after every draining, the chemical concentration profiles do not change no matter how much the values of the draining ratios are. The summary and comparison of the consumptions among the various applied draining ratios are shown in the table 5.10

**Table 5.10** Summary and comparison of consumptions among the various applied draining ratios of CIP alkali cleaning step.

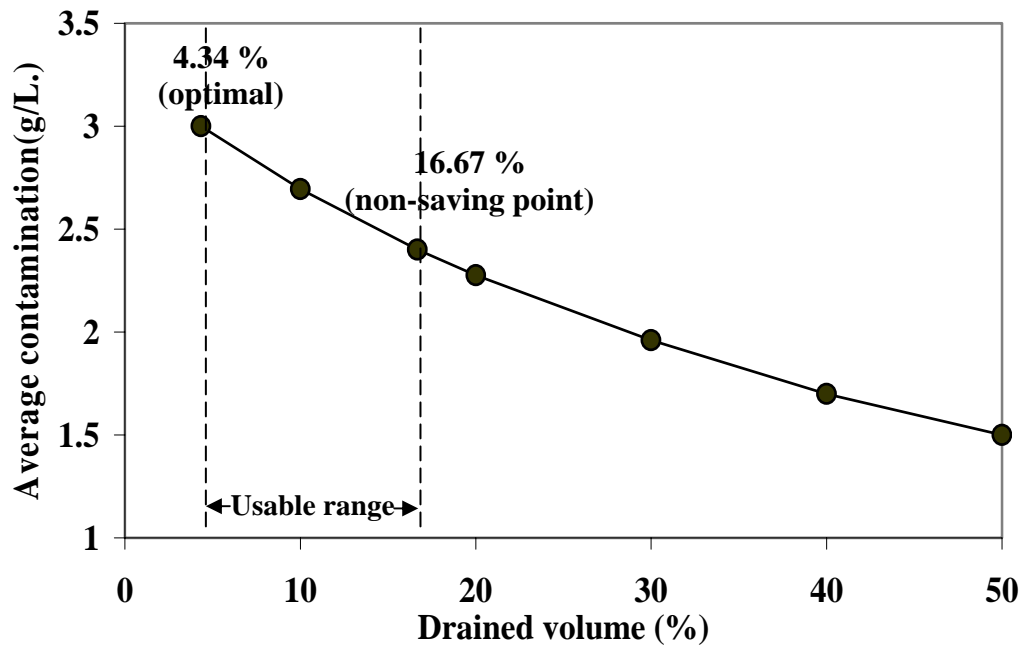
<b>D (%)</b>	<b>Draining Volume (L.)</b>	<b>Alkali saving (%)</b>	<b>Water saving (%)</b>	<b>C<sub>min</sub> (%)</b>	<b>X<sub>max</sub> (g/L.)</b>	<b>X<sub>average</sub> After a week (g/L.)</b>
<b>4.34</b>	21.70	10.39	55.49	0.98	3.03	3.00
<b>10</b>	50	5.62	30.00	0.98	3.03	2.70
<b>16.67</b>	83.35	0.00	0.00	0.98	3.03	2.40
<b>20</b>	100	-2.81	-15.00	0.98	3.03	2.28
<b>30</b>	150	-11.23	-60.00	0.98	3.03	1.96
<b>40</b>	200	-19.66	-105.00	0.98	3.03	1.70
<b>50</b>	250	-28.09	-150.00	0.98	3.03	1.50



(a)



(b)



(c)

**Figure 5.26** Alkali saving (a), water saving (b) and average alkali contaminations after 1 week (c) at the various draining ratios with the draining pattern 2 cycles/time after 1 week pass.

According to the table 5.10, the alkaline and water saving can be shown in figure 5.26. The operation result shows that the chemical and water saving have the greatest value at 4.34% draining ratio and reversely vary with the draining ratio. Moreover, the chemical and water saving are 0%, chemical and water consumptions equal to the plant actual consumptions, when the draining ratio is 16.67%. Beside, the average alkali contamination after 1 week pass is shown in figure 5.26(c). The average chemical contamination is curved-reversely varies with the draining ratios. From figure 5.26, we can summarize that the draining ratio with same draining pattern as the optimal draining ratio can be varied in the range of 4.34%-16.67%. Applying the draining ratio which is less than 4.34% makes the contamination is over the cleaning standard whereas applying the draining ratio which is more than 16.67% make more chemical and water consumptions than the actual consumptions.

#### **5.2.1.2 Study of initial concentration and contamination changes**

Because the chemical concentration and the contamination may be vary in each period, the optimal draining ratios in the different operating conditions have been obtained to cover the cleaning operation in the different conditions.

In this section, we have studied effects of the concentration changes in 80-120% of the ordinary value of concentration which cover the recommended usable range, 1.50%-2.00% (g/mL.) and the contamination changes in 70-130% of the ordinary value of contamination in details.

**Table 5.11** Optimal draining ratio (%) in the conditions of different initial concentrations and contaminations.

<b>X</b> (% of ordinary value)	<b>C (% of ordinary value)</b>								
	<b>-20</b>	<b>-15</b>	<b>-10</b>	<b>-5</b>	<b>0</b>	<b>5</b>	<b>10</b>	<b>15</b>	<b>20</b>
<b>-30</b>	4.34	4.34	4.34	4.34	4.34	11.03	11.03	11.03	11.03
<b>-25</b>	4.34	4.34	4.34	4.34	4.34	11.03	11.03	11.03	11.03
<b>-20</b>	4.34	4.34	4.34	4.34	4.34	11.03	11.03	11.03	11.03
<b>-15</b>	4.34	4.34	4.34	4.34	4.34	11.03	11.03	11.03	11.03
<b>-10</b>	4.34	4.34	4.34	4.34	4.34	11.03	11.03	11.03	11.03
<b>-5</b>	4.34	4.34	4.34	4.34	4.34	11.03	11.03	11.03	11.03
<b>0</b>	4.34	4.34	4.34	4.34	4.34	11.03	11.03	11.03	11.03
<b>5</b>	4.34	4.34	4.34	4.34	4.34	11.03	11.03	11.03	11.03
<b>10</b>	4.34	4.34	4.34	4.34	4.34	11.03	11.03	11.03	11.03
<b>15</b>	4.34	4.34	4.34	4.34	4.34	11.03	11.03	11.03	11.03
<b>20</b>	4.34	4.34	4.34	4.34	4.34	11.03	11.03	11.03	11.03
<b>25</b>	4.34	4.34	4.34	4.34	4.34	11.03	11.03	11.03	11.03
<b>30</b>	4.34	4.34	4.34	4.34	4.34	11.03	11.03	11.03	11.03

**Table 5.12** Minimum concentration (%g/mL.) in the conditions of different initial concentrations and contaminations.

<b>X</b> (% of ordinary value)	<b>C (% of ordinary value)</b>								
	<b>-20</b>	<b>-15</b>	<b>-10</b>	<b>-5</b>	<b>0</b>	<b>5</b>	<b>10</b>	<b>15</b>	<b>20</b>
<b>-30</b>	0.78	0.83	0.88	0.93	0.98	0.6	0.63	0.65	0.68
<b>-25</b>	0.78	0.83	0.88	0.93	0.98	0.6	0.63	0.65	0.68
<b>-20</b>	0.78	0.83	0.88	0.93	0.98	0.6	0.63	0.65	0.68
<b>-15</b>	0.78	0.83	0.88	0.93	0.98	0.6	0.63	0.65	0.68
<b>-10</b>	0.78	0.83	0.88	0.93	0.98	0.6	0.63	0.65	0.68
<b>-5</b>	0.78	0.83	0.88	0.93	0.98	0.6	0.63	0.65	0.68
<b>0</b>	0.78	0.83	0.88	0.93	0.98	0.6	0.63	0.65	0.68
<b>5</b>	0.78	0.83	0.88	0.93	0.98	0.6	0.63	0.65	0.68
<b>10</b>	0.78	0.83	0.88	0.93	0.98	0.6	0.63	0.65	0.68
<b>15</b>	0.78	0.83	0.88	0.93	0.98	0.6	0.63	0.65	0.68
<b>20</b>	0.78	0.83	0.88	0.93	0.98	0.6	0.63	0.65	0.68
<b>25</b>	0.78	0.83	0.88	0.93	0.98	0.6	0.63	0.65	0.68
<b>30</b>	0.78	0.83	0.88	0.93	0.98	0.6	0.63	0.65	0.68



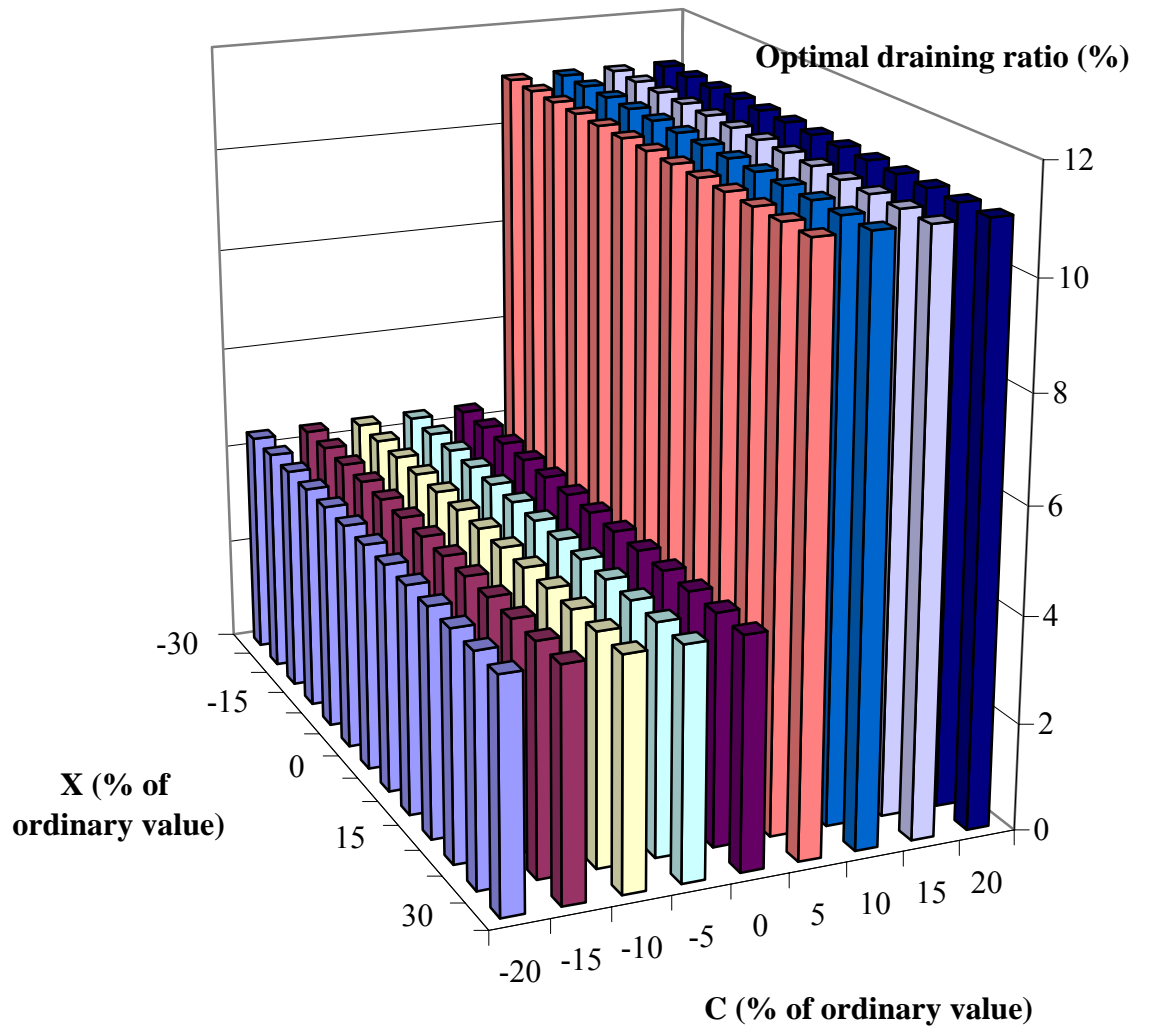
**Table 5.14** Chemical saving (%) in the conditions of different initial concentrations and contaminations.

<b>X</b> (% of ordinary value)	<b>C (% of ordinary value)</b>								
	<b>-20</b>	<b>-15</b>	<b>-10</b>	<b>-5</b>	<b>0</b>	<b>5</b>	<b>10</b>	<b>15</b>	<b>20</b>
<b>-30</b>	10.39	10.39	10.39	10.39	10.39	7.26	7.26	7.26	7.26
<b>-25</b>	10.39	10.39	10.39	10.39	10.39	7.26	7.26	7.26	7.26
<b>-20</b>	10.39	10.39	10.39	10.39	10.39	7.26	7.26	7.26	7.26
<b>-15</b>	10.39	10.39	10.39	10.39	10.39	7.26	7.26	7.26	7.26
<b>-10</b>	10.39	10.39	10.39	10.39	10.39	7.26	7.26	7.26	7.26
<b>-5</b>	10.39	10.39	10.39	10.39	10.39	7.26	7.26	7.26	7.26
<b>0</b>	10.39	10.39	10.39	10.39	10.39	7.26	7.26	7.26	7.26
<b>5</b>	10.39	10.39	10.39	10.39	10.39	7.26	7.26	7.26	7.26
<b>10</b>	10.39	10.39	10.39	10.39	10.39	7.26	7.26	7.26	7.26
<b>15</b>	10.39	10.39	10.39	10.39	10.39	7.26	7.26	7.26	7.26
<b>20</b>	10.39	10.39	10.39	10.39	10.39	7.26	7.26	7.26	7.26
<b>25</b>	10.39	10.39	10.39	10.39	10.39	7.26	7.26	7.26	7.26
<b>30</b>	10.39	10.39	10.39	10.39	10.39	7.26	7.26	7.26	7.26

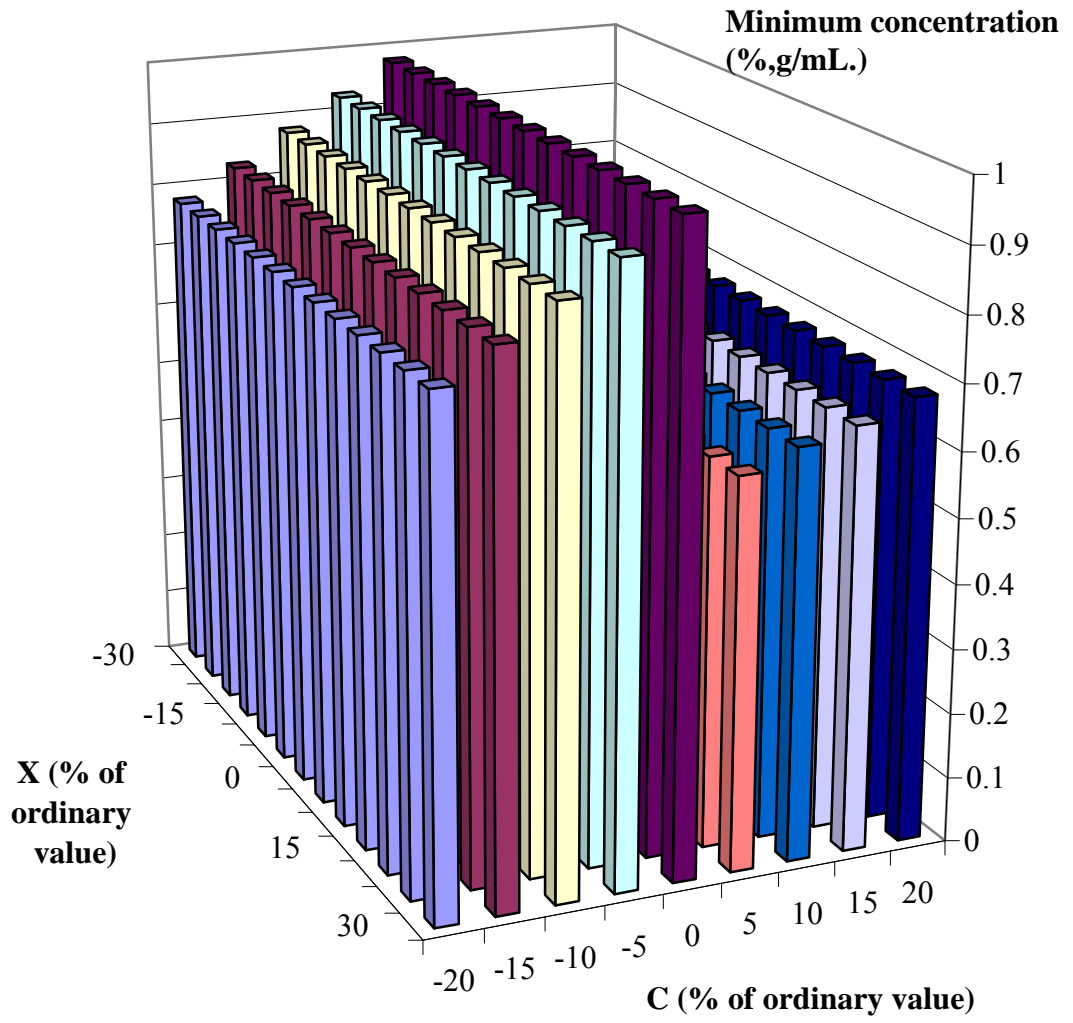


**Table 5.15** Water saving (%) in the conditions of different initial concentrations and contaminations.

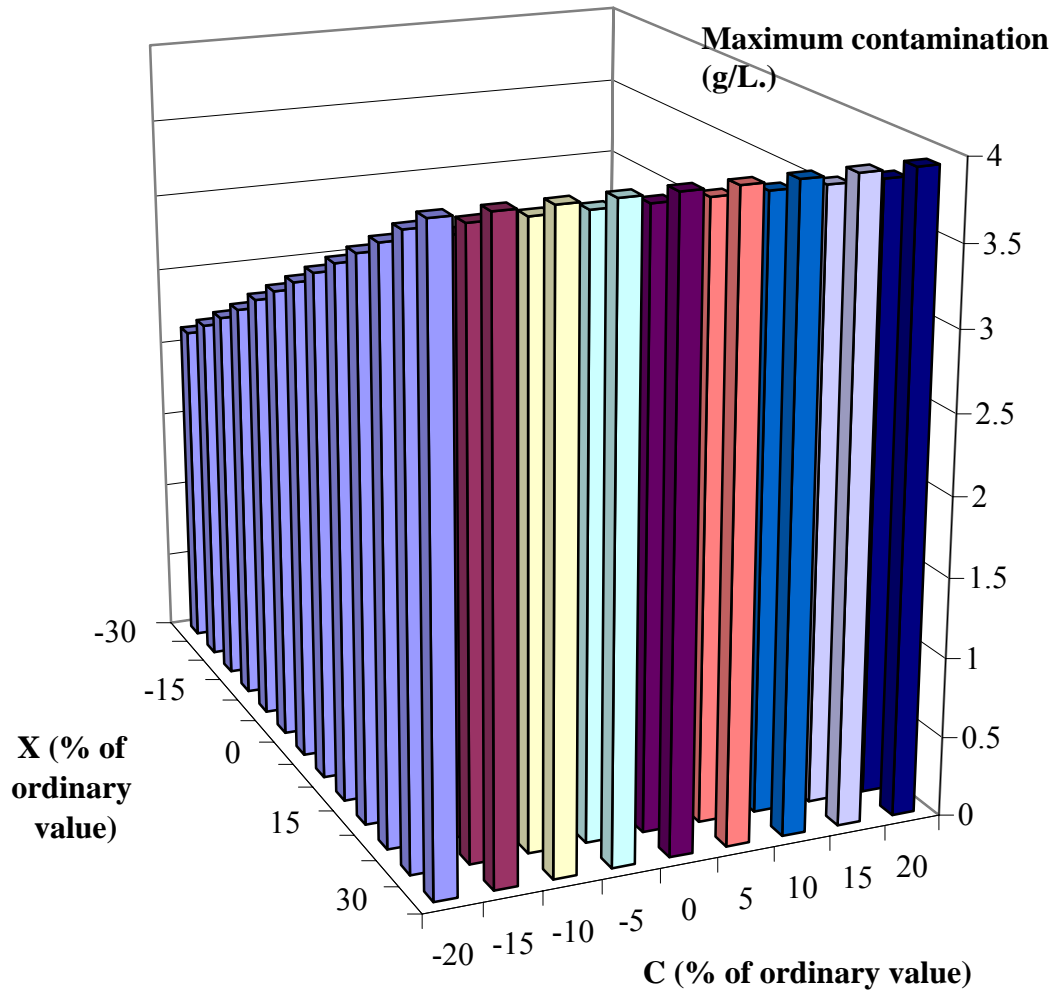
<b>X</b> (% of ordinary value)	<b>C (% of ordinary value)</b>								
	<b>-20</b>	<b>-15</b>	<b>-10</b>	<b>-5</b>	<b>0</b>	<b>5</b>	<b>10</b>	<b>15</b>	<b>20</b>
<b>-30</b>	55.49	55.49	55.49	55.49	55.49	50.18	50.18	50.18	50.18
<b>-25</b>	55.49	55.49	55.49	55.49	55.49	50.18	50.18	50.18	50.18
<b>-20</b>	55.49	55.49	55.49	55.49	55.49	50.18	50.18	50.18	50.18
<b>-15</b>	55.49	55.49	55.49	55.49	55.49	50.18	50.18	50.18	50.18
<b>-10</b>	55.49	55.49	55.49	55.49	55.49	50.18	50.18	50.18	50.18
<b>-5</b>	55.49	55.49	55.49	55.49	55.49	50.18	50.18	50.18	50.18
<b>0</b>	55.49	55.49	55.49	55.49	55.49	50.18	50.18	50.18	50.18
<b>5</b>	55.49	55.49	55.49	55.49	55.49	50.18	50.18	50.18	50.18
<b>10</b>	55.49	55.49	55.49	55.49	55.49	50.18	50.18	50.18	50.18
<b>15</b>	55.49	55.49	55.49	55.49	55.49	50.18	50.18	50.18	50.18
<b>20</b>	55.49	55.49	55.49	55.49	55.49	50.18	50.18	50.18	50.18
<b>25</b>	55.49	55.49	55.49	55.49	55.49	50.18	50.18	50.18	50.18
<b>30</b>	55.49	55.49	55.49	55.49	55.49	50.18	50.18	50.18	50.18



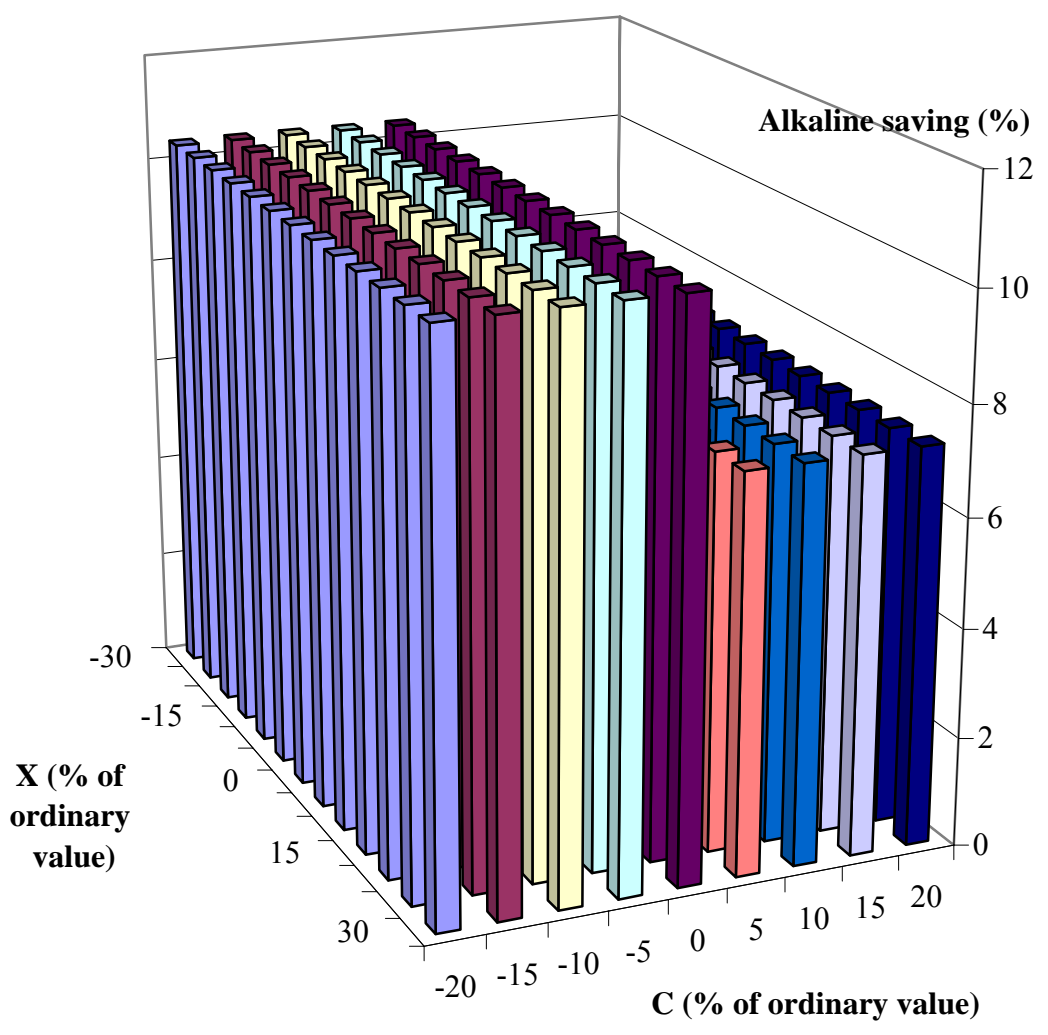
(a)



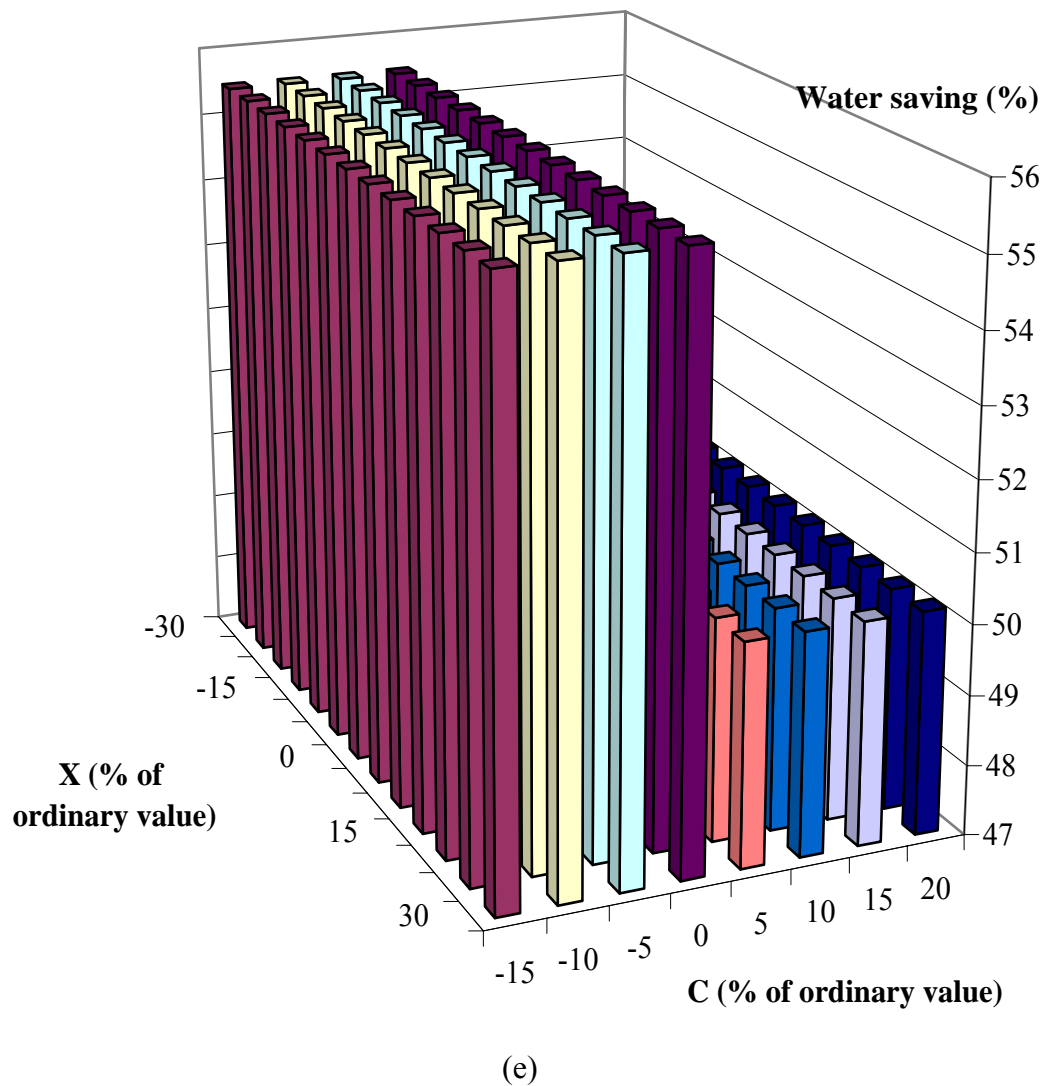
(b)



(c)



(d)



**Figure 5.27** Optimal draining ratios (%) (a), minimum concentrations (%g/mL.) (b), maximum contaminations (g/L.) (c), alkaline saving (%) (d) and water saving (%) (e) in the conditions of different initial concentrations and contaminations.

The chemical concentration and contamination have been varied in the range of 80%-120% of the ordinary concentration value and 70%-130% of the ordinary contamination value. The results show that the obtained optimal draining ratios in this variation are 4.34% in 80%-100%, 1.35%-1.69% (g/mL.), and 11.03% in 105%-130% of concentration ranges, 1.77%-2.03% (g/mL.), which have the draining patterns 2 and 4 cycles/time after 1 week pass respectively. In addition, the minimum chemical concentration has an increasing trend continuously in 80%-100% of the ordinary concentration value because the initial chemical concentrations are higher

values. In 105%-120% of the ordinary concentration value, the minimum chemical concentration are adjusted to the small values than the previous range because there is a change of the optimal draining ratio and the draining pattern from 4.34% to 11.03 % and 2 cycles/time to 4 cycles/time after 1 week pass. The longer used cycle affects the minimum concentration directly. However, the trend in this range of the chemical concentration is also continuously increasing trend. Beside, the chemical contamination has an increasing trend when the initial contamination in the residual water is higher. From figure 5.27(d)-5.27(e), the results show that the chemical and water saving are respect to the optimal draining ratio. In the range of the obtained optimal draining ratios as 4.34%, the chemical and water saving is 10.39% and 55.49%. And, in the range of the obtained optimal draining ratios as 11.03%, the chemical and water saving is 7.27% and 50.18%. Because of the higher drained chemical volume, the chemical and water saving decrease to smaller values.

### 5.2.2 Case II acid cleaning optimization problem

From optimization problem in the section 4.4, we have applied constraints and express the problem in this case as following.

$$\text{Min}_D \sum_{j=1}^n A(j) \quad (5.19)$$

Where

$$A(j) = V_c(j)(C_{\text{target}} - (1-D)C_{\text{cf}}(j-1)) \quad (5.20)$$

$$W = \sum_{j=1}^n w(j) = \sum_{j=1}^n (D(j)V_c(j)) \quad (5.21)$$

Subject to

$$\frac{dV_c}{dt} = F_{\text{ic}} - F_{\text{oc}} \quad (5.22)$$

$$\frac{dC_c}{dt} = \frac{F_{\text{ic}}(1-\beta)}{V} (C_{\text{ic}} - C_{\text{oc}}) \quad (5.23)$$

$$\frac{dX_c}{dt} = \frac{F_{ic}(1-(\beta+\mu))}{V}(X_{ic} - X_{oc}) \quad (5.24)$$

$$\frac{dV_e}{dt} = F_{oe} - F_{ie} \quad (5.25)$$

$$\frac{dC_e}{dt} = \frac{F_{ie}}{V_e}(C_{oe} - C_{ie}) \quad (5.26)$$

$$\frac{dX_e}{dt} = \frac{F_{ie}}{V_e}(X_{oe} - X_{ie}) \quad (5.27)$$

$$C_{ie} = C_{oc} = \beta C_{ic} + (1-\beta) C_c \quad (5.28)$$

$$X_{ie} = X_{oc} = (\beta+\mu) X_{ic} + (1-(\beta+\mu)) X_c \quad (5.29)$$

$$C_{ic} = C_{oe} \quad (5.30)$$

$$X_{ic} = X_{oe} \quad (5.31)$$

$$C_{ci}(j+1) = \begin{cases} C_{cf}(j) & \text{if } \text{rem}(j,n) \neq 0 \text{ and } C_{cf}(j) > 1 \\ C_{target} & \text{if } \text{rem}(j,n) \neq 0 \text{ and } C_{cf}(j) < 1 \\ C_{target} & \text{if } \text{rem}(j,n) = 0 \end{cases} \quad (5.32)$$

$$X_{ci}(j+1) = \begin{cases} X_{cf}(j) & \text{if } \text{rem}(j,n) \neq 0 \\ 0 & \text{if } \text{rem}(j,n) = 0 \end{cases} \quad (5.33)$$

$$C_c \leq C_{min} \quad (5.34)$$

$$X_c \leq X_{max} \quad (5.35)$$

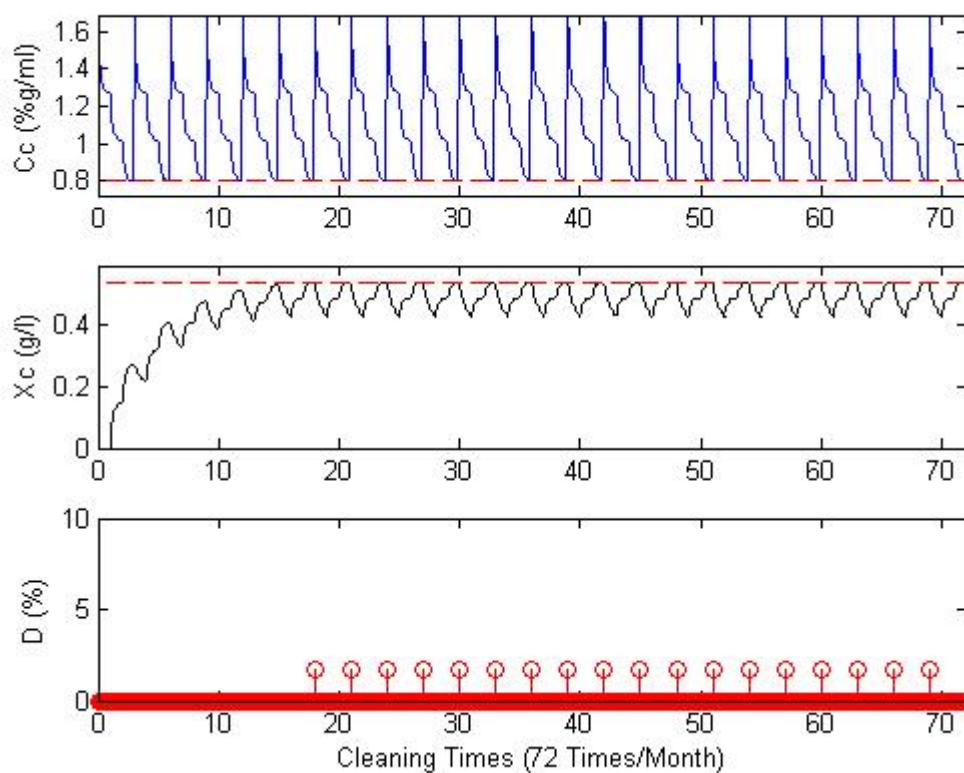
$$0 \leq D \leq 1 \quad (5.36)$$

Similarly, the minimum concentration and the maximum contamination in optimization for the acid problem have been defined from the same values as the cleaning simulation of the plant. Thus, 0.80% and 0.54g/l. have been used in this optimization solving.

The draining ratios and draining patterns are adjusted to match with the dynamic behaviors of the properties, concentration and contamination, of the acid



detergent which is used in the acid cleaning step under process constraints in the optimization. The optimization determines the optimal draining ratio that makes the least acid discharging whereas the acid cleaning process still can maintain the quality completely. The result shows that the optimal draining ratio and the draining pattern for this case, acid cleaning step, is obtained as 1.70% of alkaline volume drained after the 18<sup>th</sup>, 21<sup>th</sup>, 24<sup>th</sup> ... 66<sup>th</sup> and 69<sup>th</sup> cleaning cycles or 3 cycles/time after 1 week pass. The concentration and contamination of acid detergent when applying the offered method with the optimal draining ratio during cleaning operation can be illustrated consecutively in following figures.



**Figure 5.28** Concentration and contamination of acid detergent when applying the offered method with 1.70% draining ratio.

The operation result of the offered and the plant actual method in this case have been summarized and compared as shown in the table 5.16

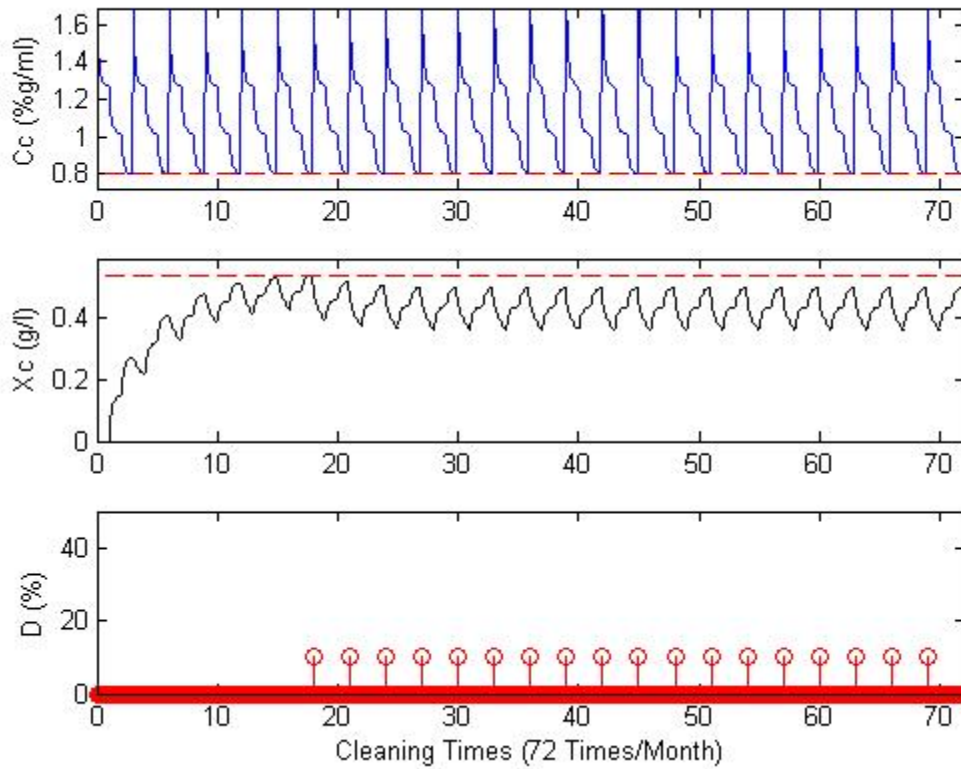
**Table 5.16** Summary and comparison of consumptions between the plant actual method and the offered method with the optimal draining ratio of CIP acid cleaning step

<b>D (%)</b>	<b>Draining Volume (L.)</b>	<b>Draining time (after cycle)</b>	<b>Duration from last draining</b>	<b>Acid saving (%)</b>	<b>Water saving (%)</b>	<b>C<sub>min</sub> (%)</b>	<b>X<sub>max</sub> (g/L.)</b>
<b>1.70</b>	8.50	18,21,24,...,69	3	8.82	67.36	0.80	0.54
<b>100 (actual)</b>	500	18,36,54	18	-	-	0.80	0.54

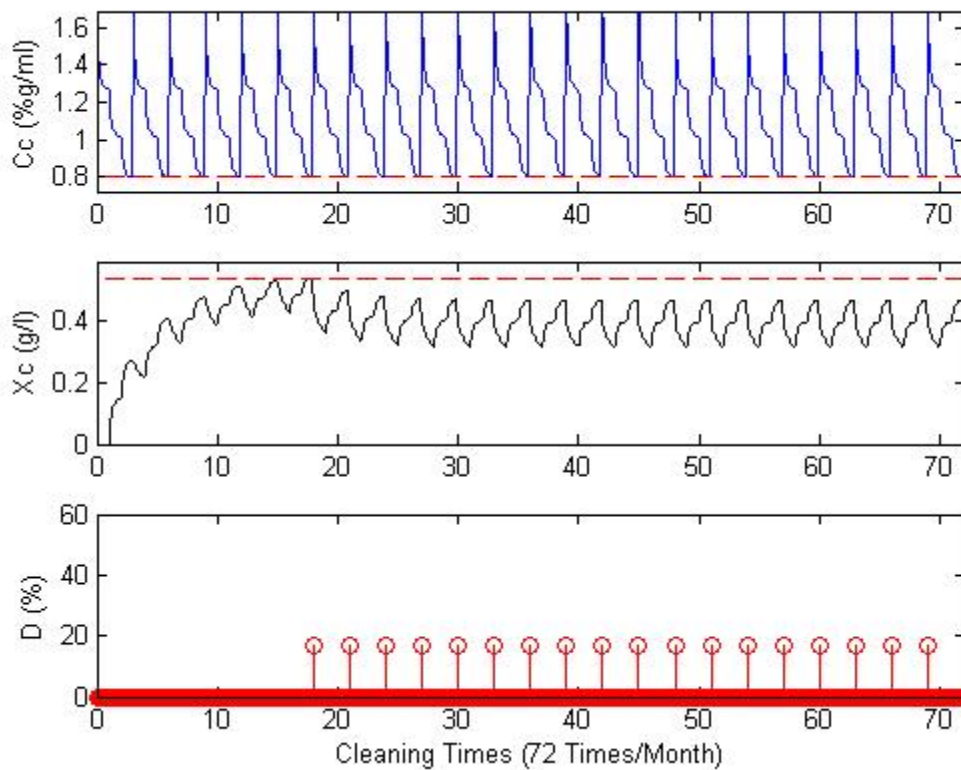
According to table 5.16, we have found that 1.70% of draining ratio, 8.50 liter which generates the draining pattern as draining after the 18<sup>th</sup>, 21<sup>th</sup>, 24<sup>th</sup> ... 66<sup>th</sup> and 69<sup>th</sup> cleaning cycle, 3 cycle/time after 1 week pass, is the optimal solution. In addition, the offered method with the optimal draining ratio can save the chemical and the water used in acid cleaning step as 8.82% and 67.36% of the plant actual consumptions.

### 5.2.2.1 Study of the draining ratio value changes

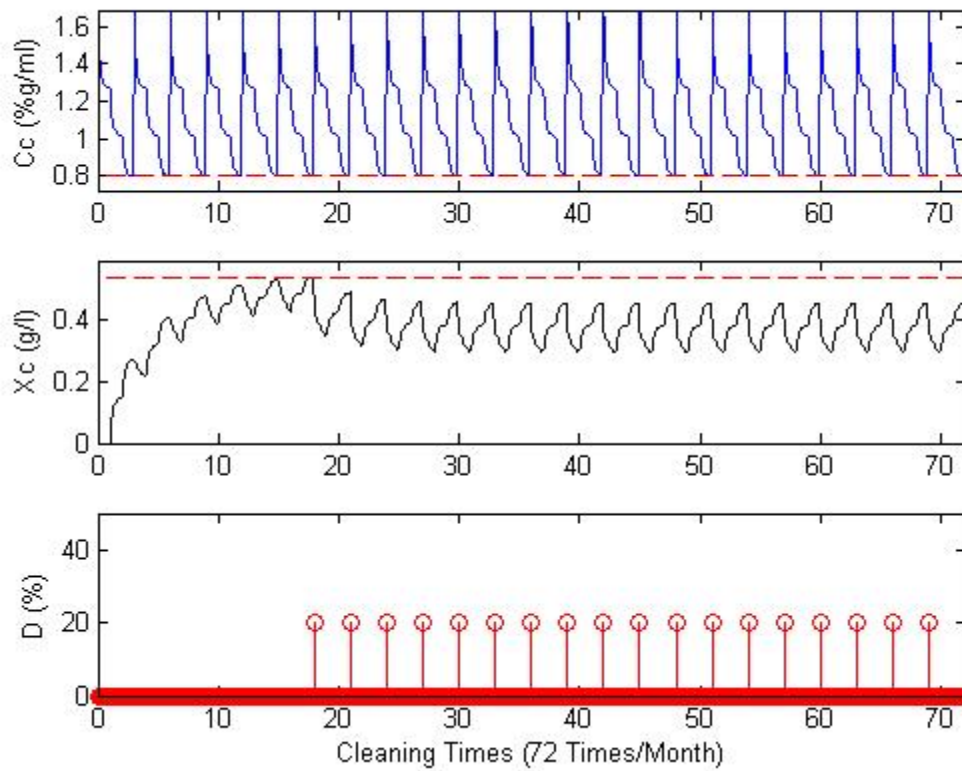
To be alternatives for the real cleaning operations, the effects of variations of the draining ratio have been studied. The concentration and contamination of acid detergent in the cleaning operation which applied vary draining ratios in the range of 10%-50% with the same draining pattern of the obtained optimal draining ratio have been shown in figure 5.29-5.34.



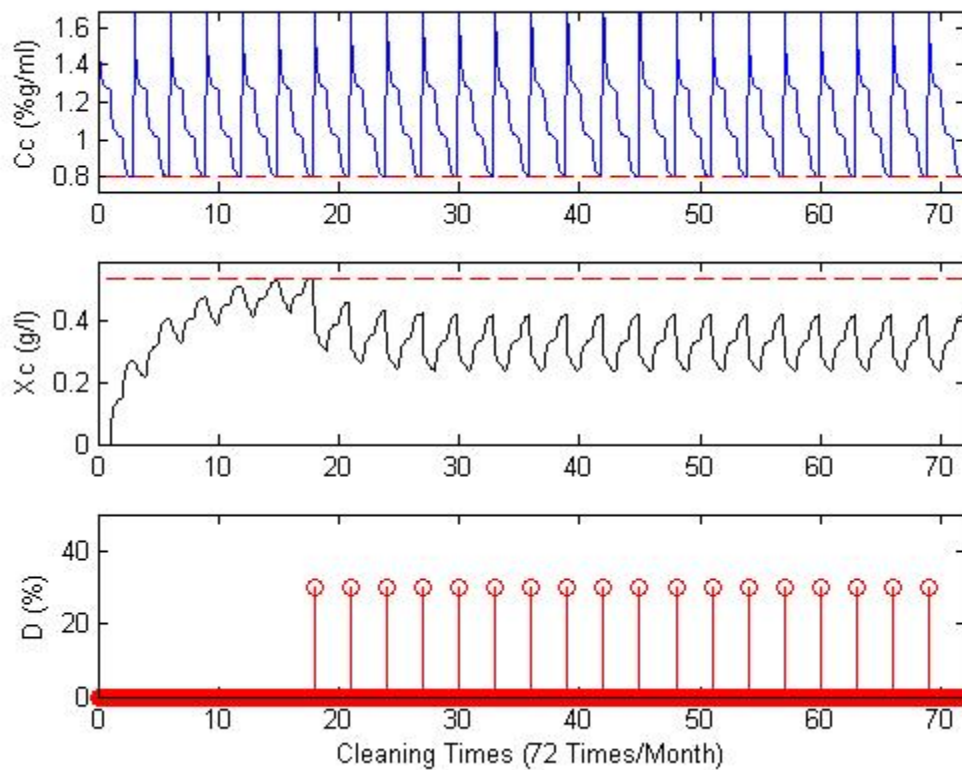
**Figure 5.29** Concentration and contamination of acid detergent when applying 10% draining ratio and draining pattern 3 cycles/time after 1 week pass.



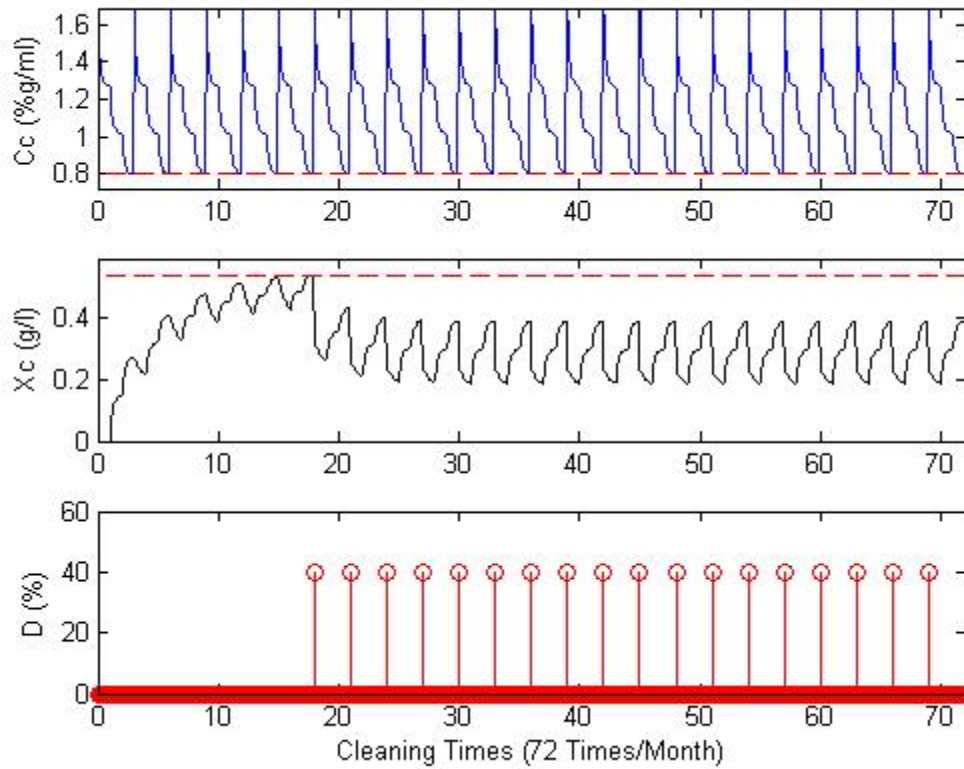
**Figure 5.30** Concentration and contamination of acid detergent when applying 16.67% draining ratio and draining pattern 3 cycles/time after 1 week pass.



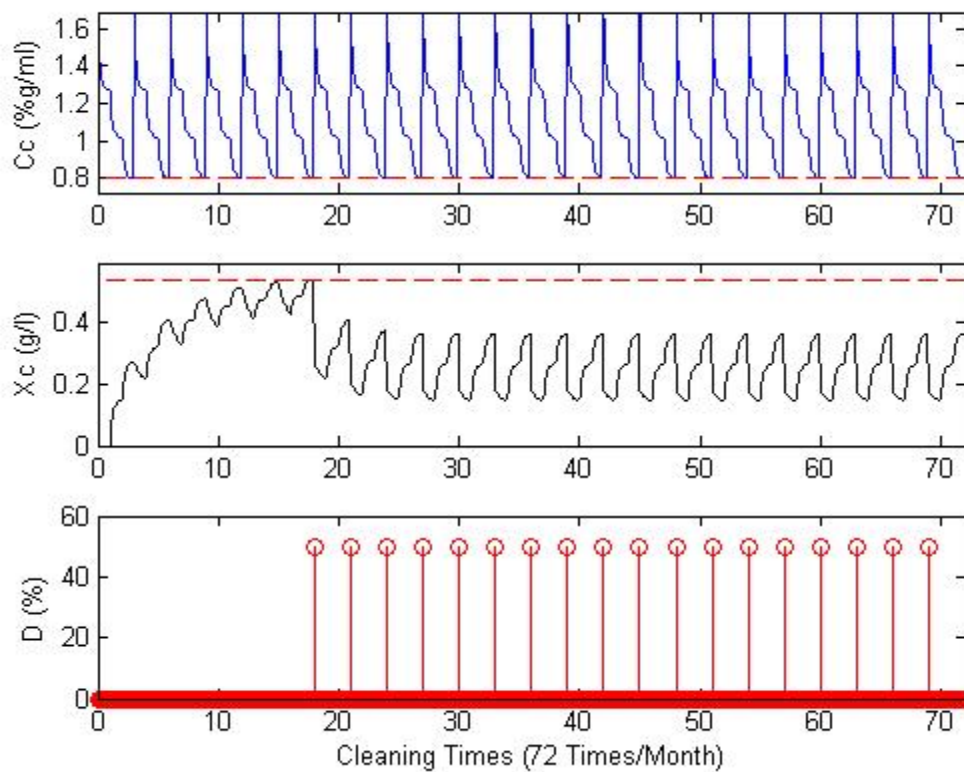
**Figure 5.31** Concentration and contamination of acid detergent when applying 20% draining ratio and draining pattern 3 cycles/time after 1 week pass.



**Figure 5.32** Concentration and contamination of acid detergent when applying 30% draining ratio and draining pattern 3 cycles/time after 1 week pass.



**Figure 5.33** Concentration and contamination of acid detergent when applying 40% draining ratio and draining pattern 3 cycles/time after 1 week pass.

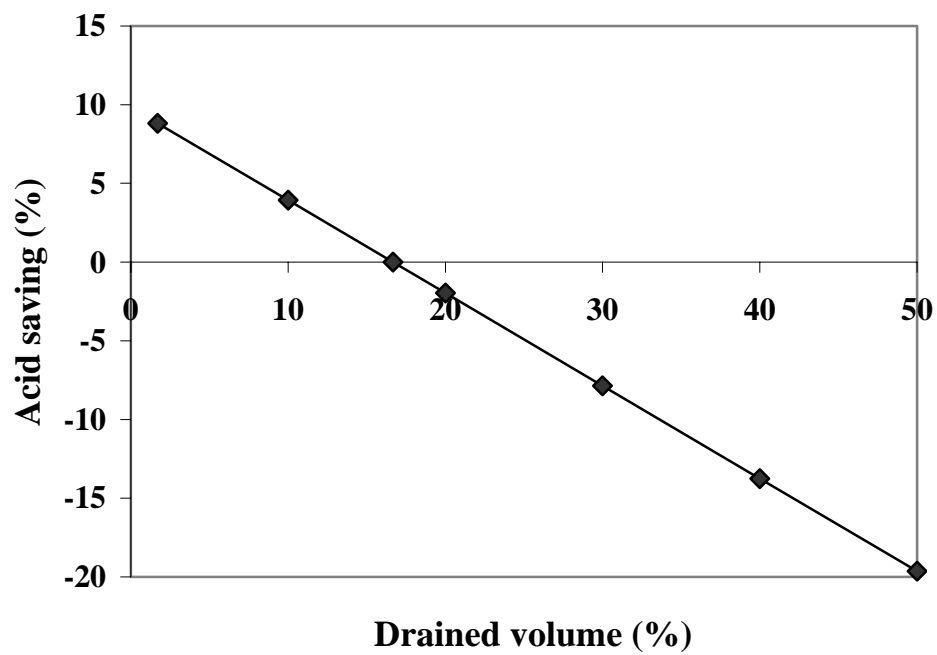


**Figure 5.34** Concentration and contamination of acid detergent when applying 50% draining ratio and draining pattern 3 cycles/time after 1 week pass.

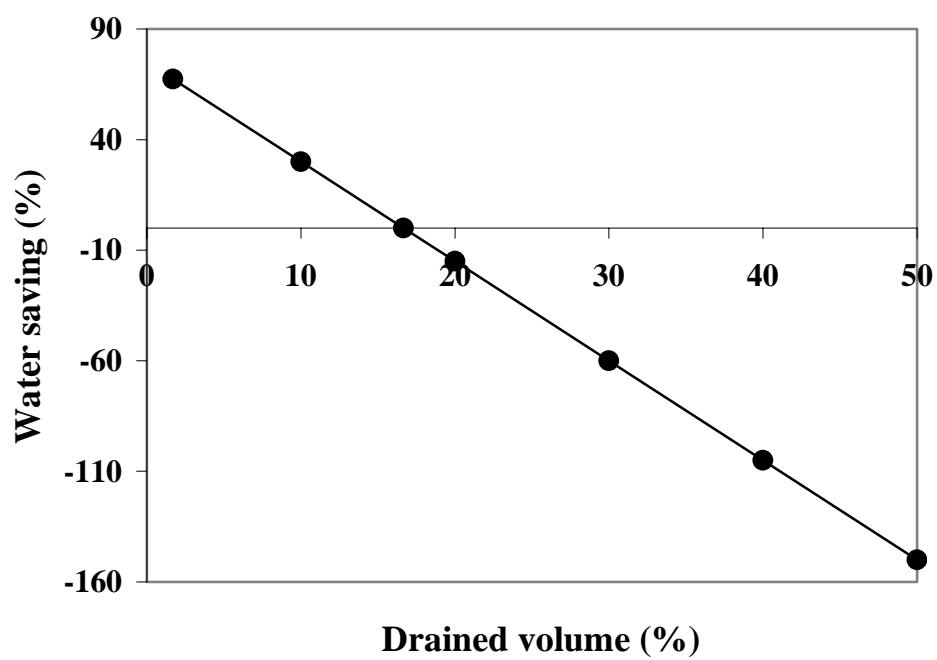
Since the draining ratios applied in figure 5.29-5.34 are more than the optimal draining ratio, the average contaminations after 1 week pass decrease from the ordinary value to lower values whereas there is no effect for the concentration case. Because of the chemical adding after every draining, the chemical concentration profiles do not change no matter how much the values of the draining ratios are. The summary and comparison of the consumptions among the various applied draining ratios are shown in the table 5.17

**Table 5.17** Summary and comparison of consumptions among the various applied draining ratios of CIP acid cleaning step.

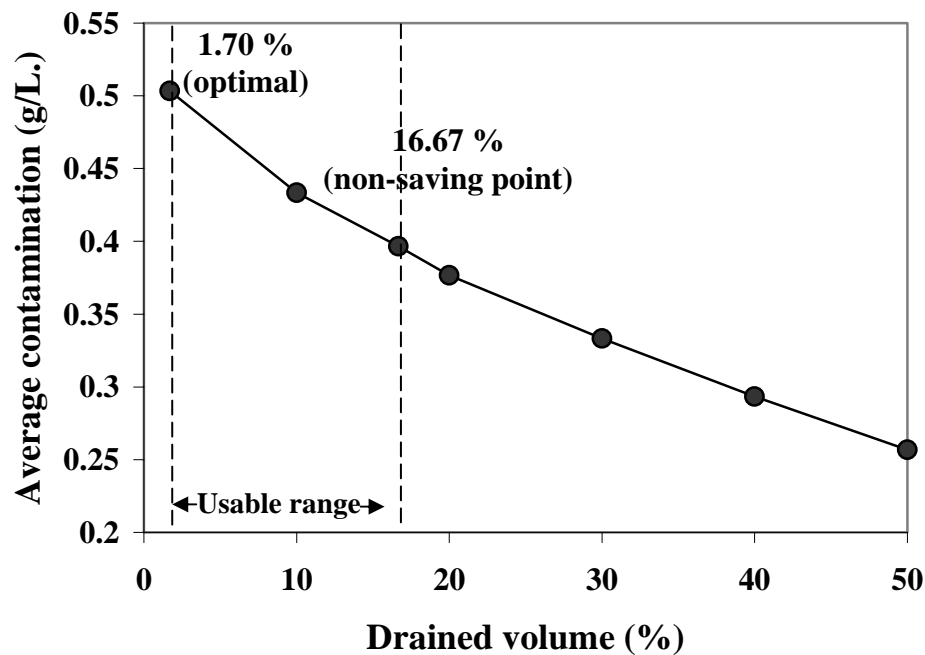
<b>D (%)</b>	<b>Draining Volume (L.)</b>	<b>Acid saving (%)</b>	<b>Water saving (%)</b>	<b>C<sub>min</sub> (%)</b>	<b>X<sub>max</sub> (g/L.)</b>	<b>X<sub>average</sub> After a week (g/L.)</b>
<b>1.70</b>	8.5	8.82	67.36	0.8	0.54	0.50
<b>10</b>	50	3.93	30.00	0.8	0.54	0.43
<b>16.67</b>	83.35	0.00	0.00	0.8	0.54	0.40
<b>20</b>	100	-1.96	-15.00	0.8	0.54	0.38
<b>30</b>	150	-7.86	-60.00	0.8	0.54	0.33
<b>40</b>	200	-13.75	-105.00	0.8	0.54	0.29
<b>50</b>	250	-19.64	-150.00	0.8	0.54	0.26



(a)



(b)



(c)

**Figure 5.35** Acid saving (a), water saving (b) and average acid contaminations after 1 week (c) at the various draining ratios with the draining pattern 2 cycles/time after 1 week pass.

From the summary in table 5.17, the acid and water saving can be shown in figure 5.35. The operation result shows that the chemical and water saving have the greatest value at 1.70% draining ratio and reversely vary with the draining ratio. Moreover, the chemical and water saving are 0%, chemical and water consumptions equal to the plant actual consumptions, when the draining ratio is 16.67%. Beside, the average contamination after 1 week pass is shown in figure 5.35(c). The average chemical contamination is curved-reversely varies with the draining ratios. From figure 5.35(a)-(b), we can summarize that the draining ratio with same draining pattern as the optimal draining ratio can be varied in the range of 1.70%-16.67%. Applying the draining ratio which is less than 1.70% also makes the contamination is over the cleaning standard whereas applying the draining ratio which is more than 16.67% make more chemical and water consumptions than the actual consumptions.



### **5.2.2.2 Study of initial concentration and contamination changes**

Because the chemical concentration and the contamination may be vary in each period, the optimal draining ratios in the different operating conditions have been obtained to cover the cleaning operation in the different conditions.

In this part, we have studied effects of the concentration changes in 80-120% of the ordinary value of concentration which cover the recommended usable range, 1.50%-2.00% (g/mL.) and the contamination changes in 70-130% of the ordinary value of contamination in details.



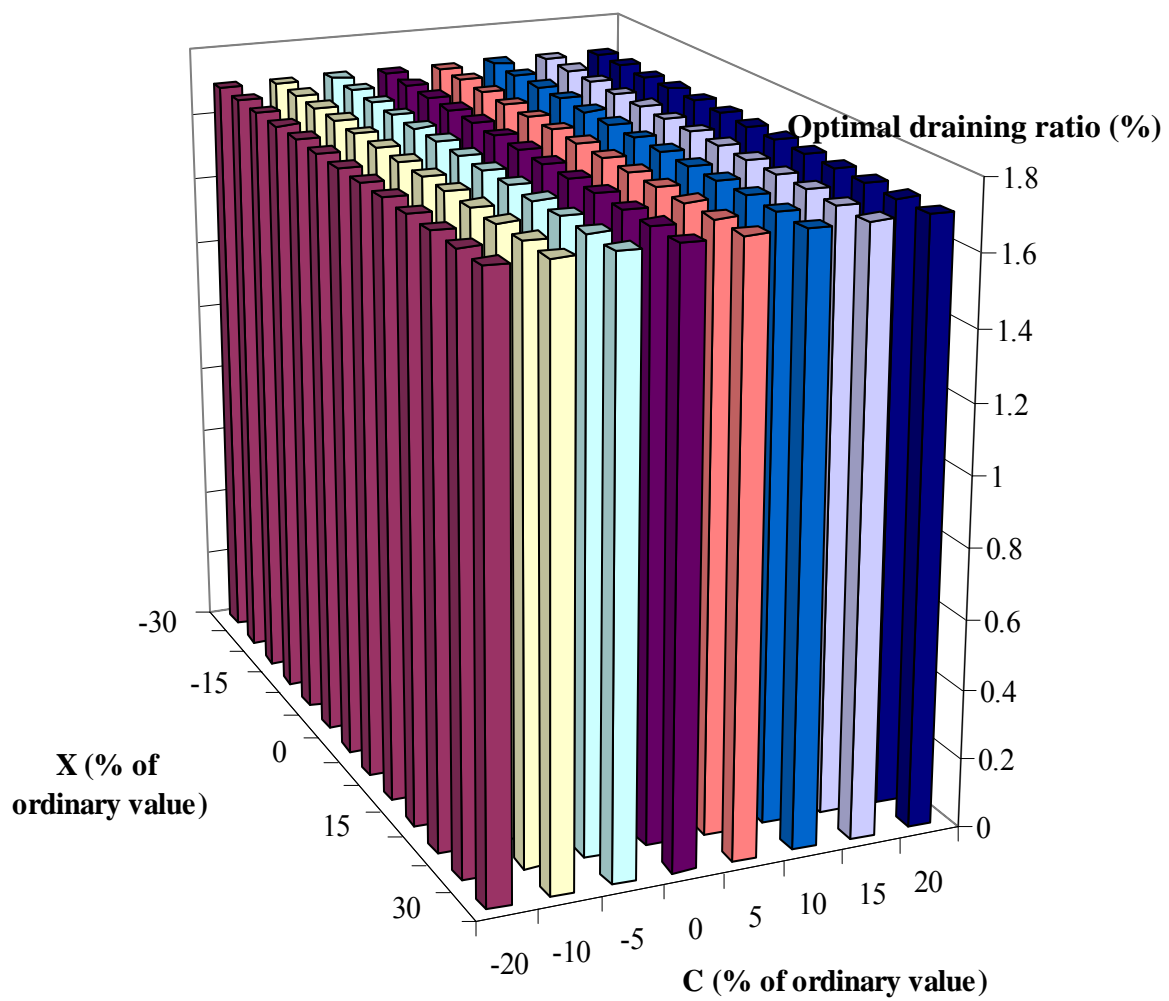
**Table 5.19** Minimum concentration (%g/mL.) in the conditions of different initial concentrations and contaminations.

<b>X</b> (% of ordinary value)	<b>C (% of ordinary value)</b>								
	<b>-20</b>	<b>-15</b>	<b>-10</b>	<b>-5</b>	<b>0</b>	<b>5</b>	<b>10</b>	<b>15</b>	<b>20</b>
<b>-30</b>	0.64	0.68	0.72	0.76	0.80	0.84	0.88	0.92	0.96
<b>-25</b>	0.64	0.68	0.72	0.76	0.80	0.84	0.88	0.92	0.96
<b>-20</b>	0.64	0.68	0.72	0.76	0.80	0.84	0.88	0.92	0.96
<b>-15</b>	0.64	0.68	0.72	0.76	0.80	0.84	0.88	0.92	0.96
<b>-10</b>	0.64	0.68	0.72	0.76	0.80	0.84	0.88	0.92	0.96
<b>-5</b>	0.64	0.68	0.72	0.76	0.80	0.84	0.88	0.92	0.96
<b>0</b>	0.64	0.68	0.72	0.76	0.80	0.84	0.88	0.92	0.96
<b>5</b>	0.64	0.68	0.72	0.76	0.80	0.84	0.88	0.92	0.96
<b>10</b>	0.64	0.68	0.72	0.76	0.80	0.84	0.88	0.92	0.96
<b>15</b>	0.64	0.68	0.72	0.76	0.80	0.84	0.88	0.92	0.96
<b>20</b>	0.64	0.68	0.72	0.76	0.80	0.84	0.88	0.92	0.96
<b>25</b>	0.64	0.68	0.72	0.76	0.80	0.84	0.88	0.92	0.96
<b>30</b>	0.64	0.68	0.72	0.76	0.80	0.84	0.88	0.92	0.96

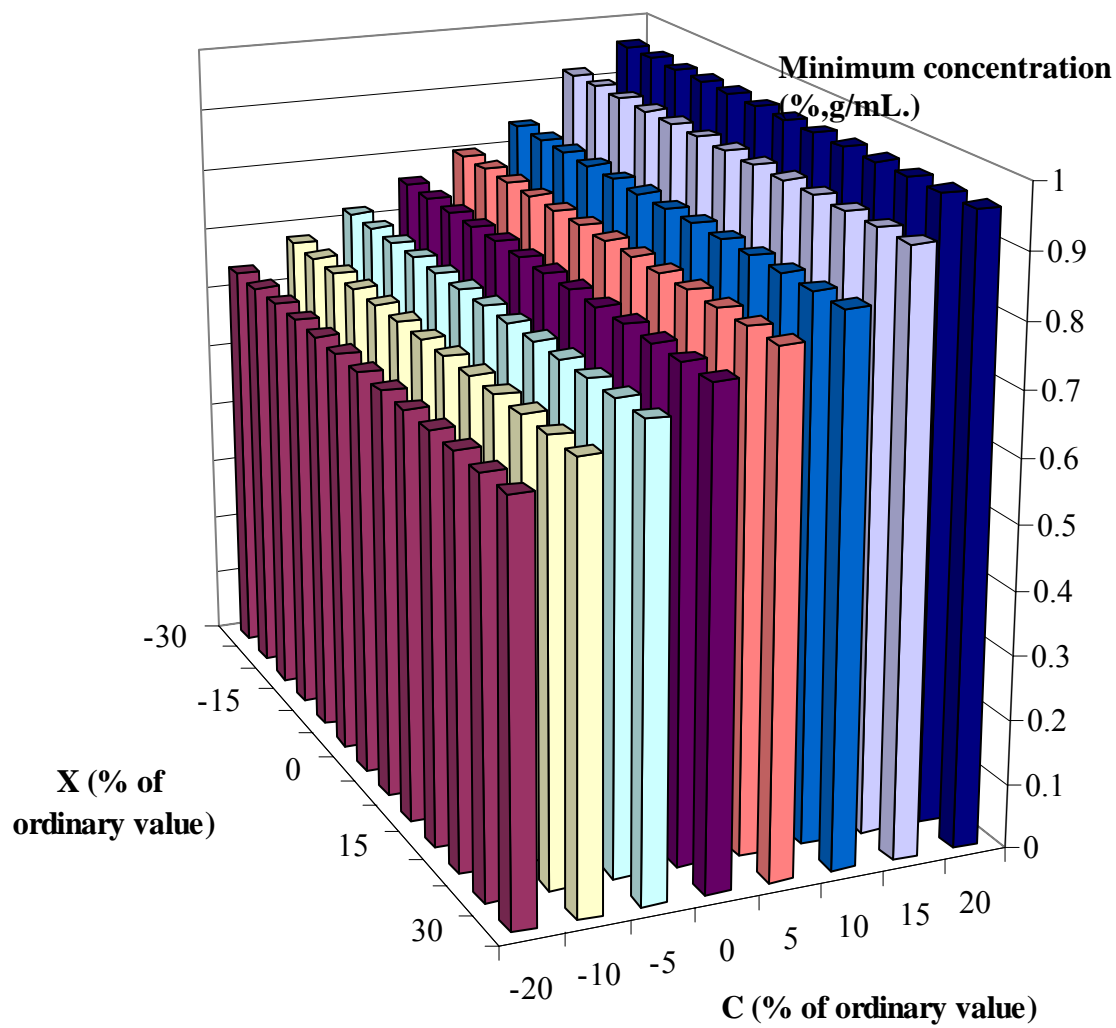






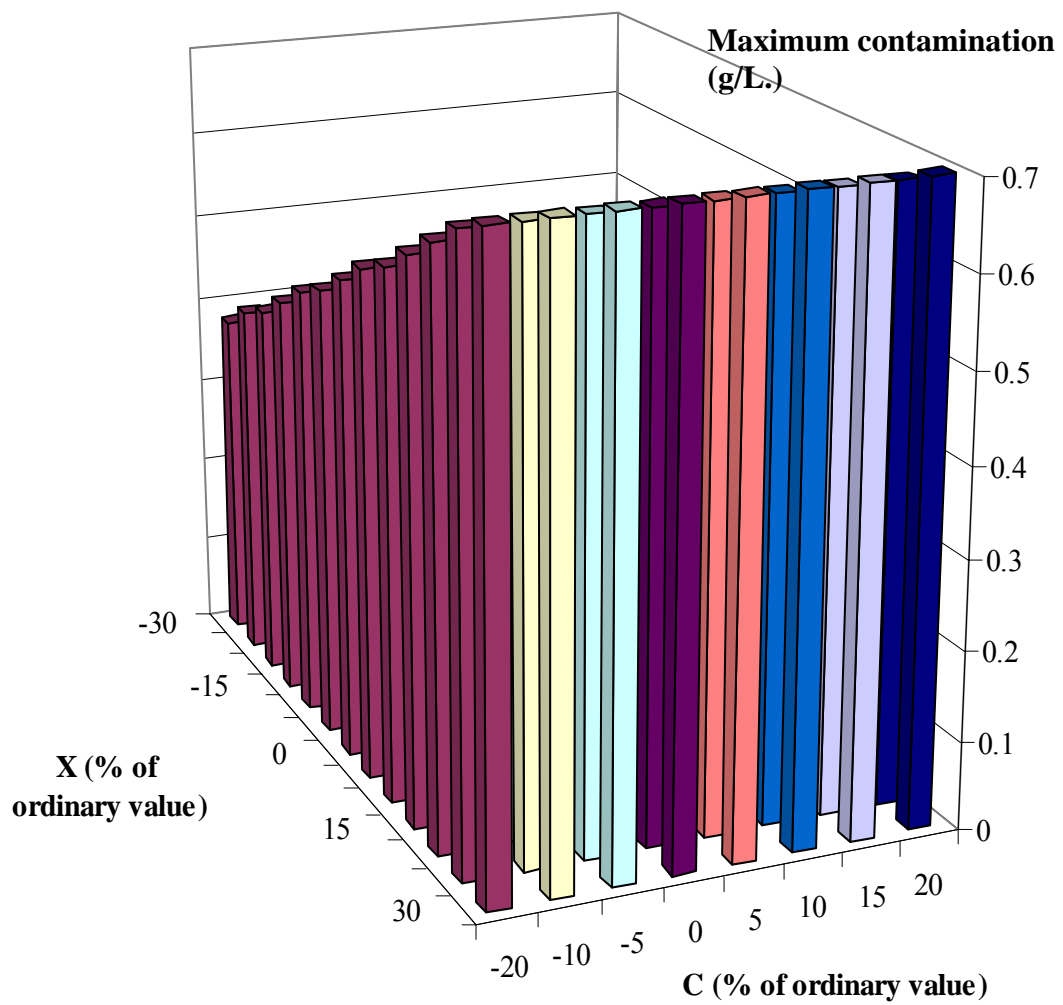


(a)

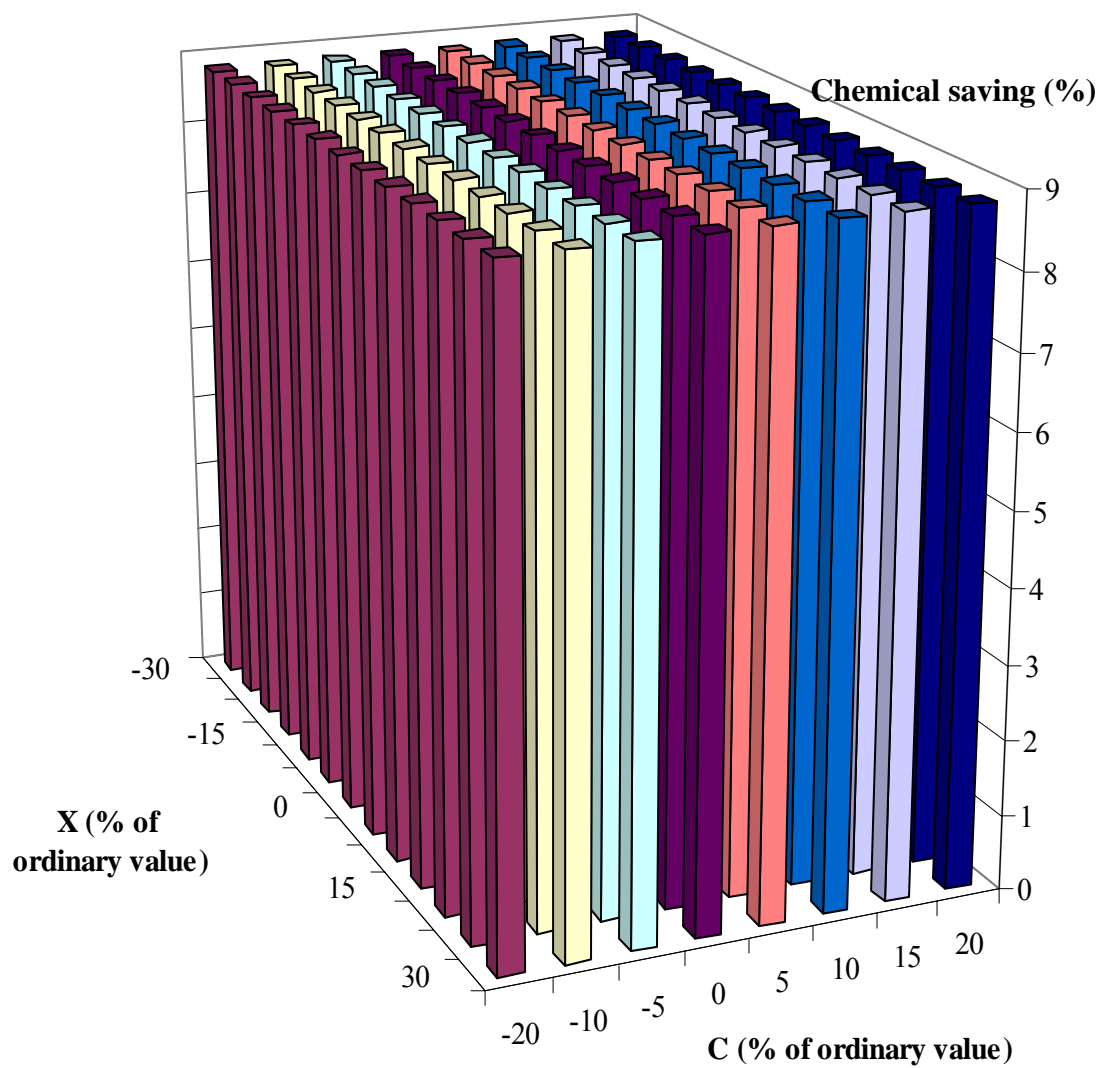


(b)

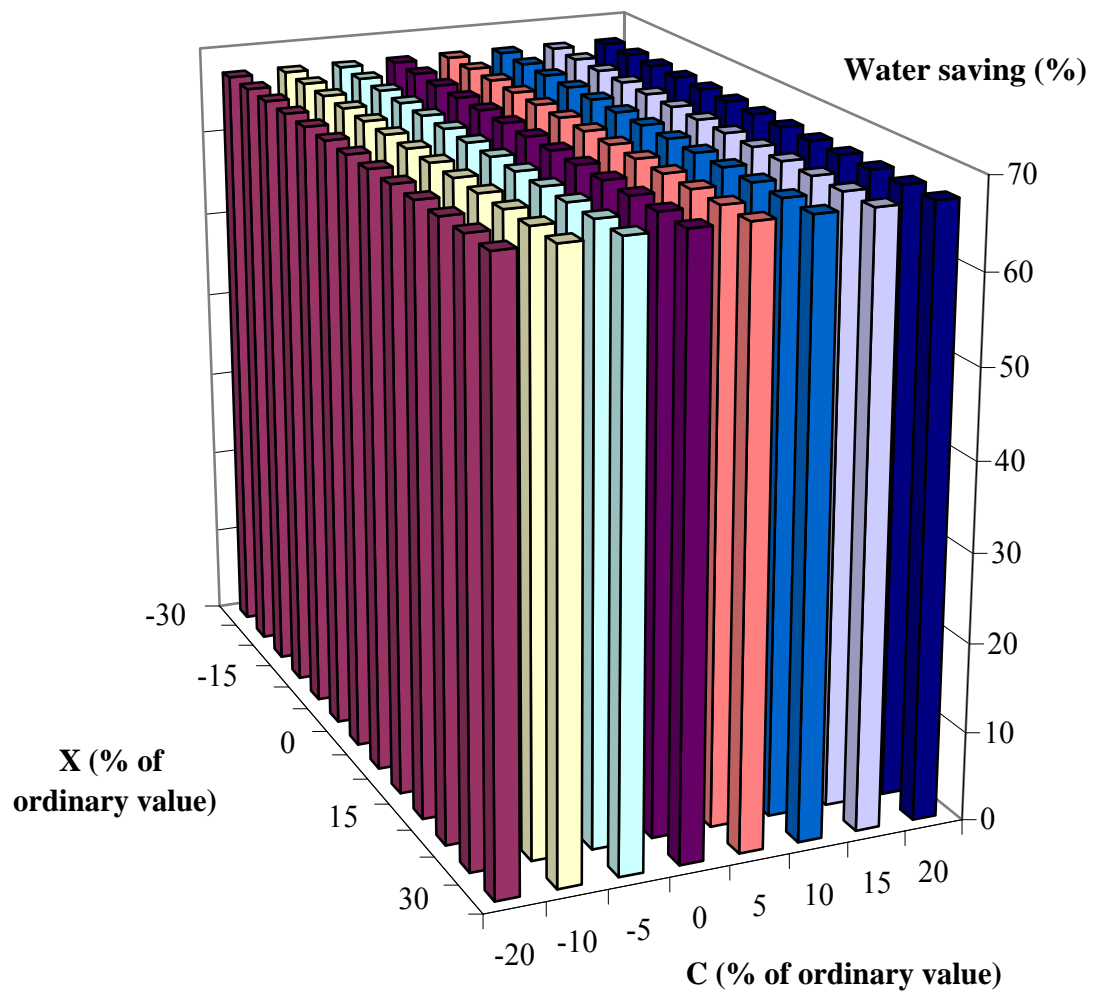




(c)



(d)



(e)

**Figure 5.36** Optimal draining ratios (%) (a), minimum concentrations (%g/mL.) (b), maximum contaminations (g/L.) (c), alkaline saving (%) (d) and water saving (%) (e) in the conditions of different initial concentrations and contaminations.

The chemical concentration and contamination have been varied in the range of 80%-120% of the ordinary concentration value and 70%-130% of the ordinary contamination value. The results show that the obtained optimal draining ratios in this variation are 1.70% in 80%-100%, 1.35%-2.03% (g/mL.), which have the draining patterns 3 cycles/time after 1 week pass. In addition, the minimum chemical concentration has an increasing trend continuously in a variation range because the initial chemical concentrations are higher values. Beside, the chemical contamination has an increasing trend when the initial contamination in the residual water is higher.

From figure 5.36, the results show that the chemical and water saving are respect to the optimal draining ratio. Since, the obtained optimal draining ratios in this case have only 1 value as 1.70%, the chemical and water saving have also 1 value as 8.82% and 67.36%.

## CHAPTER VI

### CONCLUSIONS AND RECOMMENDATIONS

#### 6.1 Conclusions

This work has studied the possibility of a recirculation of cleaning detergent and has estimated the optimal draining ratio to decrease chemical and water consumptions. To achieve these, the optimization has been applied to find the optimal draining values for alkali and acid cleaning steps in CIP process. To gather the actual data, The Thai medium dairy plant has been visited. A decentralized CIP process which obligates the cleanliness of three pasteurized milk tanks and seven packing machines has been investigated. The real operation data and microbial data of CIP chemicals have been collected during operation. The plant data have been collected and used to improve the process models and to determine the process parameters and initial conditions of cleaning operation whereas the microbial data have been determined and eventually found that the microorganism in the cleaning detergent under the plant operating condition cannot effect to products. Then, the proposed CIP process models have been applied to formulate the optimization problems.

To developed the process model, the compartment model which is one of the popular model for modeling the non-ideal reactor. All of The collected data have been summarized and used to determine the two important parameters which is the ratio of the bypass steam affected from the size of flowrate,  $\beta$ , and the ratio of the bypass steam affected from imperfect dissolution of contamination,  $\mu$ .

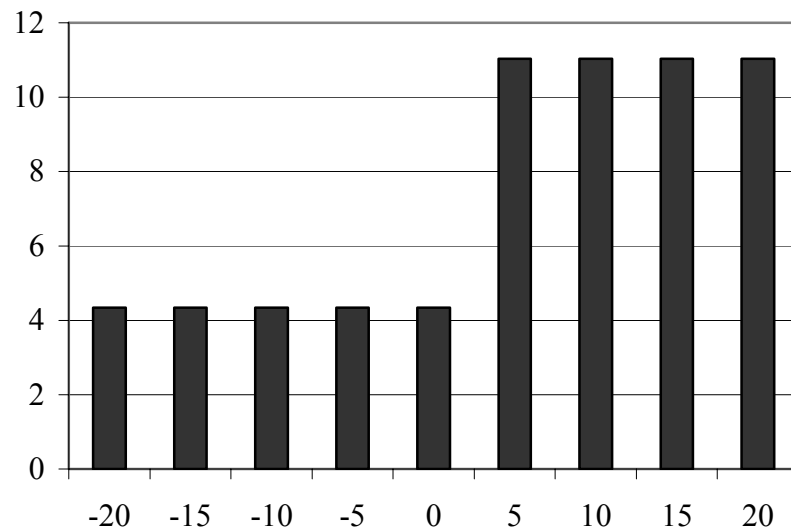
In this thesis, two optimization problems, alkaline and acid cases, have been formulated and solved to obtain the optimal draining ratios and suitable draining patterns. In optimization solving, the draining ratios and draining patterns are adjusted to match with the dynamic behaviors of the process under process constraints. The optimal draining ratios are determined for matching among the draining time, the minimum concentration and maximum contamination. At an optimal draining ratio,

the chemical discharging rises when the concentration is a minimum value and the contamination is a maximum value.

In the both cases, the chemical and water consumptions directly vary with the applied draining ratio. From optimization result, we have found that the problem in both cases have more than one optimum point, depend on a starting value of draining ratio. The global optimum point in first case has been obtained as 4.34% of alkaline draining ratio with 2 cycle/time after 1 week pass. Whereas, the global optimum point in second case has been obtained as 1.70% of acid draining ratio with 3 cycle/time after 1 week pass. These optimal solutions bring the chemical saving to a maximum value which is 11.39% and 8.82% for alkaline and acid cases respectively. In addition, maximum values of water saving are 55.49% and 67.36% for alkaline and acid cases consecutively.

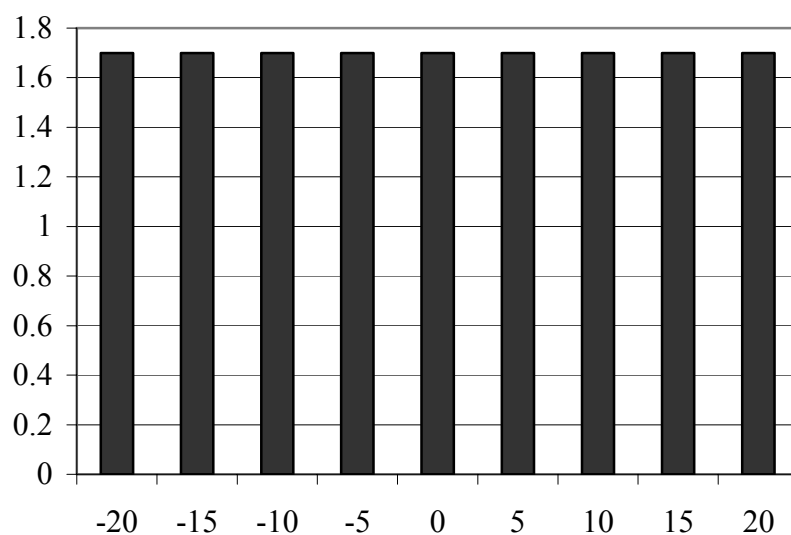
The study of the variation of the draining ratio shows the result that the draining ratios which apply in same draining pattern of the optimal draining ratio can be used in the range of 4.34%-16.67% and 1.70%-16.67% for alkaline and base cases respectively. The draining ratio which is less than the optimal draining ratio makes the chemical contamination over the maximum tolerance contamination whereas the draining ratio which is more than 16.67% makes this cleaning operation is no chemical and water saving.

The study of the variation of the initial concentration and contamination shows that the obtained optimal draining ratio is only depend on the initial concentration values. Since the chemical concentration is higher, the alkaline detergent can be used in more cleaning cycle before the concentration less than 1%,g/mL.



**Figure 6.1** Obtained optimal draining ratios (%) from different initial alkaline concentration values

In the acid cleaning step, there is no value changing of the optimal draining ratio because the chemical concentration is still not higher than the critical point. Therefore, the result has only 1 value of the obtained optimal draining ratio in the range of 80%-120% of the ordinary initial concentration value.



**Figure 6.2** Obtained optimal draining ratios (%) from different initial acid concentration values

## **6.2 Recommendations**

Since this research has focused on only a decentralized CIP process which obligates the equipment cleanliness of the end of the production system, for the future work, the CIP process which obligates the cleanliness of the beginning of the production system and the pasteurizer should also be integrated. The circulation between each other part can decrease more chemical and water consumptions, for example, leading the detergents from ending period of the pasteurizer cleaning which are immediately drained and low contaminations to reuse for the milk tank cleaning in the CIP process.



## REFERENCES

- Ana M. Eliceche, Sergio M. Corval'an and Pablo Mart'inez. Environmental life cycle impact as a tool for process optimization of a utility plant. Computers and Chemical Engineering 31 (2007): 648–656.
- Aziz, N. and Mujtaba, I. M. Optimal operation policies in batch reactors. Chemical Engineering Journal 85 (2002): 313-325.
- Banga, J. R. and Carrasco, E. F. Dynamic optimization of batch reactors using adaptive stochastic algorithms. Ind. Eng. Chem. Res. 36 (1997): 2252-2261.
- Banga, J. R., Canto, E. B., Moles, C. G. and Alonso, A. Dynamic optimization of bioprocesses: Efficient and robust numerical strategies. Journal of Biotechnology 117 (2005): 407-419.
- Biegler, L. T. Solution of dynamic optimization problems by successive quadratic programming and orthogonal collocation. Comput. Chem. Eng. 8 (1984): 243-248.
- Bryson, A. E. and Ho, Y. C. Applied Optimal Control. Washington DC: Hemisphere, 1975.
- Carlos E. Mariano-Romero, Victor H. Alcocer-Yamanaka and Eduardo F. Morales. Multi-objective optimization of water-using systems. European Journal of Operational Research 181 (2007): 1691–1707.
- Chen, C. T. and Hwang, C. Optimal control computation for differential-algebraic process systems with general constraints. Chem. Eng. Commun 97 (1990a): 9-26.

- Chen, C. T. and Hwang, C. Optimal on-off control for fed-batch fermentation processes. Ind. Eng. Chem. Res. 29 (1990b): 1869-1875.
- Cuthrell, J. E. and Biegler, L. T. Simultaneous optimization and solution methods for batch reactor control profiles. Comput. Chem. Eng. 13 (1989): 49-62.
- Edgar, T. F., Himmelblau, D. M. and Lasdon, L. S. Optimization of chemical processes 2nd edition. Singapore: McGraw-Hill, 2001.
- Forstmeier, M., Goers, B. and Wozny, G. Water network optimisation in the process industry-case study of a liquid detergent plant. Journal of Cleaner Production 13 (2005): 495-498.
- Forstmeier, M., Schipolowski, T., Goers B. and Wozny, G. Application of UF/NF for the Treatment of CIP (Cleaning In Place) Rinsing Water: case study in a liquid detergent production plant, Membranes in Drinking and Industrial Water Production, 3 (2003): 283-288.
- Genevieve Gesan-Guiziou, Evelyne Boyaval and Georges Daufin. Nanofiltration for the recovery of caustic cleaning-in-place solutions: robustness towards large variations of composition. Journal of Dairy Research 69 (2002): 633-643.
- Gerald Jödicke, Ulrich Fischer and Konrad Hungerbühler. Wastewater reuse: a new approach to screen for designs with minimal total costs. Computers and Chemical Engineering 25 (2001): 203–215.
- Goers, B., Mey, J. and Wozny, G. Optimised product and water recovery from batch-production rinsing waters. Waste Management 20 (2000): 651-658.
- Graßhoff, A. Enzymatic Cleaning of Milk Pasteurizers, Tran IChemE Part C Food and Bioprod Proc, 80 (2002) : 247-252.

- Hong, J. Optimal substrate feeding policy for a fed-batch fermentation with substrate and product inhibition kinetics. Biotechnol. Bioeng. 28 (1986): 1421-1431.
- Johanna Berlin, Ulf Sonesson and Anne-Marie Tillman. A life cycle based method to minimise environmental impact of dairy production through product sequencing. Journal of Cleaner Production 15 (2007): 347-356.
- John L. Ingraham and Catherine A. Ingraham, Introduction to microbiology 3<sup>rd</sup> edition. USA: Brooks/Cole-Thomson learning, 2004.
- Kapadi, M. D. and Gudi, R. D. Optimal control of fed-batch fermentation involving multiple feeds using differential evolution. Process Biochemistry 39 (2004): 1709-1721.
- Mahadevan, R. and Doyle III, F. J. On-line Optimization of Recombinant Product in a Fed-batch Bioreactor. Biotechnol. Prog. 19 (2003): 639-646.
- Modak, J. M. and Lim, H. C. Feedback optimization of fed-batch fermentation. Biotech. Bioeng. 30 (1987): 528-540.
- Bird, M.R. and Espig, S.W.P. Cost Optimization of Dairy Cleaning In Place (CIP) Cycles, Tran IChemE Part C Food and Bioprod Proc, 72 (1) (1994) : 17-20.
- Octave, L. Chemical reaction engineering 3<sup>rd</sup> edition. United States of America: John wiley & sons, inc, 1999.
- Palanki, S., Kravaris, C. and Wang, H. Y. Synthesis of state feedback laws for end-point optimization in batch processes. Chem. Eng. Sci. 48 (1993): 135-152.
- Palanki, S. and Vemuri, J. Optimal Operation of Semi-Batch Processes with a Single Reaction. Journal of Chemical Reactor Engineering 3 (2005): 1-23.
- Philip J. Bremer, Suzanne Fillery and A. James McQuillan. Laboratory scale Clean-In-Place (CIP) studies on the effectiveness of different caustic and acid

- wash steps on the removal of dairy biofilms. International Journal of Food Microbiology 106 (2006): 254 – 262.
- Pushpavanam, S., Rao, S. and Khan, I. Optimization of a biochemical fed-batch reactor using sequential quadratic programming. Ind. Eng. Chem. Res. 38 (1999): 1998-2004.
- Renfro, J. G., Morshedi, A. M. and Asbjornsen, O. A. Simultaneous optimization and solution of systems described by differential/algebraic equations. Comput. Chem. Eng. 11 (1987): 503-517.
- Riascos, C. A. M. and Pinto, J. M. Optimal control of bioreactors: a simultaneous approach for complex systems. Chemical Engineering Journal 99 (2004): 23-34.
- Sargent, R. W. H. Optimal control. Journal of Computational and Applied Mathematics 124 (2000): 361-371.
- Sarkar, D. and Modak, J. M. Optimization of fed-batch bioreactors using genetic algorithm: multiple control variables. Computers and Chemical Engineering 28 (2004): 789-798.
- Smets, I. Y., Claes, J. E., November, E. J., Bastin, G. P. and Van Impe, J. F. Optimal adaptive control of (bio)chemical reactor: past, present and future. Journal of Process Control 14 (2004): 795-805.
- Srinivasan, B., Palanki, D. and Bonvin, D. Dynamic optimization of batch processes I Characterization of the nominal solution. Computer and Chemical Engineering 27 (2003): 1-26.
- Van Asselt, A. J., Van Houwelingen, G. and Te Giffel., M. C. Monitoring System for Improving Cleaning Efficiency of Cleaning-In-Place Processes in Dairy Environments, Tran IChemE Part C Food and Bioprod Proc. 80 (4) (2002): 276-280.

Van der Bruggen, B. and Braeken, L. The challenge of zero discharge: from water balance to regeneration. Desalination 188 (2006): 177–183.

Xiong, Z. and Zhang, J. Neural network model-based on-line re-optimization control of fed-batch processes using a modified iterative dynamic programming algorithm. Chemical Engineering and Processing 44 (2005): 477-484.

Zuo, K. and Wu, W. T. Semi-realtime optimization and control of a fed-batch fermentation system. Computer and Chemical Engineering 24 (2000): 1105-1109

## **APPENDICES**

# APPENDIX A

## DATA COLLECTION

**Table A.1** flowrate of detergent during pasteurized milk tanks cleaning and packing machines cleaning.

No. of sample	Flowrate during pasteurized milk tanks cleaning	Flowrate during packing machines cleaning
1	216.56	112.92
2	214.72	113.44
3	197.28	111.02
4	188.97	97.444
5	195.04	80.527
6	191.45	113.54
7	193.08	91.365
8	189.04	99.048
9	192.26	118.48
10	215.81	111.16
11	185.83	90.149
12	209.33	93.66
13	201.77	81.355
14	206.79	102.34
15	207.44	103.36
<i>average</i>	<i>200.36</i>	<i>101.32</i>

**Table A.2** Concentration of alkaline of flowrate during pasteurized milk tanks cleaning after production ending.

Cleaning time (min)	No. of concentration data set					<i>average</i>
	1	2	3	4	5	
0	1.60	1.52	1.74	1.90	1.62	<b><i>1.68</i></b>
2	1.34	1.30	1.47	1.60	1.30	<b><i>1.40</i></b>
4	1.31	1.65	1.36	1.51	1.25	<b><i>1.42</i></b>
6	1.28	1.26	1.29	1.35	1.20	<b><i>1.28</i></b>
8	1.12	1.35	1.28	1.32	1.20	<b><i>1.25</i></b>
10	1.13	1.29	1.29	1.41	1.20	<b><i>1.26</i></b>

**Table A.3** Concentration of alkaline of flowrate during packing machines cleaning after production ending.

Cleaning time (min)	No. of concentration data set					<i>average</i>
	1	2	3	4	5	
0	1.09	1.00	1.31	1.42	1.35	<b><i>1.23</i></b>
2	0.90	0.75	1.11	1.21	1.11	<b><i>1.02</i></b>
4	0.87	0.77	1.09	1.15	1.02	<b><i>0.98</i></b>
6	0.86	0.72	1.03	1.06	1.02	<b><i>0.94</i></b>
8	0.85	0.76	1.00	1.04	0.99	<b><i>0.93</i></b>
10	0.86	0.76	0.97	1.01	0.99	<b><i>0.92</i></b>



**Table A.4** Concentration of acid of flowrate during packing machines cleaning before production starting.

Cleaning time (min)	No. of concentration data set					average
	1	2	3	4	5	
0	1.80	1.15	1.83	1.59	1.66	<b>1.61</b>
2	1.55	0.93	1.39	1.35	1.42	<b>1.33</b>
4	1.44	0.89	1.35	1.20	1.35	<b>1.25</b>
6	1.43	0.88	1.32	1.14	1.34	<b>1.22</b>
8	1.47	0.86	1.33	1.14	1.34	<b>1.23</b>
10	1.39	0.86	1.32	1.12	1.34	<b>1.21</b>

**Table A.5** Concentration of acid of flowrate during pasteurized milk tanks cleaning after production ending.

Cleaning time (min)	No. of concentration data set					average
	1	2	3	4	5	
0	1.44	1.67	1.42	1.56	1.38	<b>1.49</b>
2	1.24	1.39	1.31	1.24	1.21	<b>1.28</b>
4	1.21	1.38	1.14	1.15	1.22	<b>1.22</b>
6	1.27	1.28	1.15	1.14	1.19	<b>1.21</b>
8	1.28	1.29	1.01	1.14	1.20	<b>1.18</b>
10	1.23	1.31	1.01	1.14	1.22	<b>1.18</b>

**Table A.6** Concentration of acid of flowrate during packing machines cleaning after production ending.

Cleaning time (min)	No. of concentration data set					<i>average</i>
	1	2	3	4	5	
0	1.31	1.10	1.06	1.14	1.36	<b><i>1.19</i></b>
2	1.21	0.85	0.95	1.05	1.05	<b><i>1.02</i></b>
4	1.23	0.65	0.94	0.99	1.03	<b><i>0.97</i></b>
6	1.19	0.75	0.81	0.95	1.03	<b><i>0.95</i></b>
8	1.17	0.75	0.81	0.93	1.03	<b><i>0.94</i></b>
10	1.11	0.75	0.81	0.93	1.01	<b><i>0.92</i></b>

**Table A.7** Contamination of alkaline of flowrate during pasteurized milk tanks cleaning after production ending.

Cleaning time (min)	No. of contamination data set					<i>average</i>
	1	2	3	4	5	
0	0.41	1.25	1.10	0.90	0.54	<b><i>0.84</i></b>
2	2.08	1.56	1.51	1.50	1.42	<b><i>1.61</i></b>
4	2.19	2.24	1.74	1.21	1.50	<b><i>1.78</i></b>
6	2.00	2.52	1.64	1.70	1.84	<b><i>1.94</i></b>
8	2.26	3.17	2.40	2.40	1.96	<b><i>2.44</i></b>
10	1.84	3.00	2.50	2.65	2.60	<b><i>2.52</i></b>

**Table A.8** Contamination of alkaline of flowrate during packing machines cleaning after production ending.

Cleaning time (min)	No. of contamination data set					average
	1	2	3	4	5	
0	0.41	1.25	1.10	0.90	0.54	<b>1.29</b>
2	2.08	1.56	1.51	1.50	1.42	<b>1.52</b>
4	2.19	2.24	1.74	1.21	1.50	<b>2.12</b>
6	2.00	2.52	1.64	1.70	1.84	<b>2.28</b>
8	2.26	3.17	2.40	2.40	1.96	<b>2.19</b>
10	1.84	3.00	2.50	2.65	2.60	<b>2.48</b>

**Table A.9** Contamination of acid of flowrate during packing machines cleaning before production starting.

Cleaning time (min)	No. of contamination data set					average
	1	2	3	4	5	
0	0.40	0.34	0.57	0.20	0.74	<b>0.45</b>
2	0.30	0.21	0.34	0.14	0.91	<b>0.38</b>
4	0.10	0.34	0.34	0.14	0.21	<b>0.23</b>
6	0.09	0.03	0.05	0.12	0.04	<b>0.07</b>
8	0.05	0.05	0.09	0.07	0.05	<b>0.06</b>
10	0.09	0.05	0.06	0.04	0.09	<b>0.07</b>

**Table A.10** Contamination of acid of flowrate during pasteurized milk tanks cleaning after production ending.

Cleaning time (min)	No. of contamination data set					average
	1	2	3	4	5	
0	0.24	0.08	0.04	0.08	0.09	<b>0.11</b>
2	0.15	0.63	0.07	0.66	0.23	<b>0.35</b>
4	0.72	1.05	0.21	0.40	0.75	<b>0.63</b>
6	0.64	0.88	0.30	0.96	0.44	<b>0.64</b>
8	0.71	0.96	0.34	0.63	0.50	<b>0.63</b>
10	0.33	0.93	0.34	0.60	0.60	<b>0.56</b>

**Table A.11** Contamination of acid of flowrate during packing machines cleaning after production ending.

Cleaning time (min)	No. of contamination data set					average
	1	2	3	4	5	
0	0.08	0.23	0.03	0.65	0.40	<b>0.28</b>
2	0.26	0.06	0.49	0.80	0.52	<b>0.43</b>
4	0.13	0.26	0.55	0.75	0.52	<b>0.44</b>
6	0.19	0.40	0.44	0.85	0.62	<b>0.50</b>
8	0.49	0.27	0.54	1.00	0.76	<b>0.61</b>
10	0.04	0.40	0.17	0.88	0.72	<b>0.44</b>

# APPENDIX B

## MICROBIAL GROWTH

Microbial or Microorganisms are living organisms that are individually too small to see with the naked eye. The unit of measurement used for microorganisms is the micrometer ( $\mu\text{m}$ );  $1 \mu\text{m} = 0.001$  millimeter;  $1 \text{ nanometer (nm)} = 0.001 \mu\text{m}$ . Microorganisms are found everywhere and are essential to many of our planets life processes. With regards to the food industry, they can cause spoilage, prevent spoilage through fermentation, or can be the cause of human illness.

There are a number of factors that affect the survival and growth of microorganisms in food. The parameters that are inherent to the food, or intrinsic factors, include the following:

*Nutrient:* While the nutrient requirements are quite organism specific, the microorganisms of importance in foods require the following:

- water
- energy source
- carbon/nitrogen source
- vitamins
- minerals

*Moisture Content:* All microorganisms require water but the amount necessary for growth varies between species. The amount of water that is available in food is expressed in terms of water activity ( $a_w$ ), where the  $a_w$  of pure water is 1.0. Each microorganism has a maximum, optimum, and minimum  $a_w$  for growth and survival. Generally bacteria dominate in foods with high  $a_w$  (minimum approximately 0.90  $a_w$ ) while yeasts and moulds, which require less moisture, dominate in low  $a_w$  foods (minimum 0.70  $a_w$ ). The water activity of fluid milk is approximately 0.98  $a_w$ .

*pH*: Most microorganisms prefer approximately a neutral pH optimum (pH 6-7.5). Yeasts are able to grow in a more acid environment compared to bacteria. Moulds can grow over a wide pH range but prefer only slightly acid conditions. Milk has a pH of 6.6 which is ideal for the growth of many microorganisms.

*Available Oxygen*: Microorganisms can be classified according to their oxygen requirements necessary for growth and survival:

- *Obligate Aerobes*: Oxygen required.
- *Facultative*: Grow in the presence or absence of oxygen.
- *Microaerophilic*: Grow best at very low levels of oxygen.
- *Aerotolerant Anaerobes*: Oxygen not required for growth but not harmful if present.
- *Obligate Anaerobes*: Grow only in complete absence of oxygen; if present it can be lethal.

*Biological Structures*: Physical barriers such as skin, rinds, feathers, etc. have provided protection to plants and animals against the invasion of microorganisms. Milk, however, is a fluid product with no barriers to the spreading of microorganisms throughout the product.

*Antimicrobial Constituents*: As part of the natural protection against microorganisms, many foods have antimicrobial factors. Milk has several nonimmunological proteins which inhibit the growth and metabolism of many microorganisms including the following most common:

- *lactoperoxidase*
- *lactoferrin*
- *lysozyme*
- *xanthine*

Where the intrinsic factors are related to the food properties, the extrinsic factors are related to the storage environment. These would include temperature, relative humidity, and gases that surround the food.

*Temperature:* As a group, microorganisms are capable of growth over an extremely wide temperature range. However, in any particular environment, the types and numbers of microorganisms will depend greatly on the temperature. According to temperature, microorganisms can be placed into one of three broad groups:

- *Psychrotrophs:* Optimum growth temperatures 20°C to 30°C capable of growth at temperatures less than 7°C. Psychrotrophic organisms are specifically important in the spoilage of refrigerated dairy products.
- *Mesophiles:* Optimum growth temperatures 30°C to 40°C ; do not grow at refrigeration temperatures.
- *Thermophiles:* Optimum growth between 55°C and 65°C.

It is important to note that for each group, the growth rate increases as the temperature increases only up to an optimum, after which it rapidly declines.

Microbial growth involves an increase in the number of cells rather than in the size of individual cells. Growth of most microorganisms occurs by binary fission. Cell division and chromosome replication are usually coordinately regulated.

*Measuring microbial growth* by increases in:

1. Mass a broth culture of cells can be grown, then dehydrated and the dry weight of the cells determined by weighing them.
2. Number of cells in a broth culture, three approaches can be taken:
  - *Direct count.* Cells are counted using a Neubauer chamber (which allows one to count the number of cells in a known volume of fluid)

- *Viable count.* Cells are diluted and plated on a suitable culture medium, and then the number of resulting colonies counted.
- *Total count.* The number of cells can be estimated by determining the turbidity of the culture using a colorimeter.

### 3. Microbial growth curve

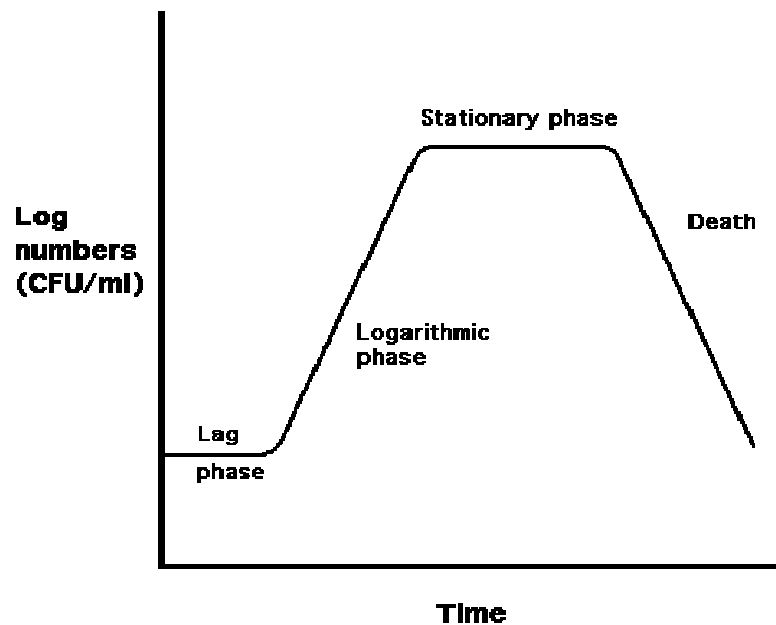


Figure B.1 Microbial growth curve (reference: [www.biologie.uni-hamburg.de](http://www.biologie.uni-hamburg.de))

- *Lag phase.* Cells get ready to synthesize components needed for growth.
- *Log phase (or exponential phase).* Rapid proliferation (exponential or logarithmic). In this phase, the total number of cells in the population is equal to two raised to an exponent as equation 3.9.

$$N=2^k \times N_0 \quad (\text{B.1})$$

Where  $N$  = number of cells in the culture

$N_0$  = initial cell number

$k$  = the number of doubling times that have passed



- *Stationary phase* Cell proliferation is balanced by cell death caused by nutrient depletion or accumulation of metabolic by-products.
- *Death phase* Rapid (logarithmic) cell death occurs.

# APPENDIX C

## STANDARD PLATE COUNT METHOD

(Reference: Introduction to microbiology)

The Standard Plate Count (SPC) method is one of the methods for measuring, or counting, the number of microbial cells, or colony, in a population, normally has a strong relationship with the keeping quality of the product. In this method, all viable microbial cells in samples are counted by plate counting technique. Steps of the plate counting technique in SPC method are described as following.

### Steps of the plate counting technique in SPC method

1. Preparing standard plate count agar:
  - 1.1. Mixing the standard plate count agar follow defining on a label.
  - 1.2. Sanitizing the SPC agar by heating at 121°C for 15 min.
  - 1.3. Letting it free to cools down until it forms to agar.
  - 1.4. Bringing to refrigerator to keep temperature, this prepared SPC agar can be used for 1 month after preparing.
  - 1.5. Before using, the agar is melted by heating in boiled water and immersing in the water at 45°C estimately.
2. Diluting the collected samples follow the number of microbial cells or colonies, generally dilute to  $10^{-4}$ .
3. Pouring 1 ml of each samples into petri dish and mixing with 10 ml melted SPC agar.

4. Letting it for cooling down.
5. Leading it to incubate about 35-37°C for 48 hour.
6. Counting the microbial cells or colony

The advantage of the plate count method is its extreme sensitivity. Even a single live cell can be detected with the appropriate medium and incubation conditions. Moreover, a plate count does not require complicated equipment. On the negative side, doing plate counts is slow and tedious and not very accurate. Accuracy increases with the numbers of colonies counted because of sampling error (the inevitable inaccuracy, because all samples are not completely representative of the total population). Ninety-five percent of the time, the true number of viable cells does not differ from the number counted by more than twice the square root of the number of colonies counted.

## VITA

Mr. Butsakon Siriburanon was born in Bangkok on August 25, 1982. He graduated the Bachelor Degree in department of Chemical Technology from Chulalongkorn University in April 2004. After that he studied for Master Degree in Chemical Engineering, Chulalongkorn University in May 2004.