

บรรณานุกรม

ภาษาไทย

สมควร บูรมินเนนทร์, คร. ๒๕๑๓ Computer System เล่ม ๑, ๒ ศูนย์คอมพิวเตอร์
บัณฑิตวิทยาลัย จุฬาลงกรณ์มหาวิทยาลัย กรุงเทพฯ.

REFERENCES

- Adtech, Inc. 1972. The Model 40 Education Microcomputer. Hawaii:
Adtech, Inc.
- Frederick Electronics, Co. 1968. Model 700A Code Converter. Maryland:
Frederic Electronics, Co.
- Lewin, Douglas. 1970. Logical Design of Switching Circuits. London:
Thomas Nelson and Sons. Ltd.
- Linford, John. 1973. Code Conversion With Semiconductor Read Only
Memories. Arizona: Motorola Semiconductor Products. Inc.
- Marcus, Mitchell P. 1967. Switching Circuits for Engineers. 2d ed.
New Jersey : Prentice Hall, Inc.
- Millman, Jacob., and Taub, Herbert. 1965. Pulse, Digital and Switching
Waveforms. New York: Mc Graw-Hill Book Co., Inc.
- Morris, Robert L., and Miller, John R. 1971. Designing with TTL Integ-
rated Circuits. New York: Mc Graw-Hill Book Co., Inc.
- NS National. 1974. Digital Integrated Circuits. California: National
Semiconductor Co.
- Quon, R.D.S., Roelofs, T.H., and Weldon, Jr., E.J. 1971. Elements of
Computer Logic. Hawaii: Adtech, Inc.
- Teletype, Co. 1964. 32 and 33 Typing Unit Principles of Operation.
Illinois: Teletype, Co.
- Ward, Brice. 1971. Computer Technician's Handbook. Pennsylvania: Tab
Books.
- Weldon, Jr., E.J. 1973. Digital Computer System Fundamentals. Hawaii:
Adtech, Inc.

การเชื่อมต่อ ก.

Connection Diagrams ของ IC ที่ใช้

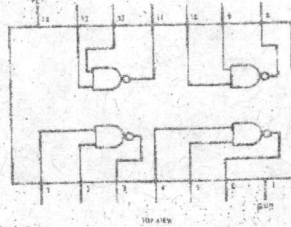

DM5400/DM7400(SN5400/SN7400)

quadruple 2-input NAND gate

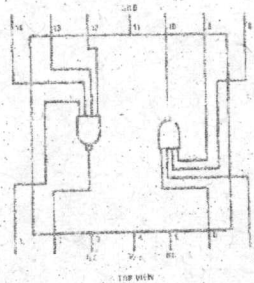

DM5420/DM7420(SN5420/SN7420)

dual 4-input NAND gate

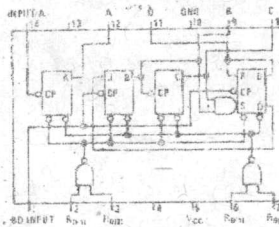

DM5490/DM7490(SN5490/SN7490)

decade counter

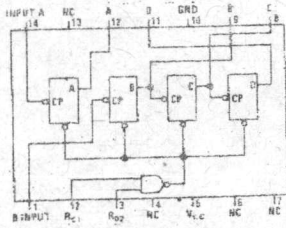

DM5493/ DM7493(SN5493/SN7493)
4 - bit binary counter

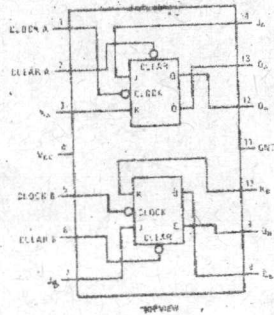

DM5473 / DM7473(SN5473/SN7473)
dual JK master/slave flip flop

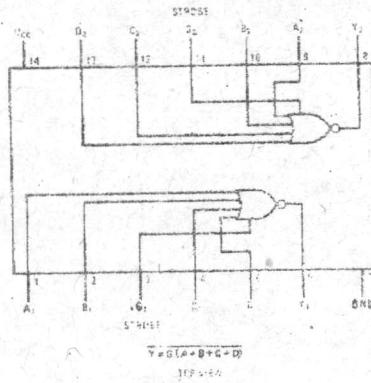

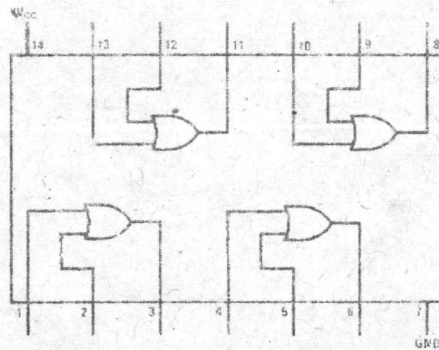

TOP VIEW

DM5432/DM7432(SN5432/SN7432)

quad 2-input OR gate

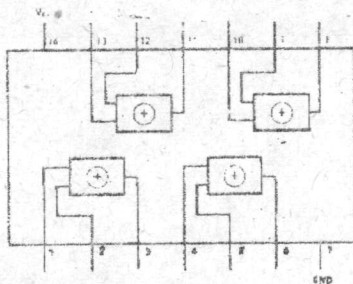

TOP VIEW

DM5486/DM7486(SN5486/SN7486)

quad EXCLUSIVE-OR gate

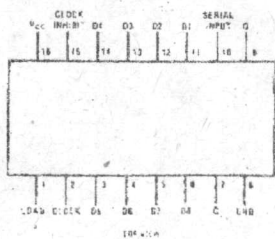
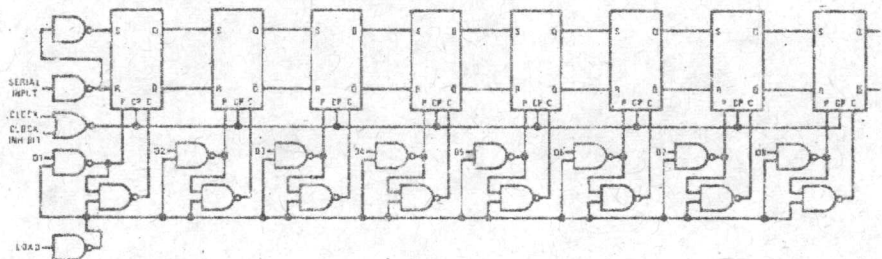

DM7590/DM8590(SN54165/SN74165)

8-bit parallel-in serial-out shift register

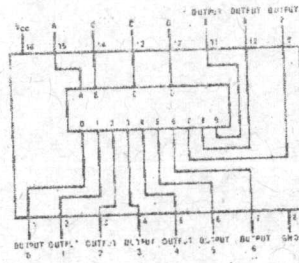
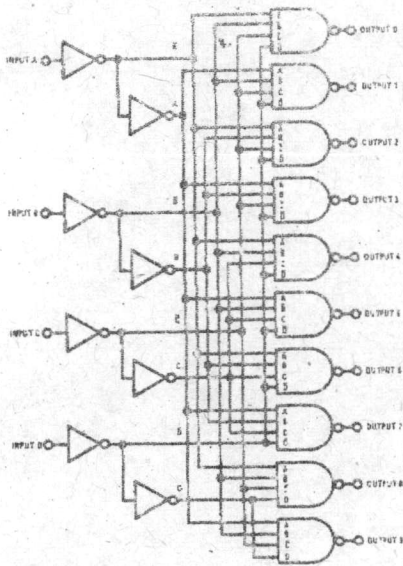

INPUTS				OUTPUTS									
D	C	B	A	0	1	2	3	4	5	6	7	8	9
0	0	0	0	1	0	0	0	0	0	0	0	0	0
0	0	0	1	0	1	0	0	0	0	0	0	0	0
0	0	1	0	0	0	1	0	0	0	0	0	0	0
0	0	1	1	0	0	0	1	0	0	0	0	0	0
0	1	0	0	0	0	0	0	1	0	0	0	0	0
0	1	0	1	0	0	0	0	0	1	0	0	0	0
0	1	1	0	0	0	0	0	0	0	1	0	0	0
0	1	1	1	0	0	0	0	0	0	0	1	0	0
1	0	0	0	0	0	0	0	0	0	0	0	1	0
1	0	0	1	0	0	0	0	0	0	0	0	0	1
1	0	1	0	0	0	0	0	0	0	0	0	0	0
1	0	1	1	0	0	0	0	0	0	0	0	0	0
1	1	0	0	0	0	0	0	0	0	0	0	0	0
1	1	0	1	0	0	0	0	0	0	0	0	0	0
1	1	1	0	0	0	0	0	0	0	0	0	0	0
1	1	1	1	0	0	0	0	0	0	0	0	0	0

DM5442/DM7442 (SN5442/SN7442)

BCD-to-decimal decoder

ภาคผนวก ข.

การทอวงจรและ Truth Table ของลอจิกที่ใช้

NAND Gate

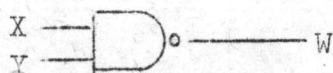

X	Y	W
L	L	H
L	H	H
H	L	H
H	H	L

Inverter (NOT Gate)

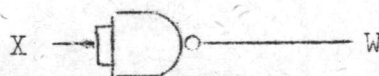
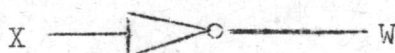

X	W
L	H
H	L

OR Gate

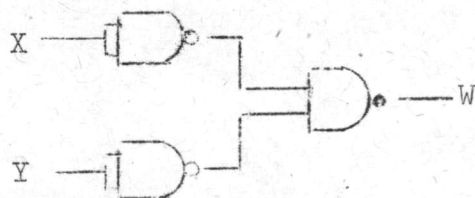

X	Y	W
L	L	L
L	H	H
H	L	H
H	H	H

RS Flip Flop

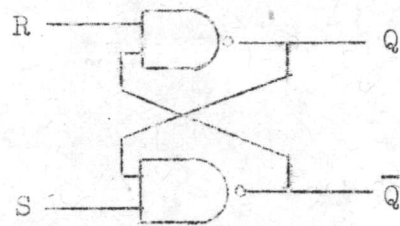

R	S	Q	\bar{Q}
L	L	H	H
L	H	H	L
H	L	L	H
H	H	Q	\bar{Q}

RST Flip Flop

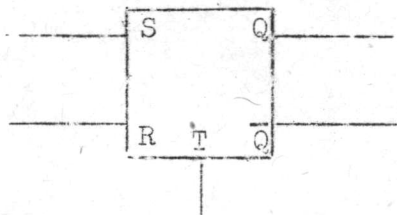
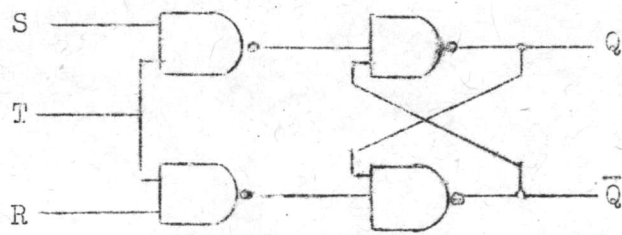

R	S	T = 1	
		Q	\bar{Q}
L	L	Q	\bar{Q}
L	H	H	L
H	L	L	H
H	H	L	L

JK Flip Flop

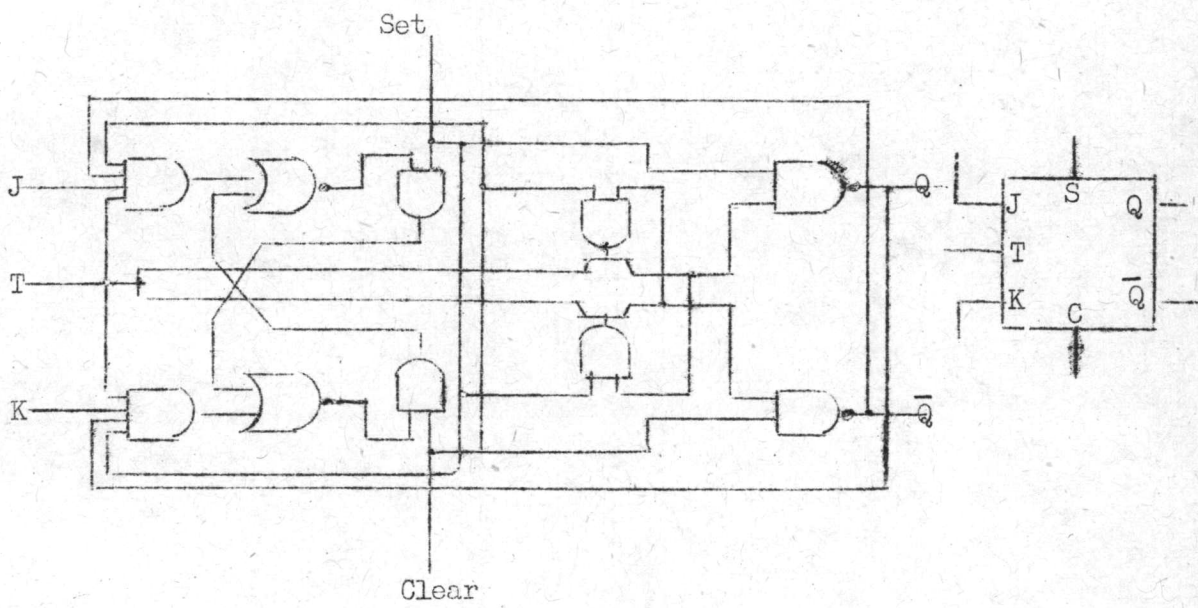

J	K	After Clk	
		Q	\bar{Q}
L	L	Q	\bar{Q}
L	H	L	H
H	L	H	L
H	H	\bar{Q}	Q

S	C	Q	\bar{Q}
L	L	?	?
L	H	0	1
H	L	1	0
H	H	Q	\bar{Q}

Divide-by-ten Counter

เมื่อมี Clock ทาง Input 10 Clock จึงจะทำให้ทาง Output มี Clock เกิดขึ้น 1 Clock

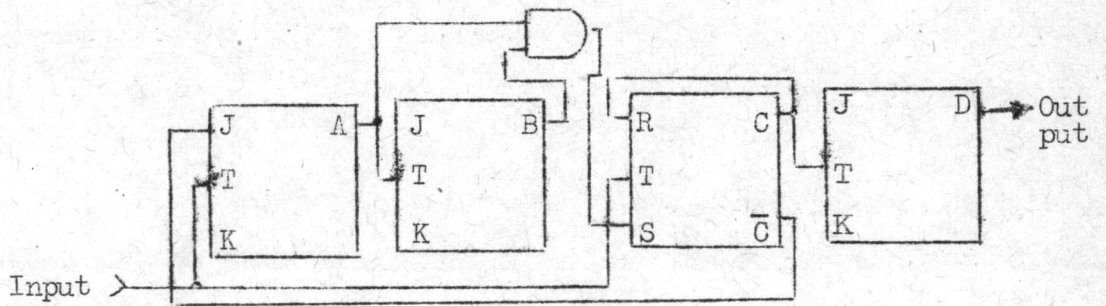

Clock	D	C	B	A
0	L	L	L	L
1	L	L	L	H
2	L	L	H	L
3	L	L	H	H
4	L	H	L	L
5	H	L	L	L
6	H	L	L	H
7	H	L	H	L
8	H	L	H	H
9	H	H	L	L

BCD Decode Counter

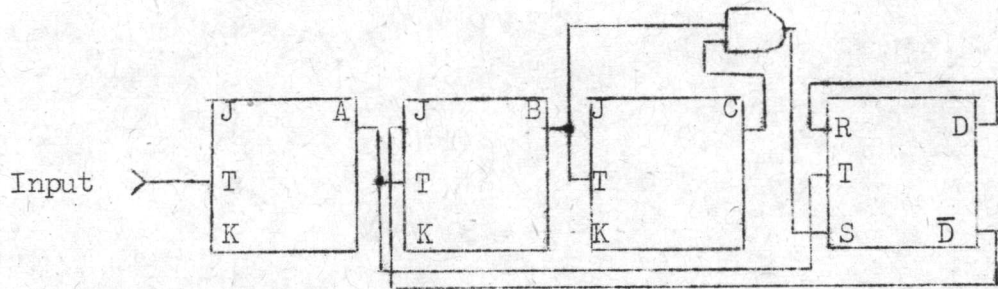

Count	D	C	B	A
0	L	L	L	L
1	L	L	L	H
2	L	L	H	L
3	L	L	H	H
4	L	H	L	L
5	L	H	L	H
6	L	H	H	L
7	L	H	H	H
8	H	L	L	L
9	H	L	L	H

4-bit Binary Counter

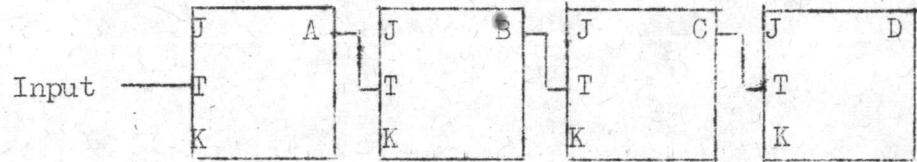

Count	D	C	B	A
0	L	L	L	L
1	L	L	L	H
2	L	L	H	L
3	L	L	H	H
4	L	H	L	L
5	L	H	L	H
6	L	H	H	L
7	L	H	H	H
8	H	L	L	L
9	H	L	L	H
10	H	L	H	L
11	H	L	H	H
12	H	H	L	L
13	H	H	L	H
14	H	H	H	L
15	H	H	H	H

2-bit Binary Counter

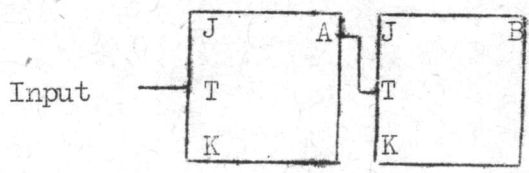

Count	B	A
0	L	L
1	L	H
2	H	L
3	H	H

Exclusive - OR Gate

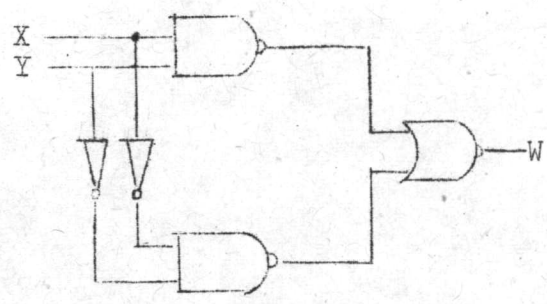

X	Y	W
0	0	0
0	1	1
1	0	1
1	1	0

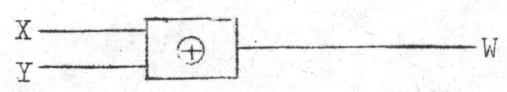
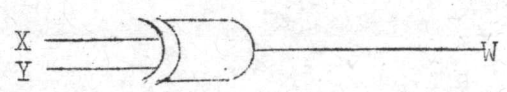

ROM Binary/BCD Converter

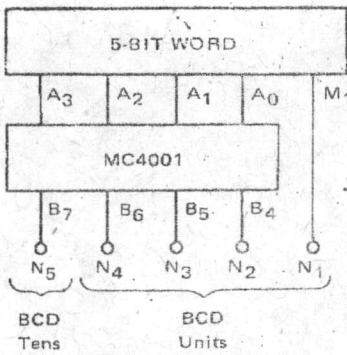
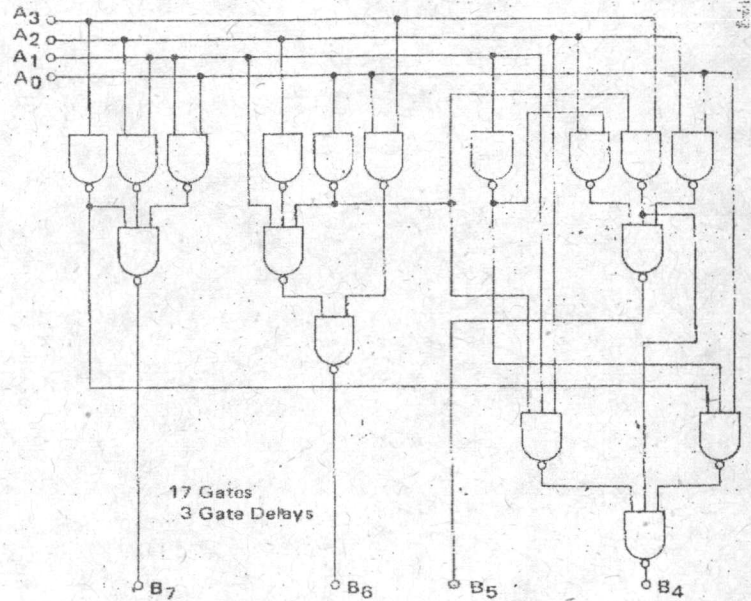
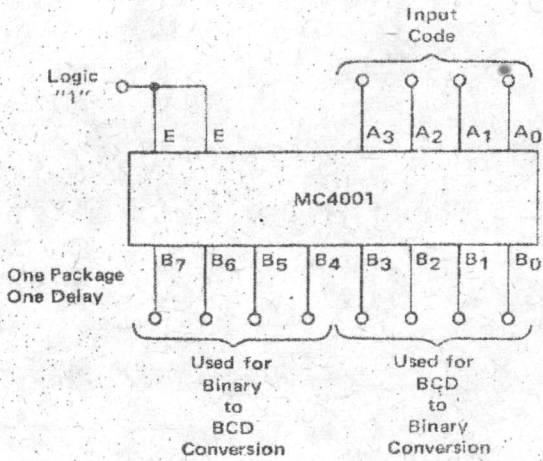

Decimal Number	Binary Number					Tens Digit BCD Number				Units Digit BCD Number			
	M ₅	M ₄	M ₃	M ₂	M ₁	N ₈	N ₇	N ₆	N ₅	N ₄	N ₃	N ₂	N ₁
0	0	0	0	0	0	0	0	0	0	0	0	0	0
1	0	0	0	0	1	0	0	0	0	0	0	0	1
2	0	0	0	1	0	0	0	0	0	0	0	1	0
3	0	0	0	1	1	0	0	0	0	0	0	1	1
4	0	0	1	0	0	0	0	0	0	0	1	0	0
5	0	0	1	0	1	0	0	0	0	0	1	0	1
6	0	0	1	1	0	0	0	0	0	0	1	1	0
7	0	0	1	1	1	0	0	0	0	0	1	1	1
8	0	1	0	0	0	0	0	0	0	1	0	0	0
9	0	1	0	0	1	0	0	0	0	1	0	0	1
10	0	1	0	1	0	0	0	0	1	0	0	0	0
11	0	1	0	1	1	0	0	0	1	0	0	0	1
12	0	1	1	0	0	0	0	0	1	0	0	1	0
13	0	1	1	0	1	0	0	0	1	0	0	1	1
14	0	1	1	1	0	0	0	0	1	0	1	0	0
15	0	1	1	1	1	0	0	0	1	0	1	0	1
16	1	0	0	0	0	0	0	0	1	0	1	1	0
17	1	0	0	0	1	0	0	0	1	0	1	1	1
18	1	0	0	1	0	0	0	0	1	1	0	0	0
19	1	0	0	1	1	0	0	0	1	1	0	0	1

Decimal Value of 5-Bit Word	MC4001													
	Address				Output									
	A ₃	A ₂	A ₁	A ₀	B ₇	B ₆	B ₅	B ₄						
0	0	0	0	0	0	0	0	0	0					
1	0	0	0	0	0	0	0	0	0					
2	0	0	0	0	1	0	0	0	0					
3	0	0	0	0	1	0	0	0	1					
4	0	0	0	1	0	0	0	0	1					
5	0	0	0	1	0	0	0	0	1					
6	0	0	0	1	1	0	0	0	1					
7	0	0	0	1	1	0	0	0	1					
8	0	1	0	0	0	0	0	1	0					
9	0	1	0	0	0	0	0	1	0					
10	0	1	0	1	1	0	0	0	0					
11	0	1	0	1	1	0	0	0	1					
12	0	1	1	0	0	1	0	0	0					
13	0	1	1	0	1	0	0	0	1					
14	0	1	1	1	1	0	0	1	0					
15	0	1	1	1	1	1	0	1	0					
16	1	0	0	0	0	1	0	1	1					
17	1	0	0	0	1	0	1	1	1					
18	1	0	0	1	1	1	1	0	0					
19	1	0	0	1	1	1	1	0	0					



ประวัติการศึกษา

นายภูดเกียรติ กรีพานิช จบการศึกษาระดับปริญญาตรี วิทยาศาสตรบัณฑิต (สาขาบริหาร) จากมหาวิทยาลัยมหิดล พ.ศ. ๒๕๑๐ ปัจจุบันรับราชการในตำแหน่ง วิทยากรโท สำนักนโยบายและแผน กรุงเทพมหานคร.

