

การทำให้บริสุทธิ์ด้วยวิธีโครมาโทกราฟีของแกมมาออร์ชันอลที่ได้  
จากผลพลอยได้ของการกลั่นน้ำมันรำข้าว

นางสาวอัญชญา เอนจินทะ

วิทยานิพนธ์นี้เป็นส่วนหนึ่งของการศึกษาตามหลักสูตรปริญญาวิทยาศาสตรมหาบัณฑิต  
สาขาวิชาวิศวกรรมเคมี ภาควิชาวิศวกรรมเคมี  
คณะวิศวกรรมศาสตร์ จุฬาลงกรณ์มหาวิทยาลัย  
ปีการศึกษา 2556

บทคัดย่อและแฟ้มข้อมูลฉบับเต็มของวิทยานิพนธ์นี้พร้อมทั้งเอกสารประกอบที่เกี่ยวข้อง  
เป็นแฟ้มข้อมูลของนิสิตเจ้าของวิทยานิพนธ์ที่ส่งผ่านทางบัณฑิตวิทยาลัย

The abstract and full text of theses from the academic year 2011 in Chulalongkorn University Intellectual Repository (CUIR)  
are the thesis authors' files submitted through the Graduate School.

CHROMATOGRAPHIC PURIFICATION OF GAMMA ORYZANOL  
FROM BY-PRODUCTS OF RICE BRAN OIL REFINERY

Miss Anchana Anjinta

A thesis Submitted in Partial Fulfillment of the Requirements  
for the Degree of Master of Engineering Program in Chemical Engineering  
Department of Chemical Engineering  
Faculty of Engineering  
Chulalongkorn University  
Academic Year 2013  
Copyright of Chulalongkorn University

Thesis Title	CHROMATOGRAPHIC PURIFICATION OF GAMMA ORYZANOL FROM BY-PRODUCTS OF RICE BRAN OIL REFINERY
By	Miss Anchana Anjinta
Field of Study	Chemical Engineering
Thesis Advisor	Associate Professor Artiwan Shotipruk, Ph.D

---

Accepted by the Faculty of Engineering, Chulalongkorn University in Partial Fulfillment of the Requirements for the Master's Degree

..... Dean of the Faculty of Engineering  
(Professor Bundhit Eua-Arporn, Ph.D.)

#### THESIS COMMITTEE

..... Chairman  
(Associate Professor Muenduen Phisalaphong, Ph.D.)

..... Thesis Advisor  
(Associate Professor Artiwan Shotipruk, Ph.D.)

..... Examiner  
(Assistant Professor Kasidit Nootong, Ph.D.)

..... External Examiner  
(Duangkamol Ruen-ngam, Ph.D.)

ัญชานาเอนจินทะ : การทำให้บริสุทธิ์ด้วยวิธีโครมาโทกราฟีของแกมมาออริซานอลที่ได้  
จากผลพลอยได้ของการกลั่นน้ำมันรำข้าว (CHROMATOGRAPHIC  
PURIFICATION OF GAMMA ORYZANOL FROM BY-PRODUCTS OF  
RICE BRAN OIL REFINERY) อ.ที่ปริภษาวิทยานิพนธ์หลัก : รศ. ดร.อาทิวรรณ โชติ  
พฤษย์, 129 หน้า.

วัตถุประสงค์ของการศึกษานี้คือการแยกแกมมาออริซานอลออกจากไขสบู่และน้ำมันกรด  
ซึ่งเป็นผลพลอยได้จากการสกัดน้ำมันจากรำข้าว และการทำบริสุทธิ์สารแกมมาออริซานอลที่ได้  
ด้วยวิธีการโครมาโทกราฟีแบบเฟสปกติ เพื่อที่จะขจัดสารเจือปนหลักซึ่งก็คือกลีเซอไรด์ ไขสบู่ถูกทำ  
ปฏิกิริยาสะปอนนิฟิเคชันกับโซเดียมไฮดรอกไซด์ในเมทานอล และน้ำมันกรดถูกนำมาทำปฏิกิริยา  
ไฮโดรไลซิสด้วยสารละลายโซเดียมไฮดรอกไซด์ ก่อนสกัดด้วยเอทิลอะซิเตต เมื่อผ่านการทำ  
ปฏิกิริยาสะปอนนิฟิเคชันของไขสบู่และปฏิกิริยาไฮโดรไลซิสของน้ำมันกรด ปริมาณของกลีเซอ  
ไรด์จะลดลงจำนวนมาก อย่างไรก็ตาม จากการศึกษา พบว่ามีการสูญเสียของแกมมาออริซานอล  
โดยเฉพาะอย่างยิ่งในกรณีออริซานอลจากไขสบู่ ซึ่งมีการสูญเสียสูงถึง 41% (จาก 6.73% เป็น  
4.07%) ดังนั้นสารสกัดน้ำมันกรดที่ผ่านกระบวนการไฮโดรไลซิสที่มีปริมาณแกมมาออริซานอล  
5.38% จึงถูกเลือกเป็นวัตถุดิบที่เหมาะสมสำหรับการศึกษาการทำบริสุทธิ์แกมมาออริซานอลด้วยวิธี  
โครมาโทกราฟี การทำให้บริสุทธิ์เริ่มต้นด้วยการเลือกวัฏภาคเคลื่อนที่ที่เหมาะสมโดยการใช้โคร  
มาโทกราฟีแบบผ่านบาง ซึ่งพบว่าสารผสมระหว่างเฮกเซนและเอทิลอะซิเตตในสัดส่วน 75:25 โดย  
ปริมาตรเป็นวัฏภาคเคลื่อนที่ที่เหมาะสมที่สุด สารผสมในอัตราส่วนดังกล่าวจึงถูกนำมาใช้ใน  
การศึกษาการทำบริสุทธิ์สารแกมมาออริซานอลด้วยโครมาโทกราฟีในระดับห้องปฏิบัติการซึ่ง  
ดำเนินการกับวัฏภาคเคลื่อนที่ที่มีอัตราส่วนคงที่ โดยทำการศึกษาผลของปริมาณ (5 กรัม, 10 กรัม  
และ 15 กรัม) และขนาดอนุภาคของซิลิกาเจล (15-25 ไมโครเมตร, 25-40 ไมโครเมตร และขนาด  
40-63 ไมโครเมตร) ที่มีต่อประสิทธิภาพของคอลัมน์ ผลการทดลองชี้ให้เห็นว่าคอลัมน์ที่บรรจุด้วย  
ซิลิกาเจลที่มีขนาด 25-40 ไมโครเมตร ปริมาณ 10 กรัม ให้ผลได้และความบริสุทธิ์ของความ  
บริสุทธิ์ของแกมมาออริซานอลสูงที่สุด (83.64%) ซึ่งคิดจากความบริสุทธิ์ของแกมมาออริซานอล  
(>95% ) โดยสามารถปรับปรุงผลได้และความบริสุทธิ์ของผลผลิตขั้นนี้ให้สูงขึ้นได้ถึง 90.15%  
และ 100% ตามลำดับโดยการประยุกต์ใช้โครมาโทกราฟีกับวัฏภาคเคลื่อนที่ที่มีอัตราส่วนไม่คงที่  
ภาควิชา..... วิศวกรรมเคมี..... ลายมือชื่อนิสิต.....  
สาขาวิชา..... วิศวกรรมเคมี..... ลายมือชื่อ อ.ที่ปริภษาวิทยานิพนธ์หลัก.....  
ปีการศึกษา..... 2556.....

## 5470465421: MAJOR CHEMICAL ENGINEERING

KEYWORDS: GAMMA ORYZANOL / SOAPSTOCK / ACID OIL / RICE BRAN OIL / CHROMATOGRAPHY

ANCHANA ANJINTA: CHROMATOGRAPHIC PURIFICATION OF GAMMA ORYZANOL FROM BY-PRODUCTS OF RICE BRAN OIL REFINERY. ADVISOR: ASSOC. PROF. ARTIWAN SHOTIPRUK, Ph.D., 129 pp.

The objective of this study is to separate and purify  $\gamma$ -oryzanol from the extract of saponified soapstock or the extract of hydrolyzed acid oil, by-products from rice bran oil processing, using normal phase chromatography. To remove the main impurity which is glycerides, soapstock was saponified with NaOH in methanol, and acid oil was hydrolyzed with aqueous solution of NaOH, prior to extraction with ethyl acetate. Upon saponification of soapstock and hydrolysis of acid oil, glycerides contents are much reduced, however loss of  $\gamma$ -oryzanol was also observed, particularly in the case of soapstock in which as high as 41% loss of  $\gamma$ -oryzanol (from 6.73% to 4.07%) was resulted. Thus the extract of hydrolyzed acid oil which has higher  $\gamma$ -oryzanol content of 5.38 %wt was selected as a suitable raw material for  $\gamma$ -oryzanol recovery. Chromatography was employed as a purification process and it began with determining the suitable composition of mobile phase by thin layer chromatography (TLC), in which hexane and ethyl acetate mixture at 75:25 v/v was found to be most suitable. This solvent system was employed in a semi-preparative chromatography operated with isocratic mode, in which the effects of the amounts (5 g, 10 g, and 15 g) and particle sizes of silica gel (15-25  $\mu\text{m}$ , 25-40  $\mu\text{m}$  and 40-63  $\mu\text{m}$ ) on the column performance were determined. The result suggested that the column packed with 10 g silica gel of 25-40  $\mu\text{m}$  particle size gave the highest yield (83.64%) of high purity  $\gamma$ -oryzanol (>95%). The yield and purity of the resulted product could be further improved to 90.15% and 100%, respectively, by applying gradient elution mode, in which 85:15 v/v of hexane and ethyl acetate mixture was used as a mobile phase in the first hour before it was switch to 75:25 v/v of hexane and ethyl acetate.

Department : Chemical Engineering Student's Signature .....

Field of Study : Chemical Engineering Advisor's Signature .....

Academic Year : 2013 .....

## ACKNOWLEDGEMENTS

This project would not have been possible without direct and indirect assistance from many people. Foremost, I would like to express his gratitude to the thesis advisor, Assoc. Prof. Dr. Artiwan Shotipruk for all technical support, invaluable guidance and encouragement. In addition, appreciation is also extended to all the committee members, Assoc. Prof. Dr. Muenduen Phisalaphong, Asst. Prof. Dr. Kasidit Nootong and Dr. Duangkamol Ruen-ngam, for their support and helpful recommendations.

Also, my sincere thanks are also given to Thai Edible Oil Co., Ltd for supporting raw materials (rice bran oil soapstock and acid oil) used in this project. Lastly, this project would not have been completed without lots of support from my family and friends.

# CONTENTS

	<b>Page</b>
<b>ABSTRACT IN THAI.....</b>	<b>iv</b>
<b>ABSTRACT IN ENGLISH.....</b>	<b>v</b>
<b>ACKNOWLEDGEMENTS .....</b>	<b>vi</b>
<b>LIST OF FIGURES .....</b>	<b>xii</b>
<b>CHAPTER I INTRODUCTION .....</b>	<b>1</b>
1.1 Motivation .....	1
1.2 Objectives .....	4
1.3 Working scopes .....	4
1.4 Expected benefits .....	5
<b>CHAPTER II BACKGROUND &amp; LITERATURE REVIEWS.....</b>	<b>6</b>
2.1 $\gamma$ -oryzanol.....	6
2.1.1 Structure of $\gamma$ -oryzanol.....	7
2.1.2 Properties of $\gamma$ -oryzanol .....	8
2.1.3 Benefits of $\gamma$ -oryzanol .....	9
2.1.4 Applications of $\gamma$ -oryzanol .....	9
2.2 Rice bran.....	10
2.3 Extracting and refining of rice bran oil .....	11
2.4 Rice bran oil soapstock.....	16
2.4.1 Composition of rice bran oil soapstock.....	16
2.4.2 Impurities in rice bran oil soapstock .....	17
2.5 Acid oil .....	20
2.5.1 Composition of acid oil.....	21
2.6 Chromatography.....	23

	<b>Page</b>
2.7 Literature reviews.....	30
2.7.1 Separation and purification of $\gamma$ -oryzanol from rice bran and crude rice bran oil.....	30
2.7.2 Separation and purification of $\gamma$ -oryzanol from rice bran oil soapstock and acid oil .....	32
<b>CHAPTER III MATERIALS &amp; METHODS .....</b>	<b>42</b>
3.1 Recovery of $\gamma$ -oryzanol from Soapstock.....	43
3.1.1 Characterization of soapstock .....	43
3.1.1.1 pH .....	43
3.1.1.2 Moisture content.....	43
3.1.1.3 Content of $\gamma$ -oryzanol and other components in soapstock .....	44
3.1.2 Separation of $\gamma$ -oryzanol from soapstock.....	44
3.1.2.1 Saponification and dehydration.....	44
3.1.2.2 Extraction (Leaching).....	44
3.2 Acid oil.....	45
3.2.1 Characterization of acid oil .....	45
3.2.1.1 pH.....	45
3.2.1.2 Content of $\gamma$ -oryzanol and other components in acid oil .....	45
3.2.2 Separation of $\gamma$ -oryzanol from acid oil.....	46
3.2.2.1 Hydrolysis of acid oil .....	46
3.2.2.2 Liquid-liquid extraction.....	46
3.3 Thin-layer chromatography.....	47
3.4 Semi-preparative column chromatography .....	47
3.5 Analysis of $\gamma$ -oryzanol.....	48



	<b>Page</b>
<b>CHAPTER IV RESULTS &amp; DISCUSSION .....</b>	<b>49</b>
4.1 Properties of soapstock and acid oil .....	49
4.2 Extraction of saponified soapstock and extraction of hydrolyzed acid oil .....	53
4.3 Thin-layer chromatography (TLC).....	56
4.4 Semi-preparative column chromatography .....	58
4.4.1 Effect of the amount of silica gel packed in a semi-preparative column chromatography on %yield and %purity of $\gamma$ -oryzanol .....	60
4.4.2 Effect of the particle size of silica gel packed in a semi- preparative column chromatography on %yield and %purity of $\gamma$ - oryzanol .....	63
4.4.3 Effect of elution mode between isocratic elution mode and gradient elution mode on %yield and %purity of $\gamma$ -oryzanol .....	66
<b>CHAPTER V CONCLUSIONS &amp; RECOMMENDATIONS .....</b>	<b>69</b>
5.1 Conclusions .....	69
5.2 Recommendations .....	70
<b>REFERENCES.....</b>	<b>72</b>
<b>APPENDIX A EXPERIMENTAL DATA FOR ANALYSIS .....</b>	<b>79</b>
A-1 Standard calibration curve of $\gamma$ -oryzanol HPLC analysis .....	79
A-3 Standard calibration curve of fatty acid HPLC analysis .....	82
<b>APPENDIX B ..EXPERIMENTAL DATA OF PROPERTIES OF SOAPSTOCK AND ACID OIL .....</b>	<b>84</b>
B-1 Moisture content of soapstock.....	84
<b>APPENDIX C CONTENT CALCULATION .....</b>	<b>85</b>
C-1 $\gamma$ -oryzanol content in soapstock extract .....	85
C-2 Glycerides content in soapstock extract .....	85

	<b>Page</b>
C-3 Fatty acid content in soapstock extract.....	86
C-4 $\gamma$ -oryzanol content in the extract of saponified soapstock extract.....	86
C-5 Glycerides content in the extract of saponified soapstock extract .....	87
C-6 Fatty acid content in the extract of saponified soapstock extract.....	88
C-7 $\gamma$ -oryzanol loss in saponification step .....	88
C-8 $\gamma$ -oryzanol content in acid oil extract .....	89
C-9 Glycerides content in acid oil extract.....	90
C-10 Fatty acid content in acid oil extract .....	91
C-11 $\gamma$ -oryzanol content in the extract of hydrolyzed acid oil extract .....	92
C-12 Glycerides content in the extract of hydrolyzed acid oil extract .....	93
C-13 Fatty acid content in the extract of hydrolyzed acid oil extract .....	95
C-14 $\gamma$ -oryzanol loss in hydrolysis step .....	96
 <b>APPENDIX D EXPERIMENTAL DATA FOR CHROMATOGRAPHY</b>	
<b>COLUMN .....</b>	<b>97</b>
D-1 Calculation of %yield, %recovery and %purity of $\gamma$ -oryzanol .....	97
D-2 Example calculation of %recovery and %yield of $\gamma$ -oryzanol.....	97
D-3 Experimental data for column chromatography.....	99
D-4 Example calculation of retention time in a semi-preparative column chromatography.....	100
D-5 Example calculation of plate number and column efficiency in preparative column chromatography.....	112
D-6 Calculation of resolution .....	114
D-7 Chromatogram of the fractions from column chromatography .....	115
 <b>APPENDIX E THE ANALYSIS OF <math>\gamma</math>-ORYZANOL BY USING LIQUID CHROMATOGRAPHY-MASS SPECTROMETRY (LC-MS) .....</b>	
E-1 The analysis of $\gamma$ -oryzanol by using LC-MS.....	117

	<b>Page</b>
<b>VITA .....</b>	<b>129</b>

## LIST OF TABLES

	<b>Page</b>
<b>Table 2.1</b> Composition of crude rice bran oil (Ghosh, 2007) .....	11
<b>Table 2.2</b> Composition of soapstock (Narayan et al., 2006) .....	16
<b>Table 2.3</b> Composition of unsaponified matter (Akiya, 1962) .....	17
<b>Table 2.4</b> Composition of acid oil (Thai Edible Oil Co., Ltd.) .....	21
<b>Table 2.5</b> Composition of FFA in acid oil .....	22
<b>Table 2.6</b> Classification of chromatography (www.chemistry.sc.chula.ac.th) .....	23
<b>Table 4.1</b> Properties of soapstock .....	50
<b>Table 4.2</b> Properties of acid oil .....	52
<b>Table 4.3</b> Comparison of each component in both saponified soapstock extract and hydrolyzed acid oil extract based on dry basis .....	55
<b>Table 4.4</b> The results at different amounts of silica gel packed .....	60
<b>Table 4.5</b> Summary different particle sizes of silica gel packed .....	63
<b>Table 4.6</b> The summary of data experiment at two elution modes: isocratic and gradient elution mode .....	67
<b>Table A-1</b> Standard calibration curve of $\gamma$ -oryzanol HPLC analysis .....	79
<b>Table A-2</b> Standard calibration curve of glycerides HPLC analysis .....	80
<b>Table A-3</b> Standard calibration curve of fatty acid HPLC analysis .....	82
<b>Table B-1</b> Moisture content data of soapstock .....	84
<b>Table D-2.1</b> Experimental data of $\gamma$ -oryzanol from chromatography experiment .....	98
<b>Table D-3.1</b> Percent recovery and yield of $\gamma$ -oryzanol from column chromatography at various the amount of silica gel packed .....	99
<b>Table D-3.2</b> Percent recovery and yield of $\gamma$ -oryzanol from column chromatography at various the size of silica gel packed .....	99
<b>Table D-3.3</b> Percent recovery and yield of $\gamma$ -oryzanol from column chromatography two elution modes .....	100
<b>Table D-4.1</b> Experiment results of column with silica gel 5 g and 25-40 $\mu$ m ( $\gamma$ -oryzanol) .....	103
<b>Table D-4.2</b> Experiment results of column with silica gel 10 g and 25-40 $\mu$ m ( $\gamma$ -oryzanol) .....	104

	<b>Page</b>
<b>Table D-4.3</b> Experiment results of column with silica gel 15 g and 25-40 $\mu\text{m}$ ( $\gamma$ -oryzanol) .....	105
<b>Table D-4.4</b> Experiment results of column with silica gel 15-25 $\mu\text{m}$ and 10 g ( $\gamma$ -oryzanol) .....	106
<b>Table D-4.5</b> Experiment results of column with silica gel 40-63 $\mu\text{m}$ and 10 g ( $\gamma$ -oryzanol) .....	107
<b>Table D-4.6</b> Experiment results of column with silica gel 10 g and 25-40 $\mu\text{m}$ eluting with gradient elution ( $\gamma$ -oryzanol) .....	108
<b>Table D-4.7</b> Experiment results of column with silica gel 5 g and 25-40 $\mu\text{m}$ (Glycerides).....	109
<b>Table D-4.8</b> Experiment results of column with silica gel 10 g and 25-40 $\mu\text{m}$ (Glycerides).....	110
<b>Table D-4.9</b> Experiment results of column with silica gel 15 g and 25-40 $\mu\text{m}$ (Glycerides).....	110
<b>Table D-4.10</b> Experiment results of column with silica gel 15-25 $\mu\text{m}$ and 10 g (Glycerides).....	111
<b>Table D-4.11</b> Experiment results of column with silica gel 40-63 $\mu\text{m}$ and 10 g (Glycerides).....	111
<b>Table D-4.12</b> Experiment results of column with silica gel 10 g and 25-40 $\mu\text{m}$ eluting with gradient elution (Glycerides) .....	112
<b>Table D-5.1</b> Plate number and HETP.....	114
<b>Table D-6.1</b> The chromatographic resolution .....	115
<b>Table E-1.1</b> The summary of molecular weight of each component .....	125

## LIST OF FIGURES

	<b>Page</b>
<b>Figure 2.1</b> Structures of individual components of $\gamma$ -oryzanol (Xu and Godber, 1999) .....	8
<b>Figure 2.2</b> Chemical refining process and physical refining process (Kittiruangthong, 2005) .....	13
<b>Figure 2.3</b> Type of column chromatography .....	24
<b>Figure 2.4</b> Determination of symmetric peak .....	26
<b>Figure 2.5</b> Determination of asymmetric peak.....	27
<b>Figure 2.6</b> Relationship between HETP and interstitial velocity.....	28
<b>Figure 2.7</b> Seetharamajah et al.'s process .....	34
<b>Figure 2.8</b> Rao et al.'s process .....	35
<b>Figure 2.9</b> Indira et al.'s process .....	36
<b>Figure 2.10</b> Narayan et al.'s process .....	37
<b>Figure 2.11</b> Kaewboonnum's process .....	39
<b>Figure 3.1</b> Process for separation and purification of $\gamma$ -oryzanol from by-products of rice bran oil process .....	43
<b>Figure 4.1</b> Soapstock sample .....	49
<b>Figure 4.2</b> Chromatogram of dehydrated soapstock extract .....	51
<b>Figure 4.3</b> Acid oil sample.....	51
<b>Figure 4.4</b> Chromatogram of acid oil extract.....	53
<b>Figure 4.5</b> Chromatogram of the extract of saponified soapstock .....	54
<b>Figure 4.6</b> Chromatogram of the extract of hydrolyzed acid oil.....	55
<b>Figure 4.7</b> The TLC plates of 1. Hydrolyzed acid oil extract, 2. $\gamma$ -oryzanol standard, 3. Fatty acid standard (oleic acid) and 4. Glycerides standard (rice bran oil) at with various compositions of the hexane and ethyl acetate mixture.....	57
<b>Figure 4.8</b> The behavior of three major components in hydrolyzed acid oil extract by using isocratic elution mode (Hexane to ethyl acetate 75:25 v/v).....	59
<b>Figure 4.9</b> The amount of components sample at various amount of silica gel packed by using isocratic elution mode .....	62

	<b>Page</b>
<b>Figure 4.10</b> The amount of components sample at different particle size of silica gel packed by using isocratic elution mode .....	66
<b>Figure 4.11</b> The behavior of three major components at different elution mode .....	68
<b>Figure A-1.1</b> Standard calibration curve of $\gamma$ -oryzanol standard analyzed by HPLC	79
<b>Figure A-1.2</b> Chromatogram of $\gamma$ -oryzanol standard.....	80
<b>Figure A-2.1</b> Standard calibration curve of glycerides standard analyzed by HPLC.	81
<b>Figure A-2.2</b> Chromatogram of glycerides standard .....	81
<b>Figure A-3.1</b> Standard calibration curve of fatty acid standard analyzed by HPLC ..	82
<b>Figure A-3.2</b> Chromatogram of fatty acid standard.....	83
<b>Figure D-4.1</b> asymmetric peak.....	101
<b>Figure D-4.2</b> The peak chromatogram of $\gamma$ -oryzanol .....	101
<b>Figure D-7.1</b> Chromatogram of the fraction (pure $\gamma$ -oryzanol) analyzed by RP-HPLC detect with ELSD detector .....	115
<b>Figure D-7.2</b> Chromatogram of the fraction (pure glycerides) analyzed by RP-HPLC detect with ELSD detector. ....	116
<b>Figure D-7.3</b> Chromatogram of the fraction (pure fatty acid) analyzed by RP-HPLC detect with ELSD detector .....	116
<b>Figure E-1.1</b> The RP-HPLC of standard $\gamma$ -oryzanol analyzed by RP-HPLC equipped with ELSD detector.....	117
<b>Figure E-1.2</b> The RP-HPLC chromatogram of collected fraction from the semi-preparative column chromatography .....	118
<b>Figure E-1.3</b> The RP-HPLC chromatogram of standard $\gamma$ -oryzanol analyzed by RP-HPLC equipped with diode array detector (320 nm).....	119
<b>Figure E-1.4</b> The RP-HPLC chromatogram of standard $\gamma$ -oryzanol in mobile phase: methanol/acetonitrile/dichloromethane/acetic acid (50:44:3:3) by using UV detector at 330 nm (Huang C. J., 2003).....	120
<b>Figure E-1.5</b> The RP-HPLC chromatogram of standard $\gamma$ -oryzanol analyzed at 314 nm of diode array detector (Kumar R. R. et al., 2007) .....	121
<b>Figure E-1.6</b> The RP-HPLC chromatogram of standard $\gamma$ -oryzanol analyzed by diode array detector at 325 nm (Pascual et al., 2011).....	122
<b>Figure E-1.7</b> The results of standard $\gamma$ -oryzanol analyzed by mass spectrometry ...	124

	<b>Page</b>
<b>Figure E-1.8</b> The RP-HPLC chromatogram of the collected fraction of $\gamma$ -oryzanol analyzed diode array detector at 320 nm .....	126
<b>Figure E-1.9</b> The results from the collected fraction analyzed by mass spectrometry.....	127



# CHAPTER I

## INTRODUCTION

### 1.1 Motivation

Being a major diet for Thai people, rice is one of the crops grown widely almost in every part of the country. Annual amount of domestic rice production is approximately 30-35 million tons. About one third of this amount is exported and the rice export contributes to the highest value in the agricultural section ([www.oae.go.th](http://www.oae.go.th)).

Milling process is a method of producing white rice and brown rice consumed by human, leaving rice bran as a major by-product (Sereewatthanawut et al., 2008). There are several benefits of rice bran, for example, it is used as animal feed or is extracted for oil. Oil content in rice bran is approximately 12 to 25 wt%, and about 95-98% of the oil can be extracted and processed further to obtain rice bran oil (Pillaiyar, 1980). Rice bran oil contains a number of active compounds, and it therefore has been used in functional foods, pharmaceutical products and cosmetics (Amarasinghe and gangogavilage, 2004). Some important nutraceutical substances in edible rice bran oil are, for instance, vitamin E and  $\gamma$ -oryzanol. Of particular interest in this study,  $\gamma$ -oryzanol, which exists only in rice bran oil, is a group of compounds, each of which comprises ferulic acid of sterol or triterpene alcohol (Kittiruangthong, 2005). Several health benefits of  $\gamma$ -oryzanol include reduction of cholesterol level in blood (Yoshino et al., 1989), platelet aggregation (Seetharamaiah et al., 1990) and antioxidative action (Huang et al., 2002).

In general, rice bran oil refining can be carried out by a chemical or a physical process, but in the current rice bran oil refining, chemical process is commonly used. In a typical chemical refining, free fatty acid content in crude oil was removed by alkali treatment. This process caused more than 90 wt% of initial  $\gamma$ -oryzanol in crude oil to be lost into soapstock, the main by-product of the alkali treatment (Jesus et al., 2010). Sometimes, to extend the storage life of soapstock, sulfuric acid is added to convert the soap back to fatty acids and salt. When water and the soluble salt are

removed, the remaining water insoluble fraction is acid oil. Both soapstock and acid oil contains a large amount of  $\gamma$ -oryzanol and are therefore interesting raw materials for commercial production  $\gamma$ -oryzanol.

Extraction of  $\gamma$ -oryzanol from soapstock requires several pretreatment steps, starting with a process called saponification, in which soapstock was saponified with alkaline to remove the remaining glycerides. The saponified product was then dehydrated, and the resulting dehydrated saponified soapstock was extracted with ethyl acetate. For acid oil, however, since water has previously been removed, only one pretreatment step is needed to remove the remaining glycerides prior to extraction of  $\gamma$ -oryzanol. Specifically, acid oil needs to be hydrolyzed with sodium hydroxide. The hydrolyzed acid oil could then be directly extracted with ethyl acetate.

To obtain pure  $\gamma$ -oryzanol, further purification step would be required for both the extracts of saponified soapstock and hydrolyzed acid oil. Kaewboonnum (2007) conducted a study on the purification of  $\gamma$ -oryzanol from the saponified soapstock extract, employing two crystallization steps using 20 % v/v of ethyl acetate mixture in methanol as a solvent. The process gave the yield and  $\gamma$ -oryzanol purity of 74.6% and 55.17%, respectively.

Chromatography is another separation technique employed for purification of natural compounds. Rao et al. (2002) applied crystallization with normal phase column chromatography to improve the purity of  $\gamma$ -oryzanol extracted from saponified soapstock. The extract was first crystallized using methanol and ethyl acetate as a solvent in order to remove certain impurities. The column chromatography using chloroform as an eluent was then used to obtain  $\gamma$ -oryzanol rich fraction. This fraction was purified further through a recrystallization step in an organic solvent using methanol and acetone as a solvent to obtain approximately 90% pure  $\gamma$ -oryzanol.

Despite the ease of handling acid oil and the long storage life compared with soapstock, reports on the purification of  $\gamma$ -oryzanol from hydrolyzed acid oil are still scarce. Most literatures on purification of  $\gamma$ -oryzanol mostly involve the recovery of the compounds either from soapstock or from crude rice bran oil. Despite this, these existing literatures might still give some insight into the development of the purification process for  $\gamma$ -oryzanol starting from acid oil. Similar to soapstock, the

recovery of  $\gamma$ -oryzanol from crude rice bran oil also involves extraction, crystallization and/or chromatography processes. Zullaikah (2009) used two crystallization steps in order to obtain higher purity of  $\gamma$ -oryzanol from crude rice bran oil. A mixture of acetone and methanol was used as solvent in the first step but hexane was used instead for the second step. This resulted in about 59% recovery and 93-95% purity of  $\gamma$ -oryzanol crystals. Beside crystallization, purification of  $\gamma$ -oryzanol from rice bran oil extract by chromatography has also been investigated (Lai et al., 2005). In their study, the normal phase column chromatography with step gradient elution mode was employed. A mixture of hexane and ethyl acetate (85:15 v/v) was used in the first elution, followed by hexane/ethyl acetate (50:50 v/v) and pure ethyl acetate, respectively. By this procedure, 90% recovery of purified  $\gamma$ -oryzanol (90-98% purity), could be achieved. For acid oil, Das et al. (1999) proposed method for separating and purifying  $\gamma$ -oryzanol from crude dark acid oil by combining column chromatography and crystallization methods. Due to high free fatty acid in crude dark acid oil, the process began with distillation of crude dark acid oil under high vacuum in order to reduce the free fatty acid content from 50-60% in original acid oil to only 10% in the residue oil that was remained after distillation. The remaining acid oil was then hydrolyzed with NaOH to remove glycerides by converting them to fatty acids. The hydrolyzed acid oil was then separated from the reaction mixture and was added with aqueous solution  $\text{CaCl}_2$  solution form  $\gamma$ -oryzanol containing precipitate. The precipitate was air dried, and then extracted with ethyl acetate. The extract was then washed with alkali and water, followed by drying over anhydrous sodium sulfate. The ethyl acetate was evaporated, and purification of  $\gamma$ -oryzanol was then carried out further by column chromatography packed with silica gel using chloroform as an eluent. Fractions were collected and after the removal of chloroform, the residue was further purified by activated charcoal treatment in hot methanol solution. The residue white  $\gamma$ -oryzanol crystals were found to have approximately 85% purity and the recovery was in the range between 54 to 86%.

Based on the evaluation of previous research conducted on  $\gamma$ -oryzanol purification, chromatography in comparison with crystallization resulted in  $\gamma$ -oryzanol with higher yield and purity. In this study, we propose therefore to apply the chromatographic process for the purification of  $\gamma$ -oryzanol from the byproducts of

rice bran oil industry. Initially, the suitability of saponified soapstock and hydrolyzed acid oil as a raw material for recovery of  $\gamma$ -oryzanol was evaluated based on the ease of extraction process, the content  $\gamma$ -oryzanol and percent  $\gamma$ -oryzanol loss during the glycerides removal step. The more suitable raw materials were further purified by chromatography, in which the effects of various process variables were determined on the yield and purity of resulting  $\gamma$ -oryzanol product.

## 1.2 Objectives

To develop a procedure for purifying  $\gamma$ -oryzanol from extracted saponified soapstock or extracted hydrolyzed acid oil using normal phase chromatography and investigate the effects of operating variables on the yield and purity of  $\gamma$ -oryzanol obtained.

## 1.3 Working scopes

1.3.1 Ethyl acetate extraction of  $\gamma$ -oryzanol will be carried out from saponified soapstock and extracted hydrolyzed acid oil following the methods reported in literature. Based on the ease of extraction procedure, the analysis of  $\gamma$ -oryzanol content, as well as percent loss of  $\gamma$ -oryzanol in removing glycerides step, one of the raw materials will be chosen for further chromatographic purification experiments.

1.3.2 Determine the suitable mobile phase mixtures of the extract from 1.3.1 (saponified soapstock or hydrolyzed acid oil) at various compositions of hexane and ethyl acetate which are 95:5, 90:10, 85:15, 80:20, 75:25, 70:30, 65:35, 60:40, 55:45 and 50:50 v/v using thin-layer chromatography plates coated with silica gel.

1.3.3 Using the suitable mobile phase determined in 1.3.2 and silica gel of selected size as a stationary phase, determine the effect of the amount of silica gel (5 g, 10 g and 15 g) packed in a chromatography column on the yield and purity of  $\gamma$ -oryzanol in the effluent fraction.

1.3.4 In a normal phase chromatographic column packed with selected amount of silica gel, determine the effect of the particle size of the silica gel packing (15-25

$\mu\text{m}$ , 25-40  $\mu\text{m}$  and 40-63  $\mu\text{m}$ ) on yield and purity of  $\gamma$ -oryzanol in the effluent fraction.

1.3.5 In a normal phase column chromatography compare the yield and purity of  $\gamma$ -oryzanol in the effluent fractions obtained with isocratic and gradient elution mode to determine the possibility of further improving the yield and purity of  $\gamma$ -oryzanol.

#### **1.4 Expected benefits**

To determine the suitable conditions and develop a suitable protocol for chromatography purification of  $\gamma$ -oryzanol from by-products of rice bran oil refinery, which would add value to the waste from the industry.

## CHAPTER II

### BACKGROUND & LITERATURE REVIEWS

This chapter is divided into two main parts. The first part summarizes background on rice bran and how to extract and refine rice bran oil. Then in the second part, earlier researches related to separation and purification of  $\gamma$ -oryzanol from rice bran and rice bran oil and by product of the oil refining process are reviewed.

#### Background

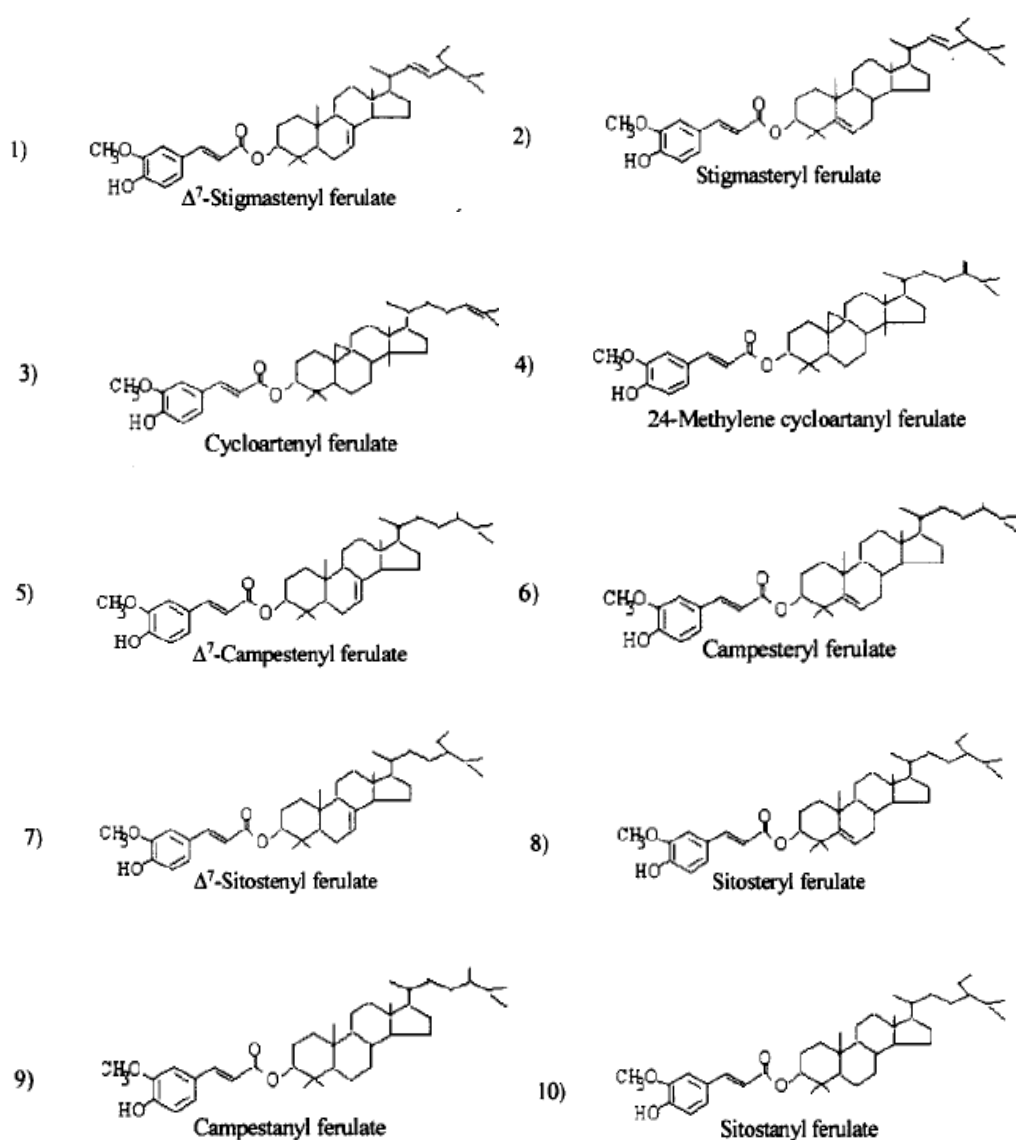
Rice bran is a by-product from milling process which is used as a material for extraction of rice bran oil. There are two methods of rice bran oil refinery: chemical and physical refining. In chemical refining, soapstock is a main by-product containing high amount of  $\gamma$ -oryzanol which has several benefits to human health. Furthermore, step of adding acid into soapstock creates another by-product, namely, acid oil, which also contains  $\gamma$ -oryzanol. In this part, information on processes involved in  $\gamma$ -oryzanol extraction and purification are described.

#### 2.1 $\gamma$ -oryzanol

$\gamma$ -oryzanol was first discovered in rice bran oil by Tsuchiya and Kaneko, in 1954. In the past, researchers thought that  $\gamma$ -oryzanol was a single compound. Subsequent studies however demonstrated that  $\gamma$ -oryzanol is a group of ferulic acid and sterols or triterpene alcohols. Rice bran oil was found to contain 20 times  $\gamma$ -oryzanol as high as vitamin E. That is,  $\gamma$ -oryzanol content in rice bran oil is about 2%, while that of vitamin E is only 0.1%.  $\gamma$ -oryzanol content in rice bran oil however varies, depending on the rice bran oil extraction conditions and the rice bran oil processing conditions (Michael and Gordon, 1998).

### 2.1.1 Structure of $\gamma$ -oryzanol

Found only in rice bran oil,  $\gamma$ -Oryzanol, is a mixture of compounds, each containing two parts. The first more polar part is ferulic acid, and the other less polar part contains a hydroxyl functional group such as sterols and triterpene alcohols, similar to cholesterol. In 1993, Rogers et al. reported five major components found in  $\gamma$ -oryzanol, which were cycloartenyl ferulate, 24-methylene cycloartanyl ferulate, campesteryl ferulate,  $\beta$ -sitosteryl ferulate and cycloartanyl ferulate. Another group of researchers (Xu and Godber, 1999), later identified ten individual components in  $\gamma$ -oryzanol. They were  $\Delta^7$ -stigmasteryl ferulate, stigmasteryl ferulate, cycloartenyl ferulate, 24-methylenecycloartanyl ferulate,  $\Delta^7$ -campestenyl ferulate, campesteryl ferulate,  $\Delta^7$ -sitostenyl ferulate, sitosteryl ferulate, campestanyl ferulate and sitostanyl ferulate, whose chemical structures are shown in Figure 2.1. Three components: cycloartenyl ferulate, 24-methylenecycloartanyl ferulate and campesteryl ferulate are among the major components of  $\gamma$ -oryzanol and typically account for 80 percent of  $\gamma$ -oryzanol (Zhimin et al., 2001).



**Figure 2.1** Structures of individual components of  $\gamma$ -oryzanol (Xu and Godber, 1999)

### 2.1.2 Properties of $\gamma$ -oryzanol

$\gamma$ -oryzanol ( $C_{40}H_{58}O_4$ ) is a white or slightly yellow crystalline powder (Tamagawa et al., 1992). It cannot dissolve in water and polar solvents such as chloroform, ether and methanol (Narayan et al., 2006). It can dissolve in low polar solvent such as acetone, isopropanol and ethyl acetate or in non polar solvents such as hexane and heptane.  $\gamma$ -oryzanol has a melting point of 137.5-138.5 °C and absorption maxima were found at 315, 291 and 231 nm (Kaneko et al., 1954).



### 2.1.3 Benefits of $\gamma$ -oryzanol

$\gamma$ -oryzanol is a characteristic compound found only in rice bran oil and not in other vegetable oils, which exhibits several health benefits to human.  $\gamma$ -oryzanol found in rice bran oil has antioxidant activity that is six times that of vitamin E (Huang et al., 2002). The highest antioxidant activity was found for 24-methylenecycloartanyl ferulate.  $\gamma$ -oryzanol can increase a level of good lipid (HDL) to the body. This type of fat helps remove bad lipid (LDL) and triglycerides in blood vessels. These can reduce the constricted blood vessels and increase the blood circulation. It was also shown to reduce stress to the vital organs such as the liver, kidney, heart, brain, pancreas, etc.  $\gamma$ -oryzanol can also decrease plasma cholesterol (Yoshino et al., 1989) and platelet aggregation (Seetharamaiah et al., 1990). Other benefits include reduction of disorders of menopause (Murase et al., 1963), treatment of nervous system disorders and the muscle mass improvement (Bonner et al., 1990).

### 2.1.4 Applications of $\gamma$ -oryzanol

Due to many beneficial effects of  $\gamma$ -oryzanol on human health mentioned above,  $\gamma$ -oryzanol has been applied in some products such as cosmetic, pharmaceutical products or used as food additives. Some examples are as follow.

Cosmetic:

$\gamma$ -oryzanol is a substance that can prevent lipid peroxidation caused by exposure to UV light. Therefore, it is used in cosmetic productions such as sunscreen. Ferulic acid and  $\gamma$ -oryzanol are compositions in a cosmetic sunscreen. Moreover, ferulic acid and its ester stimulate hair growth and prevent skin aging.  $\gamma$ -oryzanol emulsions are used as preservatives for cosmetics. It is able to prevent color change of many cosmetic products (Minami and Morito, 1982). Moreover,  $\gamma$ -oryzanol is one of the most common ingredients used in consumer products such as shower products, hair treatments and deodorants. Shower products contain  $\gamma$ -oryzanol about 3-20 % wt.  $\gamma$ -oryzanol as one of the ingredients in shower products can treat atopic dermatitis and senile xeroderma. For hair treatments, 1 wt % of  $\gamma$ -oryzanol added to the product can change gray hair into

natural black hair because it helps stimulate melanin (Nagahara, 1996). Moreover,  $\gamma$ -oryzanol can also be used in nail lacquers and helps prevent nails from discoloration (Hayafune and Sato, 1990).

Pharmaceutical products:

$\gamma$ -oryzanol contained pharmaceutical formulation is used in preventing motion sickness and in the treatment of nervous system disorders (Sakada and Hideharu, 1982). Oryzanol not only has been known for the therapeutic benefits, its safety to use as a drug has been demonstrated. For example, in 1991 Tsushimoto et al., showed that oryzanol is non-genotoxic and non-inhibitory of cellular communication. In some experiments,  $\gamma$ -oryzanol exhibits hypocholesterolemic activity, and thus, when added to a high cholesterol diet, it can significantly inhibit the platelet aggregation in rat (Seetharamajah et al., 1990).  $\gamma$ -oryzanol has been shown to be highly effective against lipogenic liver cirrhosis in spontaneously hypertensive rats (Ito et al., 1992).

Food application:

$\gamma$ -oryzanol are used as food additives in several food products. As an antioxidant, it is usually used as an ingredient in vegetable oils in order to prevent rancid oil.  $\gamma$ -oryzanol is also used as preservatives for food as well as cosmetics. It can prevent color change in foods that look like emulsions (Minami and Morito, 1982). Moreover,  $\gamma$ -oryzanol is always used as supplementary foods and beverages because  $\gamma$ -oryzanol has many benefits to human. When it is taken, it helps skins to be moisturized and can control the systems of lipid under skins.

## **2.2 Rice bran**

Rice is one of the most important foods consumed by half of the world population, especially in Asian countries (Cho J.Y. et al., 2012). In a rice milling process, the rice husk, the rice germ (1-2 %) and the rice bran (8-9 wt % of the rice paddy) are removed from the rice paddy to produce white rice (Peretti et al., 2003). Rice bran is one of the most important by-products from rice milling process. It has

many beneficial nutrients and biological effects (Patel and Naik, 2004). Rice bran consists of many valuable substances such as vitamin E ( $\alpha$ -tocopherol and tocotrienol) and  $\gamma$ -oryzanol. Rice bran was also used in many products such as oil production, cosmetics and skin care, animal feed and food supplements.

### 2.3 Extracting and refining of rice bran oil

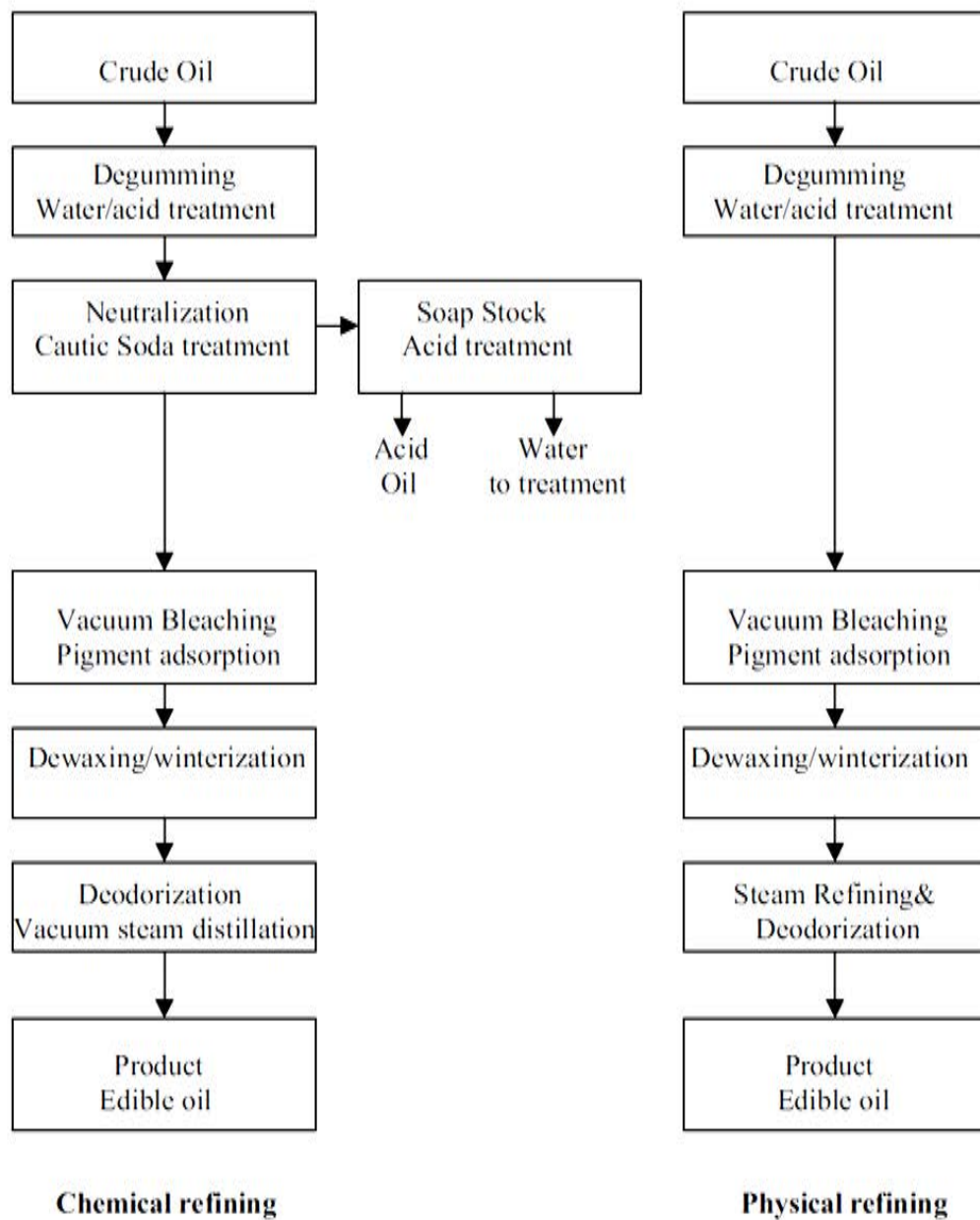
There are two steps for producing rice bran oil. The first step is rice bran oil extracting process that is used for extracting crude rice bran oil from rice bran. Hexane is usually used as a solvent to chemically extract rice bran oil (Johnson and Lusas, 1983). Crude rice bran oil is obtained after removing solvent. It is used as a raw material for rice bran oil refining which is the second step for producing rice bran oil. The composition of crude rice bran oil is shown in Table 2.1.

**Table 2.1** Composition of crude rice bran oil (Ghosh, 2007)

Composition of crude rice bran oil	
Saponifiable lipid	
Triacylglycerols	81-84 %
Diacylglycerols	2-3 %
Monoacylglycerols	1-2 %
Free fatty acids	2-6 %
Waxes	3-4 %
Glycolipids	0.8 %
Phospholipids	1-2 %
Unsaponifiable matters	4 %

In rice bran oil refining process, there are two alternatives are used: physical refining and chemical refining or alkali refining. In physical refining process, free fatty acid in crude rice bran oil is removed by steam in the deodorization step. This process helps keep  $\gamma$ -oryzanol, tocopherol and tocotrienol in rice bran oil. On the contrary in chemical refining process, free fatty acid in crude rice bran oil is removed by adding caustic soda in the neutralization step to convert it to soapstock. In this

process  $\gamma$ -oryzanol, tocopherol and tocotrienol are also removed from rice bran oil along with the soapstock by-product. Rice bran oil produced by chemical refining process therefore has low content of  $\gamma$ -oryzanol, low tocopherol and low tocotrienol. However, chemical refining of crude rice bran oil yields better product in terms of color and cloud point (Arumughan et al., 2003). In addition, due to the simplicity of the process, rice bran oil industries nowadays still use chemical refining of crude rice bran oil. Both chemical refining process and physical refining process differs in some steps as summarized in Figure 2.2 and the details are described as follow.



**Figure 2.2** Chemical refining process and physical refining process (Kittiruangthong, 2005)

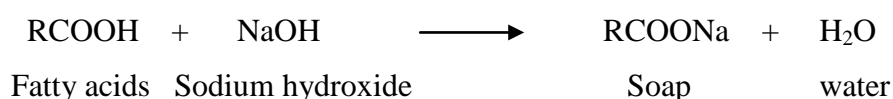
### Degumming

Degumming is the first step of refining process. This step is designed to remove phospholipids (gums). There are two types of gum in crude oil. First is hydratable gums and the other is nonhydratable gums. The hydratable gums which are

soluble in water can separate from rice bran oil using deionized water. The method is called water degumming or acid degumming. The other method for removing hydratable gums is by using surface active agents such as sodium oleate, alkyl aryl sulfonate, alkylated phenol and ethylene oxides. This method can remove much more amount of phosphorus than water or acid degumming (Bhattacharyya et al., 1985). For nonhydratable gums, they are usually removed from rice bran oil by using phosphoric acid, citric acid, malic acid or citric anhydride. This process is called superdegumming. The superdegumming method can convert nonhydratable gums to hydratable gums by mixing the oil with citric acid which has concentration about 80-85% and heating the mixture to 70-80 °C for 15-20 minutes (Ringer et al., 1977). Then, the hydratable gums are crystallized as calcium and magnesium salts, waxes, and glycerol. The other method for removal nonhydratable gums is by enzymatic degumming. For enzymatic degumming, the oil is reacted with enzyme which is phospholipase. This enzyme converts nonhydratable gums into hydratable gums and free fatty acid by hydrolyzing the ester bond of the phospholipase at the surface between oil and water (Buchold, 1993). Then water degumming was used to remove hydratable gums.

#### Neutralization (deacidification)

Neutralization is an important step in chemical refining oil process. The objective of this step is to remove fatty acids and other impurities such as phosphatides, proteinaceous, and mucilaginous substances. Fatty acids are removed by adding alkali into the crude oil, which then converts it to soap, by the following deacidification reaction.



Sodium hydroxide is used as an alkaline in this procedure which can remove fatty acid about 99.97-99.99%. Sodium hydroxide was mixed with the oil. During this step, sodium hydroxide and the oil are heated to 75 °C in order to remove emulsions which occur in this reaction and then leave them for the aqueous phase to settle. The

aqueous phase is known as soapstock which can be removed from the neutral oil by washing with about 90°C of hot water, followed by settling or centrifugation. The oil obtained from this step will be sent to the bleaching and deodorization units. The soapstock by-product from this step is generally used as animal feed (Das et al., 1998). Sometimes, soapstock is reacted with sulfuric acid in order to convert it into free fatty acid, and water is removed. This process results in what is called acid oil. Compared with soapstock, acid oil can be handled more easily and it has extended storage life.

### Bleaching

The aim of the bleaching step is to remove pigments from the oil. Bleaching step is usually done after removing some gums in the degumming step by using adsorbents called bleaching clay, activated clay or activated carbon at about 2 w % of the oil. This step can also help remove other impurities such as soaps, some oxidation product and some remaining gums (Belitz et al., 1987).

### Dewaxing

Dewaxing is a step added in some oil production, in which have a large amount of waxes are found in rice bran oil. The objective of dewaxing process is to remove waxes which are compounds of ester of long chain acid and long chain fatty alcohol. The method for removing waxes is usually done after the bleaching step by cooling the bleached oil to 6-8 °C for 4-6 hours in order to control crystallization of waxes. Filtration was then used to separate crystals of waxes.

### Deodorization

The objective of this process is to remove volatile compounds such as aldehydes and ketones. These compounds cause oil to have unpleasant smell. Therefore, this step is an important for producing good quality oil. In deodorization step, steam is used under a vacuum condition and high temperature, in order to rapidly remove some smell from the oil. This not only removes the smell, but it also helps extend the shelf life as it also removes some free fatty acid and other impurities.

## 2.4 Rice bran oil soapstock

Soapstock is one of the by-products of chemical refining of rice bran oil process in the neutralization step. The main purpose of the neutralization step is to remove free fatty acids and other impurities. During this neutralization step, a large amount of  $\gamma$ -oryzanol is lost from the oil into the soapstock about 83-95% (Krishna et al., 2001). Soapstock is generally used as animal feed (Das et al., 1998).

### 2.4.1 Composition of rice bran oil soapstock

Rice bran oil soapstock consists mainly of water, soap, glycerides and unsaponified matter, 65-70 % wt of which is water. Although the composition of soapstock varies depending on the rice bran oil extraction conditions and the rice bran oil processing conditions, a typical composition of soapstock is shown in Table 2.2.

**Table 2.2** Composition of soapstock (Narayan et al., 2006)

Composition of soapstock	
Water	65-70 % wt
Soap	20-22 % wt
Glycerides (mainly triglycerides)	2-2.5 % wt
Unsaponified matter	7-7.75 % wt

The unsaponification matter in the soapstock as shown in Table 2.2 refers to a mixture of sterols, higher fatty acid alcohols, hydrocarbons and oryzanol, whose composition is summarized in Table 2.3.



**Table 2.3** Composition of unsaponified matter (Akiya, 1962)

Composition of unsaponified matter	
Sterols	42 % wt
Higher fatty acid alcohols	24 % wt
Oryzanol (ferulic acid esters)	20 % wt
Hydrocarbons	10 % wt
Unidentified compounds	2 % wt

#### 2.4.2 Impurities in rice bran oil soapstock

During the rice milling process, the major impurities in rice bran oil consist of free fatty acid, soap (FFA), glycerides, phospholipids, waxes, sterols, glycolipids, resinous matter, tocopherol derivatives and pigment (Narayan et al., 2006). Some of these impurities get into soapstock, and knowing the types of impurities in rice bran oil soapstock is necessary for separation of  $\gamma$ -oryzanol. These impurities are shown as follow:

##### - Soap

Soap is accounted for about 20-22 % wt of the soapstock. It is in the form of sodium salt of free fatty acid in rice bran oil that remains in soapstock. Rice bran oil soapstock can dissolve in a polar solvent such as methanol as well as water but it cannot dissolve in a non polar solvent such as acetone and ethyl acetate. On the contrary,  $\gamma$ -oryzanol is highly soluble in acetone and ethyl acetate but insoluble in methanol and water. The fact that the solubilization behavior of soap differs from that of  $\gamma$ -oryzanol in polar and non polar solvents leads to the basis for separation of  $\gamma$ -oryzanol from soapstock.

##### - Glycerides

Glycerides are glycerol esters of fatty acids contained in soapstock. There are three forms of glycerides in soapstock which are mono-glycerides, di-glycerides and tri-glycerides. Tri-glycerides are mostly found in soapstock. The amounts of tri-glycerides in soapstock depend on process condition in the alkali-refining step. On the

contrary, the other forms of glycerides exist in minor amount depending on the extent of hydrolysis of the oil (Das et al., 1998). Tri-glycerides are soluble in low polar or non polar solvent such as hexane, isopropanol, chloroform and ethyl acetate while mono-glycerides and di-glycerides have lower solubility in these solvent compared with tri-glycerides. Saponification is a suitable technique for removing tri-glycerides from soapstock because saponification can convert tri-glycerides into soaps (Naraya et al., 2006).

- Phospholipids (gums)

Phospholipids (gums) are caused by degumming step because degumming step cannot remove all phospholipids from rice bran oil refining process. Therefore, these impurities can be lost into the neutralization step. The neutralization step produces soapstock as a by-product. Two kinds of gums are found in soapstock, which are hydratable and nonhydratable gums. Nonhydratable phospholipids in particular have an effect on  $\gamma$ -oryzanol separation from soapstock because they have high surface activity (Narayan et al., 2006). Hydratable gums can be removed by water, acid or surface active agents such as sodium oleate, alkyl aryl sulfonates or lauryl sulfate (Bhattacharyya et al., 1985) while nonhydratable gums can be removed by citric acid, phosphoric acid, malic acid or citric anhydride called superdegumming. Nonhydratable gums can be removed by enzyme called enzymatic degumming, which can convert nonhydratable gums into hydratable gums and free fatty acid. The hydratable gums can then be removed by water, acid or surface active agents.

- Waxes

Waxes can reduce oil yields during oil refining process (Gingras, 2000). Waxes consist of two parts which are esters of saturated fatty acid and saturated fatty alcohols (Gingras, 2000). Waxes in rice bran are composed of two classes. The first is soft waxes which have melting point less than 75°C and the other class is hard waxes which have melting point more than 80°C. Waxes are generally removed using gravity settling during the rice bran oil refinery process. However, this dewaxing step was performed after neutralization of the crude oil. Therefore, soapstock still contain

a large amount of wax that may complicate the subsequent purification process for  $\gamma$ -oryzanol.

- Sterols

Sterols are major components of the unsaponified matter in rice bran oil soapstock (Akiya, 1962). There are three major sterols in rice bran oil:  $\beta$ -sitosterol, campesterol, and stigmasterol. Sterols in rice bran oil consist of neutral sterols which are free sterols and steryl esters and polar sterols, which are steryl glycosides and acylated steryl glycosides. During alkali refining, the process conditions such as temperature, pH and time have an effect on the content of each types of sterols in soapstock. A large number of neutral sterols and polar sterols are extracted from the crude oil into the soapstock during alkali refining (Kochhar, 1983). The soluble behavior between neutral sterols and polar sterols can be used for separating neutral sterols from polar sterols.

- Glycolipids

Glycolipids (phosphoglycolipids) are crucial interfering impurities that affect the purification of  $\gamma$ -oryzanol. In the degumming step, these compounds interfere with rice bran oil refining as a result of their very high surface activity, which leads to high oil losses into soapstock during the deacidification step. The method for decreasing amount of glycolipids is enzymatic pretreatment with Lipase G, which has the same hydrolysis function as a phospholipase. This enzyme hydrolyzes glycerides, phospholipid and glycolipids and also reduces the phosphorus level to about 5 ppm (Kaimal et al., 2002).

- Resinous materials

Resinous materials in soapstock originate from polymerization of wax components. The resinous materials can be saponified to triacontanol and soaps. The wax-like components are significant interfering impurities during the purification of  $\gamma$ -oryzanol especially in the chromatography and crystallization process as they strongly adsorb onto the support as well as  $\gamma$ -oryzanol. These impurities also interfere with  $\gamma$ -oryzanol purification by disrupting crystal growth. During crystallization of  $\gamma$ -

oryzanol from the unsaponified matters of soapstock, the wax-like (mucilaginous) impurities precipitate out first when decreasing the temperature of solvent miscella from 60–70 °C to 25–30 °C. At this temperature (25–30°C),  $\gamma$ -oryzanol also crystallizes, thus making the separation of wax and  $\gamma$ -oryzanol difficult. Therefore, the separation of supernatant miscella from mucilaginous impurities should be considered carefully.

- Tocopherol derivatives

The impurities which get into soapstock include tocopherol derivatives such as tocopherols and tocotrienols or vitamin E. They are a family of compounds possessing a hydroxychromane ring and a terpenoid side chain. These components have been separated from  $\gamma$ -oryzanol by normal-phase chromatography and reversed-phase chromatography.

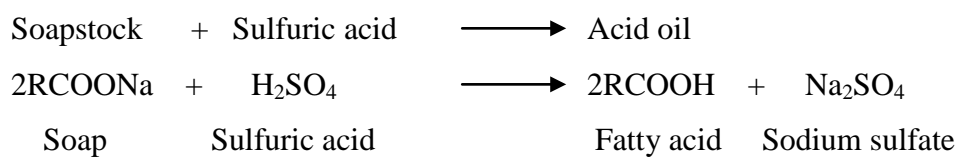
- Pigments

Pigments found in rice bran oil are chlorophyll, carotenoids (lutein, xanthophylls), and protein degradation products (Kuroda et al., 1977). Chlorophylls are found in crude rice bran oil in high concentration. The content of peptides in rice bran oil varies depending on the degree of heating during stabilization of the rice bran (Gingras, 2000). The common method for removing these pigments from crude rice bran oil is by bleaching using adsorbents such as activated clay (Guhe et al., 1998).

## **2.5 Acid oil**

Acid oil is one of the by-products of chemical refining of rice bran oil process in the neutralization step. It originates from soapstock which was reacted with sulfuric acid through a reaction called acidulation shown below (Kittiruangthong, 2005). Acid oil is viscous liquid similar to oil, having brown or black color and cannot be dissolved in water. It has lower moisture at a maximum of 2.0 %. It also can be easily handled and has extended storage life (Thai Edible Oil Co., Ltd.).

Acidulation (Kittiruangthong, 2005)



### 2.5.1 Composition of acid oil

Acid oil has similar components as soapstock because both acid oil and soapstock are both by-products in rice bran oil refining process. Free fatty acid is a major component found in acid oil which accounts for about 42.75-57.5 % wt. The amount of each component in the acid oil depends on the acidulation process. The composition of acid oil is shown in Table 2.4.

**Table 2.4** Composition of acid oil (Thai Edible Oil Co., Ltd.)

Composition of acid oil	
% FFA	45
% $\gamma$ -oryzanol	6-7
%Natural oil+Others	46.5
%Moisture content	1.5

**Table 2.5** Composition of FFA in acid oil

<b>Fatty acid composition</b>	<b>Common name</b>	<b>Amount of fatty acid (%)</b>
C14:0	Myristic acid	0.56
C16:0	Palmitic acid	21.58
C17:0	Margaric acid	0.05
C18:0	Stearic acid	2.06
C20:0	Arachidic acid	0.75
C22:0	Behenic acid	0.29
C24:0	Lignoceric acid	0.55
<b>*SFA</b>		25.84
C16:1	Pamitoleic acid	0.18
C18:1	Oleic acid	41.18
C20:1	Eicosenoic acid	0.41
<b>*MUFA</b>		41.77
C18:2	Linoleic acid	31.27
C18:3	Linolenic acid	1.13
<b>*PUFA</b>		32.40

\*SFA: Saturated fatty acid; MUFA: Monounsaturated fatty acid; PUFA: Polyunsaturated fatty acid

Recovery of  $\gamma$ -oryzanol from soapstock and acid oil has become of research interest in determining appropriate methods for separation and purification processes. Chromatography is one of several techniques used for separation and purification of natural compounds. It is an effective method giving high purity substances. The principal of chromatography is described as follow.

## 2.6 Chromatography

Chromatography is a separation technique for the separation mixtures based on the different interactions of the compounds with two phases: the mobile phase and the stationary phase. The mixture is dissolved in a liquid called a mobile phase. Components of the mixture are partitioned between an adsorbent which is a stationary phase and a solvent which is a mobile phase that flows through the adsorbent. The components which are quite soluble in a stationary phase will take longer to travel through an adsorbent than the components which are not very soluble in a stationary phase but very soluble in a mobile phase. The classification of chromatography is shown in Table 2.6.

**Table 2.6** Classification of chromatography (www.chemistry.sc.chula.ac.th)

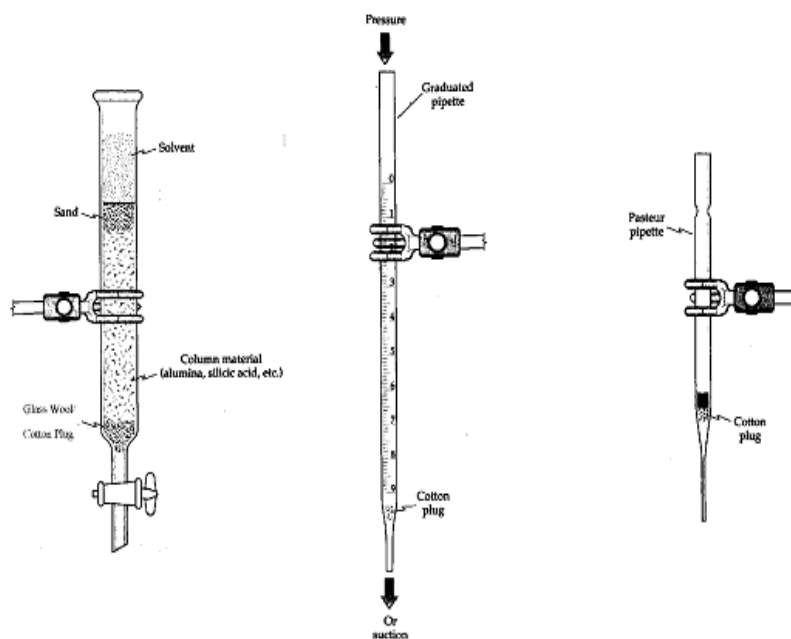
Chromatography	Stationary phase	Mobile phase	Principle
Column Chromatography	Solid	Liquid	Adsorption
Thin-Layer Chromatography(TLC)	Solid	Liquid	Adsorption
Gas-Solid Chromatography	Solid	Gas	Adsorption
Paper Chromatography	Liquid	Liquid	Partition
Gas-Liquid Chromatography	Liquid	Gas	Partition

Nowadays, chromatography techniques commonly used in the laboratory are column chromatography and thin-layer chromatography.

### Column chromatography

Column chromatography is one of the most useful methods for separation and purification of various mixtures such as organic compounds, natural products and so on. The principle of column chromatography is based on differential adsorption of

substance by the adsorbent. The adsorbent which is a stationary phase such as silica, alumina calcium, phosphate, magnesia and starch is contained in a column chromatography. A mixture which is a liquid sample is introduced at the top of the column and is allowed to pass through the column slowly. Then, the solvent which is a mobile phase carries the mixture through the column. The components are adsorbed at different areas depending on their ability for adsorption. The components which are quite soluble in a stationary phase will take longer to travel through an adsorbent than the components which are not very soluble in a stationary phase but very soluble in a mobile phase. There are many types of column chromatography used for separation and purification shown in Figure 2.3.



**Figure 2.3** Type of column chromatography

### Thin-layer chromatography (TLC)

Thin layer chromatography (TLC) is one of a chromatography technique used for identification and separation of mixtures because it is simple, rapid and inexpensive technique. TLC is usually used to verify the purity of organic compounds during separation processes. TLC is also used to confirm the type of substances and detect the components in the mixture.



The principle of TLC is the same as that of the column chromatography. TLC differs from the column chromatography in that, in TLC, the stationary phase is coated and attached on a piece of mirror, a piece of aluminum or a piece of thin plastic. Samples are spotted on TLC plates, which are then placed in the chamber containing a mobile phase. When the mobile phase is adsorbed and travels up the TLC plate by capillary action, the components dissolve in the solvent and move up the TLC plate. Individual components move up at different rates, depending on intermolecular forces between the component and the stationary phase and the component and the mobile phase. Unlike a column chromatography, due to a very small amount of sample for analysis, TLC is suitable for analysis rather than for separation of the mixture in order to collect each component. Another benefit of TLC is that it can be used to quickly determine the appropriate mobile phase before applying a column chromatography. The selection of the suitable mobile phase by using TLC is related to what is referred to as the  $R_f$  value. This parameter is a retention factor that is used to measure the distance of component spots relate to the distance of the eluent. The  $R_f$  of the interested component on TLC plate should not be below 0.2 and should not be more than 0.8. If  $R_f$  is below 0.2, the component moves too slowly through the plate, resulting in long retention time. If  $R_f$  is more than 0.8, the component moves too quickly resulting in poor product separation.

#### Efficiency of chromatographic column

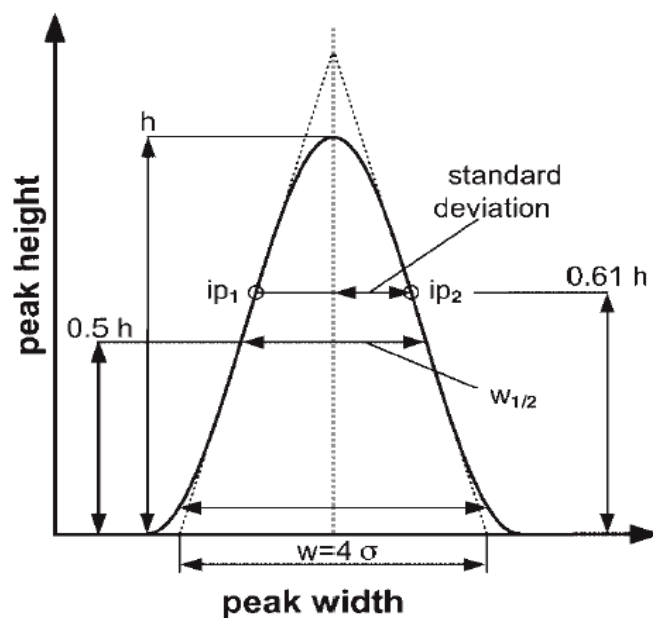
Plate number ( $N$ ) is a parameter that characterizes the efficiency of a chromatography column. It is related to the height of an equivalent theoretical plate (HETP), according to the following equation:

$$HETP = \frac{L_c}{N} \quad (2.1)$$

where  $L_c$  is the height of the column (cm).

For the symmetric peak, retention time for a compound eluted from the chromatography column can be determined from the highest point of the eluted peak. The efficiency of adsorbent for symmetrical peaks such as that shown in Figure 2.4

can be calculated assuming the Gaussian distribution ( $w$ ). In other words, the plate number for symmetric peak can be determined from equation 2.2.

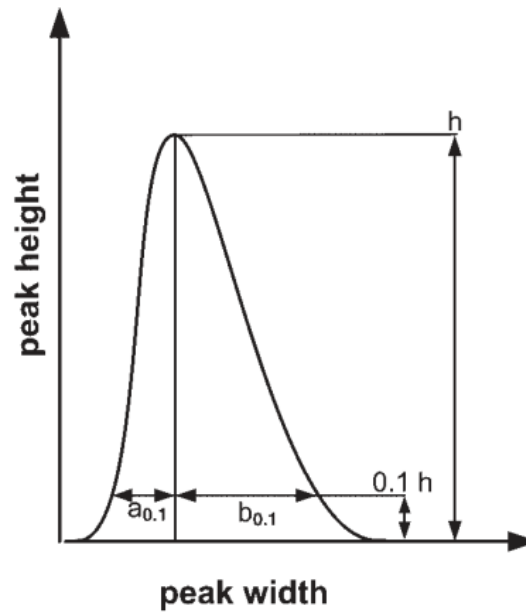


**Figure 2.4** Determination of symmetric peak

$$N_i = 16 \left( \frac{t_{R,i}}{w_i} \right)^2 \quad (2.2)$$

where  $t_{R,i}$  and  $w_i$  are retention and the width of the chromatographic peak of component  $i$ , respectively.

On a contrary, for an asymmetric peak such as that shown in Figure 2.5, the retention time can be determined by the first absolute moment ( $\mu_t$ ) and the second central moment (or variance  $\sigma_t^2$ ), according to equation 2.3 and equation 2.4, respectively.



**Figure 2.5** Determination of asymmetric peak

The first absolute moment ( $\mu_t$ ):

$$\mu_t = \frac{\int_0^{\infty} tc(t)dt}{\int_0^{\infty} c(t)dt} \quad (2.3)$$

The second central moment ( $\sigma_t^2$ ):

$$\sigma_t^2 = \frac{\int_0^{\infty} (t - \mu)^2 c(t)dt}{\int_0^{\infty} c(t)dt} \quad (2.4)$$

The plate number for asymmetric peak can be determined from equation 2.5.

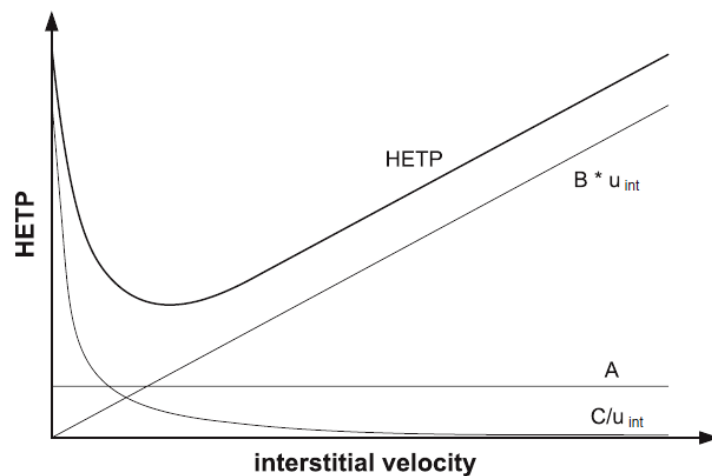
$$N_i = 41.7 \left[ \frac{\left( \frac{t_{R,i}}{W_{t0.1}} \right)^2}{1.25 + \frac{b_{0.1i}}{a_{0.1i}}} \right] \quad (2.5)$$

The column efficiency is largely affected by mass transfer behavior of various components through the stationary phase packed in the column, which in turns is

dependent on various parameters. The effect of different mass transfer parameters on the overall efficiency of the column are illustrated in Figure 2.6, which is the plot of plate height versus the mobile phase velocity. This plot can be mathematically expressed as in equation 2.6, which is called a van Deemter equation.

$$H_i = A_i + B_i \mu_{\text{int}} + \frac{C_i}{\mu_{\text{int}}} \quad (2.6)$$

The first term on the right hand side of the van Deemter equation represents the contribution from eddy diffusion term ( $A_i$ ). The second term ( $B_i \mu_{\text{int}}$ ) is mass transfer resistance term which  $\mu_{\text{int}}$  is velocity of fluid phase and the third term ( $\frac{C_i}{\mu_{\text{int}}}$ ) is related to the axial diffusion of the solute molecule in the fluid phase.



**Figure 2.6** Relationship between HETP and interstitial velocity

Eddy diffusion is resulted from the packing materials that cannot be perfectly packed or from the adsorbents with very board particle size distribution. The magnitude of the term ( $A_i$ ) generally depends on size of the packing materials. The plate height can be decreased when small particles of uniform size of adsorbent are used. Since eddy-diffusion does not vary with fluid velocity, the term  $A_i$  is a

constant. The term  $B_i\mu_{\text{int}}$  on the other hand is an effect of mass transfer resistance at high velocity. This term increases linearly with fluid velocity. At low fluid velocity, the velocity does not have an effect on the mass transfer resistance within the pores. On the other hand, if fluid velocity increases, the effect of this term on mass transfer resistance becomes larger. The slope of  $B_i\mu_{\text{int}}$  term in Figure 2.6 depends on the nature of packing materials. The particles with high pore accessibility and low diffusion path lengths would give a lower slope and thus higher efficiency at high fluid velocity. The last term in equation 2.6,  $\frac{C_i}{\mu_{\text{int}}}$ , is associated with axial diffusion of the solute molecules in the fluid phase. This term is generally observed in preparative chromatography column systems with large diameter adsorbent, operated at very low mobile phase flow rate. When the mobile phase flow rate is rather high on the other hand, this term can be neglected.

### Resolution

Resolution ( $R_s$ ) is a parameter used to determine the distance between two adjacent peaks. The resolution of two components can be determined in equation 2.7.

$$R_s = \frac{2(t_{R,j} - t_{R,i})}{w_i + w_j} \quad (2.7)$$

where  $t_{R,i}$  and  $t_{R,j}$  are retention times of component i and j, respectively, and of which component i is eluted first ( $t_{R,i} > t_{R,j}$ ).  $w_i$  and  $w_j$  are the widths, at the base line ( $w = 4\sigma$ ), of component i and component j peaks, respectively. If  $R_s$  is more than 1.5, the two components can be separated perfectly. If  $R_s$  is approximately 1.0, there are 3% of peak components overlapping.

## **2.7 Literature reviews**

In recent years, there have been researches on separation and purification of  $\gamma$ -oryzanol from various raw materials such as rice bran, rice bran oil, rice bran oil soapstock or acid oil. Various separation techniques are involved for separation and purification of  $\gamma$ -oryzanol such as solid-liquid extraction, liquid-liquid extraction, crystallization and chromatography. Reviews of these researches are summarized here.

### **2.7.1 Separation and purification of $\gamma$ -oryzanol from rice bran and crude rice bran oil**

There are many research studies concerning methods for separating and purifying  $\gamma$ -oryzanol from rice bran and crude rice bran oil such as extraction, crystallization and chromatography. In most of extraction works, hexane is usually used as the solvent to extract  $\gamma$ -oryzanol from rice bran (Johnson and Lusas, 1983). However, hexane is a hazardous solvent to environment and human. Hu et al. (1996) suggested that other than hexane, safer alternative solvent such isopropanol can be used. Their study demonstrated that both isopropanol and hexane have comparable efficiencies for  $\gamma$ -oryzanol extraction from rice bran. Despite that hexane can cause some environmental problems, it is still being used as a solvent for extraction  $\gamma$ -oryzanol from rice bran in industry and in laboratory.

In 2009, Zullaikah et al. studied the method for separation and purification of  $\gamma$ -oryzanol from crude rice bran oil (RBO). They proposed a two-step crystallization process, in which in the first crystallization step, they determined the effects of process parameters on the crystallization process. These parameters included the amount of solvent (methanol: acetone, 7:3 v/v) to RBO ratio, temperature and crystallization time. The results showed that the suitable condition for the first crystallization was 40/1 (ml/g) of solvent to RBO ratio, at  $-60^{\circ}\text{C}$  and 15 hours for crystallization time. Supernatant phase or  $\gamma$ -oryzanol-rich was kept at  $20.5^{\circ}\text{C}$  for 24 hours before it was used in the second crystallization step. In the second crystallization, 20 ml of hexane was added to as anti-solvent to the  $\gamma$ -oryzanol-rich

product and kept at 5°C for 48 hours. It was found that hexane has not an impact on the purity of  $\gamma$ -oryzanol but it can increase the recovery of  $\gamma$ -oryzanol from 42.40% to 59%. From the second crystallization, it can be concluded that the recovery and purity of  $\gamma$ -oryzanol as crystal were about 59% and 93-95% respectively.

The other alternative for isolation and purification of  $\gamma$ -oryzanol was chromatography. Chromatography is one of the most useful methods, usually used for separation and purification of various mixtures. For example, Lai S.M. et al. (2005) employed the method for purification  $\gamma$ -oryzanol from rice bran. In their experiment, 15 g of rice bran, 1 g of ascorbic acid and 3 mg of citric acid were extracted with 130 ml of hexane using a soxhlet apparatus for 2 hours to obtain cruder rice bran oil. The extraction yield and purity of  $\gamma$ -oryzanol from the cruder rice bran oil were found to be 16-18% (w/w) and 2.4-3% (w/w) respectively. Then normal phase preparative elution chromatography was used for purifying  $\gamma$ -oryzanol. The chromatography column consisted of a silica gel (12 $\mu$ m) packed as a stationary phase, and was operated by a three step gradient elution of mobile phase which comprises a mixture of hexane and ethyl acetate, from 85:15 to 50:50 v/v, and then to pure ethyl acetate. The normal phase high-performance liquid chromatography (NP-HPLC) with UV-detector at 319 nm was used to analyze  $\gamma$ -oryzanol using a mixture of hexane and ethyl acetate (95:5 v/v) as a mobile phase. The percent recovery and the purity of  $\gamma$ -oryzanol were found to be about 90% and 90-98% respectively.

Xu and Godber (1999) considered to study about chromatography methods as well in order to separate and purify ten components of  $\gamma$ -oryzanol from rice bran. 25 g of rice bran, 1 g of and ascorbic acid were extracted with a mixture of 35 ml of hexane and 15 ml of ethyl acetate to obtain crude rice bran oil. Then, the crude rice bran oil was dissolved in 50 ml of a mixture of hexane and ethyl acetate (9:1) prior to the pre-purification of  $\gamma$ -oryzanol in a normal-phase HPLC column packed with silica gel. A mixture of ethyl acetate and hexane (7:3) was used as a mobile phase. The semi-purified  $\gamma$ -oryzanol was then purified through a preparative scale normal phase HPLC using a mixture of ethyl acetate in hexane 4% v/v as a mobile phase. The  $\gamma$ -oryzanol fraction collected was then determined by an analytical reverse-phase HPLC using a mobile phase consisted of methanol/acetonitrile/dichloromethane/acetic acid (50:44:3:3 v/v/v/v). Then each fraction of reverse-phase HPLC was collected to

identify components of  $\gamma$ -oryzanol. The GC/MS with an electron impact mass spectrum was used to identify each component after components were transformed into trimethylsilyl ether derivative. Ten components were identified in the  $\gamma$ -oryzanol fraction, which were  $\Delta^7$ -stigmasteryl ferulate, stigmasteryl ferulate, cycloartenyl ferulate, 24-methylenecycloartanyl ferulate,  $\Delta^7$ -campestenyl ferulate, campesteryl ferulate,  $\Delta^7$ -sitotenyl ferulate, sitosteryl ferulate, compestanyl ferulate and sitostanyl ferulate. Three of these: cycloartenyl ferulate, 24-methylenecycloartanyl ferulate and campesteryl ferulate, were the major components of  $\gamma$ -oryzanol. Rogers et al., (1993) also considered major components of  $\gamma$ -oryzanol in crude rice bran oil. They used a reverse-phase semi preparative HPLC method in order to separate  $\gamma$ -oryzanol components in rice bran oil. For this experiment, crude rice bran oil which dissolved in 10% isopropanol was used as a sample to separate  $\gamma$ -oryzanol. A sample was transferred to a semi preparative HPLC using a mixture of methanol and isopropanol (95:5 v/v) as a mobile phase. Then chemical ionization mass spectrometry was used to identify major components in  $\gamma$ -oryzanol. Results from this experiment showed that cycloartenyl ferulate, 24-methylene cycloartanyl ferulate, campesteryl ferulate,  $\beta$ -sitosteryl ferulate and cycloartanyl ferulate were major components in  $\gamma$ -oryzanol.

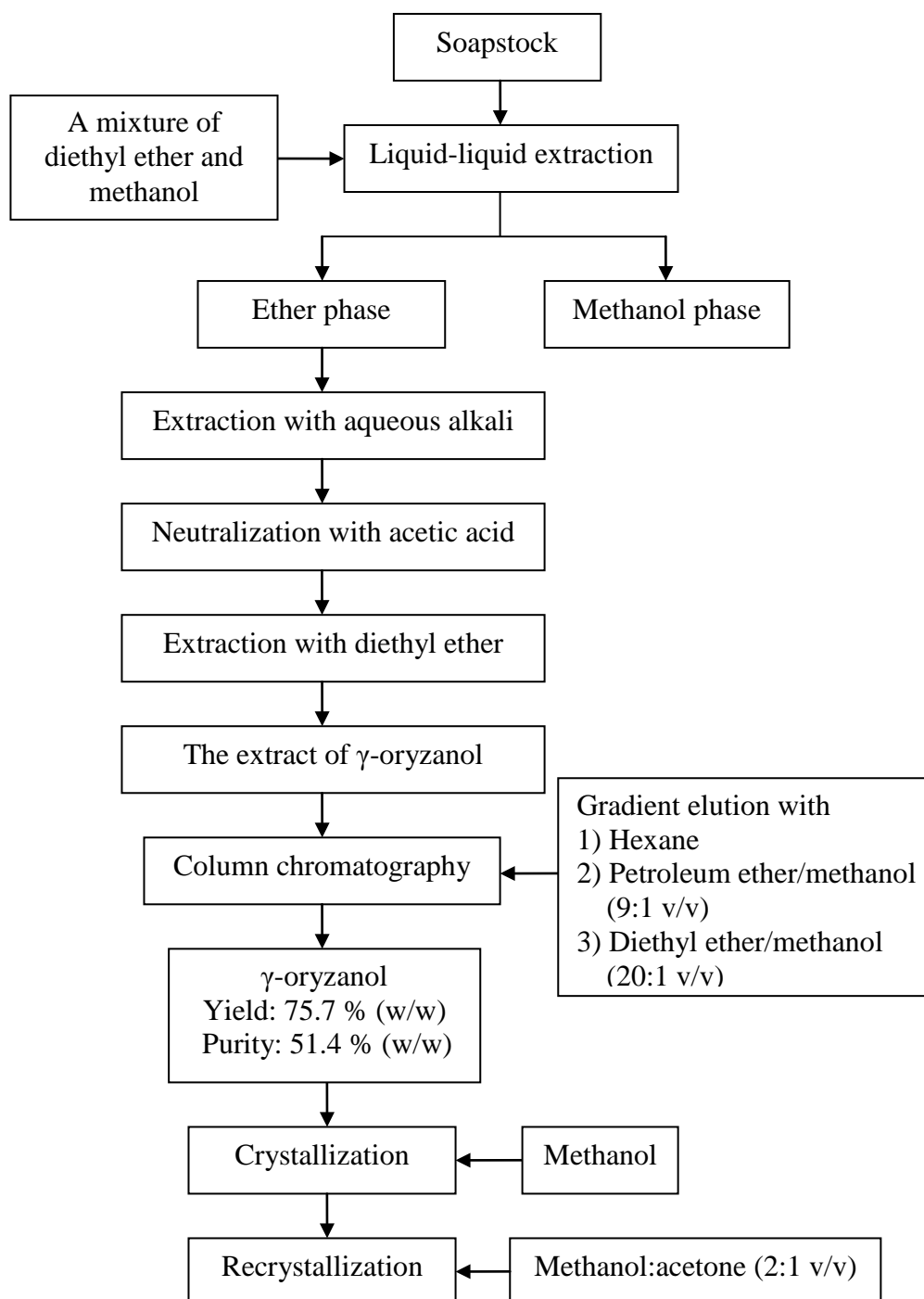
### **2.7.2 Separation and purification of $\gamma$ -oryzanol from rice bran oil soapstock and acid oil**

Soapstock is one of the by-products of chemical rice bran oil refining obtained in the neutralization step. Sometimes, to increase storage time, soapstock was reacted with added sulfuric acid to produce acid oil. Both soapstock and acid oil contain several important substances such as  $\gamma$ -oryzanol, tocopherol and vitamin E (Gopalakrishna, 2003) that offer health benefits to human. Therefore, there has been a great deal of research interest in recovering and purifying  $\gamma$ -oryzanol from soapstock and acid oil.

In 1989, Seetharamajah et al. studied extraction and purification of  $\gamma$ -oryzanol from soapstock using four-step process, which was composed of liquid-liquid extraction, column chromatography, crystallization and finally recrystallization. In the first step, soapstock was extracted with diethyl ether and methanol. The extract was



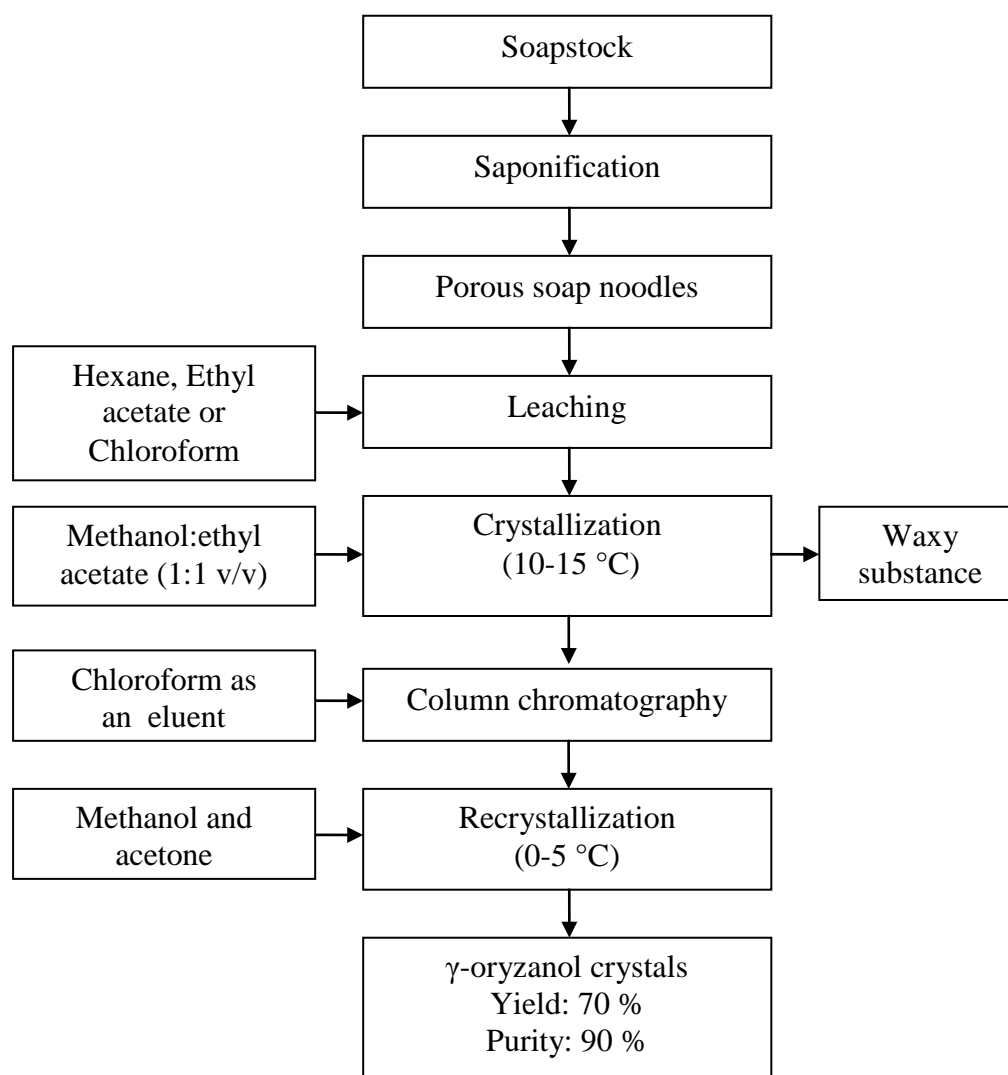
separated into two phases: the ether phase and methanol phase. The ether phase was then extracted with aqueous alkali in order to separate  $\gamma$ -oryzanol. After that, acetic acid was added in order to neutralize the extract. Finally,  $\gamma$ -oryzanol was extracted with diethyl ether to obtain the extract which would be subsequently purified in a normal phase column chromatography. For the second step, the extract was injected into chromatography column, which was operated by three-step gradient elution of mobile phase, consisted of hexane, followed by petroleum ether/methanol (9:1 v/v) and diethyl ether/methanol (20:1 v/v). The results from this experiment showed that the yield and purity of  $\gamma$ -oryzanol were 75.7% (w/w) and 51.4% (w/w) respectively. The third purification step was crystallization, in which methanol was used as a solvent. In final step, recrystallization was carried out using a mixture of methanol/acetone (2:1 v/v). The diagram of Seetharamajah et al.'s process is shown in Figure 2.7.



**Figure 2.7** Seetharamajah et al.'s process

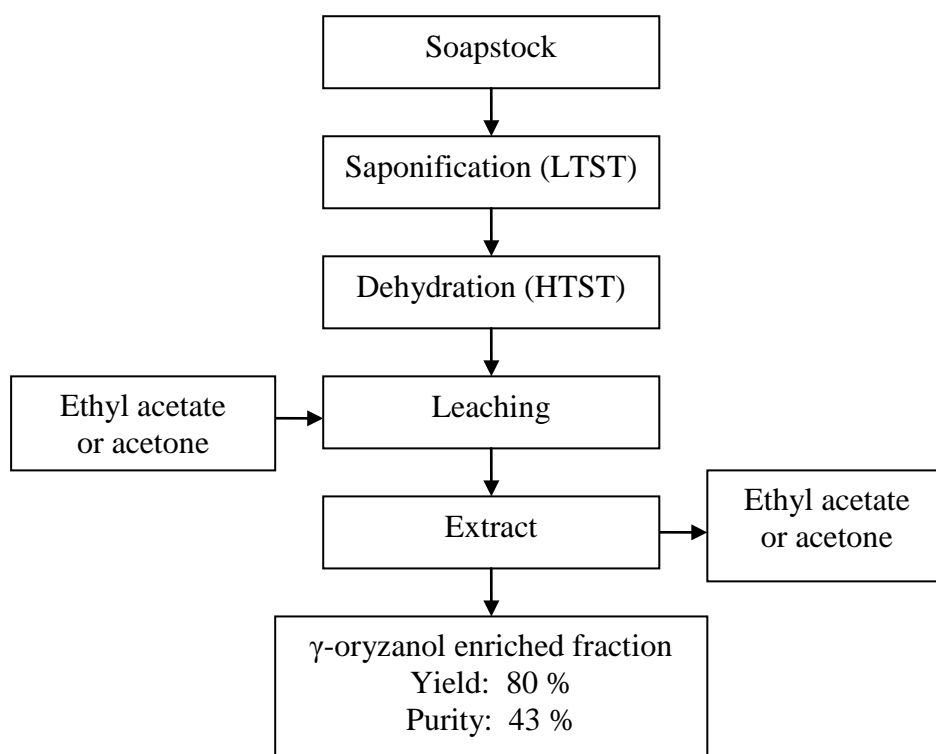
Due to high water content of soapstock, problems arise when attempting to separate  $\gamma$ -oryzanol from soapstock according to Seetharamajah et al.'s process. Not only large volume extractor would be required, the storage life of soapstock is also

very short. Rao et al. (2002) proposed a solution to this problem by first saponifying the soapstock with alkaline in order to convert the remained glycerides into soap. Water was separated and remaining solid was formed into porous soap noodles, which could be easily extracted. The porous soap noodles were extracted with organic solvent such as hexane, ethyl acetate or chloroform. The extract was then crystallized in order to remove impurities. Then, column chromatography using chloroform as an eluent solvent was used to obtain  $\gamma$ -oryzanol rich fraction. The  $\gamma$ -oryzanol rich fraction was then purified further through a recrystallization step in an organic solvent using methanol and acetone as a solvent in order to obtain purified  $\gamma$ -oryzanol of approximately 90%. The diagram of Rao et al.'s process is shown in Figure 2.8.



**Figure 2.8** Rao et al.'s process

Later, Indira et al. (2005) proposed an improved the methods for isolating, particularly for extracting  $\gamma$ -oryzanol from rice bran oil soapstock. Their process involved saponification, and dehydration. The diagram of Indira et al.'s process is shown in Figure 2.9.

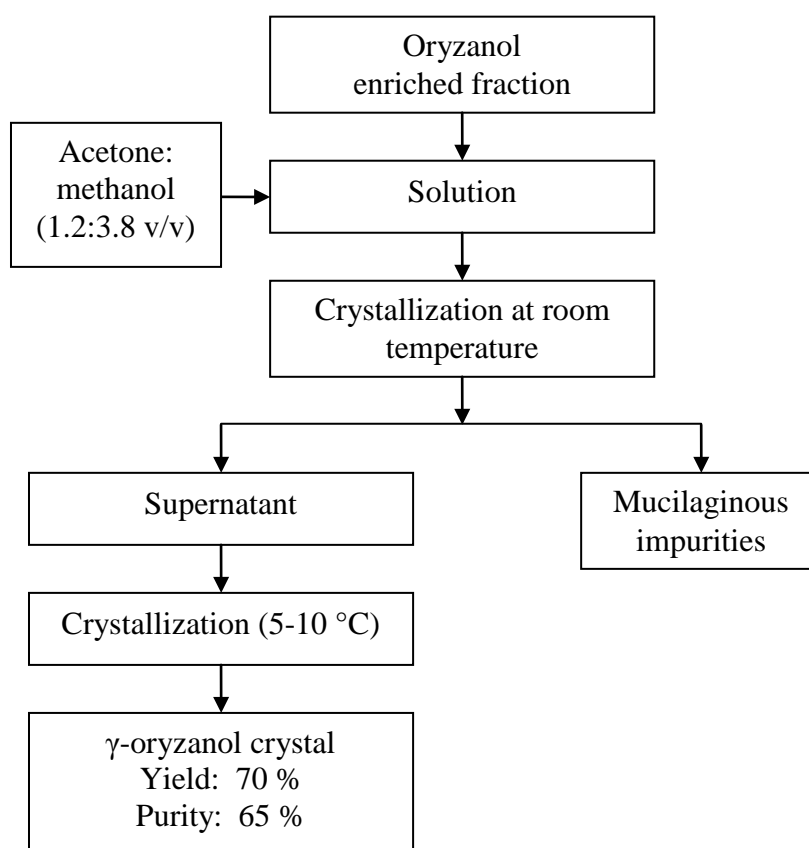


**Figure 2.9** Indira et al.'s process

In saponification step, low temperature and short time (LTST) were considered in order to protect degradation of  $\gamma$ -oryzanol during this process. The aim of the second dehydration step is to remove water which is a major component found in rice bran oil soapstock. Water is a problem for extraction process because it hinders extracting  $\gamma$ -oryzanol in the extraction step. Therefore, dehydration step is necessary for extracting  $\gamma$ -oryzanol from rice bran oil soapstock because dehydration can reduce some moisture in soapstock. The concept of dehydration step in this research was high temperature and short time (HTST). When soapstock was dehydrated,  $\gamma$ -oryzanol can be extracted from dried soapstock easily in the leaching step. In the final leaching step, organic solvent was used for extracting  $\gamma$ -oryzanol from dried rice bran oil soapstock. In 2009, Kumar et al. considered diverse solvents for the extraction

process of  $\gamma$ -oryzanol from dried soapstock. Dried soapstocks were extracted with 50 ml of various solvents such as ethyl acetate, ethyl methyl ketone, hexane, acetone, and isopropanol using a soxhlet apparatus for 6 hours. The solvent giving the maximum recovery of  $\gamma$ -oryzanol was found to be ethyl acetate.

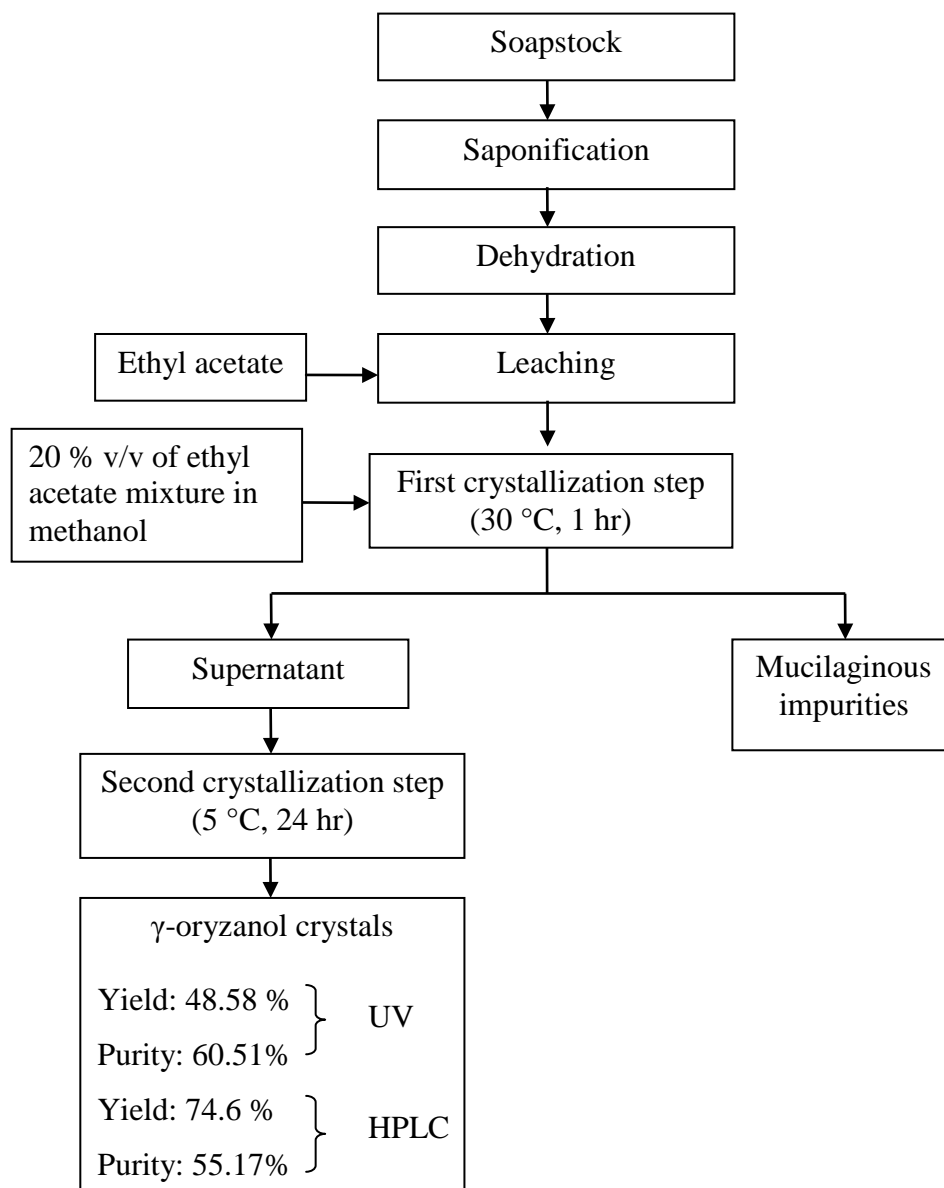
Taking Indira et al.'s extraction process, Narayan et al. (2004) presented the method for purification of  $\gamma$ -oryzanol from the oryzanol enrich fraction by employing crystallization using a mixture of acetone and methanol (1.2:3.8 v/v) as a solvent. The crystallization was operated at room temperature. Then, the extract was separated into two phases that were the mucilaginous impurities phase and the supernatant phase. The supernatant phase was used for crystallizing again at 5-10 °C. It was found that the yield and purity of this experiment were 70 % (w/w) and 65 % (w/w) respectively. The diagram of Narayan et al.'s process is shown in Figure 2.10.



**Figure 2.10** Narayan et al.'s process

Following Narayan et al.'s process, in 2007 Kaewboonnum studied the method for separation and purification  $\gamma$ -oryzanol from rice bran oil soapstock. This

experiment consists of four steps that were saponification, extraction or leaching, first crystallization step and second crystallization step. The diagram of Kaewboonnum's process is shown in Figure 2.11. First, soapstock was saponified with NaOH 2.4 % wt. Then saponified soapstock was dried and ground to extract in a soxhlet extractor. It was found that 15 g of raw material to 200 ml of ethyl acetate as a solvent was the suitable ratio for extraction. The extract was then analyzed by a UV-visible spectrophotometer. The yield of  $\gamma$ -oryzanol extract was 99.23 % wt and the purity of  $\gamma$ -oryzanol extract was 39.6 % wt. After that, the extract was purified in using two crystallization steps. In the first crystallization step, other than acetone: methanol mixture, the author proposed crystallization in 20 % v/v of ethyl acetate mixture in methanol at 30 °C for 1 hour. The extract was separated into two phases that were the mucilaginous impurities phase and the supernatant phase. Then the supernatant phase was used in the second crystallization step at 5 °C for 24 hours in order to get pure  $\gamma$ -oryzanol crystals.  $\gamma$ -oryzanol crystals obtain from soapstock was analyzed by both a UV-visible spectrophotometer and RP-HPLC with ELSD detector using a mixture of methanol and isopropanol (70:30 v/v) as a mobile phase. It was found that the yield and purity of  $\gamma$ -oryzanol crystals were 48.58 % and 60.51% wt, respectively as determined by UV-visible spectrophotometer analysis while the yield and purity of  $\gamma$ -oryzanol crystals were 74.6 % and 55.17% as determined by RP-HPLC.



**Figure 2.11** Kaewboonnum's process

For analysis the individual components of  $\gamma$ -oryzanol, in 2009, Kumar et al. studied the method for analysis the individual components of  $\gamma$ -oryzanol from dried soapstock. They used ethyl acetate for extracting  $\gamma$ -oryzanol from dried soapstock. Then, a reverse phase high-performance liquid chromatography (RP-HPLC) with diode array detector at 314 nm was used to analyze the individual components in  $\gamma$ -oryzanol using gradient mode of mobile phase. A mobile phase consisted of a mixture of methanol and acetonitrile that increased from 0% to 100% for 30 minutes and then

decreased from 100% to 0% for 35 minutes. It was found that fractions of  $\gamma$ -oryzanol were 24-methylene cycloartanyl ferulate, cycloartenyl ferulate, campesterol ferulate and  $\beta$ -sitosterol ferulate.

In past few years, acid oil has been considered for study in order to separate  $\gamma$ -oryzanol because it can be easily handled and has extended storage life. In 1999, Das et al. proposed method for separating and purifying  $\gamma$ -oryzanol from crude dark acid oil by combining column chromatography and crystallization methods. Due to high free fatty acid in crude dark acid oil, the process began with distillation of crude dark acid oil under high vacuum in order to reduce the free fatty acid content from 50-60% in original acid oil to only 10% in the residue oil that was remained after distillation. The remaining acid oil was then hydrolyzed with NaOH to remove glycerides by converting them to fatty acids. The hydrolyzed acid oil was then separated from the reaction mixture and was added with aqueous solution  $\text{CaCl}_2$  solution form  $\gamma$ -oryzanol containing precipitate. The precipitate was air dried, and then extracted with ethyl acetate. The extract was then washed with alkali and water, followed by drying over anhydrous sodium sulfate. The ethyl acetate was evaporated, and purification of  $\gamma$ -oryzanol was then carried out further by column chromatography packed with silica gel using chloroform as an eluent. Fractions were collected and after the removal of chloroform, the residue was further purified by activated charcoal treatment in hot methanol solution. The residue white  $\gamma$ -oryzanol crystals were found to have approximately 85% purity and the recovery was in the range between 54 to 86%.

In 2005, Kittiruangthong proposed the method for isolation  $\gamma$ -oryzanol from acid oil and also studied the effect of hydrolysis method for extraction  $\gamma$ -oryzanol. For Kittiruangthong's experiment, 1 ml of acid oil was hydrolyzed with 5 ml of 2 N NaOH and heated at 80 °C for 10 minutes. Then both 5 ml of non-hydrolyzed acid oil and hydrolyzed acid oil was extracted with 5 ml of ethyl acetate in the extraction step. The extract was separated using a centrifuge at 4000 rpm for 5 minutes. The ethyl acetate phase was collected for analysis. A UV-visible spectrophotometer was used for finding the yield of  $\gamma$ -oryzanol in the extract while HPLC was used for the analysis of  $\gamma$ -oryzanol purity. The purity of  $\gamma$ -oryzanol from the extract of non-hydrolyzed acid oil and hydrolyzed acid oil were 14.4% and 29.1% respectively. It



can be concluded that hydrolyzed acid oil gave purer of  $\gamma$ -oryzanol than non-hydrolyzed acid oil and the yield of  $\gamma$ -oryzanol from hydrolyzed acid oil was 96.91

## CHAPTER III

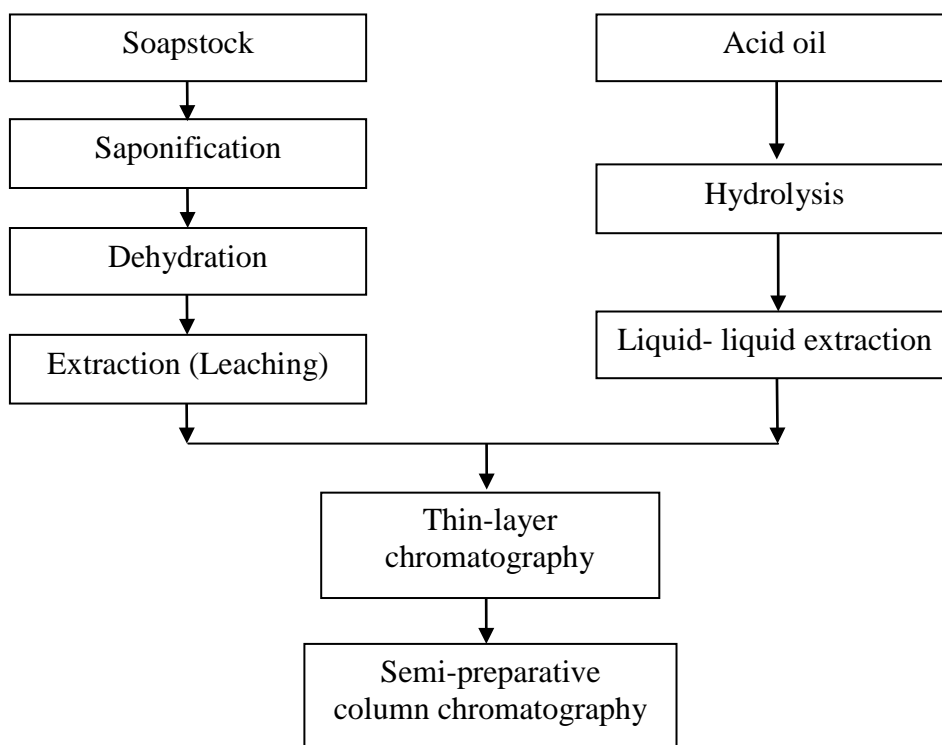
### MATERIALS & METHODS

#### Materials and chemicals

Soapstock and acid oil were obtained from Thai Edible Oil Co., Ltd., Samutprakarn, Thailand.  $\gamma$ -oryzanol standard was purchased from Santa cruz biotechnology. Oleic acid standard was purchased from Sigma-Aldrich, India. Chemicals such as ethyl acetate, methanol, isopropanol, hydrochloric acid were purchased from Merck, USA. Hexane was purchased from Lab scan, Ireland. Sodium hydroxide and sodium bicarbonate were purchased from APS fine chem, NSW, Australia. Thin-layer chromatography and silica gel (LiChroprep® Si 60) were purchased from Merck, Germany and pH indicator sticks were purchased from Sigma-Aldrich, Germany.

#### Methods

The aim of this work is to separate and purify  $\gamma$ -oryzanol from by-products of rice bran oil process. Two raw materials are used in this experiment: soapstock and acid oil. The procedures of this experiment consist of two parts: extraction and purification, First, the suitable raw materials was first selected based on the ease of extraction processes which differs due to the differences in the composition of the two raw materials. If selected, it would undergo purification process, following the procedure outlined in Figure 3.1 and that described in more detail below.



**Figure 3.1** Process for separation and purification of  $\gamma$ -oryzanol from by-products of rice bran oil process

### 3.1 Recovery of $\gamma$ -oryzanol from Soapstock

#### 3.1.1 Characterization of soapstock

##### 3.1.1.1 pH

5 g of soapstock sample was first dissolved in 20 ml of deionized water. The sample was then stirred and heated to 40 °C until it completely dissolved. The pH of the solution was then measured.

##### 3.1.1.2 Moisture content

The soapstock sample was dried in an oven at 105±2 °C until a constant weight was reached. The moisture content of the soapstock was then determined from the difference between the initial and the final weights.

### 3.1.1.3 Content of $\gamma$ -oryzanol and other components in soapstock

In determining the content of  $\gamma$ -oryzanol and other components in soapstock, the original soapstock was dehydrated in an oven at  $105\pm 2$  °C in order to remove water. Then, 3 g of the dried original soapstock was extracted in a soxhlet extractor for 4 hours using 200 ml of ethyl acetate as a solvent. The extract was then analyzed using HPLC apparatus with a mixture of methanol and isopropanol (60:40 v/v) as a mobile phase. The percentage of the component in the extract dried soapstock was determined from the following equation:

% Component i in dried soapstock extract =

$$\frac{\text{The amount of the component i}}{\text{The total weight of the original dehydrated soapstock}} \times 100 \quad (3.1)$$

### 3.1.2 Separation of $\gamma$ -oryzanol from soapstock

As shown in Figure 3.1, separation  $\gamma$ -oryzanol from soapstock requires 3 steps prior to purification, which are saponification of soapstock, dehydration and extraction of  $\gamma$ -oryzanol from the dried saponified soapstock. The procedure for each step is described detail below.

#### 3.1.2.1 Saponification and dehydration

Saponification was carried out in order to convert remaining triglyceride in the soapstock sample into glycerol and fatty acids. In this step, 100 g of soapstock and 2.4 g of sodium hydroxide dissolved in 20 ml of methanol were reacted and stirred at 100 °C for 2 hours (Kaewboonnum, 2007). After 2 hours, sodium bicarbonate was added for neutralization of the reaction. Then, the saponified soapstock was dehydrated in a vacuum oven at 90°C and was ground in order to extract  $\gamma$ -oryzanol in the leaching step.

#### 3.1.2.2 Extraction (Leaching)

In the leaching step, 15 g of the saponified soapstock was extracted with 200 ml of ethyl acetate in a soxhlet apparatus for 4 hours. The saponified soapstock

residue was reextracted two times under sonication at 40 °C. Then the extracts were combined and then analyzed using HPLC for the content various components including  $\gamma$ -oryzanol, glycerides and fatty acid. Here again, the percentage of each component in the extract of dried saponified soapstock was determined based on the following equation:

% Component i in extract of saponified soapstock =

$$\frac{\text{The amount of the component i}}{\text{The total weight of the dried saponified soapstock}} \times 100 \quad (3.2)$$

## 3.2 Acid oil

### 3.2.1 Characterization of acid oil

#### 3.2.1.1 pH

The pH of the acid oil sample was determined using pH indicator sticks.

#### 3.2.1.2 Content of $\gamma$ -oryzanol and other components in acid oil

The amount of  $\gamma$ -oryzanol in the starting acid oil sample was determined and was used as a basis for calculation of the  $\gamma$ -oryzanol content recovered at each separation step. To do so, 5 ml of the original acid oil was extracted twice each time with 5 ml of ethyl acetate. The acid oil ethyl acetate mixture was agitated using a vortex mixer for 1 minute. The extract phases were separated using a centrifuge at 4000 rpm for 5 minutes and combined. The analysis of the extract was carried out to determine the content of  $\gamma$ -oryzanol, glycerides and fatty acids in the extract. The percentage of each component in the extract is determined based on an analogous equation with equation 3.3, which is

% Content of component i in extract of acid oil =

$$\frac{\text{The amount of the component i}}{\text{The total weight of the dried acid oil}} \times 100 \quad (3.3)$$

### 3.2.2 Separation of $\gamma$ -oryzanol from acid oil

As highlighted in Figure 3.1, to separate  $\gamma$ -oryzanol from acid oil, two steps are required. First, acid oil was hydrolyzed with alkaline to get the hydrolyzed acid oil. Then, the hydrolyzed acid oil was extracted with ethyl acetate using liquid-liquid extraction step. The detailed procedures are described below.

#### 3.2.2.1 Hydrolysis of acid oil

To hydrolyze the acid oil, 1 ml of acid oil was reacted with 5ml of 2N of sodium hydroxide. The mixture was agitated using a vortex mixer for 1 minute and then heated to 80 °C for 10 minutes, after which, the pH of the mixture was adjusted to 9.5 using 1N hydrochloric acid. Then, the hydrolyzed acid oil was extracted with ethyl acetate by liquid-liquid extraction.

#### 3.2.2.2 Liquid-liquid extraction

For the extraction of  $\gamma$ -oryzanol, 5 ml of hydrolyzed acid oil was extracted twice, each time with 5 ml of ethyl acetate. Each extraction was carried out under agitation for 1 minute using a vortex mixer. The extract was separated using a centrifuge at 4000 rpm for 5 minutes. The ethyl acetate phases from both extractions were combined and analyzed for  $\gamma$ -oryzanol, glycerides and fatty acid content using HPLC. The percentage of each component in the extract was determined and reported using equation 3.4.

% Content of component i in extract of hydrolyzed acid oil =

$$\frac{\text{The amount of the component i}}{\text{The total weight of the dried hydrolyzed acid oil}} \times 100 \quad (3.4)$$

Based on the ease of pretreatment and extraction procedures as well as the composition of the extracts obtained from soapstock and acid oil, a suitable raw material (soapstock or acid oil) will be selected for further investigation of chromatographic purification. The following sections describe procedures for chromatographic purification of  $\gamma$ -oryzanol from the sample (soapstock or acid oil) extracts.

### 3.3 Thin-layer chromatography

As a preliminary study for screening the suitable mobile phase, thin-layer chromatography plates coated with silica gel (TLC silica gel 60 F<sub>254</sub>, 25 Aluminum sheets 20 x 20 cm, Merck, Germany) were employed. The ratio of mobile phases examined were mixtures at various compositions of hexane and ethyl acetate (95:5, 90:10, 85:15, 80:20, 75:25, 70:30, 65:35, 60:40, 55:45 and 50:50 v/v). The extract in ethyl acetate was spotted on TLC plates, which were then placed in the chamber containing the mobile phase. After the mobile phase reached the marked line at the top of the TLC plate, the plate was taken out of the solvent and was allowed to dry off. The TLC plate was then placed in a chamber containing iodine vapor. The plate was left in the chamber until a light brown color was developed over the entire plate. The components in the sample traversing up the TLC plates were compared against the  $\gamma$ -oryzanol standard (purity 99 %), fatty acid (oleic acid) and glycerides (rice bran oil). The suitable mobile phase mixture suggested by TLC experiment was then used in a normal phase semi-preparative chromatography column in subsequent study.

### 3.4 Semi-preparative column chromatography

In this work, semi-preparative glass chromatography columns packed with various particle sizes (15-25  $\mu\text{m}$  and 25-40  $\mu\text{m}$  and 40-63  $\mu\text{m}$ ) and amount of (5 g, 10 g and 15 g) of silica gel were tested to determine the effects of these parameter on the column performance on  $\gamma$ -oryzanol purification. In addition, the effects of operational modes (isocratic elution versus gradient elution modes) were also investigated. Here, the sample stock solution (saponified soapstock extract or hydrolyzed acid oil extract) was loaded into the semi-preparative glass column chromatography. The suitable mobile phase mixture determined previously by the TLC experiment was then flown gravimetrically through the column. Fractions were collected at 5 minutes intervals and were analyzed for the amount of  $\gamma$ -oryzanol using HPLC. The analysis of all fractions allowed the determination of the yield and purity. The %purity was determined based on the percentage of the area under  $\gamma$ -oryzanol peak shown in the chromatogram. The %yield was calculated based on

all the collected fractions having  $\gamma$ -oryzanol purity higher than 95%.

### **3.5 Analysis of $\gamma$ -oryzanol**

Quantitative and qualitative analyses of the ethyl acetate extracts of the soapstock and acid oil were carried out with reverse phase high performance liquid chromatography (HPLC). The HPLC apparatus employed in this study consisted of a pump (Alltech model 626, USA), equipped with ELSD detector (Alltech ELSD 2000ES, USA). The detector condition was set at the tube temperature of 60 °C, nitrogen gas flow of 1.7 L/min and the impactor was off. The column was set at room temperature or about 25 °C on uBondapak C18, 125 Å, 10  $\mu$ m, 3.9 mm I.D $\times$  300 mm. The mobile phase is composed of methanol to isopropanol (60:40 v/v), and the flow rate was controlled at 0.9 ml/min.



## CHAPTER IV

### RESULTS & DISCUSSION

#### 4.1 Properties of soapstock and acid oil

Both soapstock and acid oil in this study were obtained from Thai Edible Oil Co., Ltd., Samutprakarn, Thailand. Soapstock is a main by-product from the chemical refining process having a dark brown color (Figure 4.1), and containing high amount of  $\gamma$ -oryzanol. Although the composition of the soapstock may vary depending on the rice bran oil extraction conditions and the rice bran oil processing conditions, it consists mainly of water, soap, glycerides and unsaponnified matter.



**Figure 4.1** Soapstock sample

In this study, properties such as pH and moisture content of the soapstock were determined. In addition, the extract of the original soapstock in ethyl acetate was also analyzed and was found to contain three main components including  $\gamma$ -oryzanol, glycerides and fatty acid. The percentage of these components and the physical properties of the soapstock are summarized in Table 4.1. The pH of soapstock used in

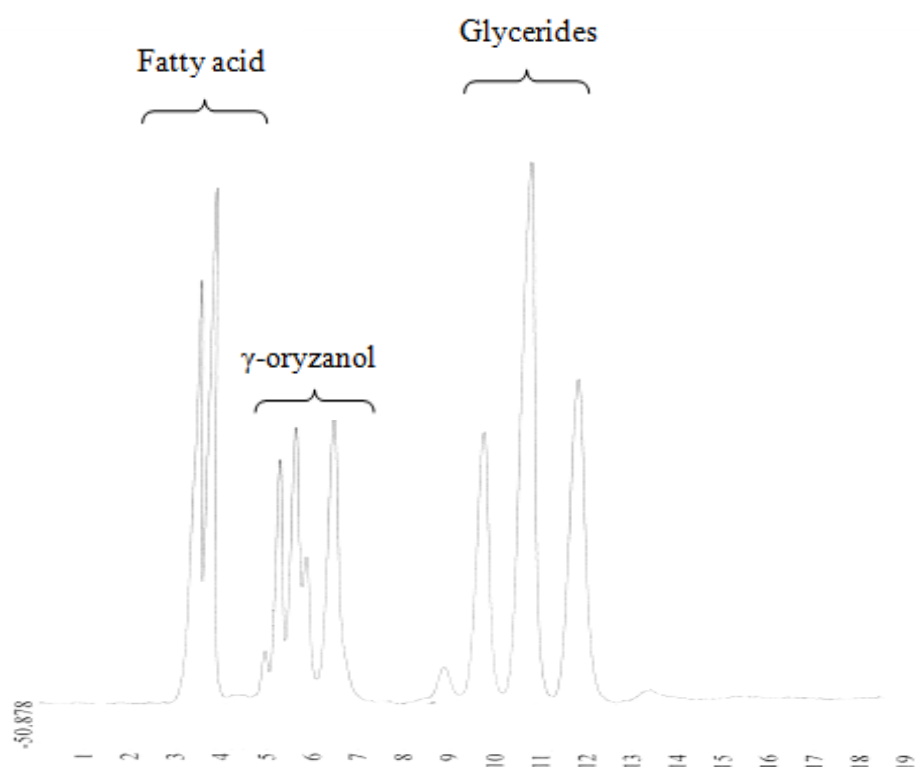
this study was found to be about 11.0 and moisture content was approximate 24.49%. The remaining 75.51% are soap, glycerides and unsaponifiable matters.

The HPLC analysis of the ethyl acetate extract of the dried soapstock suggested that the extract contained mostly glycerides (69.67 % based on dry basis), followed by  $\gamma$ -oryzanol (6.73 %wt based on dry basis) and fatty acid (3.53 %wt based on dry basis). The chromatogram of the dehydrated soapstock extract is shown in Figure 4.2. The result for  $\gamma$ -oryzanol content corresponded with Kaewboonnum et al., (2007) in which the content of  $\gamma$ -oryzanol was found to be 4.9 %wt on wet basis or 7.7 %wt based on dry basis. Other research studies reported the  $\gamma$ -oryzanol content to vary from 1.5-6.5 wt % based on wet basis [Rao et al. (2002), Indira et al. (2005), and Narayan et al. (2006)].

**Table 4.1** Properties of soapstock

Properties of soapstock	
pH	11
Moisture content <sup>a</sup>	24.49 %wt
$\gamma$ -oryzanol content in soapstock extract <sup>b</sup>	6.73 %wt (dry basis)
Glycerides content in soapstock extract <sup>c</sup>	69.67 %wt (dry basis)
Fatty acid content in soapstock extract <sup>d</sup>	3.53 %wt (dry basis)

a see appendix B, b see appendix C-1, c see appendix C-2 and d see appendix C-3



**Figure 4.2** Chromatogram of dehydrated soapstock extract

As another by-product of interest in this study, acid oil, which was obtained from soapstock by a reaction with sulfuric acid solution, was examined. As shown in Figure 4.3, acid oil is a viscous liquid, having brown or black color, and is insoluble in water.



**Figure 4.3** Acid oil sample

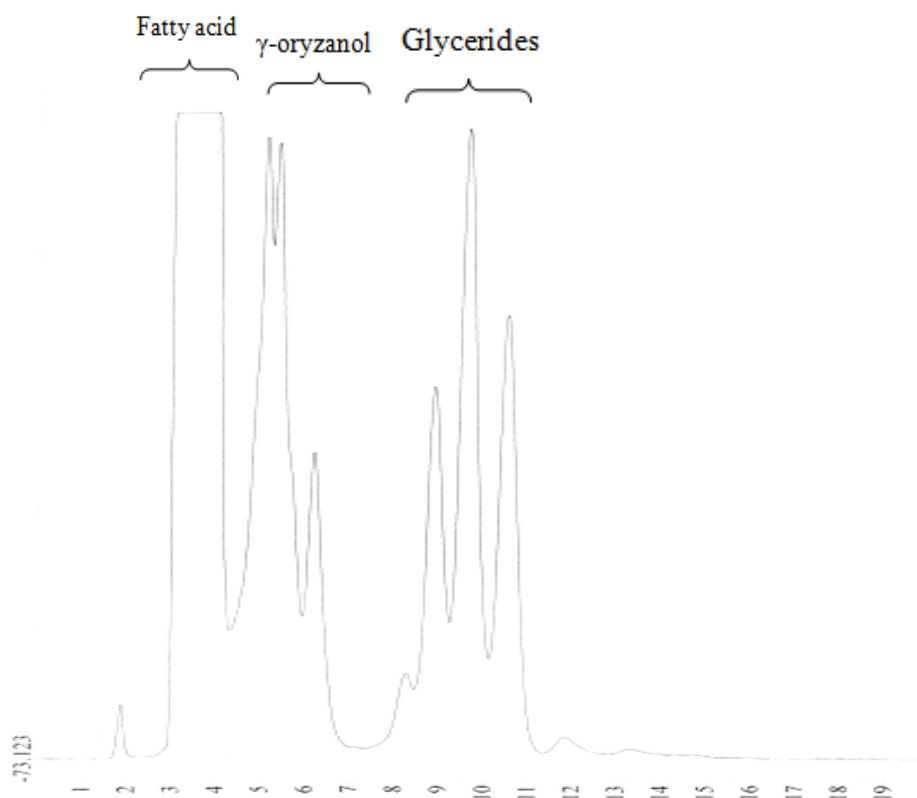
The pH and the moisture content of acid oil are summarized in Table 4.2. Since acid oil consists mostly of fatty acid, the pH of acid oil (pH=5.0) is much lower than that of soapstock. The moisture content of acid oil is also much lower (1.5 %wt [Thai Edible Oil Co., Ltd.]) since water has previously been removed. The pH of acid oil used in Kittiruangthong' study was found to be approximately 4.35. Also summarized in Table 4.2 are the contents of  $\gamma$ -oryzanol, glycerides and fatty acids in the extract of acid oil in ethyl acetate. The extract also contained glycerides in the highest amount (29.61 %wt based on dry basis), followed by fatty acid (7.69 %wt based on dry basis), and  $\gamma$ -oryzanol (6.36 %wt based on dry basis). Since acid oil is mostly fatty acids, the fatty acid content recovered in the ethyl acetate was also high (compared with the fatty acid content in soapstock). The chromatogram of acid oil extract obtained by liquid-liquid extraction with ethyl acetate is shown in Figure 4.4.

It can be drawn from the analysis of the extracts from both soapstock and acid oil, major impurities are those of glycerides and fatty acids which need to be removed to obtain high purity product.

**Table 4.2** Properties of acid oil

Properties of acid oil	
pH	5.0
Moisture content <sup>e</sup>	1.5 %wt
$\gamma$ -oryzanol content in acid oil extract <sup>f</sup>	6.36 %wt (dry basis)
Glycerides content in acid oil extract <sup>g</sup>	29.61 %wt (dry basis)
Fatty acid content in acid oil extract <sup>h</sup>	7.69 %wt (dry basis)

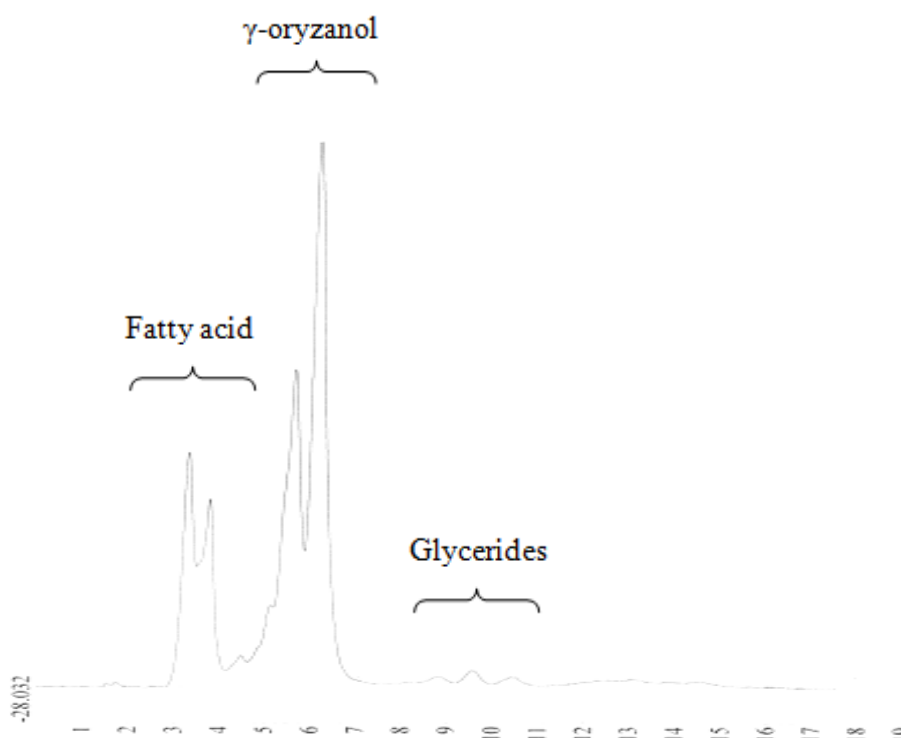
e Information from Thai Edible Oil Co., Ltd. f see appendix C-8, g see appendix C-9 and h see appendix C-10



**Figure 4.4** Chromatogram of acid oil extract

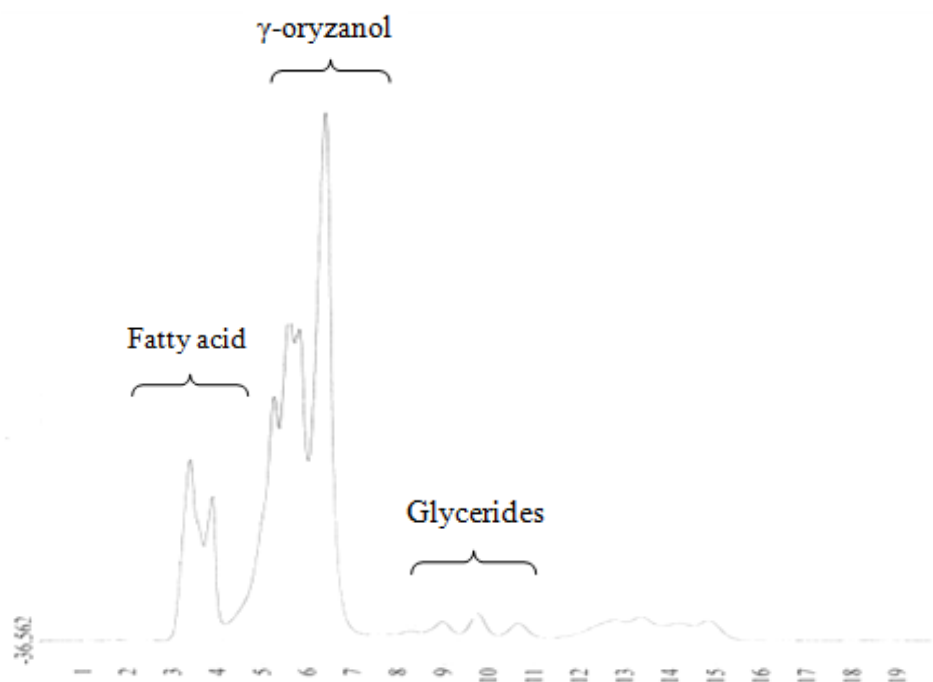
#### 4.2 Extraction of saponified soapstock and extraction of hydrolyzed acid oil

For soapstock, separation  $\gamma$ -oryzanol from soapstock begins with saponification, in which the soapstock was reacted with NaOH 2.4 %wt in methanol [Kaewboonnum (2007)] in order to remove glycerides. The saponified soapstock was then dried and extracted with ethyl acetate. As summarized in comparison with the content in the extract of the original soapstock in Table 4.3, the content of  $\gamma$ -oryzanol, glycerides and fatty acid in the extract were found to be 4.07 %wt, 0.57 %wt and 1.85 %wt based on dry basis, respectively. It should be noted that although glycerides became much lower, a 41.15% of  $\gamma$ -oryzanol content from in the original soapstock was observed (from 6.73 %wt to 4.07%wt based on dry basis). (See Appendix C-7 for sample calculation for percentage of  $\gamma$ -oryzanol loss). This corresponded to the results reported by Kaewboonnum et al, 2007, in which nearly 40.5 % loss of  $\gamma$ -oryzanol content was resulted by the saponification process. The chromatogram of the extract of saponified soapstock is shown in Figure 4.5. It should be noted that glycerdies peak became much reduced after saponification of the soapstock.



**Figure 4.5** Chromatogram of the extract of saponified soapstock

Similarly, glycerides in acid oil needs to be removed. To do so, acid oil was hydrolyzed with NaOH in water to convert glycerides to fatty acids. The hydrolyzed acid oil was then extracted with ethyl acetate and analyzed. Summarized in Table ? along with the contents of the three main components (  $\gamma$ -oryzanol, glycerides and fatty acid) in the original acid oil, the content of these components in the hydrolyzed acid oil extract were found to be 5.38 %wt, 0.87 %wt and 13.50 %wt based on dry basis, respectively. In this case, while glyceride content was reduced, the  $\gamma$ -oryzanol loss during the hydrolysis process was found to be 12.90 %, which was much lower than that in case of soapstock. On the other hand, the fatty acid content in the extract of hydrolyzed acid oil was increased (7.69% to 13.50%). The sample calculation of  $\gamma$ -oryzanol content in hydrolyzed acid oil is shown in Appendix C-11. The chromatogram of the extract of hydrolyzed acid oil is shown in Figure 4.6.



**Figure 4.6** Chromatogram of the extract of hydrolyzed acid oil

**Table 4.3** Comparison of each component in both saponified soapstock extract and hydrolyzed acid oil extract based on dry basis

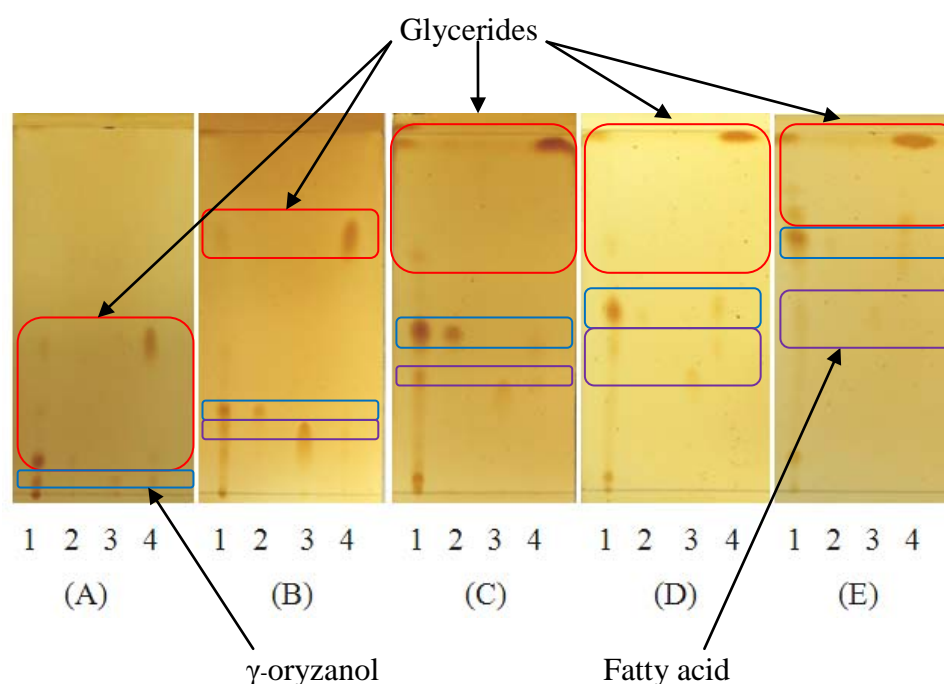
Component	Extract of saponified soapstock (original soapstock)	Extract of hydrolyzed acid oil (original acid oil)
$\gamma$ -oryzanol content (% wt)	4.07 (6.73)	5.38 (6.36)
Glycerides content (%wt)	0.57 (69.67)	0.87 (29.61)
Fatty acid content (% wt)	1.85 (3.53)	13.50 (7.69)

From the above results, the  $\gamma$ -oryzanol content remained in the extract of hydrolyzed acid oil was higher than that of acid oil since the loss in  $\gamma$ -oryzanol during the hydrolysis process was much lower. This was possibly due to the requirement of fewer steps required by hydrolysis and extraction of acid oil, compared with soapstock saponification which required an additional step to evaporate water from the saponified soapstock prior to extraction with ethyl acetate. Not only high loss was resulted, cost of water evaporation is usually high, and making soapstock not a

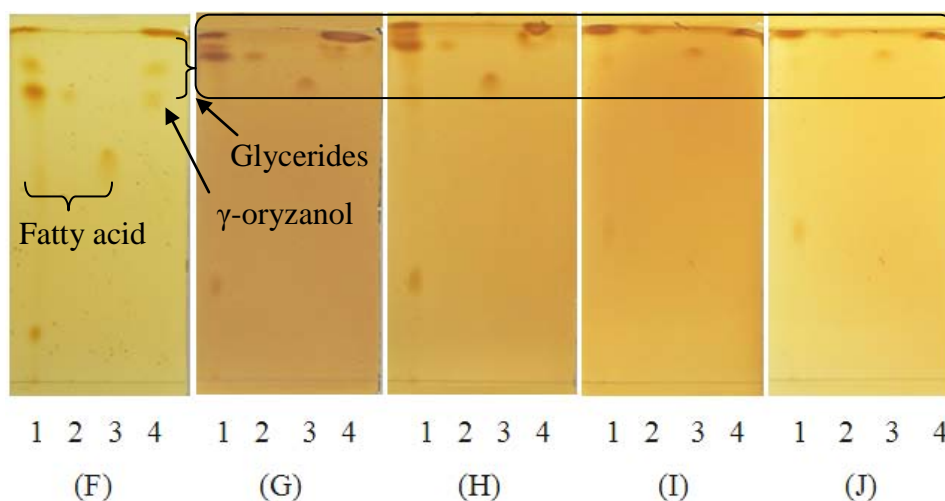
suitable raw materials for  $\gamma$ -oryzanol in an industrial scale. Furthermore, high water content of soapstock makes it easy to go rancid. Thus in this study, acid oil was chosen as a more suitable raw materials for further purification step. Chromatography would be employed as a purification technique and as the first step, a suitable mobile phase for chromatography was determined base on a TLC study.

### 4.3 Thin-layer chromatography (TLC)

Thin-layer chromatography was employed as a quick and easy means to find the suitable mobile phase mixtures for separating and purifying  $\gamma$ -oryzanol from the impurities. In this study, organic solvents which have a low-polar were used as a mobile phase. As hexane and ethyl acetate mixture are most commonly employed mobile phase in normal-phase chromatographic separations of various natural compounds, it was employed in this study. In this study, ten compositions of the hexane and ethyl acetate mixture (95:5 v/v, 90:10 v/v, 85:15 v/v, 80:20 v/v, 75:25 v/v, 70:30 v/v, 65:35 v/v, 60:40 v/v, 55:45 v/v and 50:50 v/v) were investigated on aluminum TLC plates coated with silica gel as a stationary phase. The TLC results are shown Figure 4.7.







**Figure 4.7** The TLC plates of 1. Hydrolyzed acid oil extract, 2.  $\gamma$ -oryzanol standard, 3. Fatty acid standard (oleic acid) and 4. Glycerides standard (rice bran oil) at with various compositions of the hexane and ethyl acetate mixture: (A) 95:5 v/v, (B) 90:10 v/v, (C) 85:15 v/v, (D) 80:20 v/v, (E) 75:25 v/v, (F) 70:30 v/v, (G) 65:35 v/v, (H) 60:40 v/v, (I) 55:45 v/v and (J) 50:50 v/v

In Figure 4.7, the hydrolyzed acid oil extract (1) was spotted on a TLC plate against the standards of  $\gamma$ -oryzanol (2), fatty acid standard (3) and glycerides (4). The results in this figure indicated that hydrolyzed acid oil extract contains  $\gamma$ -oryzanol and other impurities including glycerides and fatty acid. The components in the sample were eluted at different rates depending on the partition coefficient of each component between the stationary phase and the mobile phase.

When the solvent mixture with high content of hexane (as in the case for 95:5 v/v and 90:10 v/v hexane: ethyl acetate mixtures, as shown in Figure 4.7 (A) and (B),  $\gamma$ -oryzanol and glycerides only slightly moved up the plates, while fatty acid, the more polar component was hardly eluted by the mobile phase, but rather remained attached to the polar silica gel stationary phase.

Since  $\gamma$ -oryzanol likes to dissolve in ethyl acetate (Raj R Kumar et al., 2007), therefore at the higher ratio of ethyl acetate, the  $\gamma$ -oryzanol solubility in the mobile phase became increased, all the components tended to move farther up the TLC plates, and clearer separation of these components could be observed on the plate, until up to 65:35 v/v hexane: ethyl acetate ratio. When the mobile phase contained too

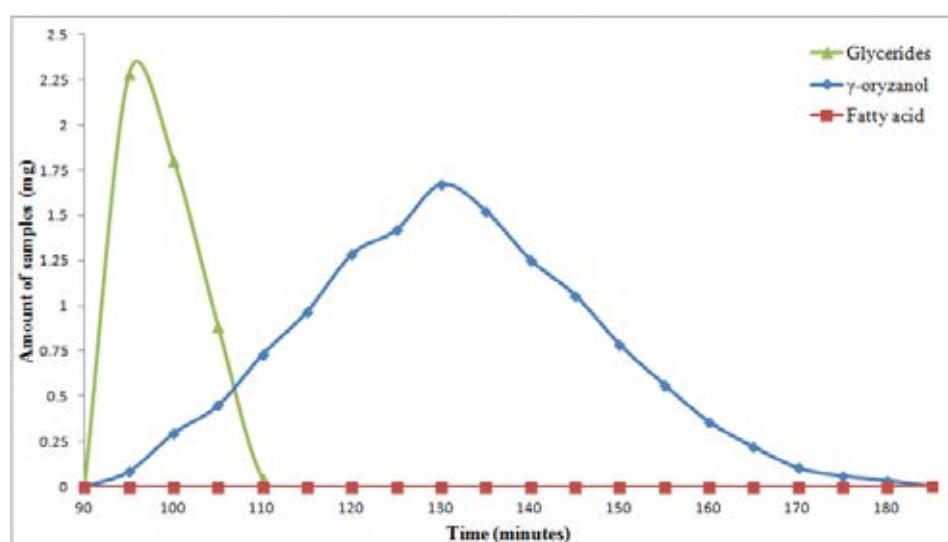
high amount of ethyl acetate on the other hand, all components moved quickly to the top of the plates and poor separations were resulted. Although when eluted with 85:15 v/v ratio of hexane and ethyl acetate phase (Figure 4.7 C),  $\gamma$ -oryzanol seemed to be clearly separate from glycerides and fatty acid, at this ratio,  $\gamma$ -oryzanol took longer to move through the TLC plate than with the mobile phase of higher volume ratio of ethyl acetate. While at 75:25 v/v ratio of hexane-to-ethyl acetate (Figure 4.7 E), separation between  $\gamma$ -oryzanol and glycerides and fatty acid was reasonably seen, but with the retention time that was much shorter. Furthermore, the location of the  $\gamma$ -oryzanol spot on the TLC at this ratio corresponds to the  $R_f$  value (a retention factor used for measuring the distance of component spots relate to the distance of the eluent) of about 0.6, which is recommended as a suitable  $R_f$  value for the component of interest for the selection of suitable mobile phase by TLC. As a rule of thumb, the  $R_f$  of the interested component on TLC plate should have in the range of 0.2 and 0.8. If  $R_f$  is below 0.2, the component moves too slowly through the plate, resulting in long retention time. If  $R_f$  is more than 0.8, the component moves too quickly resulting in poor product separation. To confirm the suitable selection of the mobile phase, both 85:15 v/v and 75:25 v/v hexane and ethyl acetate mixtures were tested on the semi-preparative column (10 g of silica gel, 25-40  $\mu$ m). With the mobile phase at the ratio 85:15 v/v of hexane and ethyl acetate, it took much longer time to elute  $\gamma$ -oryzanol from the column (235-465 min), compared with that of 75:25 v/v of hexane and ethyl acetate ratio (90-185 min) 135 minutes eluting  $\gamma$ -oryzanol from the column. Thus, the hexane to ethyl acetate at 75:25 v/v ratio was selected as an appropriate mobile phase for purification of  $\gamma$ -oryzanol. This mobile phase composition was employed in subsequent experiments to determine the effect of operational variables on the performance of the chromatographic column.

#### **4.4 Semi-preparative column chromatography**

Semi-preparative scale chromatography is employed in this part to purify  $\gamma$ -oryzanol from hydrolyzed acid oil extract. The effects of the amount of silica gel and particle size of silica gel as well as the effects of two elution modes (isocratic and gradient) on the performance of column chromatography were determined. As a suitable mobile phase for the elution of the compound mixtures on TLC plates coated

with silica gel, hexane to ethyl acetate mixture at the ratio of 75:25 v/v was used as a mobile phase in this study, in which the normal phase semi-preparative column chromatography was examined. The fractions were collected at every 5 minutes interval and were analyzed using a reverse phase high performance liquid chromatography (RP-HPLC) equipped with ELSD detector. The %purity in this study was determined from %area under peak chromatogram of  $\gamma$ -oryzanol. The %yield was reported based on the amount of  $\gamma$ -oryzanol collected in all fractions whose purity was more than 95%.

As shown in the chromatogram of the behavior of three major components in hydrolyzed acid oil extract in Figure 4.8, three major components which were found in the hydrolyzed acid oil extract were glycerides, fatty acid and  $\gamma$ -oryzanol. The elution of the components occurred in the order of increasing polarity, thus glycerides were the first component to elute from the column due to their low polarity (similar to hexane). The second eluted component was  $\gamma$ -oryzanol which has moderate polarity (similar to ethyl acetate). On the other hand, fatty acids which have high polarity relative to the other two components seemed to stay in the column packed with polar stationary phase like silica gel. The effects of the amounts of silica gel packed, particle size and elution mode are shown in the subsequent sections.



**Figure 4.8** The behavior of three major components in hydrolyzed acid oil extract by using isocratic elution mode (Hexane to ethyl acetate 75:25 v/v)

#### 4.4.1 Effect of the amount of silica gel packed in a semi-preparative column chromatography on %yield and %purity of $\gamma$ -oryzanol

In this part, 1 ml hydrolyzed acid oil extract containing approximately 55% purity of  $\gamma$ -oryzanol based on %area under peak chromatogram was loaded into a semi-preparative glass chromatography columns packed with various amounts of silica gel (5 g, 10 g and 15 g) of the same particle size (25-40  $\mu$ m). The loaded sample was then eluted with hexane and ethyl acetate mixture at a ratio of 75:25 v/v in an isocratic mode. Each fraction was collected every 5 minutes and analyzed. The results were shown in Table 4.4.

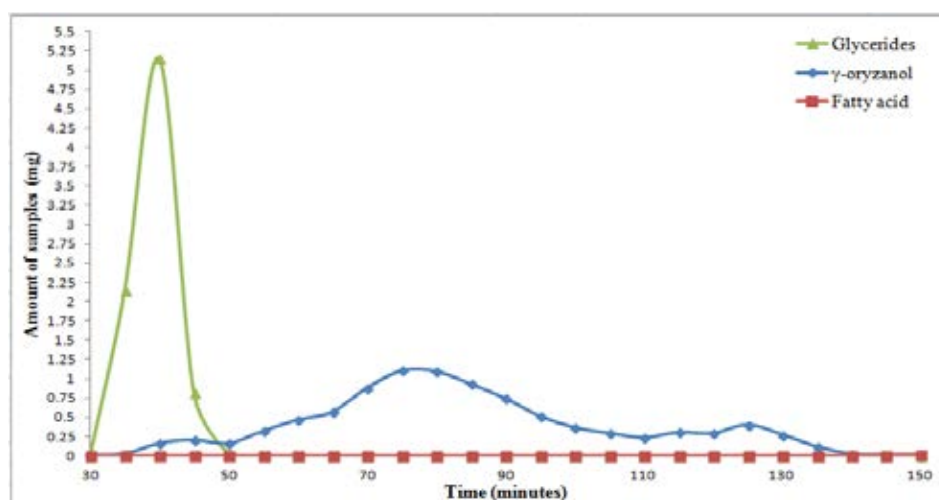
**Table 4.4** The results at different amounts of silica gel packed

Amount of silica gel packed (g)	Flow rate (ml/min)	Retention time of $\gamma$ -oryzanol <sup>i</sup> (minute)	% Yield of $\gamma$ -oryzanol <sup>j</sup>	Resolution <sup>k</sup> ( $R_s$ )	% Recovery of $\gamma$ -oryzanol <sup>l</sup>
5	0.30	84.66	69.25	0.90	72.41
10	0.20	131.64	83.64	0.82	89.42
15	0.14	376.97	28.39	0.70	63.25

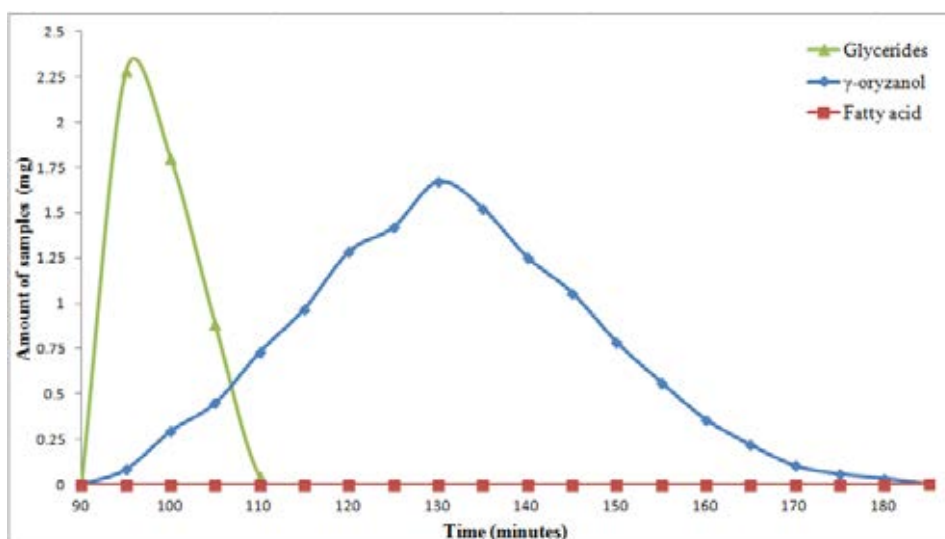
i see appendix D-4, j see appendix D-2, k see appendix D-6 and l see appendix D-2

Different amount of silica gel packed means different column height. At the same flow rate, the column packed with high amount of silica gel should result in clearest separation of the components in the mixture because long column provide higher number of plates, this giving high resolution and  $\gamma$ -oryzanol yield. However, in this study flow rate of the column was not controlled but affected by gravitational force which in turn is related to the length of the column. This in turn may affect the column performance. The highest flow of 0.3 ml/min was observed for the column packed with the smallest amount of silica gel (5 g). And since the column was the shortest the retention time was also the shortest in this case. With this amount of silica gel packed, the result in Table 4.6 shows that only about 70% yield of  $\gamma$ -oryzanol could be achieved. Due to the short time spent and the short column length, partitioning of the compound on the column might have not taken place effectively.

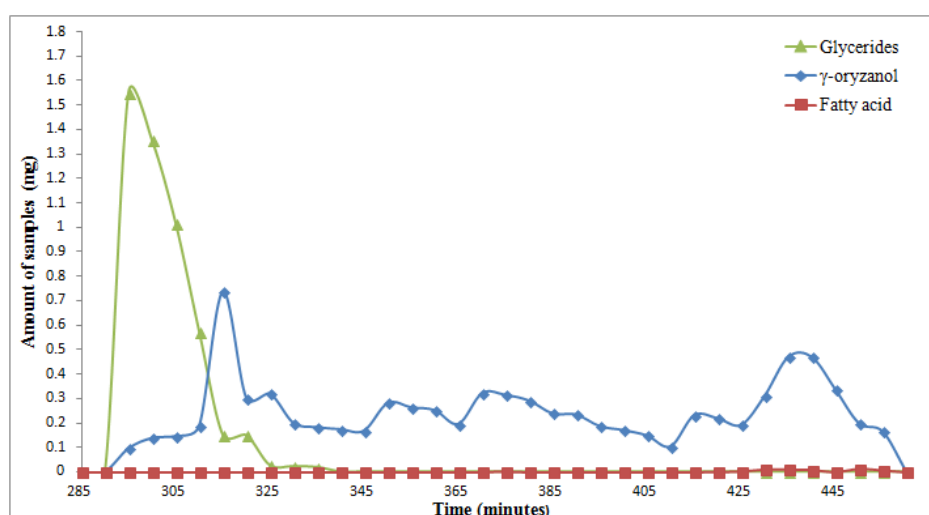
Moreover, the process for eluting was stopped before all  $\gamma$ -oryzanol loaded could be removed from the column. This resulted in lower  $\gamma$ -oryzanol recovery (only 72%) than what would be expected, which then leads to the relatively low yield. The column packed with 15 g of silica gel provided the lowest yield of  $\gamma$ -oryzanol (28.39%). This amount of silica gel gave very low flow rate, thus causing extremely long time for the compounds to elute. In addition, such low flow resulted in high peak broadening which then resulted in poor resolution between  $\gamma$ -oryzanol and glycerides. In addition, due to long distance it needed to travel through the column and extremely slow flow rate, a large amount  $\gamma$ -oryzanol still remained on the column and not recovered. This amount of silica gel was therefore not suitable for preparative separation and purification of  $\gamma$ -oryzanol by column chromatography. The column packed with 10 g of silica gel was the most efficiency for separation of  $\gamma$ -oryzanol from other impurities. The condition provides the highest recovery and yield of  $\gamma$ -oryzanol which were approximately 89.42% and 83.64 %, respectively. Moreover, sharper peak of  $\gamma$ -oryzanol were observed compared with those eluted from the column packed with 5 or 15 g of silica gel.



(A)



(B)



(C)

**Figure 4.9** The amount of components sample at various amount of silica gel packed by using isocratic elution mode (Hexane to ethyl acetate 75:25 v/v); (A) 5 g, (B) 10 g and (C) 15 g

From the above results, packing 10 g of silica gel in the column resulted in the highest yield of  $\gamma$ -oryzanol (whose purity was higher than 95%). This amount was therefore used in the subsequent study in which the effect of particle size of silica gel in the column was determined on the column performance.

#### 4.4.2 Effect of the particle size of silica gel packed in a semi-preparative column chromatography on %yield and %purity of $\gamma$ -oryzanol

In this part, 1 ml of the hydrolyzed acid oil sample containing about 55% oryzanol was loaded on to the semi-preparative glass column chromatography packed with 10 g of silica gel. The effect of particle sizes of silica gel (15-25  $\mu\text{m}$ , 25-40  $\mu\text{m}$  and 40-63  $\mu\text{m}$ ) were determined on chromatography carried out with an with isocratic mode using 75:25 v/v hexane to ethyl acetate mixture as a mobile phase. Each fraction was collected every 5 minutes and was then analyzed. The results are summarized in Table 4.5.

**Table 4.5** Summary different particle sizes of silica gel packed

Size of silica gel packed ( $\mu\text{m}$ )	Flow rate (ml/min)	Retention time of $\gamma$ -oryzanol <sup>m</sup> (minute)	% Yield of $\gamma$ -oryzanol <sup>n</sup>	Resolution <sup>o</sup> ( $R_s$ )	% Recovery of $\gamma$ -oryzanol <sup>p</sup>
15-25	0.16	327.57	49.77	1.80	50.36
25-40	0.20	131.64	83.64	0.82	89.42
40-63	1.00	44.12	60.37	0.82	63.67

m see appendix D-4, n see appendix D-2, o see appendix D-6 and p see appendix D-2

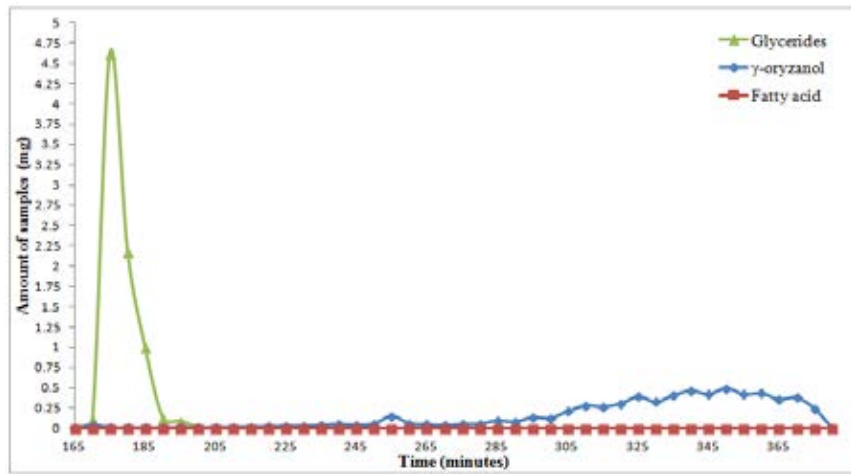
The results for  $\gamma$ -oryzanol yield obtained from column packed with silica gel of various particle sizes along with other information such as flow rate, resolution, retention time, and etc is summarized in Table 4.7. The corresponding chromatograms of eluted compounds through the column are shown in Figure 4.10. The particle sizes of packing materials have an effect on the column efficiency. Given the same mobile phase flow rate, the small particle (15-25  $\mu\text{m}$ ) should provide good separation between the components due to higher outer adsorption surface areas available for partitioning of each component between stationary phase and mobile phase. In addition, the resistance to intraparticle diffusion through the pore was also smaller with small particles. However, in this study, the mobile phase flow down the column only under the influence of gravity, the size of the silica gel particles therefore considerably affect the mobile phase flow rate. The smallest size silica gel (15-25  $\mu\text{m}$ )

could provide high pressure drop across the column resulted in very low mobile phase flow rate. At such low flow, the compounds retained in the column for a longer period and thus caused long retention time. In addition, peak broadening occurred as a result of high axial dispersion. Despite the broad peaks, the resolution for the  $\gamma$ -oryzanol and glycerides peak were high. This was possibly due to the fact that the compounds retained on the column for a long time, thus allowing enough time for the two peaks to separate. Nevertheless, the yield of  $\gamma$ -oryzanol (at purity >95%) was low (49.77 %). Considering the total amount of  $\gamma$ -oryzanol, only 50.36% of that loaded to the column were eluted down the column. There was still a large quantity remained on the column. Extremely low flow rates may not effectively elute this amount of  $\gamma$ -oryzanol down the column.

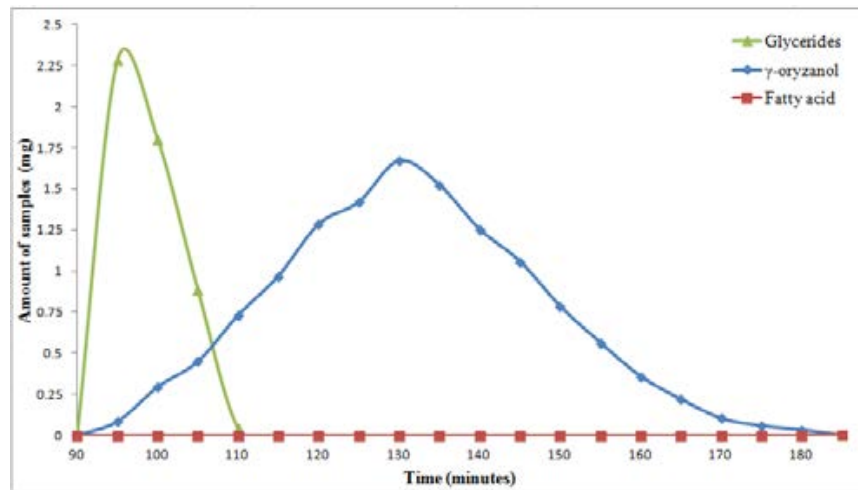
When the particle size of silica gel was large (40-63  $\mu\text{m}$ ), larger spaces between each particle therefore resulted in very high mobile phase flow rate through the column. When the flow rate was too high however,  $\gamma$ -oryzanol may not have enough time to partition onto the adsorbent, but instead passed through the spaces between the particles. The retention time for the  $\gamma$ -oryzanol was only 44.12 minutes. The separation was then stopped not long after this period. Nevertheless, in this case, a certain amount of  $\gamma$ -oryzanol (approximately 40%) was still adsorbed on the column, and not being eluted out, thus resulting in a low  $\gamma$ -oryzanol yield.

At moderate particle size of 25-40  $\mu\text{m}$ , the highest yield was achieved (83.64 %) and the corresponding value of recovery of  $\gamma$ -oryzanol was approximately 89.42 %. It was possible that this size gave the optimum flow rate range, which provides high column efficiency as well as provides enough time for the compounds to separate and eluted down the column.

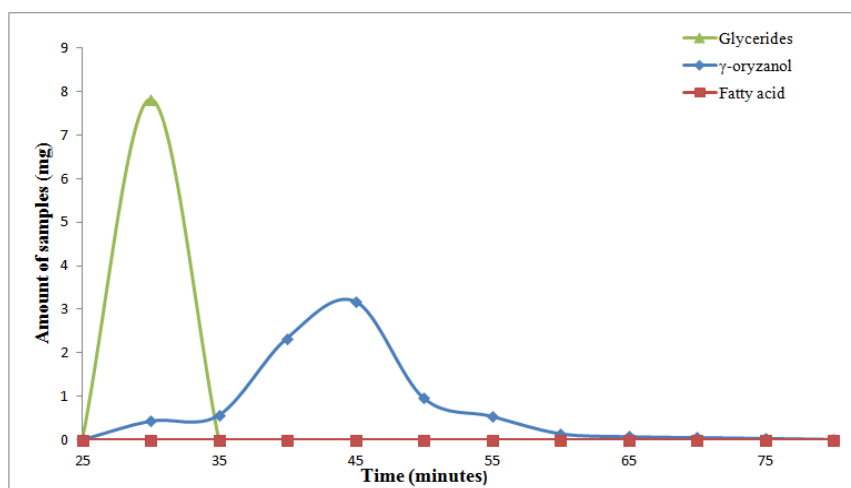




(A)



(B)



(C)

**Figure 4.10** The amount of components sample at different particle size of silica gel packed by using isocratic elution mode (Hexane to ethyl acetate 75:25 v/v); (A) 15-25  $\mu\text{m}$ , (B) 25-40  $\mu\text{m}$  and (C) 40-63  $\mu\text{m}$

From the above results, silica gel whose size was 25-40  $\mu\text{m}$  gave approximately 83.64%, which was the highest yield of  $\gamma$ -oryzanol (at >95% purity). Thus, in the following experiment, the evaluation of elution modes (isocratic versus gradient) would be conducted employing a semi-preparative column packed with 10 g of 25-40  $\mu\text{m}$  silica gel.

#### **4.4.3 Effect of elution mode between isocratic elution mode and gradient elution mode on %yield and %purity of $\gamma$ -oryzanol**

In the proceeding experiments, isocratic mode was employed for elution of the sample mixture down the semi-preparative column. The highest yield with isocratic mode was found to be 83.64%. This was achieved when at the most suitable amount (10 g) and particle size of silica gel (25-40  $\mu\text{m}$ ) determined previously. Based on the chromatogram in Figure 4.11 (A), the glycerides and  $\gamma$ -oryzanol peaks are overlapping, which limit the recovery of high purity  $\gamma$ -oryzanol at higher yield. With the isocratic mode with the most suitable conditions, the peak resolution was still only 0.82. Gradient mode was therefore employed in attempt to improve the resolution, and thus the yield and purity of the final product. The TLC results could suggest an appropriate gradient mode, which could possibly improve the performance of chromatography. From the TLC results in Figure 4.7(C), hexane to ethyl acetate at the ratio of 85:15 v/v allowed greater separation of glycerides and  $\gamma$ -oryzanol since non-polar glycerides moved quickly through the plate by the mobile phase containing high amount of non-polar solvent (hexane), where as  $\gamma$ -oryzanol stayed adsorbed on the silica gel stationary phase.

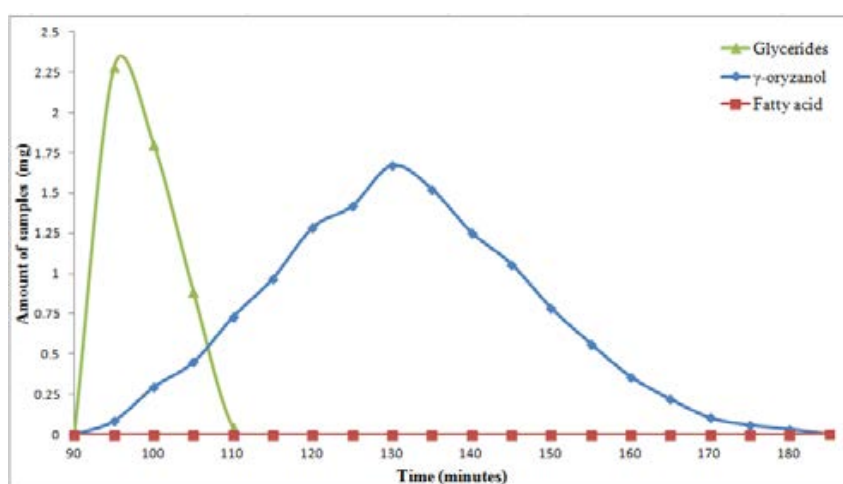
In this part, the step-gradient mode therefore began with elution with the hexane and ethyl acetate mixture at the ratio of 85:15 v/v for approximately 1 hour, followed by the elution with hexane and ethyl acetate mixture at 75:25 v/v to elute the  $\gamma$ -oryzanol from the column. The results are summarized in Table 4.6.

**Table 4.6** The summary of data experiment at two elution modes: isocratic and gradient elution mode

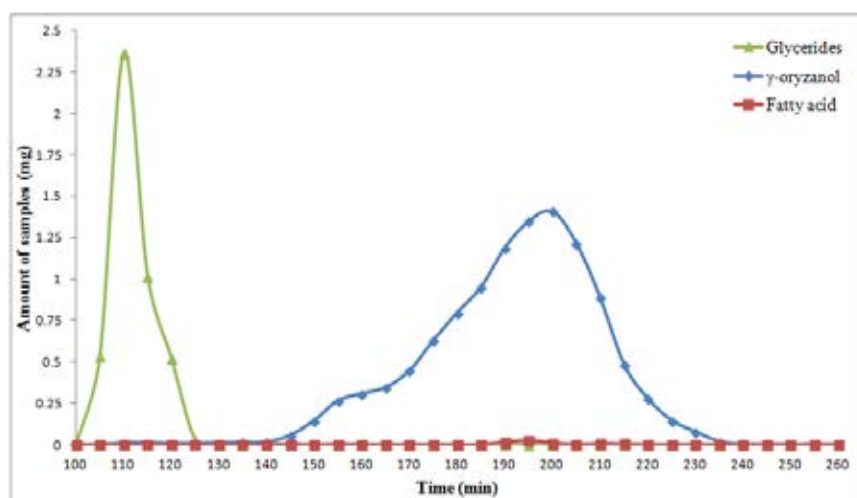
Elution mode	Flow rate (ml/min)	Retention time of $\gamma$ -oryzanol <sup>q</sup> (minute)	% Yield of $\gamma$ -oryzanol <sup>r</sup>	Resolution <sup>s</sup> ( $R_s$ )	% Recovery of $\gamma$ -oryzanol <sup>t</sup>
Isocratic	0.20	131.64	83.64	0.82	89.42
Gradient	0.20	191.27	90.15	1.77	90.49

<sup>q</sup> see appendix D-4, <sup>r</sup> see appendix D-2, <sup>s</sup> see appendix D-6 and <sup>t</sup> see appendix D-2

The chromatogram in Figure 4.11 indicated that while it is not possible with the isocratic elution (Figure 4.11 (A)), complete separation of  $\gamma$ -oryzanol from glycerides could be achieved with the gradient mode (Figure 4.11 (B)). The gradient mode could increase the  $R_s$  from 0.82 to 1.77. The improvement in the purity (from >95% to 100%) and the yield of  $\gamma$ -oryzanol (from 83.64% to 90.15%) could be achieved therefore with the expense of longer elution time and an additional elution step. The optimization of the process is needed further.



(A)



(B)

**Figure 4.11** The behavior of three major components at different elution mode by using silica gel 10 g, 25-40  $\mu\text{m}$  and 1 ml of injection sample; (A) isocratic mode and (B) gradient mode

## CHAPTER V

### CONCLUSIONS & RECOMMENDATIONS

#### 5.1 Conclusions

The objective of this study is to develop a procedure for purifying  $\gamma$ -oryzanol from extracted saponified soapstock or extracted hydrolyzed acid oil using normal phase chromatography and investigate the effects of operating variables on the yield and purity of  $\gamma$ -oryzanol. First, the suitability of soapstock and acid oil as raw materials for  $\gamma$ -oryzanol recovery was evaluated. The percent content of  $\gamma$ -oryzanol, percent loss of  $\gamma$ -oryzanol during glycerides removal step as well as the ease of extraction procedure were important criteria for the selection of suitable raw materials. The original soapstock was found to contain 5.40 %wt of  $\gamma$ -oryzanol based on wet basis (6.73% based on dry basis). After being saponified with 2.4 % of NaOH in methanol at 100 °C under constant stirring for 2 hours to convert glycerides into soap, the reaction product was dehydrated, and then extracted with ethyl acetate. The content of  $\gamma$ -oryzanol in this saponified extract was about 4.07% based on dry basis. The content of  $\gamma$ -oryzanol in the original acid oil was determined to be 6.28% based on wet basis (6.36% dry basis). After being hydrolyzed with aqueous solution of NaOH to get rid of glycerides, the hydrolyzed acid oil was then extracted with ethyl acetate. The content of  $\gamma$ -oryzanol in this hydrolyzed acid oil extract was found to be 5.38% based on dry basis. The  $\gamma$ -oryzanol content remained in the extract of hydrolyzed acid oil was higher than that of acid oil since the loss in  $\gamma$ -oryzanol during the hydrolysis process was much lower. This was possibly due to the requirement of fewer steps required by hydrolysis and extraction of acid oil, compared with soapstock saponification which required an additional step to evaporate water from the saponified soapstock prior to extraction with ethyl acetate. Not only high loss was resulted, cost of water evaporation is usually high, and making soapstock not a suitable raw materials for  $\gamma$ -oryzanol in an industrial scale. Furthermore, high water content of soapstock makes it easy to go rancid. Thus in this study, the extract of

hydrolyzed acid oil having about 55% purity of  $\gamma$ -oryzanol was then further purified with chromatography. Initially, TLC was employed as a preliminary test to determine the suitable mobile phase composition of hexane and ethyl acetate for further study in a semi-preparative column chromatography. The suitable mobile phase composition was found to be the hexane to ethyl acetate at 75:25 v/v ratio. This solvent was first used a semi-preparative column chromatography operated under the isocratic elution mode, in which the effects of the amount (5 g, 10 g, and 15 g) and particle size (15-25  $\mu\text{m}$ , 25-40  $\mu\text{m}$  and 40-63  $\mu\text{m}$ ) of silica gel packed in the column on the yield and purity of  $\gamma$ -oryzanol was determined. The results suggested that the semi-preparative column packed with 10 g of silica having 25-40  $\mu\text{m}$  particle size gave the highest yield (83.64%) of high purity (>95%)  $\gamma$ -oryzanol. The yield could be further increased to 90.15% by employing a gradient elution mode with 85:15 v/v of hexane and ethyl acetate mixture was used as a mobile phase in the first hour before it was switch to 75:25 v/v of hexane and ethyl acetate.

## 5.2 Recommendations

Recommendations for further study are as follow.

1. Attempts should be made to minimize the loss of  $\gamma$ -oryzanol during the saponification or hydrolysis steps by optimizing the saponification and hydrolysis process conditions.

2. Since free fatty acid content in acid oil was quite high. Although based on our results of this study, it can be separated completely from the  $\gamma$ -oryzanol, removing it a priori might simplify the purification process. Removal of free fatty acid from acid oil could be accomplished by distillation under high vacuum (Das et al., 1999).

3. The results in this study suggested that as high as 90% yield could be achieved by chromatography operated under gradient elution mode (85:15 v/v for 1 hour to 75:25 v/v of hexane and ethyl acetate). The enhancement in product yield was however with the expense of chromatography time, which in turn reduced the productivity. Optimization of the gradient mode process might be necessary and economic factors should also be taken in to considerations to verify the feasibility of the process for the industrial scale production. In the same front, considerations

should be given to the processes of mobile phase recovery and regeneration of silica gel stationary phase

## REFERENCES

- Office of agricultural economic. [Online]. 2012. Available from: <http://www.oae.go.th>  
[2012, November 1]
- Chromatography. [Online]. 2012. Available from: <http://www.chemistry.sc.chula.ac.th> [2012, November 8]
- Akiya, T. Components of Unsaponified Matter of the Rice Bran Oil. J. Agric Biol Chem 26 (1962) : 180-186.
- Amarasinghe, B. M. W. P. K. and Gangodavilage, N. C. Rice bran oil extraction in Sri Lanka Data for Process Equipment Design. Trans IChemE Part C Food Bioprod Process 82 (2004) : 54-59.
- Arumugan, C. Kumar, S., Rajam, L. and Sundaresan, A. Integrated technology for rice bran oil refining and by products recovery. SAARC Oils Fats Today (August 2003) : 10-14.
- Bhattacharya, A.C and Bhattacharya, D.K. Degumming of rice bran oil. J. Oil Technol Assoc India 17 (1985) : 27-30.
- Bonner, B., Warren, B. and Bucci, L. Influence of ferulate supplementation on postexercise stress hormone levels after repeated exercise stress. J. Appl sports Sci Res 4 (1990) : 10.
- Cho, J.Y. et al. Quantitative analyses of individual gamma-oryzanol (Steryol Ferulates) in conventional and organic brown rice (*Oryza sativa* L.). J. of Cereal Sci 55 (2012) : 337-343.
- Das, P.K., Chaudhuri, A., Kaimal, T.N.B. and Bhalerao, U.T. Isolation of gamma-oryzanol through calcium ion induced precipitation of anionic micellar aggregates. J. Agric Food Chem 46 (August 1998) : 3073-3080.



- Das et al. Process for the Isolation of Oryzanols from Crude Dark Acid Oil (Rice Bran) U.S. Patent 5869708 (1999).
- Ghosh, M. Review on Recent Trends in Rice Bran Oil Processing. J. Am Oil Chem Soc 84 (2007) : 315-324.
- Gingras, L. Refining of Rice Bran Oil. inform 11 (2000) : 1196-1203.
- Gibon, V. and Tirtaux, G. Removal of gums and waxes-A review. inform 11 (2000) : 524-535.
- Gopalakrishna, A. G. Value-added Products from Rice Bran Oil Industry. SAARC Oils Fats Today (August 2003) : 20-23.
- Guhe, V. D. and Bhowmick, D. N. Evidence of maillard reaction in darkening of rice bran oil. J. Oil Technol Assoc India 30 (1998) : 117-120.
- Hayafune, K. and B. Sato. Puff cream, Chou crème confectionary and production thereof. Japanese patent JP02255037 A2 (1990).
- Huang, D., M. Hampsch-Woodill, J. Flanagan, and K. Deemer. Development and validation of oxygen radical absorbance capacity assay for lipophilic antioxidant using randomly methylated  $\beta$ -cyclodextrin as the solubility enhancer. J. of agricultural and food chemistry 50 (2002) : 1815-1821.
- Hu, W., Well, J. H., Shin, T. and Gober, J.S. Comparison of isopropanol and hexane for extraction of vitamin E and oryzanol from stabilized rice bran. J. Am Oil Chem Soc 73 (1996) : 1635-1656.
- Indira, T.N., Narayan, A.V., Barhate, R.S., Raghavarao, K.S.M.S., Khatoon, S., Channaiah, G., Rao, A.R.G.R.A. and V. Prakash. Process for the Production of Oryzanol Enriched Fraction from Rice Bran Oil Soapstock. US Patent 6896911 B2 (2005).
- Issara Sereewatthanawut, Surawit Prapintip, Katemanee Watchirarujji, Goto, M., Sasaki, M. and Artiwan Shotipruk. Extraction of protein and amino acids from

- deoiled rice bran by subcritical water hydrolysis. Bioresource Technology 99 (2008) : 555-561.
- Ito, K. and Hotta, Y. Proliferation pattern of postembryonic neuroblasts in the brain of *Drosophila melanogaster*. Dev Biol 149 (1992) : 134–148.
- Jesusa, S.P., Grimaldi, R. and Hensea, H. Recovery of  $\gamma$ -oryzanol from rice bran oil byproduct using supercritical fluid extraction. J. of Supercritical Fluids 55 (2010) : 149-155.
- Johnson, L. A. and Lusas, E. W. Comparison of alternative solvents for oils extraction. J Am Oil Chem Soc 60 (February 1983) : 229-242.
- Kaimal, T. B. N.  $\gamma$ -oryzanol from rice bran oil. J. Oil Technol Aassoc India 31 (1999) : 83-93.
- Kaimal, T. B. N. Origin of problems encountered in rice bran oil processing. Eur J. Lipid Sci Technol 104 (April 2002) : 203–211.
- Kaneko, R. and Tsuchiya, T. New compound in rice bran and germ oils. J. Chem Soc Jpn 57 (1954) : 526.
- Kochhar, S.P. Influence of processing on sterols of edible vegetable oils, Prog Lipid Res 22 (1983) : 161-188.
- Krishna, A.G.G., Prashanth, P.A., Pragasam, A., Raghavendra, K.V. and Khatoon, S. Unsaponifiable matter and oxidative stability of commercially produced indian rice bran oils. J. of Food Lipids 10 (2003) : 329-340.
- Kumar, R. R., Tiku, P. K. and Prakash, V. Preferential extractability of  $\gamma$ -oryzanol from dried soapstock using different solvents. J. Sci Food Agric 89 (2009) : 195-200.
- Kuroda, N., Ohnishi, M. and Fujino, Y. Sterol Lipids in Rice Bran. Cereal Chem 54 (1977) : 997-1006.

- Lai, S. M., Hesieh, H. L. and Chang, C.W. Preparative separation of  $\gamma$ -oryzanol from rice bran oil by silica gel column chromatography. J. of Liquid Chromatography & Related Technologies 28 (2005): 145-160.
- Minami, N. and Motito, B. Condition for using  $\gamma$ -oryzanol and its utilization in food. New food studies 24 (1982) : 49-53.
- Murase, Y. and Lishima, H. Clinical studies of oral administration of gamma-oryzanol on climacteric complaints and its syndrome. Obstel Gynecol Prac 12 (1963) : 147-149.
- Nagahara, A. Tool for preventing growth of weed. Japanese patent JP08232229 A2 (1996).
- Nattawuth Kittiruangthong. Extraction and Purification of gamma-oryzanol from rice bran oil soap stock and acid oil. Master's Thesis Biochemical Technology, Department of Biochemical Technology, Faculty of School of Bioresources and Technology, King Mongkut's University of Technology Thonburi, 2005.
- Narayan, A.V., Barhate, R.S. and K.S.M.S. Raghavarao. Extraction and purification of oryzanol from rice bran oil and rice bran oil soapstock. J. Am Oil Chem Soc 83 (2006) : 663-670.
- Narayan, A.V., Barhate, R.S., Indira, T.N., Raghavarao K.S.M.S., Rao, A.R.G.R.A. and V. Prakash. Process for Crystallization of Oryzanol from Oryzanol Enriched Fraction Derived from Rice Bran Oil Soapstock. WO 055040 A1 (2004).
- Patel, M. and Naik, S.N. Gamma-oryzanol from rice bran oil-A review. J. Scientific & Industrial Research 63 (2004) : 569-578.
- Perretti, G., Miniati, E., Montanari, L. and Fantozzi, P. Improving the value of rice (*Oryza sativa* L.) by-products by SFE. J. of Supercritical Fluids 26 (2003) : 63-71.

- Pillaiyar, P. Problems facing rice bran oil extraction in Indian. Oil Oil Seeds J 32 (1980) : 16-18.
- Rao, K.V.S.A., Rao, B.V.S.K. and T.N.B. Kaimal. Process for the Isolation of Oryzanols from Rice Bran Oil Soapstock. U.S. Patent 6410762 (2002).
- Rogers, E.J., Rice, S.M., Nicolosi, R.J., Carpenter, D.R., McClelland, C.A. and Romanczyk, L.J.Jr. Identification and quantitation of  $\gamma$ -oryzanol components and simultaneous assessment of tocopherols in rice bran oil. J. Am Oil Chem Soc 70 (March 1993) : 301-307.
- Sakada, Hideharu; JP 82.32.229 (1982)
- Saska, M. and Rossiter, G.J. Recovery of  $\gamma$ -oryzanol from rice bran oil with silica-based continuous chromatography. J. Am Oil Chem Soc 75 (1998) : 1421-1427.
- Seetharamajah, G.S., Krishnakantha, T.P. and Chandrasekhara, N. Influence of oryzanol on platelet aggregation in rats. J. Nutr Sci Vitaminol 36 (1990):291-297.
- Seetharamajah, G.S. and Prabhaker, J. V. Oryzanol content of Indian rice bran oil and its extraction from soap stock. J. Food Sci and Technol 23 (1989) : 270-273.
- Tsushimoto, G., T. Shibahara, T. Awogi, E. Kaneno, S. Sotou, K. Yamamoto, and H. Shirakawa, DNA-Damaging, Mutagenic, Clastogenic and Cell-Cell Communication Inhibitor Properties of Gamma-Oryzanol. J. Toxicology Science 16 (1991) : 191-202.
- Wasinee Kaewboonnum. Separation of gamma oryzanol from soapstock by product from rice bran oil industry Master's Thesis Chemical Engineering, Department of Chemical Engineering, Faculty of Engineering, Chulalongkorn University, 2007.

- Xu, Z. and Godber, J.S. Purification and Identification of Components of  $\gamma$ -Oryzanol in Rice Bran Oil. J. Agric Food Chem 47 (July 1999) : 2724-2728.
- Xu, Z. and Godber, J.S. Antioxidant Activities of Major Components of  $\gamma$ -Oryzanol from Rice Bran Using a Linoleic Acid Model. J. Am Oil Chem Soc 78 (June 2001) : 465-469.
- Xu, Z., Hua, N. and Godber, J.S. Antioxidant activity of tocopherols, tocotrienols and gamma-oryzanol components from rice bran against cholesterol oxidation accelerated by 2,2'-azobis(2-methylpropionamide) dihydrochloride. J. Agric Food Chem 49 (April 2001) : 2077-2081.
- Yoshino, G., T. Kazumi and M. Amano. Effects of  $\gamma$ -oryzanol and probucol on hyperlipidemia. Curr. Ther. Res 45 (1989) : 975-982.
- Zullaikah, S., Melwita, E. and Ju, Y.H. Isolation of oryzanol from crude rice bran oil. Bioresource Technology 100 (January 2009) : 299-302.

## **APPENDICES**

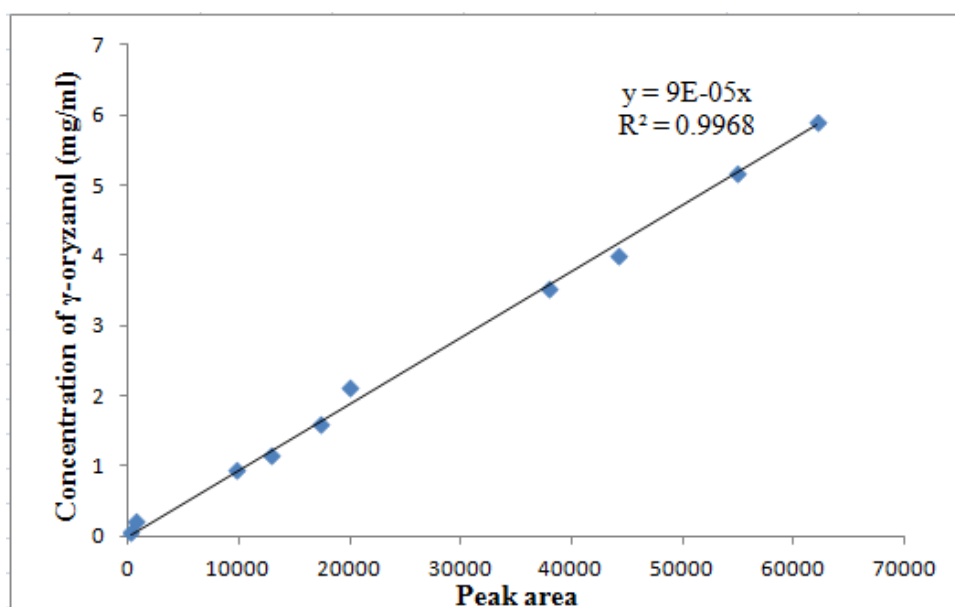
## APPENDIX A

### EXPERIMENTAL DATA FOR ANALYSIS

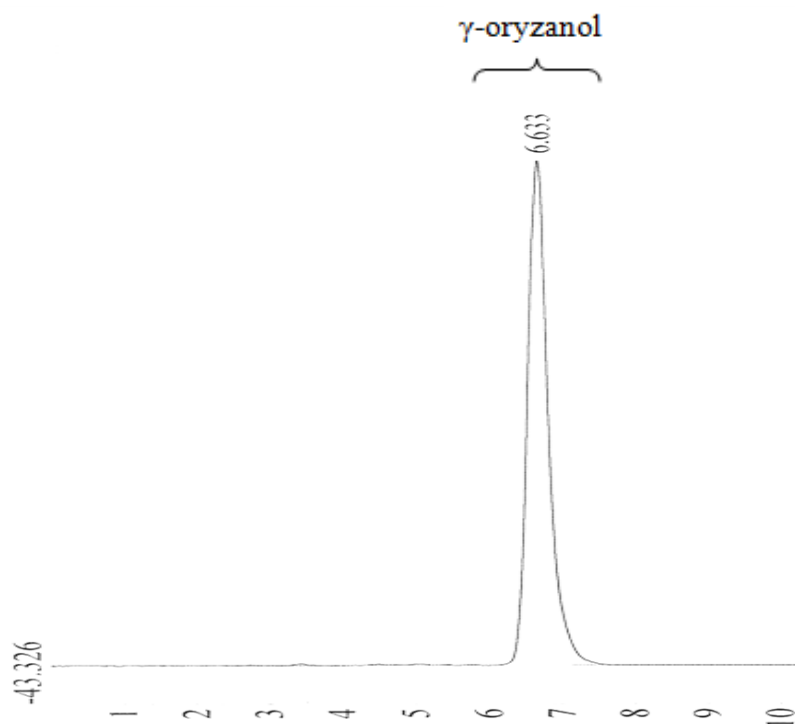
#### A-1 Standard calibration curve of $\gamma$ -oryzanol HPLC analysis

**Table A-1** Standard calibration curve of  $\gamma$ -oryzanol HPLC analysis

Concentration of $\gamma$ -oryzanol (mg/ml)	Peak area
0.064	279.000
0.236	754.123
0.960	9781.363
1.152	12881.593
1.600	17373.227
2.124	19893.604
3.540	37858.017
4.012	44210.617
5.192	54966.538
5.900	62166.083



**Figure A-1.1** Standard calibration curve of  $\gamma$ -oryzanol standard analyzed by HPLC



**Figure A-1.2** Chromatogram of  $\gamma$ -oryzanol standard

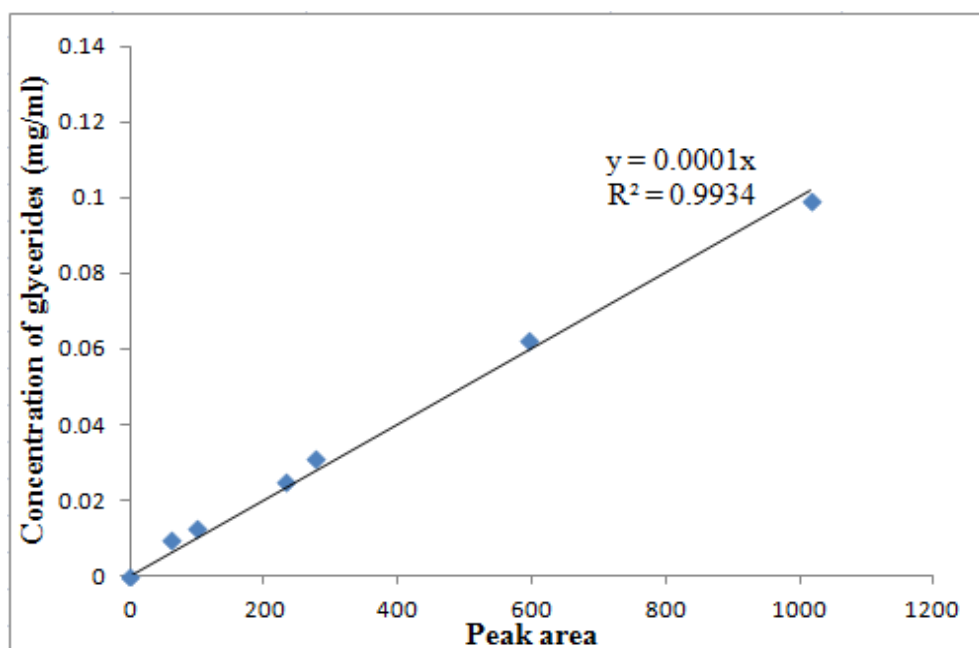
#### A-2 Standard calibration curve of glycerides HPLC analysis

**Table A-2** Standard calibration curve of glycerides HPLC analysis

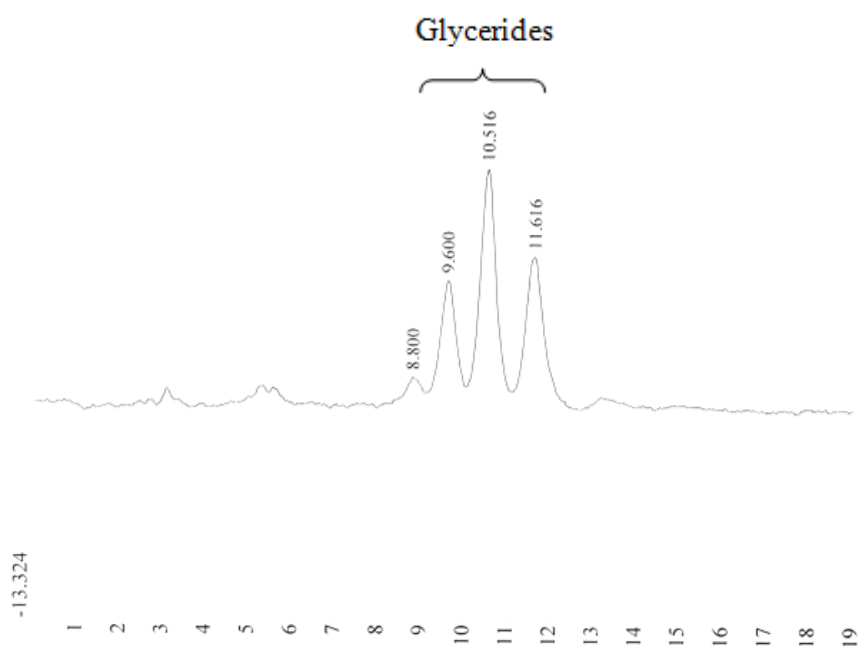
Concentration of Glycerides (mg/ml)	Peak area *
3053.175	61.064
4910.900	98.218
11634.200	232.684
13748.325	274.967
29735.350	594.707
50848.000	1016.960

\*Peak area of glycerides was calculated from the four main peaks appeared in Figure A-2.2





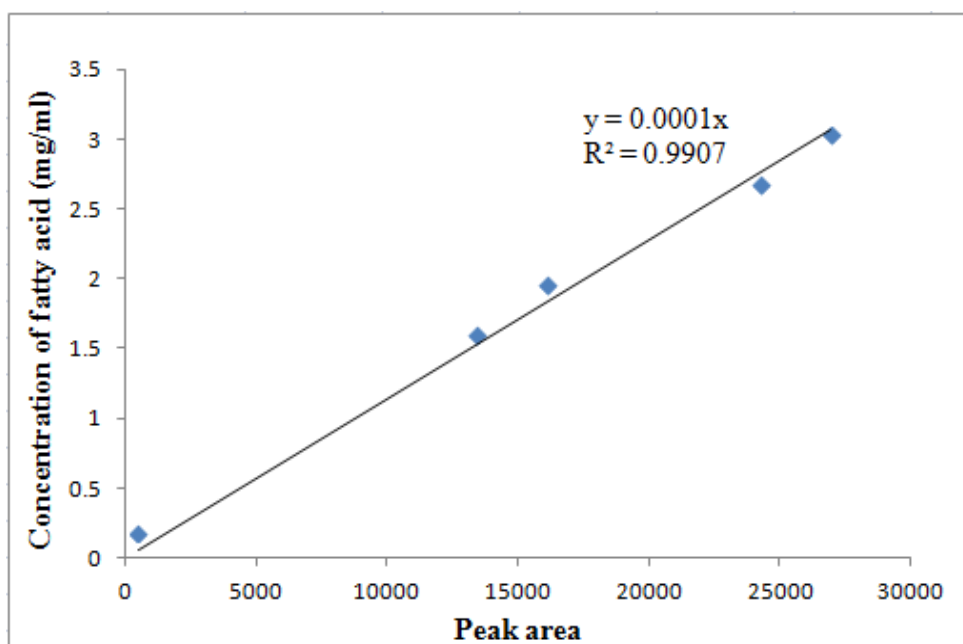
**Figure A-2.1** Standard calibration curve of glycerides standard analyzed by HPLC

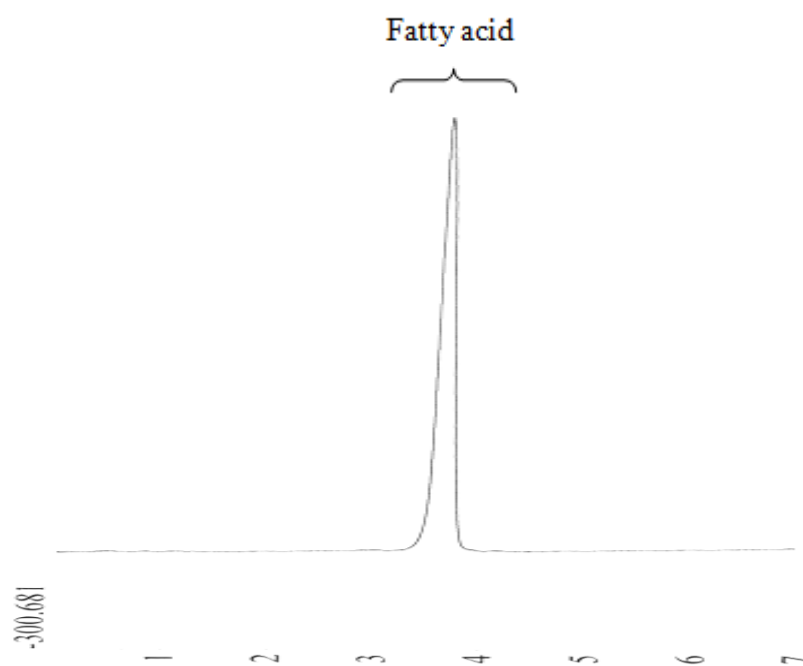


**Figure A-2.2** Chromatogram of glycerides standard

**A-3 Standard calibration curve of fatty acid HPLC analysis****Table A-3** Standard calibration curve of fatty acid HPLC analysis

Concentration of fatty acid (mg/ml)	Peak area
0.178	486.472
1.602	13417.435
1.958	16125.148
2.670	24268.698
3.026	26955.220

**Figure A-3.1** Standard calibration curve of fatty acid standard analyzed by HPLC



**Figure A-3.2** Chromatogram of fatty acid standard

## APPENDIX B

### EXPERIMENTAL DATA OF PROPERTIES OF SOAPSTOCK AND ACID OIL

#### B-1 Moisture content of soapstock

**Table B-1** Moisture content data of soapstock

Sample	Weigh of sample (g)	Weigh of sample after drying (g)	Moisture content (%)
1	30.30	22.98	24.15
2	33.46	25.09	25.04
3	32.30	24.48	24.29
Average	32.02	24.18	24.49

## APPENDIX C

### CONTENT CALCULATION

#### C-1 $\gamma$ -oryzanol content in soapstock extract

$\gamma$ -oryzanol content in original soapstock sample can be calculated as follow:  
The extract of original soapstock was analyzed  $\gamma$ -oryzanol by using RP-HPLC with ELSD detector. The experiment was used 3 g of dried soapstock for extraction with 200 ml of ethyl acetate. The results were found that the extract of  $\gamma$ -oryzanol from soapstock gave about 1.06 mg/ml and total volume of the extract was about 190 ml. Therefore, the total amount of  $\gamma$ -oryzanol that was found in the soapstock extract was about 201.8 mg.

%  $\gamma$ -oryzanol content (wet basis):

Moisture content of soapstock = 24.49 %wt

In this experiment, dried soapstock 3 g were used for extracting  $\gamma$ -oryzanol.

Thus, moisture content 100 %wt .....Dried saponified soapstock 3 g

moisture content 24.49 %wt.....Dried saponified soapstock 0.7347 g

$$\% \gamma\text{-oryzanol content (wet basis)} = \left( \frac{0.2018\text{g}}{3\text{g} + 0.7347\text{g}} \right) \times 100 = 5.40 \% \text{ wt}$$

%  $\gamma$ -oryzanol content (dry basis):

$$\% \gamma\text{-oryzanol content (dry basis)} = \left( \frac{0.2018\text{g}}{3\text{g}} \right) \times 100 = 6.73 \% \text{ wt}$$

#### C-2 Glycerides content in soapstock extract

The soapstock extract gave 11.02 mg/ml of glycerides. The total volume of the extract was about 190 ml. Thus, the total amount of glycerides in soapstock extract was about 2093.8 mg.

% glycerides content (wet basis):

$$\% \text{ glycerides content (wet basis)} = \left( \frac{2.09 \text{ g}}{3 \text{ g} + 0.7347 \text{ g}} \right) \times 100 = 55.96 \% \text{ wt}$$

% glycerides content (dry basis):

$$\% \text{ glycerides content (dry basis)} = \left( \frac{2.09 \text{ g}}{3 \text{ g}} \right) \times 100 = 69.67 \% \text{ wt}$$

### **C-3 Fatty acid content in soapstock extract**

The soapstock extract gave 0.56 mg/ml of fatty acid. The total volume of the extract was about 190 ml. Thus, the total amount of fatty acid in the soapstock extract was about 106.43 mg.

% Fatty acid content (wet basis):

$$\% \text{ Fatty acid content (wet basis)} = \left( \frac{0.106 \text{ g}}{3 \text{ g} + 0.7347 \text{ g}} \right) \times 100 = 2.84 \% \text{ wt}$$

% Fatty acid content (dry basis):

$$\% \text{ Fatty acid content (dry basis)} = \left( \frac{0.106 \text{ g}}{3 \text{ g}} \right) \times 100 = 3.53 \% \text{ wt}$$

### **C-4 $\gamma$ -oryzanol content in the extract of saponified soapstock extract**

The concentration of the saponified soapstock extract can calculate as follow: The experiment was used 15 g of dried saponified soapstock for extraction with 200 ml of ethyl acetate. The extract of saponified soapstock was analyzed by using RP-HPLC with ELSD detector. The results were found that the extract of saponified soapstock gave 3.83 mg/ml and total volume of the extract was about 155 ml. Thus, the total amount of  $\gamma$ -oryzanol was about 593.80 mg.

In this experiment after saponified soapstock extraction, the residue of saponified soapstock was extracted two times using 40 °C of sonication. The results were found that the first and the second sonication gave 10.97 mg and 5.51 mg of  $\gamma$ -oryzanol, respectively. The extracts were then combined in order to analyze the total amount of  $\gamma$ -oryzanol content in the extract of saponified soapstock using HPLC.

%  $\gamma$ -oryzanol content (wet basis):

Moisture content of soapstock = 24.49%

In this experiment, 15 g of dried saponified soapstock was used to extract  $\gamma$ -oryzanol with ethyl acetate.

Therefore, moisture content 100%.....Dried saponified soapstock 15 g

moisture content 24.49%.....Dried saponified soapstock 3.6735 g

%  $\gamma$ -oryzanol content (wet basis)

$$= \left( \frac{0.594g + 0.011g + 0.0055g}{15g + 3.6735g} \right) \times 100 = 3.27 \% \text{ wt}$$

%  $\gamma$ -oryzanol content (dry basis):

$$\% \gamma\text{-oryzanol content (dry basis)} = \left( \frac{0.594g + 0.011g + 0.0055g}{15g} \right) \times 100 = 4.07 \% \text{ wt}$$

### **C-5 Glycerides content in the extract of saponified soapstock extract**

The saponified soapstock extract gave 0.48 mg/ml of glycerides. The total volume of the extract was about 155 ml. Thus, the total amount of glycerides in the extract of saponified soapstock was about 74.40 mg.

In this experiment after saponified soapstock extraction, the residue of saponified soapstock was extracted two times using 40 °C of sonication. The results were found that the first and the second sonication gave 6.26 mg and 4.76 mg of glycerides, respectively.

% Glycerides content (wet basis):

$$\% \text{ Glycerides content (wet basis)} = \left( \frac{0.074g + 0.006g + 0.0476g}{15g + 3.6735g} \right) \times 100 = 0.46 \% \text{ wt}$$

% Glycerides content (dry basis):

$$\% \text{ Glycerides content (dry basis)} = \left( \frac{0.074 \text{ g} + 0.006 \text{ g} + 0.0476 \text{ g}}{15 \text{ g}} \right) \times 100 = 0.57 \% \text{ wt}$$

### **C-6 Fatty acid content in the extract of saponified soapstock extract**

The saponified soapstock extract gave 1.57 mg/ml of fatty acid. The total volume of the extract was about 155 ml. Thus, the total amount of fatty acid was 243.35 mg.

In this experiment after saponified soapstock extraction, the residue of saponified soapstock was extracted two times using 40 °C of sonication. The results were found that the first and the second sonication gave 26.2 mg and 11.9 mg of fatty acid, respectively.

% Fatty acid content (wet basis):

$$\% \text{ Fatty acid content (wet basis)} = \left( \frac{0.24 \text{ g} + 0.026 \text{ g} + 0.012 \text{ g}}{15 \text{ g} + 3.6735 \text{ g}} \right) \times 100 = 1.49 \% \text{ wt}$$

% Fatty acid content (dry basis):

$$\% \text{ Fatty acid content (dry basis)} = \left( \frac{0.24 \text{ g} + 0.026 \text{ g} + 0.012 \text{ g}}{15 \text{ g}} \right) \times 100 = 1.85 \% \text{ wt}$$

### **C-7 $\gamma$ -oryzanol loss in saponification step\***

Original soapstock sample	3	g
$\gamma$ -oryzanol in original soapstock sample	201.8	mg
Therefore, $\gamma$ -oryzanol in 1 g of original soapstock sample	67.27	mg

After saponification and dehydration step;

Dehydrated saponified soapstock	15	g
$\gamma$ -oryzanol in dehydrated saponified soapstock	593.8	mg
Therefore, $\gamma$ -oryzanol in 1 g of dehydrated saponified soapstock	39.59	mg



$$\gamma\text{-oryzanol loss in saponification step} \quad \left( \frac{67.27 - 39.59}{67.27} \right) \times 100 = 41.15 \%$$

\*The calculation was based on dry basis

### C-8 $\gamma$ -oryzanol content in acid oil extract

The concentration of the original acid oil extract can be calculated as follow: Acid oil 5 ml was used with 5 ml of ethyl acetate 5 ml for extraction in this experiment. The extract of original acid oil was analyzed by RP-HPLC. The results were found that the extract of original acid oil gave 1.15 mg/ml of  $\gamma$ -oryzanol and total volume of the extract was about 40 ml. Therefore, the total amount of  $\gamma$ -oryzanol was found 46 mg from 40 ml of the original acid oil extract. The extraction used 20 ml of acid oil.

%  $\gamma$ -oryzanol content (wet basis):

$$\begin{aligned} \text{\% } \gamma\text{-oryzanol content (wet basis)} &= \text{Grams of } \gamma\text{-oryzanol / milliliter of acid oil} \\ &= \left( \frac{0.046\text{g}}{20\text{ml}} \right) \times 100 \times 25^* = 5.75 \text{ \% w/v} \end{aligned}$$

Density of acid oil = 0.916 g/ml

Mass of acid oil = (0.916 g/ml)(20 ml) = 18.32 g

$$\text{\% } \gamma\text{-oryzanol content (wet basis)} = \left( \frac{0.046\text{g}}{18.32\text{g}} \right) \times 100 \times 25^* = 6.28 \text{ \% wt}$$

\* dilute 25 times

%  $\gamma$ -oryzanol content (dry basis):

Moisture content of acid oil = 1.5 % wt

Convert % moisture content from %w/w to %w/v:

Density of water is 1g/ml and density of acid oil is 0.916 g/ml.

From moisture content of acid oil is 1.5 % wt. It means that there is 1.5 g of water in 100 g of acid oil.

$$\text{Water: 1.5 g of water} \quad = \left( \frac{1.5\text{g}}{1\text{g/ml}} \right) = 1.5 \text{ ml}$$

$$\text{Acid oil: 100 g of acid oil} = \left( \frac{100\text{g}}{0.916\text{g/ml}} \right) = 109.17\text{ ml}$$

$$\text{Moisture content of acid oil (\% w/v)} = \left( \frac{1.5\text{ml}}{109.17\text{ml}} \right) \times 100 = 1.37\% \text{ v/v}$$

Thus, acid oil 1 ml has 0.0137 ml of water. In this experiment, acid oil 20 ml was extracted with ethyl acetate.

Hence, acid oil 20 ml has  $0.0137 \times 20\text{ ml} = 0.274\text{ ml}$

Actual acid oil without moisture:

$$\text{Actual acid oil} = 20\text{ ml} - 0.274\text{ ml} = 19.726\text{ ml}$$

%  $\gamma$ -oryzanol content (dry basis) = Grams of  $\gamma$ -oryzanol / milliliter of acid oil

$$= \left( \frac{0.046\text{g}}{19.726\text{ml}} \right) \times 100 \times 25^* = 5.83\% \text{ w/v}$$

Density of acid oil = 0.916 g/ml

$$\text{Mass of acid oil} = (0.916\text{ g/ml})(19.726\text{ ml}) = 18.07\text{ g}$$

$$\% \gamma\text{-oryzanol content (dry basis)} = \left( \frac{0.046\text{g}}{18.07\text{g}} \right) \times 100 \times 25^* = 6.36\% \text{ wt}$$

\* dilute 25 times

### **C-9 Glycerides content in acid oil extract**

The acid oil extract gave 5.35 mg/ml of glycerides. The total volume of the extract was about 40 ml. Thus, the total amount of glycerides was about 214 mg.

% Glycerides content (wet basis):

$$\% \text{ Glycerides content (wet basis)} = \left( \frac{0.214\text{g}}{20\text{ml}} \right) \times 100 \times 25^* = 26.75\% \text{ w/v}$$

Density of acid oil = 0.916 g/ml

$$\text{Mass of acid oil} = (0.916\text{ g/ml})(20\text{ ml}) = 18.32\text{ g}$$

$$\% \text{ Glycerides content (wet basis)} = \left( \frac{0.214\text{g}}{18.32\text{g}} \right) \times 100 \times 25^* = 29.20\% \text{ wt}$$

\* dilute 25 times

% Glycerides content (dry basis):

$$\% \text{ Glycerides content (dry basis)} = \left( \frac{0.214 \text{ g}}{19.726 \text{ ml}} \right) \times 100 \times 25^* = 27.12 \% \text{ w/v}$$

Density of acid oil = 0.916 g/ml

Mass of acid oil = (0.916 g/ml)(19.726 ml) = 18.07 g

$$\% \text{ Glycerides content (dry basis)} = \left( \frac{0.214 \text{ g}}{18.07 \text{ g}} \right) \times 100 \times 25^* = 29.61 \% \text{ wt}$$

\* dilute 25 times

### **C-10 Fatty acid content in acid oil extract**

The acid oil extract has 1.39 mg/ml of fatty acid. The total volume of the extract was about 40 ml. Thus, the total amount of fatty acid was about 55.6 mg.

% Fatty acid content (wet basis):

$$\% \text{ Fatty acid content (wet basis)} = \left( \frac{0.0556 \text{ g}}{20 \text{ ml}} \right) \times 100 \times 25^* = 6.95 \% \text{ w/v}$$

Density of acid oil = 0.916 g/ml

Mass of acid oil = (0.916 g/ml)(20 ml) = 18.32 g

$$\% \text{ Fatty acid content (wet basis)} = \left( \frac{0.556 \text{ g}}{18.32 \text{ g}} \right) \times 100 \times 25^* = 7.59 \% \text{ wt}$$

\* dilute 25 times

% Fatty acid content (dry basis):

$$\% \text{ Fatty acid content (dry basis)} = \left( \frac{0.556 \text{ g}}{19.726 \text{ ml}} \right) \times 100 \times 25^* = 7.05 \% \text{ w/v}$$

Density of acid oil = 0.916 g/ml

Mass of acid oil = (0.916 g/ml)(19.726 ml) = 18.07 g

$$\% \text{ Fatty acid content (dry basis)} = \left( \frac{0.556 \text{ g}}{18.07 \text{ g}} \right) \times 100 \times 25^* = 29.61 \% \text{ wt}$$

\* dilute 25 times

### C-11 $\gamma$ -oryzanol content in the extract of hydrolyzed acid oil extract

The concentration of the hydrolyzed acid oil extract can be calculated as follow: The extract of hydrolyzed acid oil was analyzed by using RP-HPLC with ELSD detector. The extract of hydrolyzed acid oil was found 0.412 mg/ml of  $\gamma$ -oryzanol and total volume of the extract was found 370 ml. Therefore, the total amount of  $\gamma$ -oryzanol was about 0.152 mg from the solution of acid oil and NaOH 185 ml.

From the experiment, acid oil 1 ml was reacted with 5 ml of NaOH. Thus, the solution of acid oil 6 ml has acid oil only 1 ml.

However in this experiment, the solution of acid oil 185 ml was used for extraction.

Therefore, the solution of acid oil 185 ml has acid oil =  $\left(\frac{185ml \times 1ml}{6ml}\right) = 30.83ml$

%  $\gamma$ -oryzanol content (wet basis):

%  $\gamma$ -oryzanol content (wet basis) = Grams of  $\gamma$ -oryzanol / milliliter of acid oil

$$= \left(\frac{0.15g}{30.83ml}\right) \times 100 \times 10^* = 4.87 \%w/v$$

Density of acid oil = 0.916 g/ml

Mass of acid oil = (0.916 g/ml)(30.83 ml) = 28.24 g

%  $\gamma$ -oryzanol content (wet basis) =  $\left(\frac{0.15g}{28.24g}\right) \times 100 \times 10^* = 5.31 \% wt$

\* dilute 10 times

%  $\gamma$ -oryzanol content (dry basis):

Moisture content of acid oil = 1.5 % wt

Convert % moisture content from %w/w to %w/v:

Density of water is 1g/ml and density of acid oil is 0.916 g/ml.

From moisture content of acid oil is 1.5 %wt. It means that there is 1.5 g of water in 100 g of acid oil.

$$\text{Water: } 1.5 \text{ g of water} = \left(\frac{1.5g}{1g/ml}\right) = 1.5 \text{ ml}$$

$$\text{Acid oil: } 100 \text{ g of acid oil} = \left( \frac{100 \text{ g}}{0.916 \text{ g/ml}} \right) = 109.17 \text{ ml}$$

$$\text{Moisture content of acid oil (\% w/v)} = \left( \frac{1.5 \text{ ml}}{109.17 \text{ ml}} \right) \times 100 = 1.37 \text{ \% v/v}$$

Thus, acid oil 1 ml has 0.0137 ml of water. In this experiment, acid oil 30.83 ml was extracted with ethyl acetate.

Hence, acid oil 30.83 ml has  $0.0137 \times 30.83 \text{ ml} = 0.42 \text{ ml}$

Actual acid oil without moisture:

$$\text{Actual acid oil} = 30.83 \text{ ml} - 0.42 \text{ ml} = 30.41 \text{ ml}$$

%  $\gamma$ -oryzanol content (dry basis) = Grams of  $\gamma$ -oryzanol / milliliter of acid oil

$$= \left( \frac{0.15 \text{ g}}{30.41 \text{ ml}} \right) \times 100 \times 10^* = 4.93 \text{ \% w/v}$$

Density of acid oil = 0.916 g/ml

$$\text{Mass of acid oil} = (0.916 \text{ g/ml})(30.41 \text{ ml}) = 27.86 \text{ g}$$

$$\text{\% } \gamma\text{-oryzanol content (dry basis)} = \left( \frac{0.15 \text{ g}}{27.86 \text{ g}} \right) \times 100 \times 10^* = 5.38 \text{ \% wt}$$

\* dilute 10 times

### **C-12 Glycerides content in the extract of hydrolyzed acid oil extract**

The extract of hydrolyzed acid oil gave 0.065 mg/ml of glycerides. The total volume of the extract was found about 370 ml. Therefore, the total amount of glycerides was about 24.05 mg from the solution of acid oil and NaOH 185 ml.

From the experiment, acid oil 1 ml was reacted with 5 ml of NaOH. Thus, the solution of acid oil 6 ml has acid oil only 1 ml.

However in this experiment, the solution of acid oil 185 ml was used.

$$\text{Therefore, the solution of acid oil 185 ml has acid oil} = \left( \frac{185 \text{ ml} \times 1 \text{ ml}}{6 \text{ ml}} \right) = 30.83 \text{ ml}$$

% glycerides content (wet basis):

$$\text{\% glycerides content (wet basis)} = \left( \frac{0.0241 \text{ g}}{30.83 \text{ ml}} \right) \times 100 \times 10^* = 0.78 \text{ \% w/v}$$

Density of acid oil = 0.916 g/ml

Mass of acid oil = (0.916 g/ml)(30.83 ml) = 28.24 g

$$\% \text{ glycerides content (wet basis)} = \left( \frac{0.0241 \text{ g}}{28.24 \text{ g}} \right) \times 100 \times 10^* = 0.85 \% \text{ wt}$$

\* dilute 10 times

% Glycerides content (dry basis):

Moisture content of acid oil = 1.5 % wt

Convert % moisture content from % w/w to % w/v:

Density of water is 1g/ml and density of acid oil is 0.916 g/ml.

From moisture content of acid oil is 1.5 % wt. It means that there is 1.5 g of water in 100 g of acid oil.

$$\text{Water: 1.5 g of water} = \left( \frac{1.5 \text{ g}}{1 \text{ g/ml}} \right) = 1.5 \text{ ml}$$

$$\text{Acid oil: 100 g of acid oil} = \left( \frac{100 \text{ g}}{0.916 \text{ g/ml}} \right) = 109.17 \text{ ml}$$

$$\text{Moisture content of acid oil (\% w/v)} = \left( \frac{1.5 \text{ ml}}{109.17 \text{ ml}} \right) \times 100 = 1.37 \% \text{ v/v}$$

Thus, acid oil 1 ml has 0.0137 ml of water. In this experiment, acid oil 30.83 ml was extracted with ethyl acetate.

Hence, acid oil 30.83 ml has  $0.0137 \times 30.83 \text{ ml} = 0.42 \text{ ml}$

Actual acid oil without moisture:

$$\text{Actual acid oil} = 30.83 \text{ ml} - 0.42 \text{ ml} = 30.41 \text{ ml}$$

$$\% \text{ Glycerides content (dry basis)} = \left( \frac{0.0241 \text{ g}}{30.41 \text{ ml}} \right) \times 100 \times 10^* = 0.79 \% \text{ w/v}$$

Density of acid oil = 0.916 g/ml

Mass of acid oil = (0.916 g/ml)(30.41 ml) = 27.86 g

$$\% \text{ Glycerides content (dry basis)} = \left( \frac{0.0241 \text{ g}}{27.86 \text{ g}} \right) \times 100 \times 10^* = 0.87 \% \text{ wt}$$

\* dilute 10 times

### C-13 Fatty acid content in the extract of hydrolyzed acid oil extract

The extract of hydrolyzed acid oil gave 1.01 mg/ml of fatty acid. The total volume of the extract was found about 370 ml. Therefore, the total amount of fatty acid was about 375.55 mg from the solution of acid oil and NaOH 185 ml.

From the experiment, acid oil 1 ml was reacted with 5 ml of NaOH. Thus, the solution of acid oil 6 ml has acid oil only 1 ml.

However in this experiment, the solution of acid oil 185 ml was used.

Therefore, the solution of acid oil 185 ml has acid oil =  $\left(\frac{185ml \times 1ml}{6ml}\right) = 30.83ml$

% Fatty acid content (wet basis):

$$\% \text{ Fatty acid content (wet basis)} = \left(\frac{0.376g}{30.83ml}\right) \times 100 \times 10^* = 12.20 \%w/v$$

Density of acid oil = 0.916 g/ml

Mass of acid oil = (0.916 g/ml)(30.83 ml) = 28.24 g

$$\% \text{ Fatty acid content (wet basis)} = \left(\frac{0.376g}{28.24g}\right) \times 100 \times 10^* = 13.31 \% \text{ wt}$$

\* dilute 10 times

% Fatty acid content (dry basis):

Moisture content of acid oil = 1.5 %wt

Convert % moisture content from %w/w to %w/v:

Density of water is 1g/ml and density of acid oil is 0.916 g/ml.

From moisture content of acid oil is 1.5 %wt. It means that there is 1.5 g of water in 100 g of acid oil.

$$\text{Water: 1.5 g of water} = \left(\frac{1.5g}{1g/ml}\right) = 1.5 \text{ ml}$$

$$\text{Acid oil: 100 g of acid oil} = \left(\frac{100g}{0.916g/ml}\right) = 109.17 \text{ ml}$$

$$\text{Moisture content of acid oil (\% w/v)} = \left(\frac{1.5ml}{109.17ml}\right) \times 100 = 1.37 \%v/v$$

Thus, acid oil 1 ml has 0.0137 ml of water. In this experiment, acid oil 30.83 ml was extracted with ethyl acetate.

Hence, acid oil 30.83 ml has  $0.0137 \times 30.83 \text{ ml} = 0.42 \text{ ml}$

Actual acid oil without moisture:

$$\text{Actual acid oil} = 30.83 \text{ ml} - 0.42 \text{ ml} = 30.41 \text{ ml}$$

$$\% \text{ Fatty acid content (dry basis)} = \left( \frac{0.376 \text{ g}}{30.41 \text{ ml}} \right) \times 100 \times 10^* = 12.36 \% \text{ w/v}$$

Density of acid oil = 0.916 g/ml

$$\text{Mass of acid oil} = (0.916 \text{ g/ml})(30.41 \text{ ml}) = 27.86 \text{ g}$$

$$\% \text{ Fatty acid content (dry basis)} = \left( \frac{0.376 \text{ g}}{27.86 \text{ g}} \right) \times 100 \times 10^* = 13.50 \% \text{ wt}$$

\* dilute 10 times

#### C-14 $\gamma$ -oryzanol loss in hydrolysis step\*

Original acid oil sample	20	ml
or original acid oil sample	18.52	g
$\gamma$ -oryzanol in original acid oil sample	1.15	g
Therefore, $\gamma$ -oryzanol in 1 g of original acid oil sample	0.062	g

After hydrolysis step;

Hydrolyzed acid oil	185	ml
or hydrolyzed acid oil	28.24	g
$\gamma$ -oryzanol in hydrolyzed acid oil	1.52	g
Therefore, $\gamma$ -oryzanol in 1 g of hydrolyzed acid oil	0.0054	g

$$\gamma\text{-oryzanol loss in hydrolysis step} = \left( \frac{0.062 - 0.054}{0.062} \right) \times 100 = 12.90 \%$$

\*The calculation was based on dry basis



## APPENDIX D

### EXPERIMENTAL DATA FOR CHROMATOGRAPHY COLUMN

#### D-1 Calculation of %yield, %recovery and %purity of $\gamma$ -oryzanol

%Recovery of  $\gamma$ -oryzanol:

% Recovery of  $\gamma$ -oryzanol =

$$\left( \frac{\text{Total weight of gamma oryzanol in all fractions}}{\text{Weight of gamma oryzanol in the extract loaded on the column}} \right) \times 100 \quad (\text{D-1.1})$$

%Yield of  $\gamma$ -oryzanol:

% Yield of  $\gamma$ -oryzanol =

$$\left( \frac{\text{Total weight of gamma oryzanol in the fractions (more than 95\% of purity)}}{\text{Weight of gamma oryzanol in the extract loaded on the column}} \right) \times 100 \quad (\text{D-1.2})$$

% Purity of  $\gamma$ -oryzanol:

The purity of each component found in this study was determined by the % peak area from the RP-HPLC chromatogram. The % peak area was compared with the calibration curve of standard  $\gamma$ -oryzanol which was shown in Appendix A-1.

#### D-2 Example calculation of %recovery and %yield of $\gamma$ -oryzanol

An example calculation for %recovery and % yield of  $\gamma$ -oryzanol was determined in this section. Hydrolyzed acid oil sample stock solution 1 ml was loaded into the semi-preparative glass column chromatography. The column was packed with 10 g of silica gel (25-40  $\mu\text{m}$ ) eluting with hexane-to-ethyl acetate ratio of 75:25 v/v. Each fraction was collected every 5 minutes and was then analyzed by RP-HPLC equipped with ELSD detector. The data experiment of  $\gamma$ -oryzanol from chromatography experiment was shown in Table D-2.1. The %recovery and %yield calculation of  $\gamma$ -oryzanol were shown as follow:

**Table D-2.1** Experimental data of  $\gamma$ -oryzanol from chromatography experiment

Time (minute)	Area of $\gamma$ -oryzanol (injection 5 $\mu$ l)	%Area	Concentration of $\gamma$ -oryzanol (mg/ml)	$\gamma$ -oryzanol (mg)
95	462.93	7.90	0.04	0.08
100	1634.93	42.89	0.15	0.29
105	2495.09	79.59	0.22	0.45
110	4056.82	99.01	0.37	0.73
115	5378.83	100.00	0.48	0.97
120	7134.96	100.00	0.64	1.28
125	7886.43	99.93	0.71	1.42
130	9273.28	100.00	0.83	1.67
135	8461.26	99.69	0.76	1.52
140	6964.53	100.00	0.63	1.25
145	5882.24	99.62	0.53	1.06
150	4365.82	99.90	0.39	0.79
155	3133.07	99.77	0.28	0.56
160	2000.25	99.77	0.18	0.36
165	1225.30	99.46	0.11	0.22
170	580.15	100.00	0.05	0.10
175	323.69	98.09	0.03	0.06
180	191.01	97.40	0.02	0.03
185	22.27	87.38	0.002	0.004
Total amount of $\gamma$ -oryzanol (mg)				12.87
Total amount of $\gamma$ -oryzanol for fraction which has more than 95% of purity (mg)				12.04
% Recovery of $\gamma$ -oryzanol				89.42
%Yield of $\gamma$ -oryzanol (Purity95% up)				83.64

% Recovery of  $\gamma$ -oryzanol =

$$\left( \frac{\text{Total weight of gamma oryzanol in all fractions}}{\text{Weight of gamma oryzanol in the extract loaded on the column}} \right) \times 100$$

$$\% \text{ Recovery of } \gamma\text{-oryzanol} = \left( \frac{12.87 \text{ mg}}{14.39 \text{ mg}} \right) \times 100 = 89.42\%$$

% Yield of  $\gamma$ -oryzanol =

$$\left( \frac{\text{Total weight of gamma oryzanol in the fractions (more than 95\% of purity)}}{\text{Weight of gamma oryzanol in the extract loaded on the column}} \right) \times 100$$

$$\% \text{ Yield of } \gamma\text{-oryzanol} = \left( \frac{12.04\text{mg}}{14.39 \text{ mg}} \right) \times 100 = 83.64\%$$

### D-3 Experimental data for column chromatography

**Table D-3.1** Percent recovery and yield of  $\gamma$ -oryzanol from column chromatography at various the amount of silica gel packed

Amount of silica gel packed (25-40 $\mu$ m)	%Recovery	% Yield
5 g	72.41	69.25
10 g	89.42	83.64
15 g	63.25	28.39

**Table D-3.2** Percent recovery and yield of  $\gamma$ -oryzanol from column chromatography at various the size of silica gel packed

Size of silica gel packed (10 g)	%Recovery	% Yield
15-25 $\mu$ m	50.36	49.77
25-40 $\mu$ m	89.42	83.64
40-63 $\mu$ m	63.67	60.37

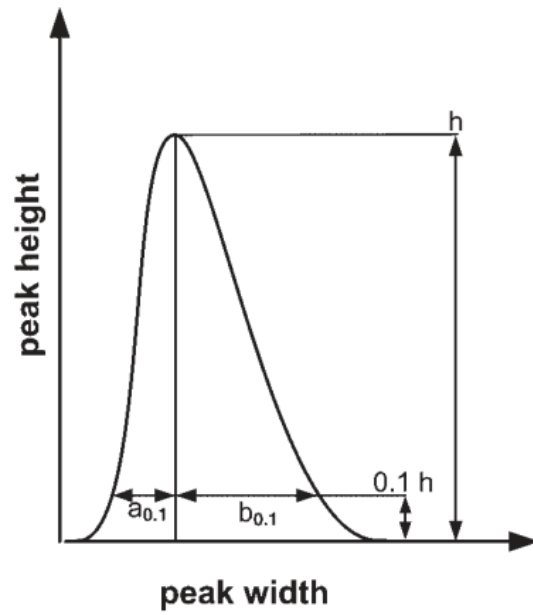
**Table D-3.3** Percent recovery and yield of  $\gamma$ -oryzanol from column chromatography two elution modes

Elution mode	% Recovery	% Yield
Isocratic mode	89.42	83.64
Gradient mode	90.49	90.15

#### **D-4 Example calculation of retention time in a semi-preparative column chromatography**

A calculation for retention time of  $\gamma$ -oryzanol, glycerides and fatty acid was calculated. Hydrolyzed acid oil sample stock solution 1 ml was loaded into the semi-preparative glass column chromatography. The column was packed with 10 g of silica gel (25-40  $\mu\text{m}$ ) eluting with hexane-to-ethyl acetate ratio of 75:25 v/v. Each fraction was collected every 5 minutes and was then analyzed by RP-HPLC equipped with ELSD detector. An example of retention time calculation of  $\gamma$ -oryzanol was shown below.

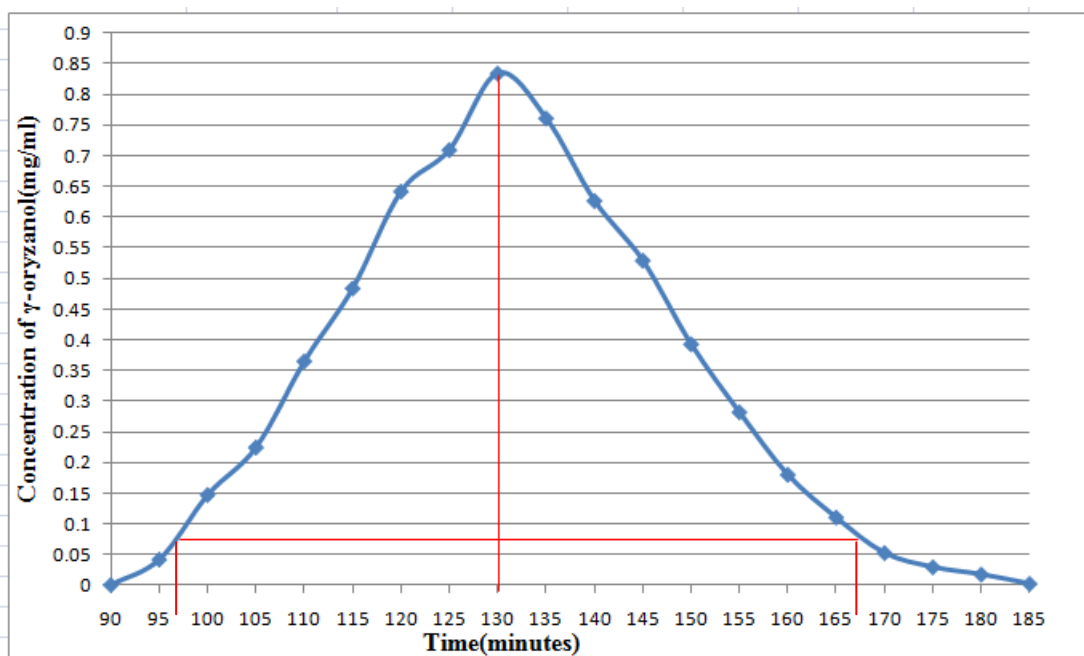
Before calculation of retention time, the type of peak was identified. There are two types of peak which can be found in chromatogram that are symmetric and asymmetric peak. Types of peak were determined by using Figure D-4.1 and equation D-4.1. The peak of  $\gamma$ -oryzanol that got from the experiment was shown in Figure D-4.2.



**Figure D-4.1** asymmetric peak

$$T = \frac{b_{0.1}}{a_{0.1}} \quad (\text{D-4.1})$$

; T is the degree of peak asymmetric



**Figure D-4.2** The peak chromatogram of  $\gamma$ -oryzanol

From FigureD-4.2,

$$\begin{aligned}
 h &= 0.84 \text{ mg/ml} \\
 0.1h &= (0.1)(0.84 \text{ mg/ml}) \\
 &= 0.084 \text{ mg/ml} \\
 b_{0.1} &= 167 \text{ min} - 130 \text{ min} \\
 &= 37 \text{ min} \\
 a_{0.1} &= 130 \text{ min} - 97 \text{ min} \\
 &= 33 \text{ min}
 \end{aligned}$$

$$T = \frac{b_{0.1}}{a_{0.1}} = \frac{37 \text{ min}}{33 \text{ min}} = 1.12$$

Thus, this peak was asymmetric peak.

For asymmetric peaks, the mean retention time of chromatogram is calculated by the first absolute moment which shows in equation D-4.2.

$$\mu_t = \frac{\int_0^{\infty} tc(t)dt}{\int_0^{\infty} c(t)dt} \approx \frac{\sum_{j=1}^{n_p} t_j C_j \Delta t}{\sum_{j=1}^{n_p} C_j \Delta t} \quad (\text{D-4.2})$$

The variance  $\sigma_t^2$  is calculated from the second central moment which was shown in equation D-4.3.

$$\sigma_t^2 = \frac{\int_0^{\infty} (t - \mu)^2 c(t)dt}{\int_0^{\infty} c(t)dt} \approx \frac{\sum_{j=1}^{n_p} (t_j - \mu_t)^2 C_j \Delta t}{\sum_{j=1}^{n_p} C_j \Delta t} \quad (\text{D-4.3})$$

Since difference time ( $\Delta t$ ) is the same for every increment, equation D-4.2 and D-4.3 can be reduced as expressed in equation D-4.4 and D-4.5, respectively.

$$\mu_t = \frac{\sum_{j=1}^{n_p} t_j C_j}{\sum_{j=1}^{n_p} C_j} \quad (\text{D-4.4})$$

$$\sigma_t^2 = \frac{\sum_{j=1}^{n_p} (t_j - \mu_t)^2 C_j}{\sum_{j=1}^{n_p} C_j} \quad (\text{D-4.5})$$

According to experimental results, retention time and variance of  $\gamma$ -oryzanol and glycerides were determined and shown in Table D-4.1 – D-4.12, respectively.

**Table D-4.1** Experiment results of column with silica gel 5 g and 25-40  $\mu\text{m}$  ( $\gamma$ -oryzanol)

j	Time ( $t_j$ , min)	Concentration of $\gamma$ -oryzanol ( $C_j$ , mg/l)	$t_j * C_j$	$(t_j - \mu_t)^2 * C_j$
1	30	0.000	0.00	0.00
2	35	0.011	0.38	26.83
3	40	0.080	3.19	158.78
4	45	0.101	4.52	158.06
5	50	0.079	3.93	94.27
6	55	0.159	8.75	139.81
7	60	0.232	13.94	141.12
8	65	0.284	18.44	109.48
9	70	0.440	30.79	94.35
10	75	0.552	41.38	51.34
11	80	0.548	43.83	11.83
12	85	0.465	39.51	0.06
13	90	0.370	33.33	10.61
14	95	0.256	24.28	27.40
15	100	0.182	18.20	42.89
16	105	0.145	15.24	60.11
17	110	0.116	12.79	74.73
18	115	0.150	17.28	138.45

19	120	0.145	17.36	180.79
20	125	0.201	25.08	326.73
21	130	0.135	17.61	278.58
22	135	0.057	7.76	145.67
23	140	0.011	1.48	32.46
24	145	0.003	0.47	11.69
25	150	0.001	0.12	3.41
<hr/>				
$\sum_{j=1}^{25} C_j = 4.721$ $\sum_{j=1}^{25} t_j C_j = 399.64$ $\sum_{j=1}^{25} (t_j - \mu_t)^2 C_j = 2319.13$				
<hr/>				
$\mu_t = 399.64/4.721$ $\sigma^2 = 2319.13/4.721$				
$= 84.65 \text{ min}$ $= 22.16 \text{ min}^2$				
<hr/>				

**Table D-4.2** Experiment results of column with silica gel 10 g and 25-40  $\mu\text{m}$  ( $\gamma$ -oryzanol)

j	Time ( $t_j$ , min)	Concentration of $\gamma$ -oryzanol ( $C_j$ , mg/l)	$t_j * C_j$	$(t_j - \mu_t)^2 * C_j$
1	90	0.000	3.96	0.00
2	95	0.042	14.71	55.93
3	100	0.147	23.58	147.28
4	105	0.225	40.16	159.34
5	110	0.365	55.67	170.94
6	115	0.484	77.06	134.00
7	120	0.642	88.72	86.97
8	125	0.710	108.50	31.27
9	130	0.835	102.80	2.24
10	135	0.762	87.75	8.61
11	140	0.627	76.76	43.83
12	145	0.529	58.94	94.53
13	150	0.393	43.71	132.49
14	155	0.282	28.80	153.90
15	160	0.180	18.20	144.82
16	165	0.110	8.88	122.74
17	170	0.052	5.10	76.84
18	175	0.029	3.09	54.78
19	180	0.017	0.37	40.21
20	185	0.002	3.96	5.71



$$\sum_{j=1}^{20} C_j = 6.433 \quad \sum_{j=1}^{20} t_j C_j = 846.77 \quad \sum_{j=1}^{20} (t_j - \mu_t)^2 C_j = 1666.41$$

$$\begin{aligned} \mu_t &= 846.77/6.433 & \sigma^2 &= 1666.41/46.433 \\ &= 131.64 \text{ min} & &= 259.06 \text{ min}^2 \end{aligned}$$

**Table D-4.3** Experiment results of column with silica gel 15 g and 25-40  $\mu\text{m}$  ( $\gamma$ -oryzanol)

j	Time ( $t_j$ , min)	Concentration of $\gamma$ -oryzanol ( $C_j$ , mg/l)	$t_j * C_j$	$(t_j - \mu_t)^2 * C_j$
1	290	0.000	0.00	0.00
2	295	0.047	13.94	317.55
3	300	0.069	20.61	407.07
4	305	0.073	22.16	376.28
5	310	0.093	28.97	419.18
6	315	0.369	116.15	1416.06
7	320	0.151	48.23	489.17
8	325	0.160	51.92	431.51
9	330	0.099	32.82	219.41
10	335	0.091	30.41	159.89
11	340	0.087	29.49	118.57
12	345	0.084	28.95	85.77
13	350	0.140	49.14	102.15
14	355	0.132	46.72	63.54
15	360	0.126	45.24	36.20
16	365	0.098	35.60	13.98
17	370	0.160	59.34	7.80
18	375	0.157	58.89	0.61
19	380	0.145	55.16	1.33
20	385	0.119	45.80	7.67
21	390	0.116	45.39	19.75
22	395	0.093	36.70	30.20
23	400	0.085	33.92	44.97
24	405	0.074	29.82	57.85
25	410	0.051	21.07	56.07
26	415	0.115	47.80	166.58
27	420	0.109	45.75	201.66
28	425	0.096	40.71	220.94
29	430	0.156	66.93	437.66

30	435	0.235	102.33	792.09
31	440	0.235	103.27	932.37
32	445	0.168	74.71	776.91
33	450	0.099	44.45	526.79
34	455	0.082	37.32	499.37
35	460	0.006	2.59	38.88
		$\sum_{j=1}^{35} C_j = 4.118$	$\sum_{j=1}^{35} t_j C_j = 1552.28$	$\sum_{j=1}^{35} (t_j - \mu_t)^2 C_j = 9475.80$
			$\mu_t = 1552.28/4.118 = 376.97 \text{ min}$	$\sigma^2 = 9475.80/4.118 = 2301.20 \text{ min}^2$

**Table D-4.4** Experiment results of column with silica gel 15-25  $\mu\text{m}$  and 10 g ( $\gamma$ -oryzanol)

j	Time ( $t_j$ , min)	Concentration of $\gamma$ -oryzanol ( $C_j$ , mg/l)	$t_j * C_j$	$(t_j - \mu_t)^2 * C_j$
1	165	0.000	0.00	0.00
2	170	0.019	3.21	469.17
3	175	0.005	0.85	112.43
4	180	0.003	0.53	63.73
5	185	0.003	0.55	60.70
6	190	0.004	0.67	67.23
7	195	0.005	0.96	86.19
8	200	0.004	0.85	69.01
9	205	0.005	1.05	77.03
10	210	0.007	1.40	92.21
11	215	0.009	1.98	116.59
12	220	0.010	2.26	118.88
13	225	0.013	2.83	132.39
14	230	0.012	2.84	117.52
15	235	0.019	4.40	160.33
16	240	0.024	5.87	187.55
17	245	0.019	4.69	130.52
18	250	0.027	6.78	163.23
19	255	0.074	18.90	390.29
20	260	0.029	7.54	132.37

21	265	0.023	5.98	88.34
22	270	0.017	4.53	55.57
23	275	0.024	6.64	66.77
24	280	0.025	7.11	57.42
25	285	0.045	12.88	81.86
26	290	0.039	11.24	54.72
27	295	0.065	19.13	68.77
28	300	0.060	18.09	45.83
29	305	0.102	31.26	52.20
30	310	0.140	43.30	43.12
31	315	0.132	41.52	20.82
32	320	0.151	48.39	8.66
33	325	0.196	63.73	1.29
34	330	0.163	53.73	0.96
35	335	0.205	68.53	11.30
36	340	0.232	78.73	35.78
37	345	0.211	72.82	64.14
38	350	0.247	86.57	124.45
39	355	0.210	74.53	157.97
40	360	0.217	78.06	228.06
41	365	0.178	64.99	249.46
42	370	0.190	70.29	342.04
43	375	0.121	45.37	272.18
44	380	0.000	0.00	0.00

---


$$\sum_{j=1}^{44} C_j = 3.283$$

$$\sum_{j=1}^{44} t_j C_j = 1075.56$$

$$\sum_{j=1}^{44} (t_j - \mu_t)^2 C_j = 4879.11$$


---


$$\mu_t = 1075.56/3.283 = 327.57 \text{ min}$$

$$\sigma^2 = 4879.11/3.283 = 1485.96 \text{ min}^2$$


---

**Table D-4.5** Experiment results of column with silica gel 40-63 $\mu$ m and 10 g ( $\gamma$ -oryzanol)

j	Time ( $t_j$ , min)	Concentration of $\gamma$ -oryzanol ( $C_j$ , mg/l)	$t_j * C_j$	$(t_j - \mu_t)^2 * C_j$
1	25	0.000	0.00	0.00
2	30	0.215	6.46	42.93

3	35	0.282	9.87	23.43
4	40	1.164	46.57	19.73
5	45	1.586	71.35	1.24
6	50	0.480	24.01	16.62
7	55	0.269	14.82	31.92
8	60	0.071	4.28	17.98
9	65	0.036	2.36	15.82
10	70	0.026	1.84	17.57
11	75	0.016	1.20	15.28
12	80	0.005	0.41	6.56
<hr/>				
		$\sum_{j=1}^{12} C_j$	$= \sum_{j=1}^{12} t_j C_j = 183.16$	$\sum_{j=1}^{12} (t_j - \mu_t)^2 C_j =$
		4.152		209.08
<hr/>				
			$\mu_t = 1075.56/3.283$	$\sigma^2 = 4879.11/3.283$
			$= 44.12 \text{ min}$	$= 50.36 \text{ min}^2$

**Table D-4.6** Experiment results of column with silica gel 10 g and 25-40  $\mu\text{m}$  eluting with gradient elution ( $\gamma$ -oryzanol)

j	Time ( $t_j$ , min)	Concentration of $\gamma$ -oryzanol ( $C_j$ , mg/l)	$t_j * C_j$	$(t_j - \mu_t)^2 * C_j$
1	100	0.000	0.00	0.00
2	105	0.001	0.10	7.01
3	110	0.006	0.63	37.93
4	115	0.006	0.69	34.83
5	120	0.004	0.49	20.95
6	125	0.004	0.56	19.57
7	130	0.006	0.74	21.33
8	135	0.007	0.94	22.14
9	140	0.008	1.17	21.93
10	145	0.029	4.18	61.70
11	150	0.074	11.11	126.18
12	155	0.134	20.74	175.98
13	160	0.155	24.77	151.38
14	165	0.174	28.73	120.18
15	170	0.224	38.14	101.50
16	175	0.316	55.37	83.75
17	180	0.400	71.92	50.75
18	185	0.477	88.23	18.74

19	190	0.596	113.20	0.96
20	195	0.675	131.59	9.39
21	200	0.705	140.96	53.72
22	205	0.608	124.62	114.61
23	210	0.444	93.20	155.70
24	215	0.242	52.13	136.54
25	220	0.139	30.60	114.80
26	225	0.074	16.57	83.78
27	230	0.039	8.95	58.36
28	235	0.010	2.24	18.23
29	240	0.002	0.51	5.08

---


$$\sum_{j=1}^{29} C_j = 5.558 \quad \sum_{j=1}^{29} t_j C_j = 1063.08 \quad \sum_{j=1}^{29} (t_j - \mu_t)^2 C_j = 1827.02$$


---


$$\mu_t = 1063.08/5.558 \quad \sigma^2 = 1827.02/5.558$$

$$= 191.27 \text{ min} \quad = 328.72 \text{ min}^2$$


---

**Table D-4.7** Experiment results of column with silica gel 5 g and 25-40  $\mu\text{m}$   
(Glycerides)

j	Time ( $t_j$ , min)	Concentration of glycerides ( $C_j$ , mg/l)	$t_j * C_j$	$(t_j - \mu_t)^2 * C_j$
1	30	0.000	0.00	0.00
2	35	1.075	37.63	19.22
3	40	2.574	102.98	1.53
4	45	0.407	18.32	13.56
5	50	0.020	0.98	2.27
6	55	0.000	0.00	0.00

---


$$\sum_{j=1}^6 C_j = 4.076 \quad \sum_{j=1}^6 t_j C_j = 159.90 \quad \sum_{j=1}^6 (t_j - \mu_t)^2 C_j = 36.58$$


---


$$\mu_t = 159.90/4.076 \quad \sigma^2 = 36.58/4.076$$

$$= 39.23 \text{ min} \quad = 8.97 \text{ min}^2$$


---

**Table D-4.8** Experiment results of column with silica gel 10 g and 25-40  $\mu\text{m}$   
(Glycerides)

j	Time ( $t_j$ , min)	Concentration of glycerides ( $C_j$ , mg/l)	$t_j * C_j$	$(t_j - \mu_t)^2 * C_j$
1	90	0.000	0.00	0.00
2	95	1.141	108.36	15.62
3	100	0.901	90.12	1.52
4	105	0.444	46.58	17.61
5	110	0.022	2.47	2.87
6	115	0.000	0.00	0.00
		$\sum_{j=1}^6 C_j = 2.508$	$\sum_{j=1}^6 t_j C_j = 247.53$	$\sum_{j=1}^6 (t_j - \mu_t)^2 C_j = 37.62$
			$\mu_t = 247.53/2.508$ $= 98.70 \text{ min}$	$\sigma^2 = 37.62/2.508$ $= 15.00 \text{ min}^2$

**Table D-4.9** Experiment results of column with silica gel 15 g and 25-40  $\mu\text{m}$   
(Glycerides)

j	Time ( $t_j$ , min)	Concentration of glycerides ( $C_j$ , mg/l)	$t_j * C_j$	$(t_j - \mu_t)^2 * C_j$
1	290	0.000	0.00	0.00
2	295	0.695	205.05	19.68
3	300	0.586	175.70	0.06
4	305	0.189	57.59	4.13
5	310	0.066	20.55	6.21
6	315	0.071	22.44	15.35
7	320	0.026	8.34	10.09
8	325	0.008	2.50	4.68
9	330	0.010	3.28	8.76
10	335	0.009	3.07	11.02
11	340	0.000	0.00	0.00
		$\sum_{j=1}^{11} C_j = 1.660$	$\sum_{j=1}^{11} t_j C_j = 498.52$	$\sum_{j=1}^{11} (t_j - \mu_t)^2 C_j = 79.99$
			$\mu_t = 498.52/1.660$ $= 300.32 \text{ min}$	$\sigma^2 = 79.99/1.660$ $= 48.19 \text{ min}^2$

**Table D-4.10** Experiment results of column with silica gel 15-25  $\mu\text{m}$  and 10 g (Glycerides)

j	Time ( $t_j$ , min)	Concentration of glycerides ( $C_j$ , mg/l)	$t_j * C_j$	$(t_j - \mu_t)^2 * C_j$
1	165	0.054	8.89	3.44
2	170	2.314	393.46	20.73
3	175	1.089	190.52	4.39
4	180	0.498	89.64	24.45
5	185	0.063	11.74	9.15
6	190	0.044	8.45	12.86
7	195	0.007	1.46	3.63
8	200	0.054	0.00	0.00
		$\sum_{j=1}^{25} C_j = 4.070$	$\sum_{j=1}^{25} t_j C_j = 704.15$	$\sum_{j=1}^{25} (t_j - \mu_t)^2 C_j = 78.65$
			$\mu_t = 704.15/4.070$ $= 172.99 \text{ min}$	$\sigma^2 = 78.65/4.070$ $= 19.32 \text{ min}^2$

**Table D-4.11** Experiment results of column with silica gel 40-63  $\mu\text{m}$  and 10 g (Glycerides)

j	Time ( $t_j$ , min)	Concentration of glycerides ( $C_j$ , mg/l)	$t_j * C_j$	$(t_j - \mu_t)^2 * C_j$
1	25	0.000	0.00	0.00
2	30	3.914	117.43	0.00
3	35	0.000	0.00	0.00
		$\sum_{j=1}^{25} C_j = 3.914$	$\sum_{j=1}^{25} t_j C_j = 117.43$	$\sum_{j=1}^{25} (t_j - \mu_t)^2 C_j = 0.00$
			$\mu_t = 117.43/3.914$ $= 30 \text{ min}$	$\sigma^2 = 0.00/4.070$ $= 0.00 \text{ min}^2$

**Table D-4.12** Experiment results of column with silica gel 10 g and 25-40  $\mu\text{m}$  eluting with gradient elution (Glycerides)

j	Time ( $t_j$ , min)	Concentration of $\gamma$ -oryzanol ( $C_j$ , mg/l)	$t_j \cdot C_j$	$(t_j - \mu_t)^2 \cdot C_j$
1	100	0.000	0.00	0.00
2	105	0.270	28.32	12.49
3	110	1.183	130.08	3.85
4	115	0.510	58.64	5.21
5	120	0.261	31.31	17.53
6	125	0.015	1.89	2.64

---


$$\sum_{j=1}^6 C_j = 2.238 \quad \sum_{j=1}^6 t_j C_j = 250.25 \quad \sum_{j=1}^6 (t_j - \mu_t)^2 C_j = 41.71$$


---


$$\mu_t = 250.25/2.238 \quad \sigma^2 = 41.71/2.238$$

$$= 111.80 \text{ min} \quad = 18.63 \text{ min}^2$$


---

### D-5 Example calculation of plate number and column efficiency in preparative column chromatography

Both retention time and variance  $\sigma_t^2$  were known from the previous part. This part is aim to show calculation of plate number and column efficiency of the column. In order to find column efficiency plate number was be calculated first. The plate number was found from equation D-5.1 for asymmetric peak.

$$N_i = 41.7 \left[ \frac{\left(\frac{t_{R,i}}{W_{t0.1}}\right)^2}{1.25 + \frac{b_{0.1i}}{a_{0.1i}}} \right] \quad (\text{D-5.1})$$

;  $t_{R,i}$  is retention time of component i (min)

$W_{t0.1}$  is peak width which its value is approximately equal to 4 times of standard deviation ( $W_{t0.1} = 4\sigma$ , min)

$a_{0.1i}$  and  $b_{0.1i}$  is determined as explained in Appendix D-4 (min)



According to the chromatogram shown in Figure D-4.2 which relates to experimental data in Table D-4.2, all parameters can be substituted and the plate number was found as shown below.

$$N_i = 41.7 \left[ \frac{\left(\frac{134.64}{64.38}\right)^2}{1.25 + \frac{37}{33}} \right] = 73.52$$

The plate number that found in this experiment was about 73.52 plates. Therefore, height of an equivalent theoretical plate (HETP) can be calculated in equation D-5.2.

$$HETP = \frac{L_c}{N} \quad (D-5.2)$$

; HETP is height of an equivalent theoretical plate (cm/plate)

$L_c$  is height of silica gel packed in column(cm)

N is plate number (plate)

The experiment has 23 cm of silica gel height and the plate number was about 73.52 plates. Therefore, height of an equivalent theoretical plate can determine as followed:

$$HETP = \frac{23cm}{73.25 plates} = 0.31 \frac{cm}{plate}$$

Plate number and HETP for each experiment are determined based on  $\gamma$ -oryzanol and shown in Table D-5.1.

**Table D-5.1** Plate number and HETP

Amount of silica gel (g)	Particle size ( $\mu\text{m}$ )	Retention time ( $t_{R,\text{min}}$ )	$\sigma$ (min)	Peak		Plate number (N)	$L_c$ (cm)	HETP *
				width ( $W_{10.1}$ , min)	$a_{0.1}$ $b_{0.1}$			
5	25-40	84.65	22.2	88.7	38 58	13.7	10.0	0.73
10	25-40	131.64	16.1	67.4	33 37	73.5	23.0	0.31
15	25-40	376.97	48.0	191.9	21 $\frac{14}{3}$	20.0	33.0	1.65
10	15-25	327.57	38.5	154.2	77 30	114.8	23.0	0.34
10	40-63	44.12	7.1	28.4	16 13	48.8	23.0	0.67
10 (Gradient)	25-40	191.27	18.1	72.5	49 27	161.0	23.0	0.14

\*HETP value was calculated in order to find the efficiency of the column chromatography. However, in this study the recovery of  $\gamma$ -oryzanol was not the same at each condition. Therefore, HETP value could not use as quantitative value for this study.

#### D-6 Calculation of resolution

The chromatographic resolution,  $R_s$ , is the parameter which can measure how well two adjacent peak profiles of similar area are separated.  $R_s$  can be defined as equation D-6.1.

$$R_s = \frac{2(t_{R,j} - t_{R,i})}{w_j + w_i} \quad (\text{D-6.1})$$

;  $t_{R,i}$  and  $t_{R,j}$  are the retention time of component i and j, of which component i eluted first ( $t_{R,j} > t_{R,i}$ )

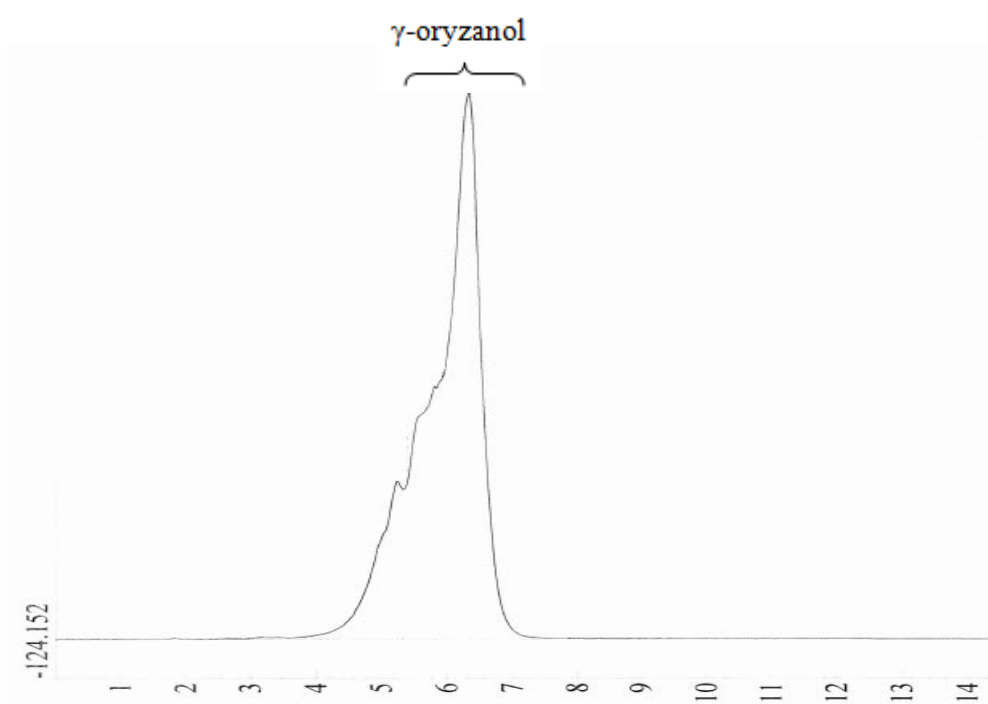
$w_i$  and  $w_j$  are the peak width of component i and j

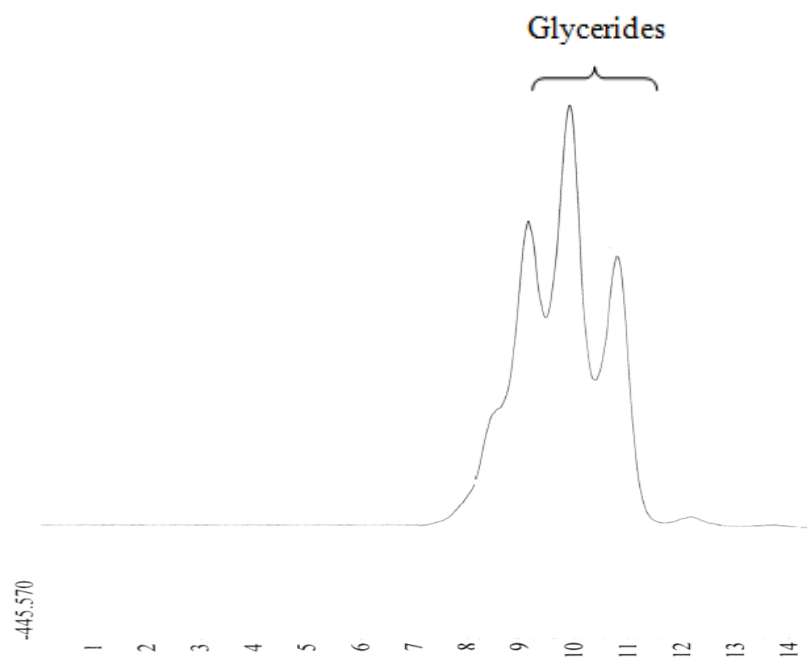
Component i and j are  $\gamma$ -oryzanol and glycerides, respectively.

For instance referred to experimental data in Table D-4.2 and Table D-4.7, all parameters can be substituted in equation D-6.1 and the chromatographic resolution was found as shown in Table D-6.1.

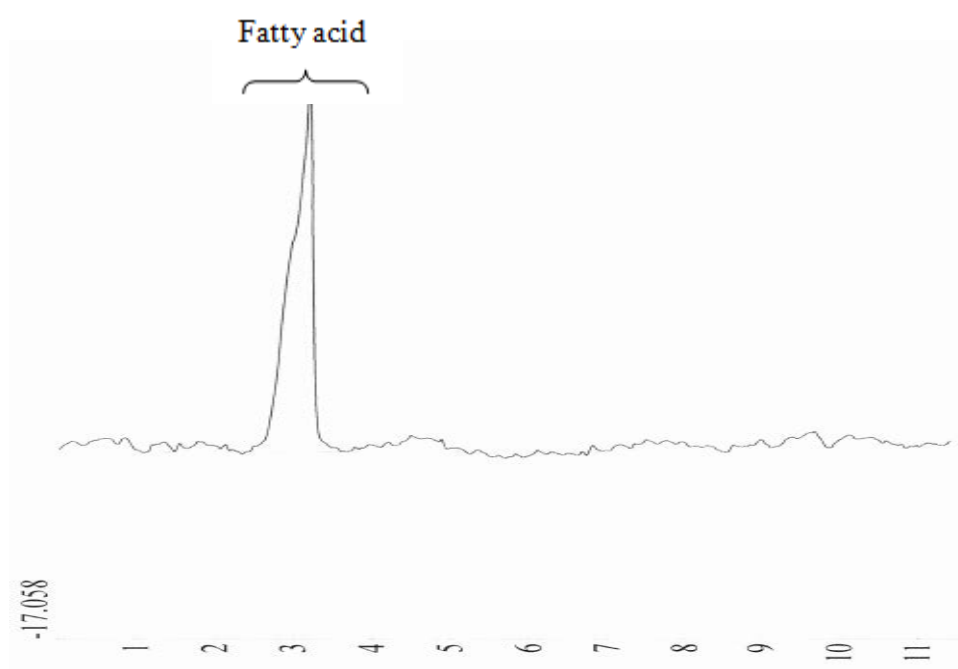
**Table D-6.1** The chromatographic resolution

Amount of silica gel (g)	Particle size ( $\mu\text{m}$ )	Retention time of $\gamma$ -oryzanol ( $t_{R,i}$ ,min)	Retention time of glycerides ( $t_{R,j}$ ,min)	Peak width of $\gamma$ -oryzanol ( $W_{t0.1}$ , min)	Peak width of glycerides ( $W_{t0.1}$ , min)	$R_s$
5	25-40	84.65	39.23	88.7	11.98	0.90
10	25-40	131.64	165.24	67.4	15.49	0.82
15	25-40	376.97	300.32	191.9	27.77	0.70
10	15-25	327.57	173.00	154.2	17.58	1.80
10	40-63	44.12	77.67	28.4	6.00	0.82
10 (Gradient)	25-40	191.27	111.80	72.5	17.27	1.77

**D-7 Chromatogram of the fractions from column chromatography****Figure D-7.1** Chromatogram of the fraction (pure  $\gamma$ -oryzanol) analyzed by RP-HPLC detect with ELSD detector



**Figure D-7.2** Chromatogram of the fraction (pure glycerides) analyzed by RP-HPLC detect with ELSD detector.



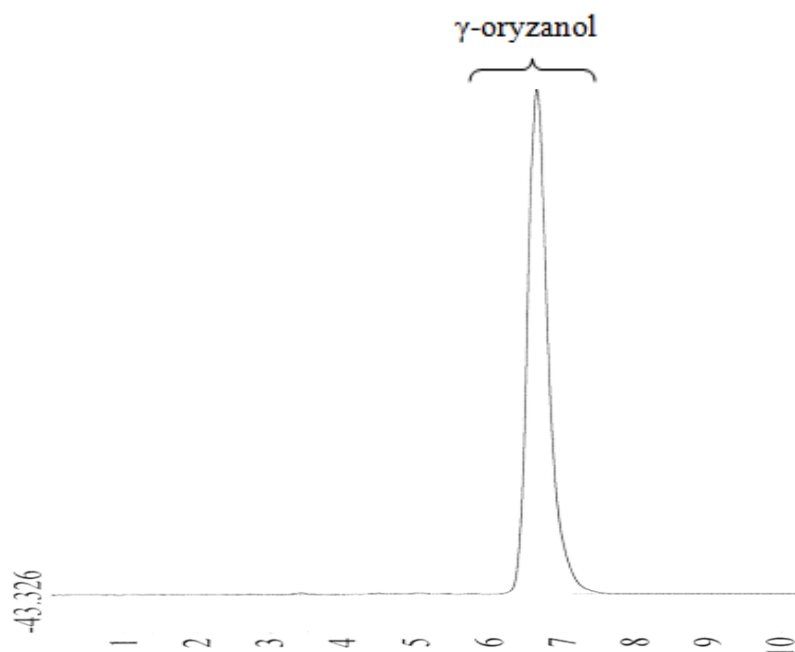
**Figure D-7.3** Chromatogram of the fraction (pure fatty acid) analyzed by RP-HPLC detect with ELSD detector

## APPENDIX E

### THE ANALYSIS OF $\gamma$ -ORYZANOL BY USING LIQUID CHROMATOGRAPHY-MASS SPECTROMETRY (LC-MS)

#### E-1 The analysis of $\gamma$ -oryzanol by using LC-MS

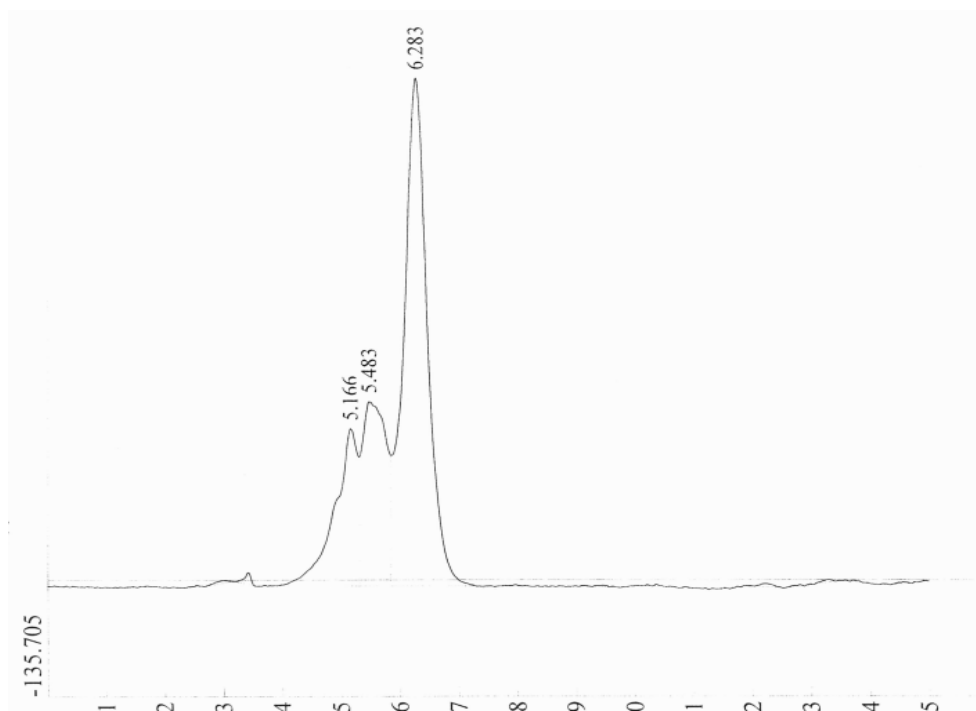
This analysis method was used to verify the peak of  $\gamma$ -oryzanol from collected fractions in the semi-preparative column chromatography. The peak standard of  $\gamma$ -oryzanol was analyzed by using RP-HPLC equipped with ELSD detector. The peak standard of  $\gamma$ -oryzanol appeared only one peak which was shown in Figure E-1.1.



**Figure E-1.1** The RP-HPLC of standard  $\gamma$ -oryzanol analyzed by RP-HPLC equipped with ELSD detector

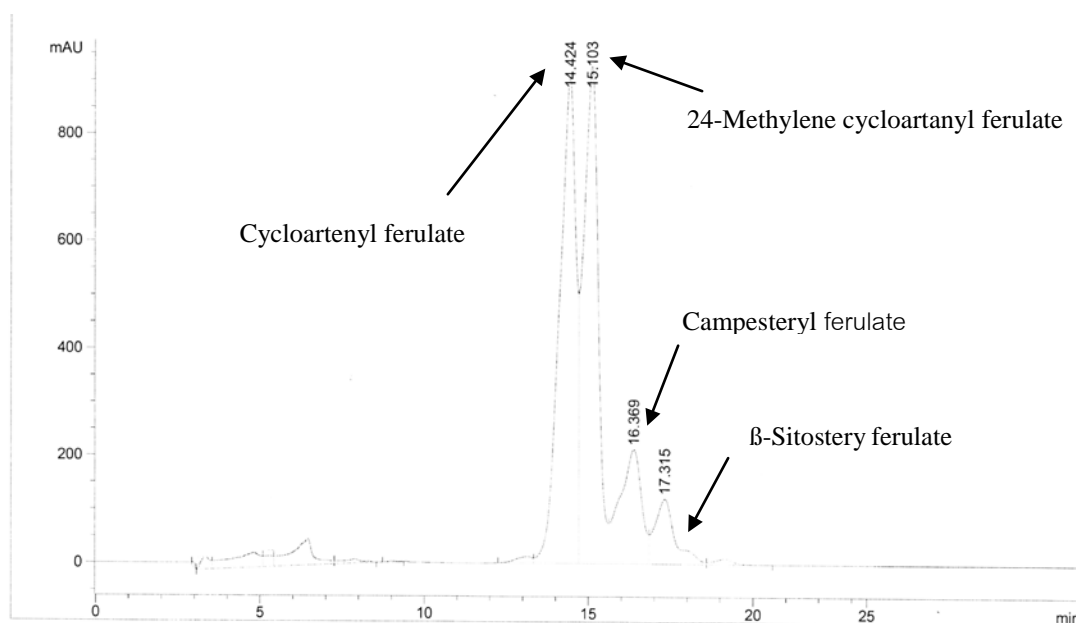
On the other hand, the results of the collected fractions from the semi-preparative column chromatography gave three main peaks. These peaks might be  $\gamma$ -

oryzanol. The RP-HPLC chromatogram shows in Figure E-1.2. Therefore in order to verify that three main peaks from the collected fractions are  $\gamma$ -oryzanol, the liquid chromatography-mass spectrometry (LC-MS) was used to analyzed these results.



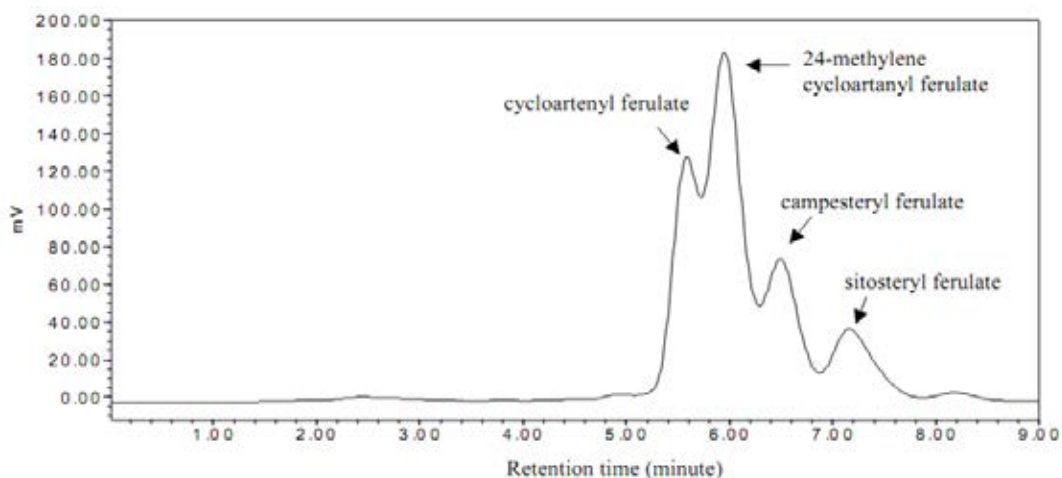
**Figure E-1.2** The RP-HPLC chromatogram of collected fraction from the semi-preparative column chromatography (Silica gel (25-40 $\mu$ m) 10 g, mobile phase: hexane/ethyl acetate (75/25 v/v), volume injection 1 ml and flow rate 1 ml/min)

The standard  $\gamma$ -oryzanol was analyzed by using the liquid chromatography-mass spectrometry (LC-MS). The C18 Varian of RP-HPLC equipped with diode array detector (320 nm) and mass spectrometry was used in this study. The mobile phase was the mixture of methanol and isopropanol (79:21 v/v) using 1 ml/min of flow rate. The peak standard of  $\gamma$ -oryzanol analyzed by RP-HPLC equipped with diode array detector was shown in Figure D-1.3. The result found that there were four main peaks appearing in the RP-HPLC chromatogram. The four peak components consisted of cycloartenyl ferulate, 24-methylene cycloartenyl ferulate, campesteryl ferulate and  $\beta$ -sitostery ferulate, respectively [Huang C. J.(2003) and Kumar R. R. et al.(2007)].



**Figure E-1.3** The RP-HPLC chromatogram of standard  $\gamma$ -oryzanol analyzed by RP-HPLC equipped with diode array detector (320 nm)

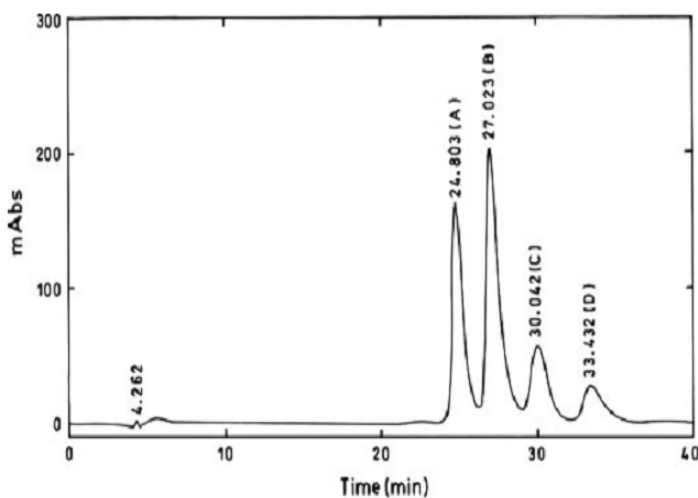
In 2003, Huang et al. suggests that standard of  $\gamma$ -oryzanol have four main components consisted of cycloartenyl ferulate, 24-methylene cycloartenyl ferulate, campesteryl ferulate and  $\beta$ -sitosteryl ferulate. These results were analyzed by using RP-HPLC equipped with UV detector at 330 nm. This research used isocratic elution mode eluting with the mobile phase mixture of methanol, acetonitrile, dichloromethane and acetic acid (50:44:3:3). The RP-HPLC chromatogram was shown in Figure E-1.4.



**Figure E-1.4** The RP-HPLC chromatogram of standard  $\gamma$ -oryzanol in mobile phase: methanol/acetonitrile/dichloromethane/acetic acid (50:44:3:3) by using UV detector at 330 nm (Huang et al., 2003)

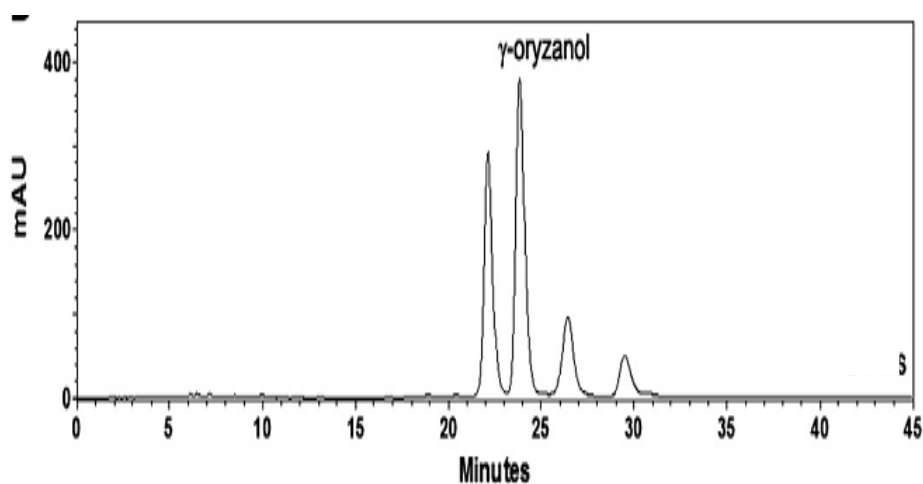
In 2007, Kumar et al. also analyzed the standard of  $\gamma$ -oryzanol. The RP-HPLC equipped with diode array detector 314 nm was used in their research. The research used gradient elution mode. The mobile phase mixture of methanol and acetonitrile were used. At the beginning, methanol 0% was used to eluting to 100% at 30 minutes then methanol was decreased back to 0% at 35 minutes and maintain for 5 minutes before next injection. The RP-HPLC chromatogram was shown in Figure E-1.5. The results found that there were four main peak components of  $\gamma$ -oryzanol. The four components were composed of cycloartenyl ferulate, 24-methylene cycloartanyl ferulate, campesteryl ferulate and  $\beta$ -sitosteryl ferulate. The components that get from Kumar et al.(2007) comprised the same components as that were found by Huang et al.' study in 2003.





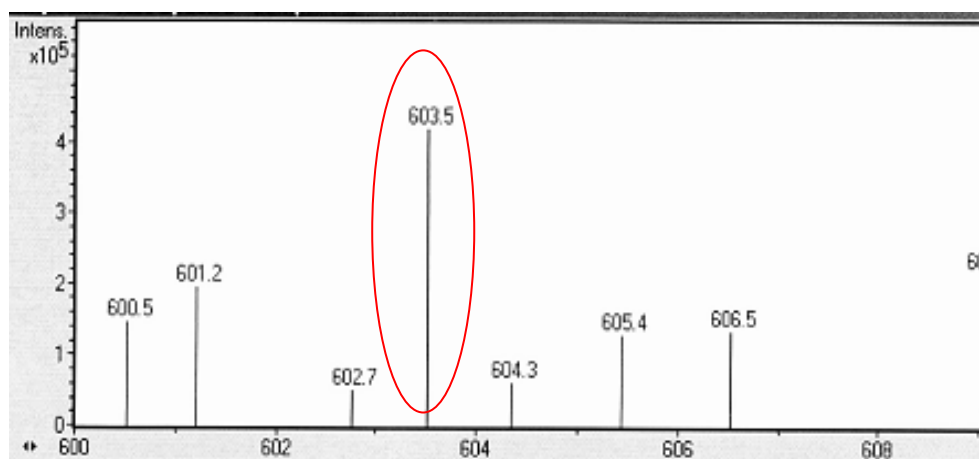
**Figure E-1.5** The RP-HPLC chromatogram of standard  $\gamma$ -oryzanol analyzed at 314 nm of diode array detector (Kumar et al., 2007)

Pascual et al. (2011) investigated components in standard  $\gamma$ -oryzanol by using RP-HPLC detecting with diode array detector at 325 nm. Pascual et al.' research used the gradient elution mode with the mobile phase mixture of acetonitrile, methanol and isopropanol. The initial composition of the mobile phase (45% acetonitrile, 45% methanol and 10% isopropanol) was held for 6 minutes. The mobile phase mixture was then followed by linear gradient to 25% acetonitrile, 70% methanol and 5% isopropanol in 10 minutes. The last composition was held for 12 minutes. The HPLC chromatogram shows in Figure E-1.6. The results found that there were four main peak components in standard  $\gamma$ -oryzanol. However, this research only examined the group of standard  $\gamma$ -oryzanol, this research did not verify each type of peak in standard  $\gamma$ -oryzanol.

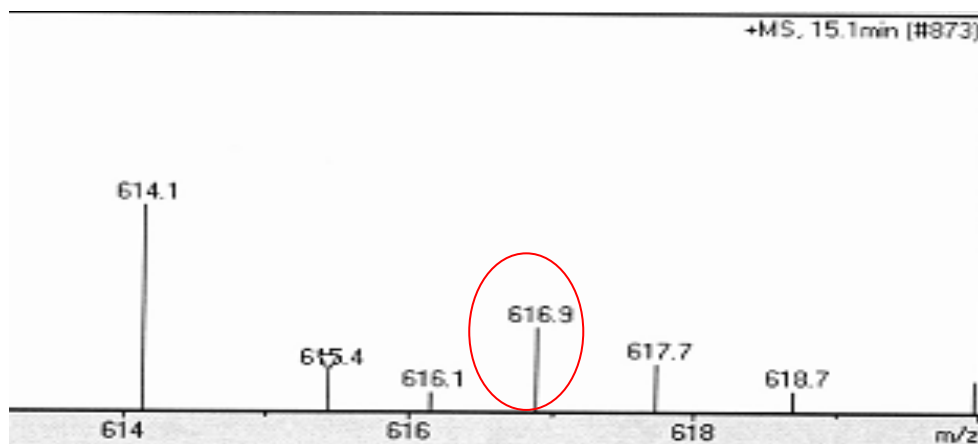


**Figure E-1.6** The RP-HPLC chromatogram of standard  $\gamma$ -oryzanol analyzed by diode array detector at 325 nm (Pascual et al., 2011)

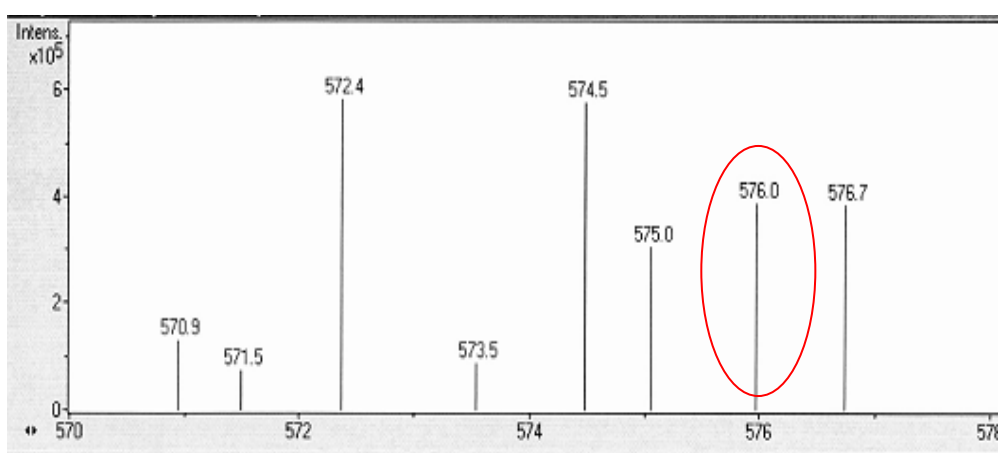
In order to prove those peak components appeared in standard  $\gamma$ -oryzanol (Figure E-1.3) are the group of  $\gamma$ -oryzanol. The mass spectrometry was used to determine molecular weight of each peak appeared in RP-HPLC chromatogram of  $\gamma$ -oryzanol standard. The mass spectrometry results show in Figure E-1.7.



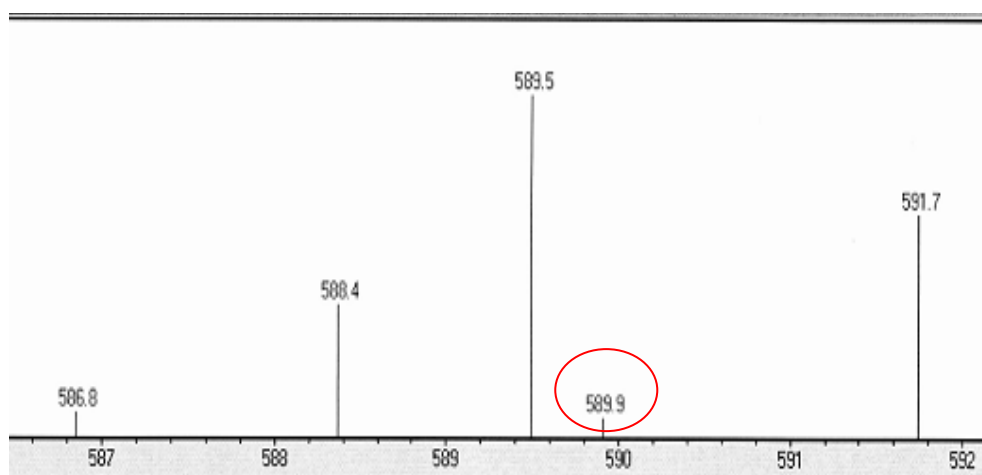
(a) Peak 1 (14.42 minutes) cycloartenyl ferulate (Molecular weight: 602-603)



(b) Peak 2 (15.10 minutes) 24-methylene cycloartanyl ferulate (Molecular weight: 616-617)



(c) Peak 3 (16.37 minutes) campesteryl ferulate (Molecular weight: 576-577)



(d) Peak 4 (17.32 minutes)  $\beta$ -sitostery ferulate (Molecular weight: 590-591)

**Figure E-1.7** The results of standard  $\gamma$ -oryzanol analyzed by mass spectrometry: (a) cycloartenyl ferulate, (b) 24-methylene cycloartanyl ferulate, (c) campesteryl ferulate and (d)  $\beta$ -sitostery ferulate

From Figure E-1.3, the results found that the first peak in Figure E-1.3 was cycloartenyl ferulate which has 603.5 of molecular wieght (Figure E-1.7(a)). The second peak was 24-methylene cycloartanyl ferulate which has about 616.9 of molecular weight (Figure E-1.7(b)) while the third peak found 571.7 of molecular weight which was campesteryl ferulate (Figure E-1.7(c)). The last peak was  $\beta$ -sitostery ferulate which has molecular weight approximately 189.9 (Figure E-1.7(d)). The molecular weight of each component was summarized in Table E-1.1. The molecular weight of these components were nearby the experiment of Roger E.J. et al. (1993) and the experiment of Miller A.et al.(2003). In 1993, Roger E.J. et al. analyzed the components of  $\gamma$ -oryzanol that were found in crude rice bran oil sample by using CI-MS. In 2003, Miller A. et al also studied the group of  $\gamma$ -oryzanol in order to analyze the group of component found in rice by using LC-MS. Those results were summarized in Table E-1.1.

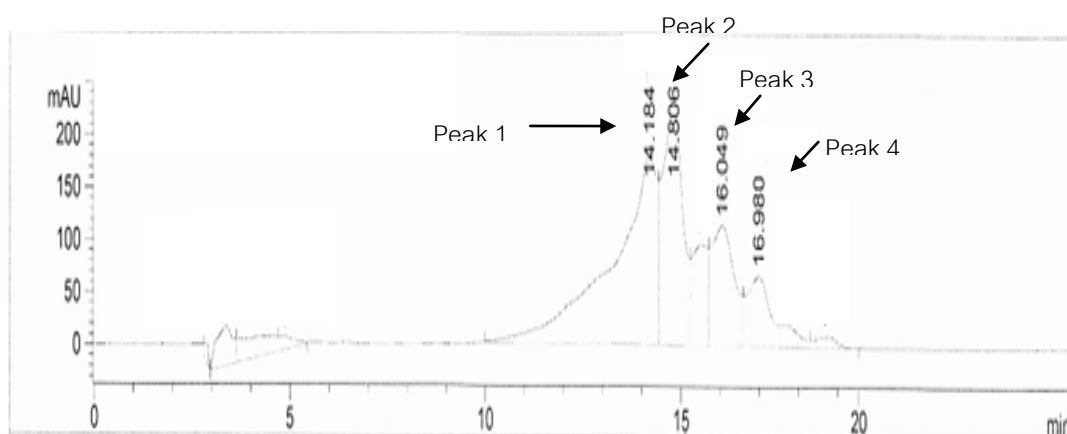
**Table E-1.1** The summary of molecular weight of each component

The order of RP-HPLC peak	$\gamma$ -oryzanol	Molecular weight <sup>a</sup>	Molecular weight <sup>b</sup>
Peak 1	Cycloartenyl ferulate 24-Methylene	603	602
Peak 2	cycloartanyl ferulate	617	616
Peak 3	Campesteryl ferulate	577	576
Peak 4	$\beta$ -Sitostery ferulate	591	590

a Roger et al.(1993) Crude rice bran oil sample (CI-MS)

b Miller et al.(2003) Rice (GC-MS)

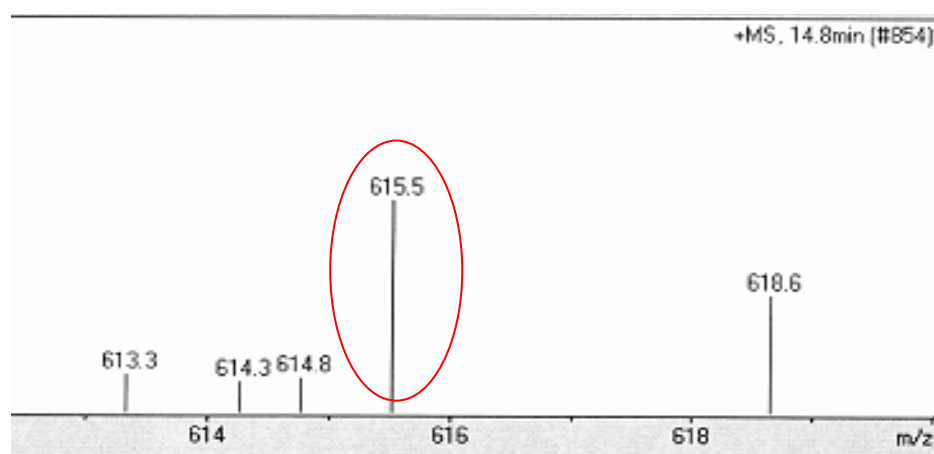
The collected fraction analyzed by RP-HPLC equipped with ELSD detector was shown in Figure E-1.2. The ELSD detector gave three main peaks of  $\gamma$ -oryzanol while the standard  $\gamma$ -oryzanol gave only one peaks of  $\gamma$ -oryzanol. In order to verify these three peaks were a group of  $\gamma$ -oryzanol, the RP-HPLC was used to analyzed by diode array detector at 320 nm. The result shows in Figure E-1.8. The result was then identify each peak appeared in Figure E-1.8 in order to determine molecular weight each peak by using mass spectrometry. The results of collected fraction which were analyzed by mass spectrometry show in Figure E-1.9.



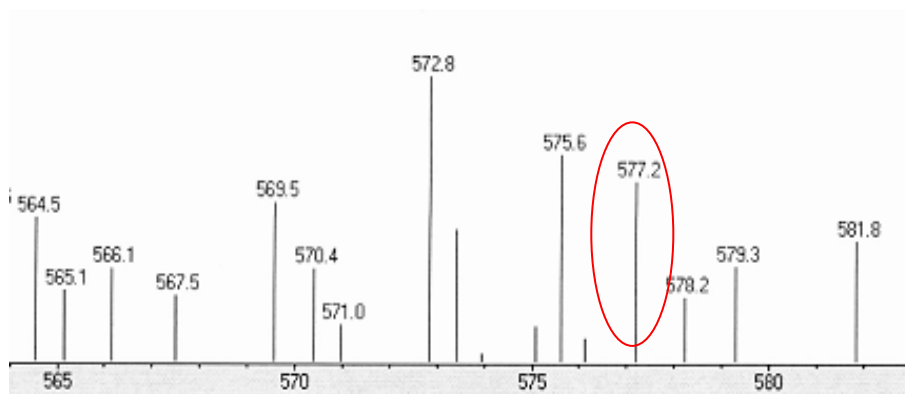
**Figure E-1.8** The RP-HPLC chromatogram of the collected fraction of  $\gamma$ -oryzanol analyzed diode array detector at 320 nm



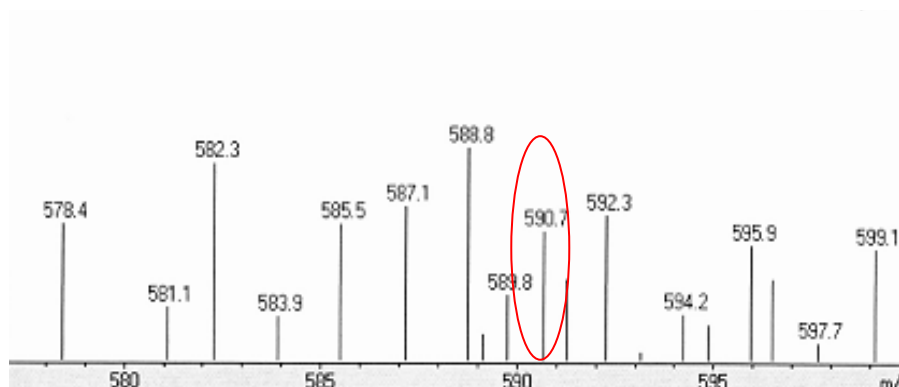
(a) Peak 1 (14.18 minutes) cycloartenyl ferulate (Molecular weight: 602-603)



(b) Peak 2 (14.81 minutes) 24-methylene cycloartanyl ferulate (Molecular weight: 616-617)



(c) Peak 3 (16.05 minutes) campesteryl ferulate (Molecular weight: 576-577)



(d) Peak 4 (16.98 minutes)  $\beta$ -sitostery ferulate (Molecular weight: 590-591)

**Figure E-1.9** The results from the collected fraction analyzed by mass spectrometry: (a) cycloartenyl ferulate, (b) 24-methylene cycloartanyl ferulate, (c) campesteryl ferulate and (d)  $\beta$ -sitostery ferulate

From Figure E-1.9, the four main peaks appeared in the purified  $\gamma$ -oryzanol fraction has the same mass spectrum with that of that of the  $\gamma$ -oryzanol standard (Figure E-1.7). The four main peak components consisted of cycloartenyl ferulate, 24-methylene cycloartanyl ferulate, campesteryl ferulate and  $\beta$ -sitostery ferulate. It was evidenced therefore the LC-MS results that, although the purified  $\gamma$ -oryzanol fraction

analyzed with HPLC with the ELSD has three main peaks (Figure E-1.2), while that of the  $\gamma$ -oryzanol standard contains only one peak (Figure E-1.1), have the same mass spectrum and thus the purified fraction is confirmed to be  $\gamma$ -oryzanol.



## VITA

Miss Anchana Anjinta was born in Bangkok, Thailand on November 27, 1988. She finished her secondary course from Bangkapi School in 2007. She continued her undergraduate study in Chemical Engineering at the Faculty of Engineering, Mahidol University and graduated in 2011. She has then enrolled in the Master's degree program in Chemical Engineering at Chulalongkorn University and has joined the Biochemical Engineering Research Laboratory since 2011. She completed her Master's degree study in October, 2013.