

Chapter 2

Literature Survey

2.1 Composite System

Composite is a materials system composed of a mixture or a combination of two or more micro or macro constituents that differ in form and chemical composition and which are essentially insoluble in each other (William, 1993). One acts as reinforcement and the other acts as the binder or matrix. The engineering importance of a composite material is that two or more distinctly different material combine together and possess properties that are superior, or important in some other manner, to the properties of the individual component and then give new materials with improved characteristics (Sedlacek, 1986). Modification may be required to improve one or more properties, to develop special characteristics such as flame retardancy or conductivity (Patel, 1992), or simply to reduce cost. The advantages that composite materials have to offer must be balanced against their undesirable properties which are usually attained at a given optimum composition (Frans, 1995). Some of the second components which are often added are mineral fillers to increase stiffness and dimensional stability but reduce toughness, elastomers to improve fracture toughness and impact resistance but lower the elastic modulus, and fibers to increase stiffness and strength (Termonia, 1994).

Many commercial polymeric materials available in the market are composites. Examples include polyblends and ABS materials, foams, filled poly (vinyl chloride) formulations used in such applications as floor tile and wire coatings (Murphy, 1996), filled rubbers, thermosetting resins containing a great variety of fillers and glass or graphite fiber-filled plastics. The application of the composites can be seen in table 2.1.

Table 2.1 Composite application.

Application	Structure
Aerospace	Space structure, Antennae
Aircraft	Pylons, Struts, Fairings, Access doors, Wing boxes, Frames, Stiffeners, Floor beams, Turbine, Blades
Helicopters	Transmission cases, Truss structures, Swash plates, Push rods, Rotor blades, Landing gear
Automotive	Engine blocks, Push rods, Frames, Piston rods, Battery plates,
Electrical	Brushes, Cables, Battery plates
Medical	Protheses, Wheel chairs, Orthofies
Sport Equipment	Tennis racquets, Skies and Poles, Fishing rods, Golf clubs, Bicycle flames
Others	Bearings, Chemical processing equipments, Abrasive tools

2.2 Polymer-Matrix Composites (PMCs)

Polymer are primary materials used due to their specific strength and modulus properties. Polymer matrix composites can be divided into two categories based upon their thermal properties, i.e. thermosets and thermoplastics. Most of the composites are made with thermoset matrices and, historically, these have been the first type used. Thermoplastic matrices have only been used in the late 70's and there is still much area to research.

2.2.1 Thermoset Matrices

Thermosets are materials that at some point during polymerization undergo a crosslinking reaction and chemically bond polymer chains together thus forming an infinite network. These crosslinks are normally not reversible and once the material is fully crosslinked it will not flow even at elevated temperatures, but degrades instead. The crosslinks can have other effects like eliminating crystallization and increasing the modulus in the rubber temperature region. The most widely used thermosets in composite system are unsaturated polyester and epoxies. Other resins used are phenolics, polyimides and polybenzimidazoles. These composites include cloth and paper in phenolic and urea-based resins, glass fibers in polyesters and metal in epoxies.

2.2.2 Thermoplastic Matrices

Thermoplastics are well known as the commodity plastics used in every day life. This includes polyethylene, polypropylene, nylons, polyesters. Thermoplastics do not have the crosslinks that are seen in the thermoset systems. This means that thermoplastics can flow at elevated temperatures. While this is a disadvantage for using them at high temperatures, it is an advantage for their processing. Thermoplastic can be quickly mass produced into various shapes using several techniques by raising the thermoplastic above its melting temperature, having them flow into a mold and then cooling them rapidly to a solid. The processing time compared to thermosets can be orders of magnitudes ; even with the fast cured thermosets. Mass production lines can produce a thermoplastic part in seconds where the fastest thermosetting cure takes at least 1-2 minutes and mostly takes more than 30 minutes. Early thermoplastic matrices were used with short fiber reinforcement, since the temperature limitations barred their use as high performance engineering materials. Recently materials have been developed that can withstand much higher temperatures, such as polyetheretherketone (PEEK) and polyphenylene sulfide (PPS).

2.3 Ceramic-Matrix Composites (CMCs)

Ceramic materials are usually produced from slurries or cast into shape from organic, often polymeric precursors. Ceramics tend to be very brittle and sensitive to flaws. Due to this weakness, ceramics are not often employed as engineering

materials. Ceramic matrices are used when their superior thermal properties are needed. The main types according to reinforcement are continuous-fiber, discontinuous-fiber, and particulate reinforced (William, 1993). Applications such as rocket nozzles, ram jets and jet turbines are very well suited for ceramic matrices. Applications which take advantage of the dimensional stability of these material are now being exploited. This has led to their use in several aerospace applications.

2.4 Metal-Matrix Composites (MMCs)

As the name implies, MMCs is a system which use metallic materials as the matrix. Metal-matrix composite materials have been so intensely investigated over the past years and many new high-strength-to-weight materials have been produced. They have been in use since the mid 70's when they were developed for the space shuttle. Their use has been limited primarily due to the density of metals, but composites of aluminum matrices and boron fibers are being used when both strength and temperature resistance are critical to the performance of the composite. Applications of MMCs are normally found in automobile engines and aerospace industries.

2.5 Particulate-filled Polymer Composites

Particulate composites are defined in terms of size, shape and concentration of the constituents and their roles in load bearing. A large number of composites

can be considered as belonging to this class. Particulate composites may be defined as follow:

a) They have components which are not noticeably one or two dimensional (as fibers or lamellae would be) but have similar dimension in all directions (and in some cases are spheres).

b) All spheres carry a proportion of the load

Particulate composites therefore form an intermediate class in between dispersion-hardened materials and fiber-reinforced ones. In case of former, the particles are very small and their proportion can be a few percent or up to 70% (Anthony, 1994). In fiber reinforcement, by contrast, the proportion of fibers is high and they are the main load bearers (Termonia, 1994).

Filled polymers represent a growth sector in the polymer field. Particulates inorganic fillers are commonly added to commercial thermoplastic and thermosetting resins to achieve economy and favorably modify certain properties, for example to enhance some mechanical properties, to increase dimensional stability and to control opacity and barrier properties. Calcium carbonate is one of the most favored additives because of its low cost. The performance of filled plastics is not defined by composition alone, however, there are other factors such as size of fillers, filler concentration and the adhesion between filler and polymer matrix (Schreiber *et al.*, 1990). Perhaps the most important changes observed are in the mechanical behavior of such composites.

Josef and Jaroslav (1990) suggested that in case of polymer matrix/inorganic filler, tensile yield stress depended on the filler content and mechanical properties of constituents, on shape and space packing of the filler particles, on the degree of interfacial adhesion, and also on the experimental conditions such as temperature and strain rate.

At higher filler loading, there is generally deterioration on the mechanical properties such as elongation, strength and toughness. The effect of agglomeration and the reduction in matrix effective cross sections due to the presence of filler was a reduction in fracture toughness. The matrix is constrained to a greater degree because of interaction with the filler surface and then leading to embrittlement of the materials (Jancar, Dibenedetto, and Dianselmo, 1993). In contrast, Nauman *et al.* (1988) showed that the toughness of numerous brittle polymer such as styrene-acrylonitrile copolymer(SAN), epoxides, polyimides and poly(phenylene ether) was improved without interfacial bonding between filler and matrix.

While mechanical properties are easily determined, the presence of fillers drastically affects the morphological structure of the matrix polymer such as the difference in the thermal expansion coefficients which will result in uneven stresses in the polymer matrix surrounding the filler particle (Chacko *et al.*, 1982).

When considering the general behavior of particle-filled plastics, it is convenient to consider the behavior of brittle glassy plastics, such as the epoxies and unsaturated polyesters separately from that of the tougher semi-crystalline plastics

such as polyethylene, polypropylene and nylon. The former generally have relatively low elongation to failure, of the order of a few percent, and low fracture energies of a few hundred $\text{J}\cdot\text{m}^{-2}$, while the latter have fracture strains which can be over 100% and fracture energies of the order of several tens of thousands of $\text{J}\cdot\text{m}^{-2}$.

2.5.1 Particle-filled Brittle Plastics

In tension and flexure, unfilled thermosets have fracture with little or no yielding at strains of the order of two or three percent. In compression and shear, they generally yield and are capable of relatively large amounts of plastic deformation before fracture. Addition of particulate fillers usually decreases the stress at which fracture occurs in tension and bending, increases the stress at yielding in compression and improves the elastic moduli (Phillips and Harris, 1977).

Roulin-Moloney, Cantwell and Kausch (1987) found that increasing filler volume fraction increases the modulus and toughness and gave casting with strength comparable to the matrix. Changing the filler particle size at constant volume fraction did not have significant influence on the modulus of the composite.

Increasing the filler modulus generally increase the modulus of resulting composite. This is clearly shown in figure 2.1 for an epoxy resin filled with silica, alumina and silicon carbide particles. The modulus of these fillers were 94, 320 and 469 GPa respectively. Similarly, increasing the modulus of the filler increased the stress intensity factor (K_{Ic}).

Phillips and Harris (1977) reported that the effect of the fracture surface energy was complex, and significant increases was able to obtain because the particles inhibited crack growth. The enhancement of the fracture energy of a brittle plastics by the addition of particulate fillers had important implications for strength by reducing its strength. The strength of a brittle solid was controlled by a combination of its surface energy, Young's modulus and the size of the fracture initiating flaw, through the Griffith equation

$$\sigma = \sqrt{\frac{2E\gamma_F}{\pi c}} \quad (2.1)$$

where γ_f is the fracture energy and c is the size of fracture initiating flaw. It can be seen that the size of the primary fracture flaw is the significant effect for strength of a brittle solid.

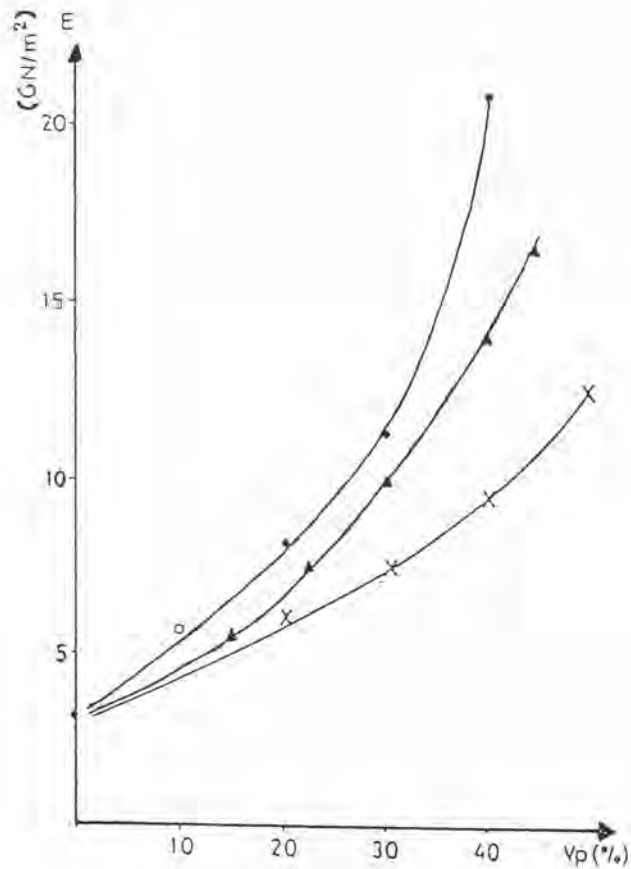

Figure 2.1 Flexural modulus as a function of volume fraction of filler

: x, silica ; ▲, alumina ; ●, silicon carbide

(Roulin-Moloney, Cantwell and Kausch, 1987).

2.5.2 Particulate-filled tough plastics

Addition of particulate to tough thermoplastics tends to reduce their toughness, but not always. In some cases, the addition of filler can increase the toughness (Fu and Wang, 1992). The tough plastics are intrinsically capable

of absorbing a great deal of energy during fracture, having values of fracture energy of 10^3 to 10^4 J·m⁻². During fracture of a tough plastic, numerous processes can take place (crack initiation, propagation, yielding, crazing), the number of which is further increased by the introduction of second component such as particulate filler (cavitation, voiding, debonding). The major factors in determining fracture energy are the properties of polymer matrix, the decrease of matrix material due to the incorporation of the second phase and the interaction of the matrix and the dispersed component. It is also clear that the most important energy absorbing process is plastic deformation. The stress field in front of the crack results in a debonding of the particles (Frans, 1995).

A possible explanation for crazing in filled thermoplastic is discussed by Chacko *et al.* (1983) and Friedrich and Karsch (1981) and this is shown in figure 2.2 (a), (b) and (c). Only a small amount of plastic strain is needed for the first step of damage. With further plastic strain the voids usually grow in the stress direction, forming dimple-like holds around the particles (step II). Subsequently, the stress concentrations would shift to the equatorial region since the void is nonreinforcing. A profile of the void would accelerate the formation of craze (step III).

Table 2.2 shows data for Nylon 66 and Nylon 66 containing 30 wt% of glass beads (Scott and Phillips, 1974). Addition of glass beads considerably reduced the tensile elongation at break and the impact energy, while the tensile strength was relatively unaffected and the compressive strength and stiffness were increased.

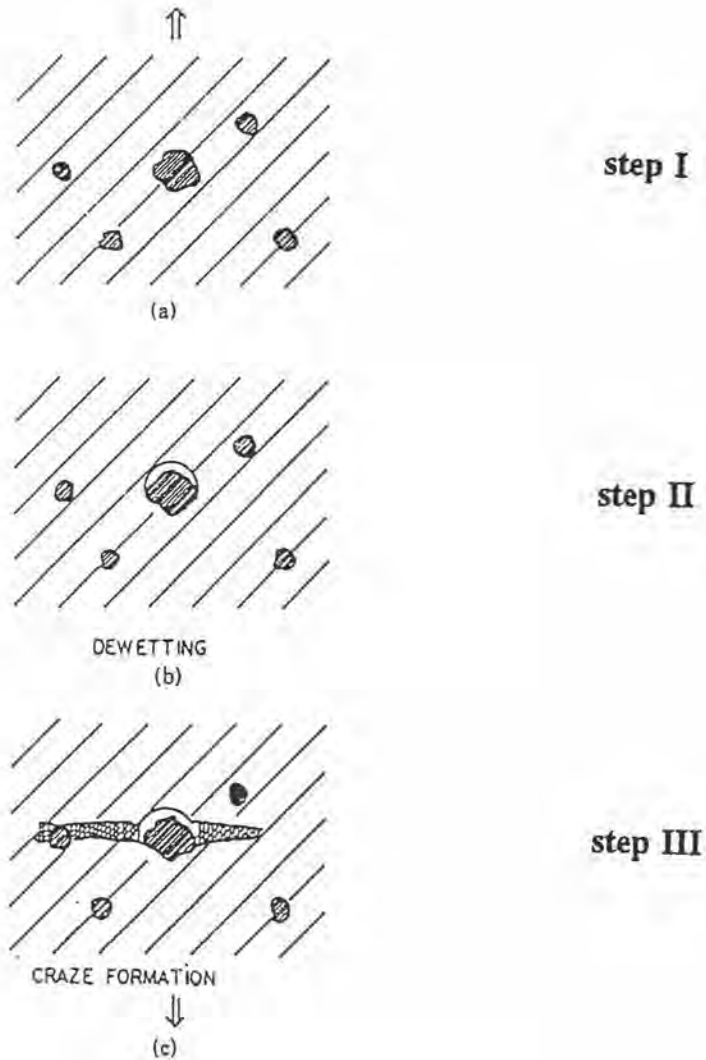

Figure 2.2 Schematic for proposed craze formation process in filled polyethylene : (a) initial configuration ; (b) dewetted particle ; (c) craze formation normal to the stress direction (Chacko, Farris and Karasz, 1983)

Figure 2.3 shows the general tensile deformation behavior of unfilled Nylon 66 (Scott and Phillips, 1974). At low loads the material was elastic, but as the load

is increased the load versus extension behavior became non-linear and some yielding occurred. The load reached a maximum at the upper yield stress. Then a period of homogeneous yielding which deformation occurred under a fairly constant load was reached. Deformation then became inhomogeneous with the formation of a neck which gradually extended into the the unnecked region (cold-drawing). Fracture finally occurred in a brittle manner in the necked region. Nylon 66 containing 30 % of glass spheres also exhibited an upper yield stress, but there was no necking and fracture occurred at a relatively low elongation (< 10 % compared with values in excess of 30% for unfilled Nylon 66).

Table 2.2 The mechanical properties of unfilled Nylon 66, and Nylon 66 containing 30 % of glass spheres (Scott and Phillips, 1974).

Property	Test Method	Nylon 66	Nylon 66 + filler
Tensile strength	ASTM D638-64T	72-79 MNm ⁻²	86-90 MNm ⁻²
Elongation at break	ASTM D638-64T	30-35 %	5-10 %
Impact energy	BS 306 B and C	7 J	1 J
Compressive strength	ASTM D695	83 MNm ⁻²	138 MNm ⁻²
Flexural modulus	ASTM D790-66	2.5 GNm ⁻²	2-4.5 GNm ⁻²

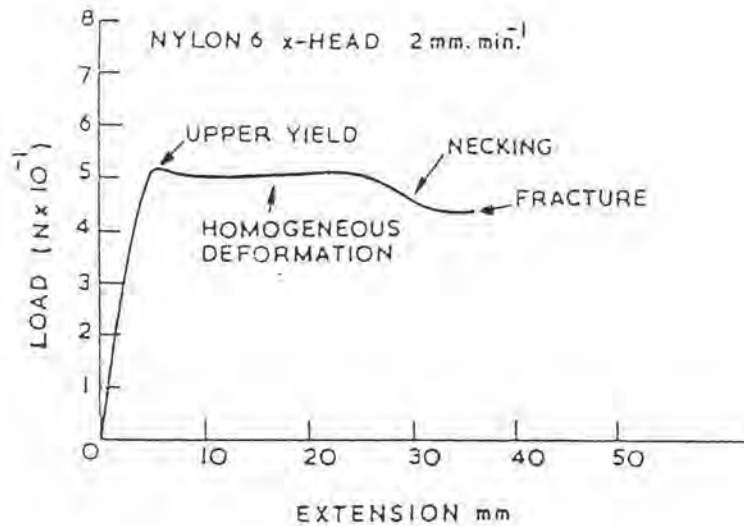

Figure 2.3 The tensile behavior of unfilled Nylon 66 (Scott and Phillips, 1974).

It is well known that the addition of filler can raise the elastic modulus of host polymer, however, filler can confer negative effects, notably in the non-linear range of polymer extension. The results for modulus and elongation at rupture are given in table 2.3.

Schreiber *et al.* (1990) reported that the modulus increased non-linearly with filler content, attaining a value some 40 % higher than the modulus of the unfilled polymer at 30 wt% CaCO_3 . On the other hand, there was a marked decrease in ductility. Relatively low quantities of filler already led to a decrease in the 30 to 40 percent range, while at higher loading, the compound ductility diminished rapidly toward the characteristics of brittle polymer.

Table 2.3 Mechanical properties of LLDPE filled with CaCO₃.(Schreiber *et al.*, 1990)

Compound	Modulus(E) (MPa)	Elongation(%)		
		E/E ₀	Er(%)	Er/(Er) ₀
LLDPE-control	270(±12)	1.00	360(±15)	1.00
+ 5% CaCO ₃	305	1.13	263	0.73
+ 8% CaCO ₃	335	1.24	216	0.60
+ 12% CaCO ₃	360	1.33	158	0.44
+ 20% CaCO ₃	370	1.37	75	0.21
+ 30% CaCO ₃	385	1.42	29	0.08

Lewis and Nielsen (1970) found that in the case of PP/CaCO₃ composite, the tensile yield stress of composite was reduced with increasing CaCO₃ volume fraction. This was because of the reduction of the effective cross section of the matrix in the loaded composite. This led to an increase in internal stress, at any given external loading, compared with the unfilled matrix. Stress concentration caused by the filler also contributes to the internal stress. Microplastic deformations occurred around particles which facilitated damage of the material at lower external load, compared with the unfilled PP. As a consequence of the different expansion coefficients, thermally induced internal stresses occurred around the filler particles. This contributed to an increase of the dewetting stress.

Figures 2.4 and 2.5 shows the effect of the addition of unmodified- CaCO_3 and phosphate modified- CaCO_3 in HDPE matrix on yield stress and ultimate elongation. CaCO_3 was treated with phosphate to increase the adhesion between filler and matrix. It was seen that addition of phosphate modified- CaCO_3 as well as unmodified- CaCO_3 to HDPE increased its tensile strength. As the modified- CaCO_3 content was more than 30 wt%, the yield strength was lower that of HDPE because of plastic deformation in the composites. Modified- CaCO_3 slightly increased its elongation at break up to 30 wt%, and unmodified- CaCO_3 decreased its elongation sharply. Moreover, there was an apparent difference in fracture surface. For unmodified- CaCO_3 , two phase morphology could be observed. For modified CaCO_3 , however, the two phase structure disappeared. In addition, the influence of using coupling agent on poly(phenylene oxide)/glass bead composite was also investigated by Wambach *et al.* (1968) ; Trachte and Dibenedetto (1971).

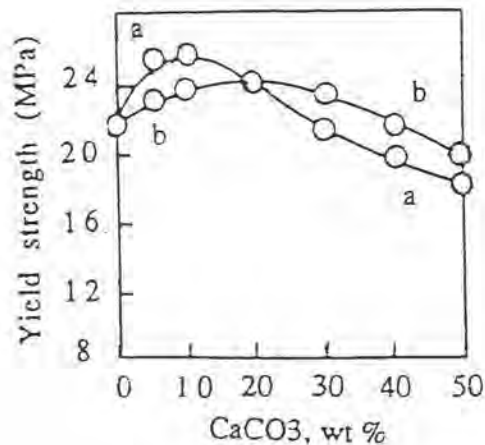

Figure 2.4 Yield stress of the HDPE/ CaCO_3 composites as a function of CaCO_3 content. (a) HDPE/modified- CaCO_3 ; (b) HDPE/unmodified- CaCO_3 (Fu and Wang, 1992).

Then, Fu and Wang (1993) concluded that the stronger interphase adhesion making the stress transport in the matrix more uniform ; hence, the easier the yielding propagation in the matrix. When treat CaCO_3 with phosphate, the better contact between CaCO_3 and HDPE matrix occurred. This resulted in the flexible interfacial area which had a lower stiffness than matrix. The stress could be transferred through the interface, then the strength and toughness of the composite were improved.

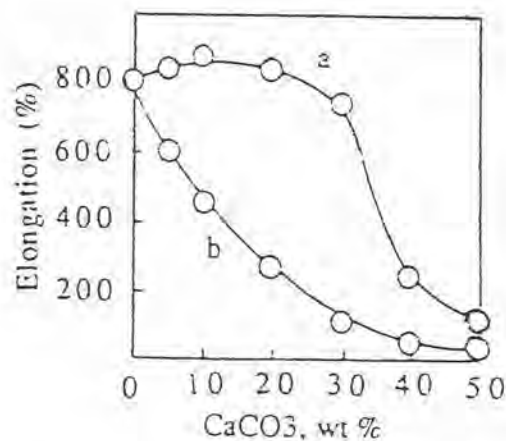

Figure 2.5 Ultimate elongation of the HDPE/ CaCO_3 composites.

(a) HDPE/modified- CaCO_3 ; (b) HDPE/unmodified- CaCO_3

(Fu and Wang, 1992).

2.6 Influence of Annealing

Annealing implies heating a solid to temperatures approaching its melting point. This activates internal mobility and promotes greater stability by, for example, elimination of internal stresses or defects in a general movement towards the thermodynamic equilibrium condition (Bassett, 1981). Compare to small molecule

crystals, polymer crystals have many more defects and their parameters of the crystal unit cells and the density of the crystalline region are easy to vary to a certain extent. When a polymer is annealed within its melting range, the process occurred is a consequence of its becoming partly molten and then recrystallizing within the surrounding matrix.

Spells and Hill (1991) suggested that when annealed at heating rate around $10\text{ }^{\circ}\text{C min}^{-1}$, to attain the annealing temperature, it was convenient to consider annealing in three temperature regimes. In the first stage, there was no change in long period, although other structural changes occurred. In the intermediate regime, a localized solid state thickening process occurred. In the third temperature region (highest temperature), there was partial melting. These processes caused the crystallinity, crystallite size and other crystalline parameters of polymers approached "optimization" and subsequently better mechanical properties of polymer such as tensile strength and elastic modulus were achieved.

Polyolefins have been the frequent subject of morphological study. Bulk polyethylene crystallizes in a spherulitic morphology, composed of alternating crystalline lamellae and amorphous regions (figure 2.6). Lamellae containing folded chains which held together by "tie molecule" which go from one crystalline layer to another. Therefore, chain ends and molecular imperfections tend to collect in the amorphous portion between crystalline lamellae and result in low strength. Strength comes primarily from the tie molecule. El-kindi and Schreiber (1992) studied the influence of morphological variable caused by

annealing process on thermal and mechanical properties of LLDPE. Annealing was done at temperature between 60 and 100 °C for 6, 22, 30 and 42 hours. In case of thermal properties, the melting temperature increased with increasing annealing temperature because the order regions of the polymer became enormous thicker crystallites.

Figures 2.7 and 2.8 illustrate the variation of yield strength and initial modulus of the polymer respectively with the crystallinity increment. The yield strength increased with crystallinity. The highest slope was obtained when the annealing temperature is 80 °C where could be assumed that the lamellae crystallites acted as reinforcing entities within the non-crystalline matrix of the polymer.

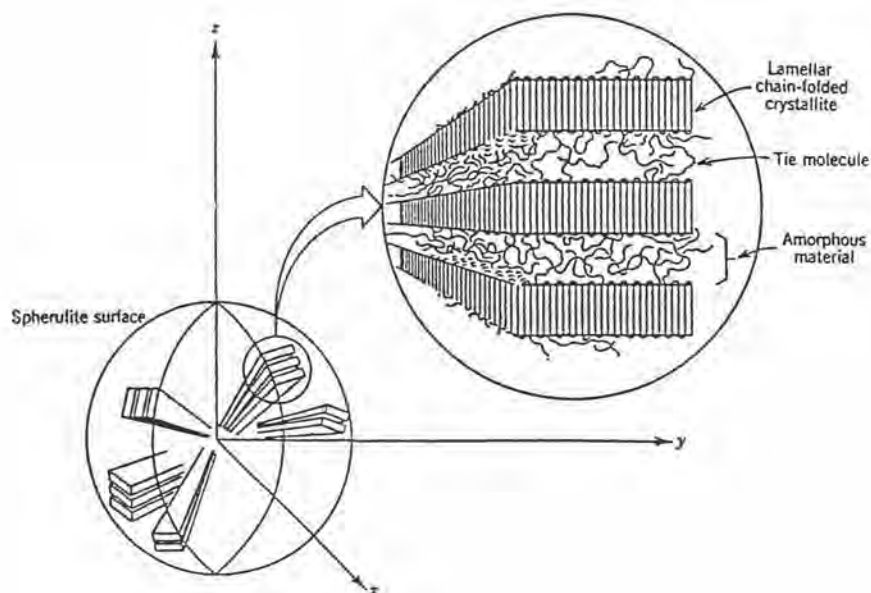

Figure 2.6 Schematic spherulitic structure (William, 1996)

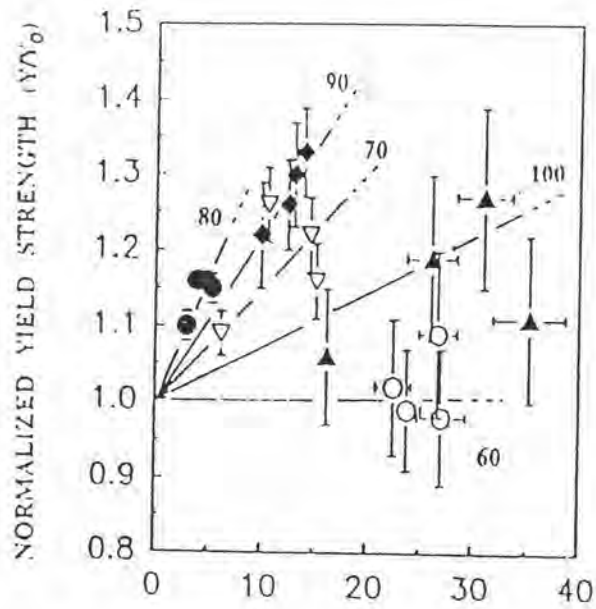

Figure 2.7 Normalized yield strength as function of crystallinity increment

: numbers indicate annealing temperatures.

(El-kindi and Schreiber, 1992)

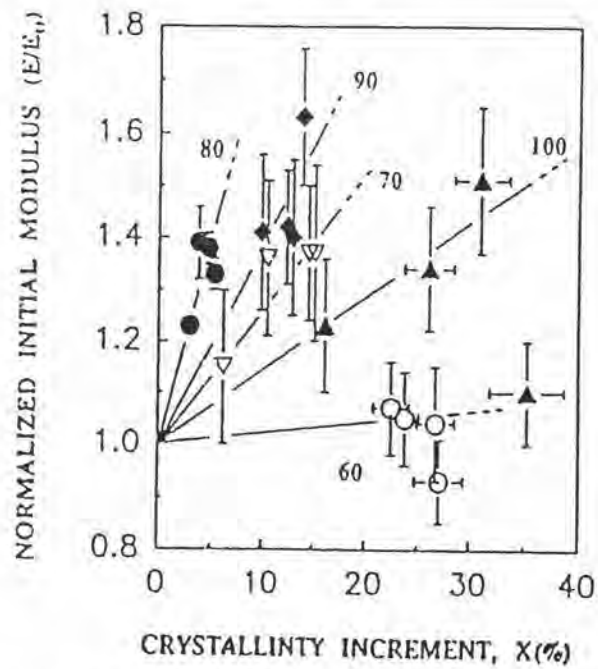

Figure 2.8 Normalized initial modulus as function of crystallinity increment

: numbers indicate annealing temperatures.

(El-kindi and Schreiber, 1992)

2.7 Theoretical Models in Particulate-filled Polymers

Addition of rigid particles to polymer matrix can produce a number of desirable effects such as an increase in stiffness, fracture toughness, etc. Thus, the use of reinforced polymeric materials has been growing steadily in the engineering applications. It is important to have a physical understanding of polymer-filler interactions so that the best models can be developed for use although the mechanical behavior in terms of the two components to the mechanical properties is complicated.

This complication arises from complexities of filler concentration, uncertainties in filler size distribution complicated by any agglomeration and in the magnitude of interaction. The extent of void formation occurred during fabrication and the imperfect interfacial adhesion between the matrix and filler also result in the complication of developing model for composite system. Nevertheless, theories to describe the mechanical properties of particulate-filled polymers have been developed, with often one theory applying to one situation better than another.

2.7.1 Tensile Modulus

The Young's modulus of filled materials has been represented by a large number of equations. One of the earliest theories for a composite system is based on Einstein's equation (Einstein, 1906). He has considered rigid-spherical

nonsolvated particles in a newtonian viscous fluid, and he expressed the viscosity, equivalent to modulus in the form

$$M_R = 1 + aV_f \quad (2.2)$$

where M_R is the relative modulus, and V_f is the filler volume fraction. The constant a is equal to 1 when there is zero adhesion between filler and matrix. When there is a perfect adhesion, the constant a is 2.5.

Guth (1945) generalized the Einstein concept by introducing a particle interaction term. He considered that due to the similarity in the equation of elasticity and those of hydrodynamics, it was permissible to use the approach of Einstein's equation as a basis for considering the effect of carbon black particles in rubber. Guth considered both the viscosity and modulus of elasticity and found the ratios of either the coefficient of viscosity or the moduli of elasticity of the filled to unfilled material to be

$$M_R = 1 + 2.5V_f + 14.1V_f^2 \quad (2.3)$$

where V_f represents the filler volume fraction.

One of the most versatile and elaborate equations for a composite materials consisting of spherical particles in the matrix is due to Kerner (1956). This assumes that fillers are much more rigid than the polymer matrix, assuming good adhesion between the phases. The equation is written as

$$M_R = 1 + \frac{V_f}{V_m} \left[\frac{15(1 - \nu_m)}{8 - 10\nu_m} \right] \quad (2.4)$$

where ν_m is the Poisson ratio of the matrix material and V_f and V_m are the volume fraction of filler and matrix respectively.

For the special case which the matrix and filler, respectively, taken on values of Poisson's ratios of 0.5 and 0.25, Van Der Poel (1958) has reported the following equation which has found some application

$$M_R = 1 + \left(\frac{1.25V_f}{1 - 1.28V_f} \right)^2 \quad (2.5)$$

Thomas's equation (1965) is a semi-empirical relationship based on data generated with monodispersed spherical particles

$$M_R = 1 + 2.5V_f + 10.05V_f^2 + A \text{Exp}(BV_f) \quad (2.6)$$

where coefficient A and B are 0.00273 and 16.6 respectively.

Lewis and Nielsen (1970) then showed how the equation can be generalized still further to

$$M_R = \left[\frac{1 + ABV_f}{1 - B\psi V_f} \right] \quad (2.7)$$

The values of A and B for any Poisson's ratio of the matrix (ν_m) are defined as

$$A = \frac{7 - 5\nu_m}{8 - 10\nu_m} \quad (2.8)$$

and

$$B = \frac{M_2/(M_1 - 1)}{M_2/(M_1 + A)} \quad (2.9)$$

where M_2 and M_1 are the modulus of filler and matrix respectively. The factor ψ depends upon the maximum packing fraction (ϕ_m) of the filler. Two empirical functions are

$$\psi = 1 + \left(\frac{1 - \phi_m}{\phi_m^2} \right) V_f \quad (2.10)$$

and

$$\psi V_f = 1 - \text{Exp} \left[\frac{-V_f}{1 - \left(\frac{V_f}{\phi_m} \right)} \right] \quad (2.11)$$

The values of ϕ_m for different packing of spheres and aligned rods were listed in table 2.4. A relation taking into account the effect of adhesion efficiency between the two phases has been suggested by Sato and Furukawa (1962) and is expressed by

$$M_R = \left[\left\{ 1 + \frac{1}{2} \frac{Y^2}{1-Y} \right\} \left\{ 1 - \frac{Y^3 k (1+Y-Y^2)}{3(1-Y+Y^2)} \right\} - \frac{Y^2 k (1+Y-Y^2)}{3(1-Y)(1-Y+Y^2)} \right] \quad (2.12)$$

where $Y = V_f^{1/3}$ and k is an adhesion factor, taking the value of zero for perfect adhesion and the value of 1 for zero adhesion.

Table 2.4 Maximum packing fraction, ϕ_m (Nielsen, 1974)

Particle	Type of Packing	ϕ_m
spheres	Hexagonal close packing	0.7405
"	Face centered cubic	0.7405
"	Body centered cubic	0.60
"	Simple cubic	0.5236
"	Random close packing	0.637
"	Random loose packing	0.601
Fibers	Parallel hexagonal packing	0.907
"	Parallel cubic packing	0.785
"	Parallel random packing	0.82
"	Random orientation	0.52

2.7.2 Tensile Strength

The theories for the strength of particulate composites are less developed than that for the moduli because of the complexity of fracture mechanisms such as the fracture modes, the nature of the polymer-filler adhesion and the particle size and shape. Tensile strength normally increases as particle size decreases. The reason for this phenomenon is not entirely clear, but the increase in interface area per unit volume of filler as particle size decrease must be an important factor.

Nielsen (1966) has introduced a model for estimating the ultimate tensile strength for the case of poor bond between the filler and matrix, as follow;

$$\sigma_{cu} = \sigma_{mu} (1 - V_f^{\frac{2}{3}}) K \quad (2.13)$$

where a stress concentration factor (K) takes the value between 0.5 to 1.0. σ_{cu} and σ_{mu} are the ultimate tensile strengths for the composite and the matrix respectively and V_f is the volume fraction of the filler.

Nicolais and Narkis (1971) considered a cubic matrix filled with uniformly dispersed spherical particles where fracture was assumed to occur in the minimum cross-section of the continuous phase which was perpendicular to the applied load. The equation can be written as

$$\sigma_{cu} = \sigma_{mu} (1 - 1.21 V_f^{\frac{2}{3}}) \quad (2.14)$$

According to Schragger model (1978), a volume of matrix is associated with each embedded spherical particle, which is affected by the presence of the embedded particle. The equation proposed by Schragger is

$$\frac{\sigma_{cu}}{\sigma_{mu}} = \text{Exp}(-\gamma V_f) \quad (2.15)$$

where experimental constant γ was found to be equal to 2.26.

2.8 Compounding process

The need of new application areas of polymeric materials results in increasing modified the properties of polymer to produce high performance or added value polymer systems. This may be achieved by incorporating additives such as fillers and reinforcements, by blending polymers of differing chemical composition and physical characteristics or by controlled morphological tailoring by a reactive process.

The basic aim of any compounding process is to mix together two or more different materials into a single homogeneous mass with uniform composition. The correct choice of compounding machinery will depend on a number of factors related to the nature of constituent materials. The mechanism involved in continuous compounding operations is to bring together controlled ratios of the constituent materials and to induce physical motion of the ingredients in such a

manner that mixing occurs. With high viscosity liquids, such as polymer melts, the motion induced is primarily connective and mixing occurs by laminar flow.

Twin screw extruders are being used preferentially for a wide variety of polymer compounding operations. Janssen and Smith (1976) presented four different types of twin screw extruders. The screws could rotate in the same or in the opposite directions (co-rotating or counter-rotating extruders). In either case the screws could be intermeshing or non-intermeshing (figure 2.9). In particular, co-rotating twin screw extruders are being used in preference to counter-rotating twin screws due to their greater mixing efficiency and their ability to process heat or shear sensitive polymers.

Non-intermeshing twin screw extruders can be regarded more or less as two single screw machines with some interaction. With intermeshing screws, the process fluid is displaced positively from hopper to die in C-shape chambers which are moved by the screw rotation. The nature of flow and leakage in co-rotating twin screw extruder is determined by the geometry of the intermeshing zone between two screw forms.

Arising from the need for an advanced form of co-rotating twin screw compounding extruder particularly suited to the processing of polymer systems incorporating high filler loadings and heat or shear sensitive additives, the BTS series of closely intermeshing co-rotating twin screw extruder have been developed

by Betol Machinery Limited (Brenner, 1987). The major structural features of this type of extruder are shown in figure 2.10.

Inherent in the design of the extruder is the high torque characteristic of the processing screws generated by judicious gear design. The high torque capability allows high shear stresses to be used which are needed for the intensive mixing action required for dispersive mixing in highly filled compounds. Accordingly, twin screw extruders are often claimed to have good flow mixing and residence time distribution characteristics. Control of residence time and enhanced dispersive mixing is achieved by the use of staggered mixing barrier elements and a variety of forms of kneading elements.

Abram *et.al.*(1984) reported on the importance of the processing route for obtaining high toughness and high modulus particulate reinforced composites. In this study a co-rotating twin screw compounding extruder was able to prepare highly filled compounds (based on a high density polyethylene (HDPE) matrix filled with particulate calcium carbonate) more quickly and with less damage to the molecular structure of the HDPE matrix phase when compared with compounding on a two roll mill.

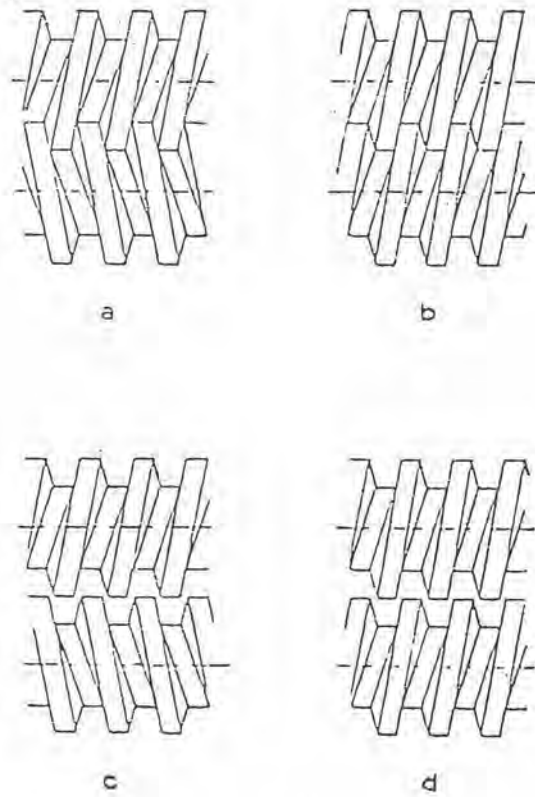

Figure 2.9 Different twin screw extruders a) intermeshing counter-rotating
b) intermeshing co-rotating c) non-intermeshing counter-rotating
d) non-intermeshing co-rotating (Janssen and Smith, 1976)

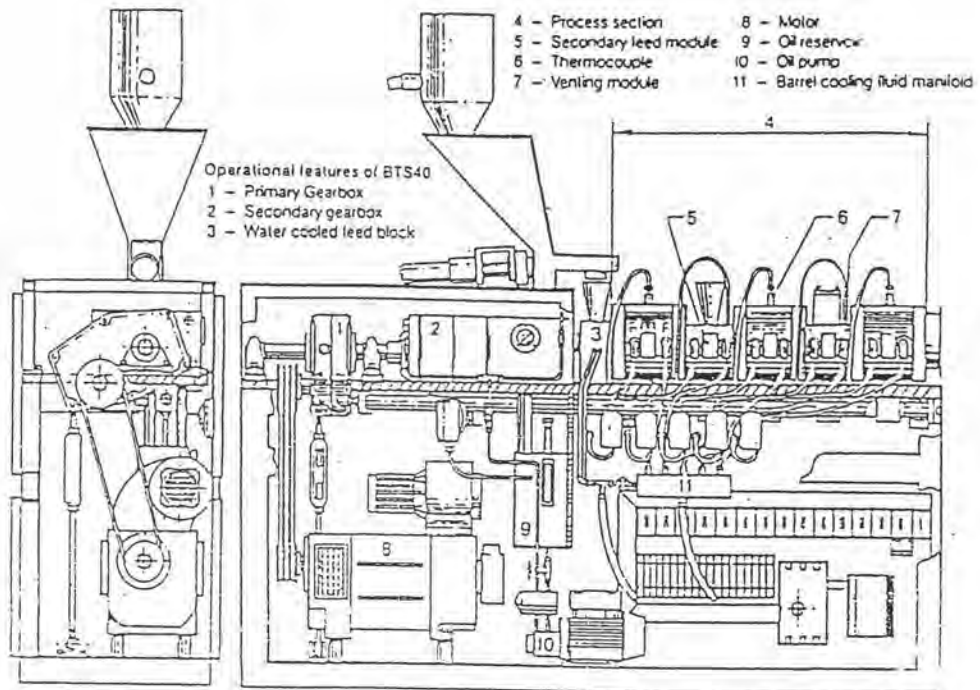

Figure 2.10 Constructural features of BTS extruder (Brenner, 1987).