

CHAPTER II

LITERATURE REVIEW

2.1 Nylon 6,6

2.1.1 Basic Principle of Nylon

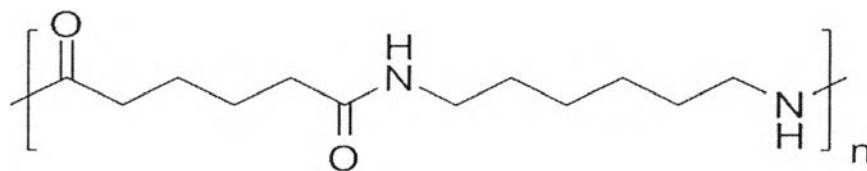

Figure 2.1 Polyamide or Nylon 6,6 Structure (Bernstein et al., 2005)

Nylon is a common polymeric material used for product of things, ranging from stockings, clothing, carpets, automotive components, hot air balloons, toothbrush and studied since it was first synthesized by *DuPont*. The Nylon of specific interest for this study is Nylon6,6. The simplified synthetic scheme involves the condensation polymerization of adipic acid and 1,6 hexanediamine (Bernstein *et al.*, 2005) The mechanical and physical properties of Nylon 6,6 are strongly dependent on hydrogen bonding force between the carbonyl oxygen and the amide hydrogen atoms within the polymer chain. Water media has a very dramatic effect on these bonding forces and as a result, significantly modifies its properties.(Abdelbary *et al.*, 2013) Furthermore, All nylons are considered hygroscopic. This means that they can absorb or release moisture based on environmental conditions. Nylon is more hydrophilic property when compared with other polymers. (Savarino *et al.*, 2000)

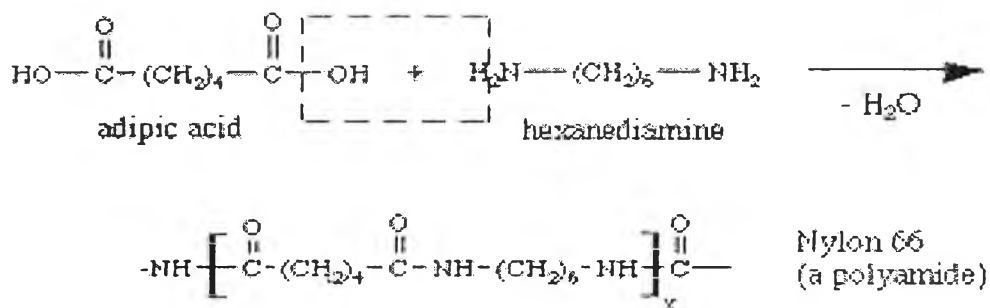

Figure 2.2 Preparation of Nylon 6,6 or Polyamide

2.1.2 Literature Review of Nylon

Pappas et al., (2006) study about modification of the fibers were plasma treat with a frequency of 90 kHz, leading to the functionalization of the surface through the addition of new reactive chemical groups such as $-\text{COOH}$ and $-\text{OH}$ and changing the energy, chemical composition and wettability of the surface the improvement of the hydrophilic character of the surface as the water contact angle measured after the plasma treatments significantly decreased. The corresponding changes of the total surface energy were evaluated with a dynamic contact angle analysis system revealing a significant increase due to the exposure that can be mainly attributed to the increase of its polar component. Preliminary XPS results show a significant increase in oxygen content with the addition of carboxylic and hydroxylic groups and a decrease in the carbon content of the surface. Most importantly, the plasma modified nylon fibers and films exhibit a stable wetting behavior.

Zhu et al., (2007) study the influence of the amount of absorbed moisture in nylon fibers during atmospheric pressure plasma (DBD) treatment and the existence of moisture in the substrate material may have a potential influence on the treatment effect. In this study, nylon 6 fibers with three different moisture regains (1.23, 5.19 and 9.70%) were treated by atmospheric pressure to improve the wettability and dyeing properties of fibers. The scanning electron microscope showed that at 9.70% moisture regain, the surface layer of the fibers was partially peeled off after plasma treatment. X-ray photoelectron spectroscopy analysis

indicated that the plasma-treated fibers had higher oxygen concentration than the control fibers. In dynamic contact angle measurement, the advancing contact angles of all three treated groups decreased about 12° , while the groups with 5.19 and 9.70% moisture regains had lower receding contact angles than the group with 1.23% moisture regain. Using acid dye and dispersive dye, respectively, greater dye uptake was observed in treated fibers whereas the dye depths of the two dyes in nylon fibers were not affected by plasma treatment. The dyeability of the treated fibers with 1.23% moisture regain was a little better than that of the other two treated groups. In addition, no significant difference in single fiber tensile strength was found among control and treated fibers (Zhu *et al.*, 2007)

Cui *et al.*, (2005) Study of the surface modification of a nylon-6,6 film processed in an atmospheric pressure air dielectric barrier discharge with nylon-6,6 film has been treated using an atmospheric pressure air dielectric barrier discharge (DBD). The resultant surface modifications were studied using X-ray photoelectron spectroscopy (XPS), contact angle measurement and secondary ion mass spectrometry (SIMS). The surface oxidation arising in the DBD discharge increase found in the hydrophilicity of the surface post-treatment is in the main believed to be associated with the earlier outcome and more polarity. Partial recovery of the surface contact angle values is found for the treated samples following extended storage in ambient air. The final contact angle obtained for the treated samples was 50° still reduced significantly from that of 83.5° the untreated material

2.2 Chitin

2.2.1 Basic Principle of Chitin

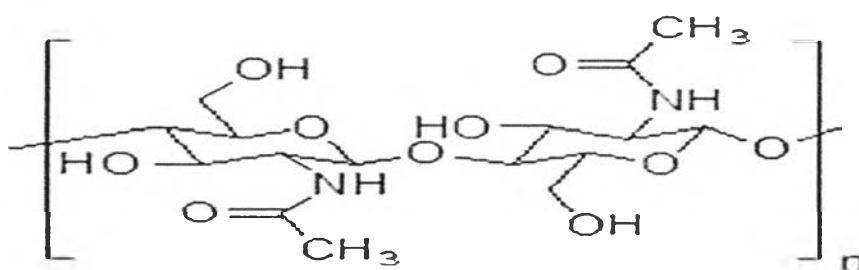

Figure 2.3 N-Acetyl-D-Glucosamine or Chitin Units.

Chitin is the main component in the shrimp shells. The main chitin sources are the shell of shrimp, prawn, krill, crab and lobster also found in exoskeletons of mollusks and insects, and in the cell walls of some fungi and algae. Arthropod shells (exoskeletons) are the most easily accessible sources of chitin. These shells contain 20-50% chitin on dry weight basis. Chitin occurs associated with other constituents such as lipids, protein, pigment and calcium carbonate. A shell of crustaceans such as crabs and shrimps are conveniently available as wastes from seafood processing which are easy to find to use as a raw material in the synthesis of chitin. In addition, chitin is readily available and cheap, and it also has the distinctive properties which are biocompatibility, biodegradable and non-toxic. Chitin is a high-molecular weight linear polymer and consist of *N*-acetyl-D-glucosamine (*N*-acetyl-2-amino-2-deoxy-D-glucopyranose) units linked by β -D (1 \rightarrow 4) bonds. It is a highly insoluble material resembling cellulose in its solubility and low chemical reactivity. It may be regarded as cellulose with the hydroxyl at position C-2 replaced by an acetamide group in chitin. (Peniche *et al.*, 2008) Like cellulose, it naturally functions as a structural polysaccharide. Chitin is a white, hard inelastic, nitrogenous polysaccharide and the major source of surface pollution in coastal areas industries. This has led to considerable scientific and technological interest in chitin and chitosan as an attempt to utilize these renewable wastes.

Many reviews and articles have been published covering the applications of chitin and its derivatives in the areas of pharmaceutical and medical applications, paper production, textile dyeing and finishing, fiber formation, wastewater treatment, biotechnology, cosmetics, food processing, and agriculture (Dunn *et al.*, 1997). Chemical structures of chitin and chitosan are showed in figure 2.4

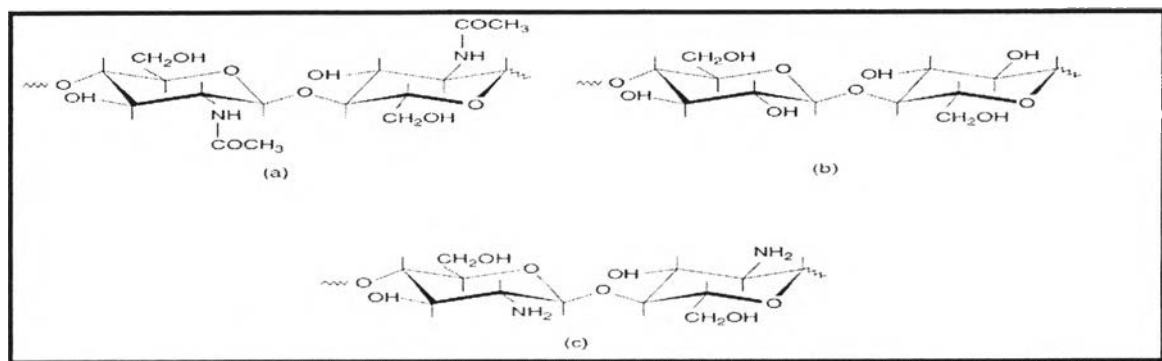

Figure 2.4 (a) chitin (b) Cellulose and (c) chitosan

2.2.2 Preparation of Chitin

α -chitin is produced commercially from crab and shrimp shells, which contain calcium carbonate and protein as the two major components. Pigments are also contained in small quantities. Furthermore, the chitin molecules are assumed to have polypeptide side chains attached covalently to some of the C-2 amino groups through amide linkages. Chitin is the most stable substance against acid and alkali among these components and not is soluble in ordinary solvents.

The shell are first cleaned and treated with 1N hydrochloric acid at room temperature to remove calcium carbonate. The decalcified shell are then cut into small flakes or are pulverized and then heat in 4% w/w NaOH(sodium hydroxide) in 85 - 90°C to decompose the protein and pigments. Chitin is obtained as almost colorless to off-white powdery material. There are some free amino groups besides acetamide group, and the degree of deacetylation for the isolated chitin is around 0.1. Proteases may be used to remove some of the proteins under mild conditions.

2.2.3 Literature Review of Chitin

2.2.3.1 Biomedical Application of Chitin

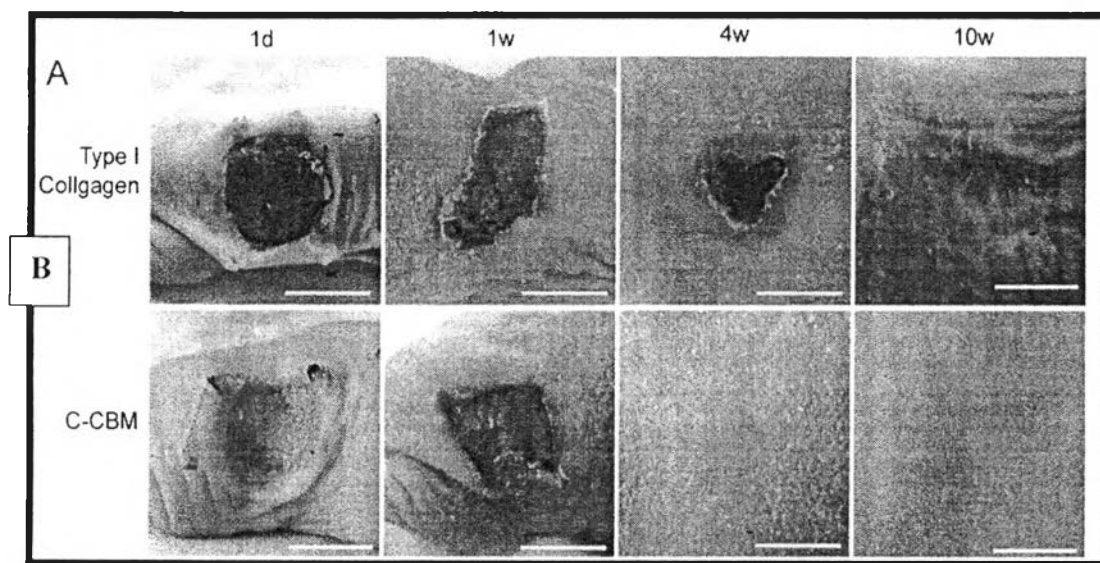

Figure 2.5 (A) Collagen (B) Chitin-collagen biomimetic membrane (C-CBM)

Shen Y. et al., (2014) that experimental observation of nude mice full-thickness defect model dressed with type I collagen only and another one has chitin and collagen(C-CBM), at 1 d, 1 w, 4 w, and 10 w. Type I, collagen alone shows that wounds are much slower to heal. Type B, chitin with collagen or C-CMB shows the repaired wound skin in the control group was relatively thin and heliotrope with a tendency to bleed. Furthermore, in vivo experiments showed more obvious hair follicle cell proliferation in the full-thickness skin defect nude mice. That analysis can explain that chitin contribute for wound recovery.

2.3.3.2 Mechanical Properties of Chitin Fiber Composites

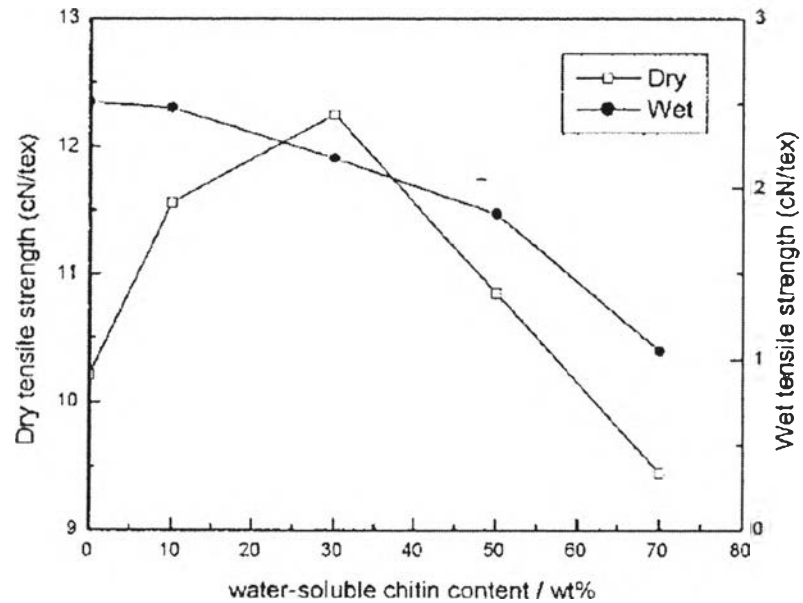

Figure 2.6 The Tendency of Tensile Strength with Chitin Content

L. Fan et al.(2005) evaluated the water-soluble chitin content of Alginate/Water-Soluble Chitin Blend Fibers with mechanical tensile strength the result shown that tensile strength of wet state of material decreased when chitin content increased and tensile strength of dry state of material increased until 30 wt% chitin content and then tensile strength dropped lower than wet state at the same chitin content so it can conclude high chitin content can reduce tensile strength of Aginate-Chitin fibers.

2.3 Plasma

2.3.1 Basic Principle of Plasma

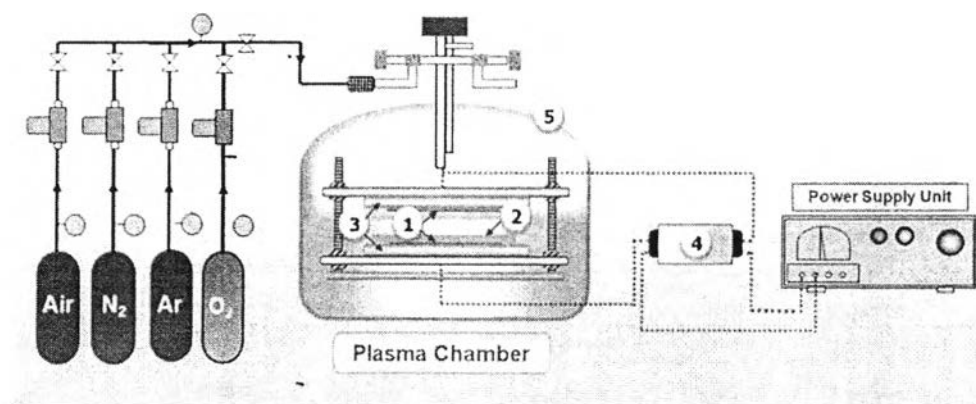

Figure 2.7 Experimental Setup of The DBD system: (1) Electrode Plates (stainless steel plates), (2) Dielectric Plate (glass plate), (3) Acrylic Plates, (4) High Voltage Transformer, and (5) Plasma Chamber

Plasma is ionized gas. It consists of positive and negative ions, electrons, as well as free radicals. The ionization degree can vary from 100% (fully ionized gas) to very low values (partially ionized gas). The plasma state is often referred to as the fourth state of matter: solid, liquid, gas, and plasma (Keatch, 1996). It is a collection of free charged particles moving in random directions that is, on the average, electrically neutral ($n_e \approx n_i$) (see Figure 2.8 a).

Plasma can occur in nature. Lightning and Auroras Borealis are the most common natural plasma observed on Earth (Fridman *et al.*, 2007) However, plasmas can be generated artificially at laboratory levels for practical applications. It is understood that a continuous source of energy is required to generate and sustain a state of matter. Man-made plasmas are commonly generated and sustained using electrical energy and are often referred to as ‘discharges’. A simple discharge is shown schematically in Figure 2.8 b. It consists of a voltage source that drives current through a low-pressure gas between two parallel conducting plates or electrodes. The gas “breaks down” to form a plasma, usually weakly ionized which is

the plasma density only a small fraction of the neutral gas density (Lieberman and Lichtenberg, 2005).

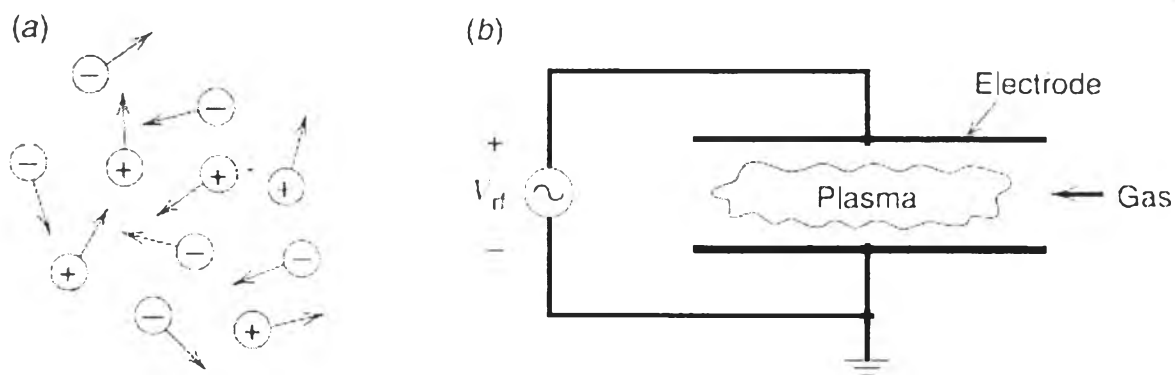
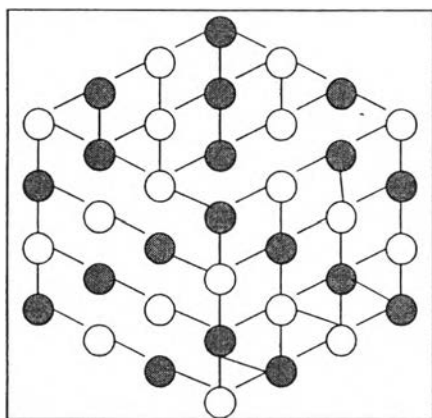
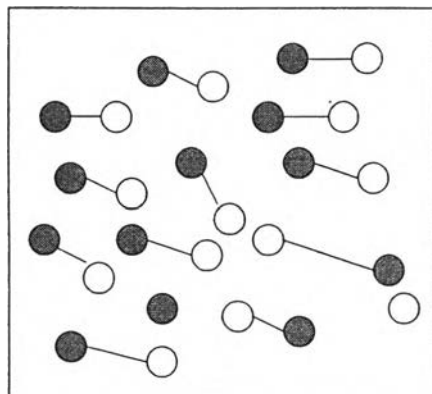

Figure 2.8 Schematic view of (a) a plasma and (b) a discharge.

There are four steps of plasma forming (Lieberman, and Lichtenberg, 2005).



1.) Solid state. At very low temperatures, matter is in a solid state with the atoms arranged in well-



2.) Liquid state. When temperature increases above a critical value, solids melt and become a liquid. The grid of atom is broken, but molecular bonds are maintained.

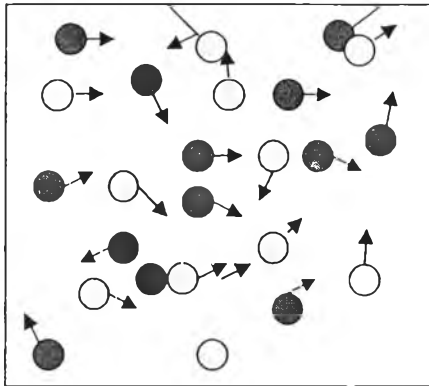

3.) Gas state. A liquid heated above a second critical temperature turns into a gas. The molecules in the gas decompose to form a gas of atoms that move freely in random directions

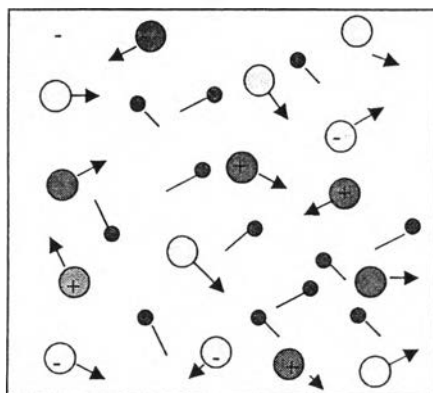

4.) Plasma state. If the temperature is further increased, then the atoms decompose into freely moving charged particles (electrons and positive ions), and the substance enters the plasma state.

In general, plasmas are realized by the generation of free electrons that make the gas conductive. These electrons obtain energy from the electric field and further ionize, excite, and dissociate gas molecules via energy transfer during collisions. This makes plasmas very reactive. Also, plasmas possess higher temperatures and energy densities in comparison with most other chemical processes, which make them interesting and efficient for various applications. They can be generated over a wide range of pressures with different electron temperatures and densities. Most applied plasmas have electron temperatures between 1 – 20 eV ($1 \text{ eV} \approx 1.6 \times 10^{-19} \text{ Joule} \approx 11600 \text{ K}$) and densities between $10^6 - 10^{18}$ (electrons/cm³) (Fridman and Kennedy, 2004).

2.3.2 Plasma Generation

The ionization of the gases is accomplished by applying an energy field using one of three source frequencies regulated by the federal government :

- Low-frequency (LF, 50–450 kHz)

- Radio-frequency (RF, 13.56 or 27.12 MHz)
- Microwave (MW, 915 MHz or 2.45 GHz)

The power required ranges from 10 to 5000 watts, depending on the size of the reactor and the desired treatment (Shishoo, 2007).

Frequencies selected for the energy field source are controlled by international agreements to prevent use of source frequencies, which would interfere with worldwide communication bands. Low frequency is the least expensive method of energy field generation. Unfortunately, Low frequency is also the least efficient method for cleaning action and surface modification to the manufacturers. This frequency scores low on all counts. So, RF or MW frequency sources are used in plasma manufacturers. MW source plasmas are generated downstream or in a secondary environment. Downstream is defined as the plasma generated in one chamber and drawn by a vacuum differential into the work area or another chamber. Though this can be advantageous for organic removal from ion sensitive components it also produces a less homogeneous process resulting in the compromising of uniformity across the work area. In surface modification the effective depth of the modification is tens of nanometers so the uniformity of the process becomes increasingly important, rendering MW source plasmas a less desirable choice. RF plasmas exhibit significantly higher levels of vacuum ultraviolet radiation (VUV), which in part explains the higher concentrations of electronically charged particles than found in other plasma sources. RF plasmas have also been noted to be more homogeneous, a trait that is critical in treating irregularly shaped and overly large objects (Nickerson, 1998).

2.3.3 Classification of Plasma

Plasma states can be divided in two main categories: thermal plasmas (equilibrium plasmas) and non-thermal plasma or cold plasma (non-equilibrium plasmas).

2.3.3.1 Thermal plasma or equilibrium plasma

As the name suggested, thermal plasmas are 'hot'. They have high gas temperatures (usually $> 10,000$ K). Thermal plasmas, an essential condition for the formation of this plasma is sufficiently high working pressure and low electric fields. In this type, the electron temperature (T_e) is approximately equal to neutral temperature (T_n), ($T_e \approx T_n$). These plasmas are usually sustained at high power densities (power input per unit volume) and have low chemical selectivity. The main drawbacks of using thermal plasmas for plasma chemical applications are the overheating of reaction media when energy is uniformly consumed by the reagents into all degree of freedom and, thus, high energy consumption required to provide special quenching of the reagents. Etc. They are obviously of no interest to textile manufacturers (Fridman and Kennedy, 2004). Lightning and thermal arc discharges are examples of naturally occurring and artificially generated thermal plasmas, respectively.

2.3.3.2 *Non-thermal plasma or non-equilibrium plasma*

While Non-thermal Plasma include low-pressure direct current (DC) and radio frequency (RF) discharges (silent discharges), and discharge from fluorescent (neon) illuminating tubes. Thermal condition of electron temperatures (T_e) is extremely higher than neutral temperatures (T_n), ($T_e > T_n$). The free electrons are very hot indeed, with typical temperatures ranging from 10,000 to 50,000 K, but the rest of the system, the ions and neutrals, is at or near room temperature. Because the free electrons comprise much, much less than one million of the total mass of the system, they have negligible heat capacity, so that the actual heat content of the plasma is low. However, those hot, high energy electrons are keys to the power of plasma in its ability to change surfaces. They career madly around the plasma volume, colliding with the other microscopic components and generating a wealth of new microscopic species with chemical and physical energy. They operate at low power densities, but have very good chemical selectivity. This plasma can be classified into several types depending upon their generation mechanism, their pressure range, and the electrode geometry. An example of non-thermal plasma is glow discharges, the operating pressures are normally less than 1 kPa and have electron temperatures of the order of 10^4 K with ions and neutral temperatures

approaching room temperature (Fridman and Kennedy, 2004) and (Shishoo, 2007). And other types of this plasma are auroras, radio frequency discharge, microwave discharge, corona discharge, and dielectric-barrier discharge (DBD), which the latter is used in this study.

2.3.4 Type of Non-Thermal Plasma

It is customary to divide non-equilibrium plasmas into distinctive groups, depending on the mechanism used for their generation, their pressure range, or the electrode geometry. In this section, the most notable characteristics of the following six non-thermal discharges are listed:

2.3.4.1 Glow discharge

The glow discharge is stationary and low-pressure discharge, usually generated between flat electrodes. The glow can be produced by applying a potential difference between electrodes in a gas. According to a more descriptive physical definition: a glow discharge is the self-sustained continuous DC discharge having a cold cathode, which emits electrons as a result of secondary emission mostly induced by positive ions. A schematic drawing of a typical normal glow discharge is shown in Figure 2.9. An important distinctive feature of the general structure of a glow discharge is large positive space charge and strong electric field with a potential drop of about 100 to 500 V. The thickness of the cathode layer is inversely proportional to gas density and pressure. If the distance between electrodes is sufficiently large, quasi-neutral plasma with a low electric field, the so-called positive column, is formed between the cathode layer and anode. The positive column of a glow discharge is the most traditional example of weakly ionized, non-equilibrium, low-pressure plasma (Fridman and Kennedy, 2004).

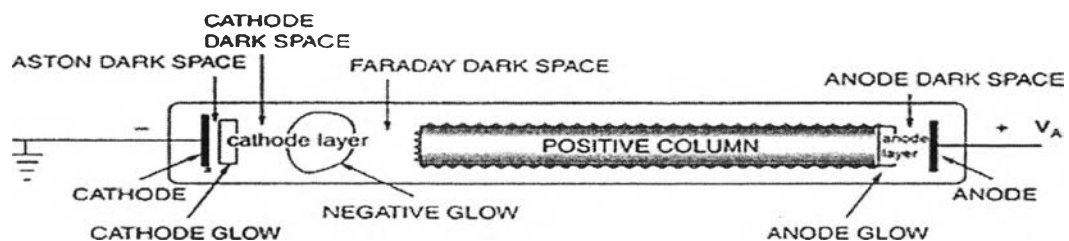

Figure 2.9 General structure of a glow discharge (Fridman and Kennedy, 2004).

One reason for the popularity of glow discharges is the comparatively low voltage and current needed to run them. It has become an important laboratory tool for plasma chemical investigation. In the lighting industry, the neon tubes used for outdoor advertising and the fluorescent tubes are examples of practical applications of glow discharges. However, the too low pressure and the resulting low mass flow, the glow discharge has not been used for industrial production of chemicals.

2.3.4.2 Radio Frequency discharge

The radio frequency (RF) discharges are used extensively in the laboratory to produce plasmas for optical emission spectroscopy and for plasma chemical investigation. RF discharges can be classified into two types according to the method of coupling the RF power with the load: capacitive coupling and inductive coupling. Figure 2.10 shows the setup typically consists of an RF generator, a matching network, and an antenna of capacitive coupling (Chu and Liu, 2008). RF discharges work well at low pressure, but are used also at atmospheric pressure. Low-pressure RF discharges for etching purposes have found widespread applications in semiconductor manufacturing. As long as the collision frequency is higher than the frequency of the applied field, the discharge behaves very much like a dc discharge. This implies that non-equilibrium conditions can be expected at low pressures, whereas thermal plasmas are generated at about atmospheric pressure.

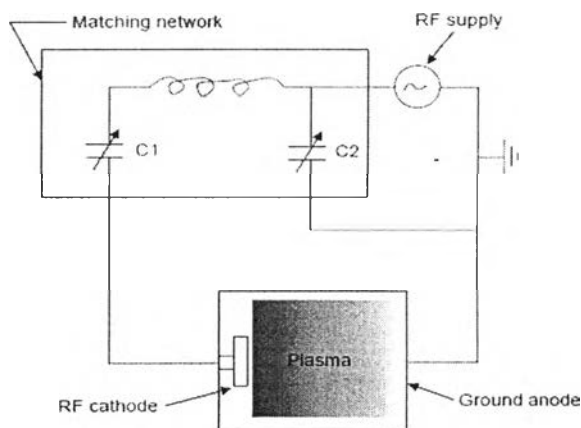

Figure 2.10 Schematic diagram of a capacitively-coupled plasma (CCP) plasma source with an equivalent electrical circuit.

2.3.4.3 Microwave discharge

The plasma is contained in a dielectric tube of a few centimeters diameter and is sustained by an electromagnetic wave, which uses only the plasma column and the tube as its propagating media. They can operate over a large frequency and pressure range and can produce large-volume non-equilibrium plasmas of reasonable homogeneity. Plasma columns of up to 4-m length have been thus produced. Due to the large pressure range, under which these discharges can be operated, electron densities between 10^8 and 10^{15} cm^{-3} have been reported. Applications so far have been limited to elemental analysis and lasing media. The ease of operation and the possibility of imposing a gas flow make these discharges attractive also for plasma chemical investigations. An example of Microwave discharge as shown in Figure 2.11

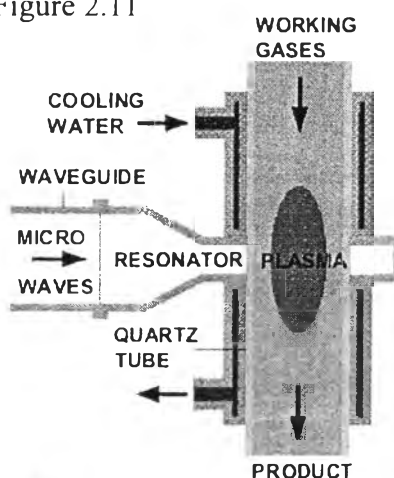

Figure 2.11 Schematic drawing of Microwave discharge.

(http://www.plasma.inpe.br/LAP_Portal/LAP_Site/Figures, 17 April 2009)

2.3.4.4 Gliding arc discharge

The gliding arc discharge is a non-thermal plasma technique, which has least two diverging knife-shape electrode. These electrodes are immersed in a fast flow of feed gas. A high voltage and relatively low current discharge are generated across the fast gas flow between the electrodes (Fridman, 1999). During the gliding arc evolution the plasma goes through a variety of different states and these phases of the gliding arc are shown in Figure 2.12

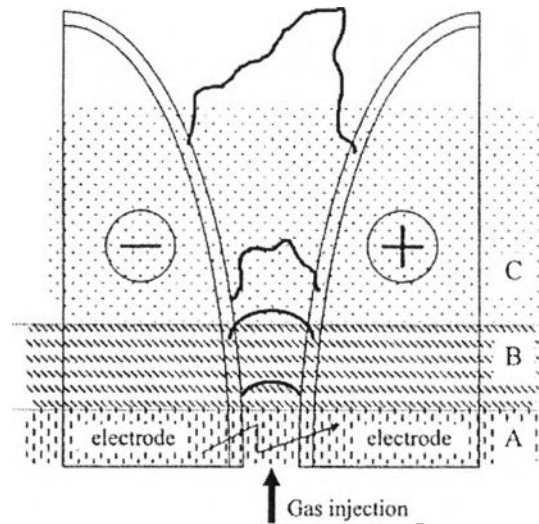

Figure 2.12 Phases of gliding arc evolution: (A) initial gas break-down; (B) equilibrium heating phase; (C) non-equilibrium reaction phase.

The initial break-down (A) of the processed gas begins the cycle of the gliding arc evolution. The high voltage generator provides the necessary electric field to break down the air between the electrodes and the discharge starts at the shortest distance (1–2 mm) between the two electrodes (Fridman *et al.*, 1999).

The equilibrium stage (B) takes place after formation of a stable plasma channel. The gas flow at a velocity of about 10 m/s and the length of the arc column increase together with voltage (Fridman *et al.*, 1999).

The non-equilibrium stage (C) When the length of the gliding arc exceeds its critical value, heat losses from the plasma column begin to exceed the energy supplied by the source, so it is not possible to sustain the plasma in the state of thermodynamic equilibrium. As a result, the discharge plasma rapidly cools to the gas temperature (about $T_0 = 2000$ K) while the plasma conductivity is maintained by a high value of the electron temperature $T_e = 1$ eV (about 11,000 K). After the decay of the non-equilibrium discharge, there is new breakdown at the shortest distance between electrodes and the cycle repeats (Fridman *et al.*, 1999).

2.3.4.5 Corona Discharge

Corona discharges are plasmas that result from the high electric field that surrounds an electrically conductive spatial singularity when a

voltage is applied. Corona generation systems usually take the form of two opposing electrically conductive electrodes separated by a gap containing the gas from which the plasma is generated and connected to a high voltage source. Corona discharge differs from glow discharge (weak current) and arc discharge (high current) with respect to the flow of current. The high electric field around the singularity, i.e. the point of the needle or the wire, causes electrical breakdown and ionisation of whatever gas surrounds the singularity, and plasma is created, which discharges in a fountain-like spray out from the point or wire (Shishoo, 2007). One way of stabilizing the discharge at high pressure is the use of inhomogeneous electrode geometries, e.g. a point electrode and a plane, such as in Figure 2.13, or a thin wire.

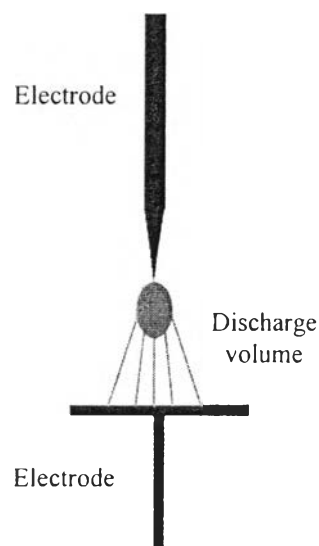

Figure 2.13 The corona discharge-inhomogeneous discharge at atmospheric pressure.

2.3.4.6 Dielectric Barrier Discharge

A dielectric barrier discharge (DBD) is generated in the space between two electrodes, each of which is covered with an insulating, dielectric coating. Sometimes dielectric-barrier discharges are also called silent discharges because of the absence of sparks that are accompanied by local overheating, generation of local shock waves, and noise (Fridman and Kennedy, 2004). A DC, AC, or pulsed high voltage is applied to the electrodes, which stimulates electron

emission from the instantaneous cathode. These electrons avalanche to form a filament across the gap. DBD plasma has inherent advantages over the discharges, which have been treated until now. It combines the large volume excitation of the glow discharge with the high pressure of the corona discharge. The main elements of dielectric barrier discharge configuration are shown in figure 2.14

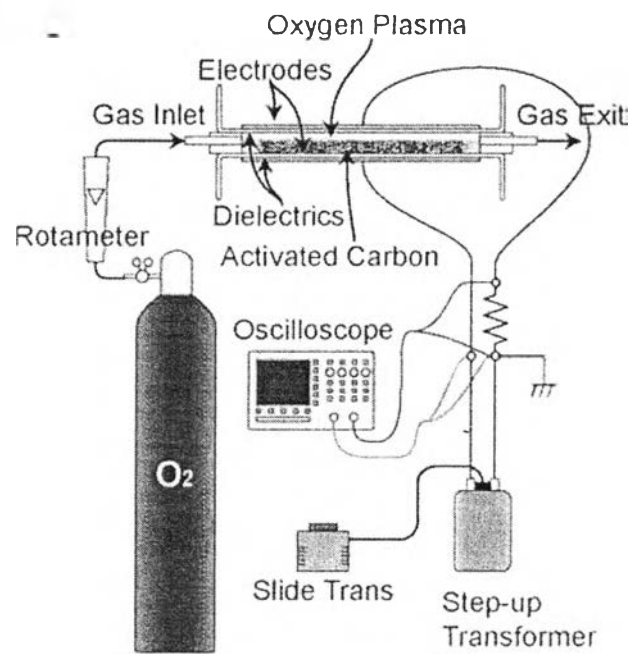

Figure 2.14 Experiment Set up of Dielectric Barrier Discharge Plasma (DBD) (Agostino *et al.*, 2005).

DBD plasmas are normally operated in one of the parallel-plate (Figure 2.15) or cylindrical (Figure 2.16) configurations. The parallel-plate configuration is used to surface treat fast-moving webs and films, and the annular volume of the cylindrical configuration is used to treat airflows for ozone production. At least one electrode of these geometries is covered with an insulating dielectric barrier to prevent real currents from flowing from the discharge volume to the electrodes and power supply.

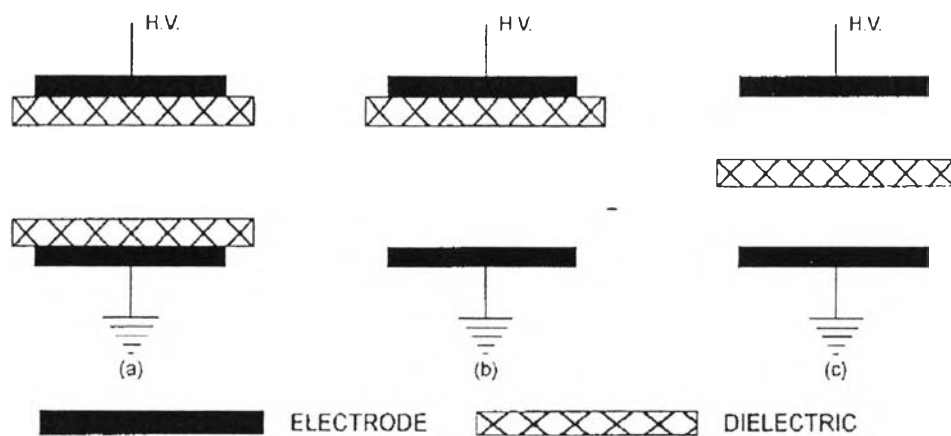

Figure 2.15 Schematic Diagram of Parallel-Plate DBD Plasma Source Configurations.

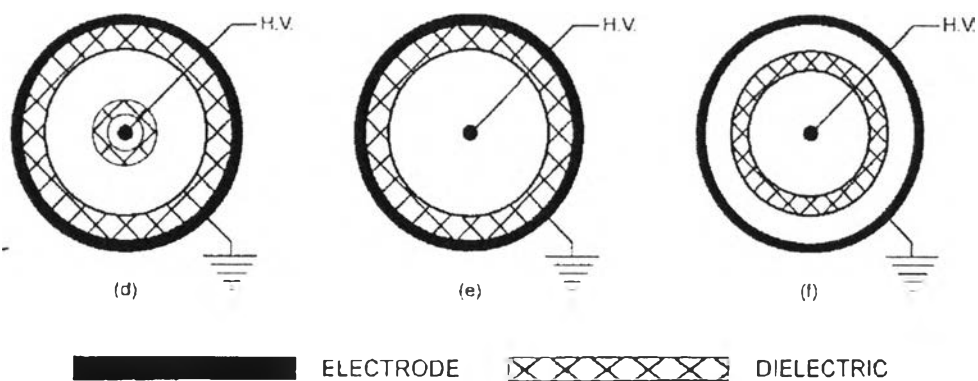

Figure 2.16 Schematic Diagram of Cylindrical DBD Plasma Source Configurations.

2.4 Interaction of Plasmas with Polymer Surfaces

In the plasma treatment of polymers, energetic particles and photons generated in the plasma interact strongly with the polymer surface, usually via free radical chemistry. In plasma which does not give rise to thin film deposition, four major effects on surfaces are normally observed. Each is always present to some degree, but one may be favored over the others, depending on the substrate and the

gas chemistry, the reactor design, and the operating parameters. The four major effects are:

- 1.) Surface cleaning, that is, removal of organic contamination that interferes with adhesion processes.
- 2.) Ablation or etching of material from the surface, it is important for cleaning of badly contaminated surface, for the removal of weak boundary and increase the surface area.
- 3.) Cross-linking of near-surface molecules, which can cohesively strengthen the surface layer.
- 4.) Modification of surface-chemical structure, which can occur during plasma treatment itself, and upon re-exposure of the treated part to air, at which time residual free radicals can react with atmospheric oxygen or water vapor.

Plasma treatment can be used with great effect to improve the bond strength of polymer to fibre and polymer to polymer combinations. In these cases, the improved adhesion results from both increased wettability of the treated substrate and the modification of surface chemistry of the polymer (Mittal *et al.*,2000)

2.5 Literature Survey on Surface Modification of Polymers by Plasma Treatment

Plasma treatment is frequently used for the improvement of adhesion and wettability of polymeric materials, and it has been reported by a number of authors. The mechanisms of surface functionalization of polymeric substrates are different from the gas-phase processes. The advantage of this technique is that plasma treatment only changes the uppermost atomic layers of a material surface without modifying the bulk properties. The amount of toxic byproducts is low compared to other methods.

Yang and Gupta (2004) demonstrated that an atmospheric-pressure plasma was generated by a RF discharge in a gas mixture of helium and oxygen could be used to modify PET surfaces. It was found that contact angle could be

reduced from 70 to 28° in less than 1 s of exposure time, and analysis on ion energy suggested that ions have no direct contribution to the surface modification. The absorption spectroscopy measurements indicated the presence of ozone and oxygen atoms that are responsible for the surface modification.

In 2006, Dumitrascu *et al.* reported the modification of woven commercial natural, synthetic and mixed fabrics surface produce by a dielectric barrier discharge plasma, which is run in air, argon and nitrogen at atmospheric pressure. They resulted that a DBD plasma can be used to modify in a very uniform way the surface of textile materials, leading to enhanced hydrophilicity. The enhanced wettability and wickability appeared to be strongly increased within the first 0.1–0.2 s of treatment. Any subsequent surface modification following longer treatment (>1.0 s) was less important. The increased wettability could be attributed to the increased level of oxidation, where supplementary polar functionalities are created on the fabric fibre surface, as observed by X-ray photoelectron spectroscopy (XPS).

De Geyter *et al.* (2007) studied modification of polyester (PET) and polypropylene (PP) film by a dielectric barrier discharge in air, helium, and argon atmosphere at medium pressure (5.0 kpa). It was found that the polymer films modified in air, helium, and argon shown a remarkable increase in hydrophilicity due to the implantation of oxygen-containing group, such as C–O, O–C=O, and C=O. In the formation of oxygen-containing functionalities than an argon plasma, which is more efficient than helium plasma. In an plasma, most of the created radicals at the polymer surface will quickly react with an oxygen particle, resulting in an efficient implantation of oxygen functionalities.

The primary effect of the plasma treatment was on surface roughness, in good accordance with atomic force microscopy (AFM) roughness data. A AFM study was done by Poletti *et al.* (2003) to quantify the effect of gas composition on the surface roughness. Figure 2.17 shows AFM images of the untreated and the 1 min and 2 min air plasma treated PET samples. The surface of the untreated PET textile appeared to be flatter compared to the treated samples. The treated samples showed that the air plasma treatment induced pits and micropores whose density, depth and size increased as a function of exposure time.

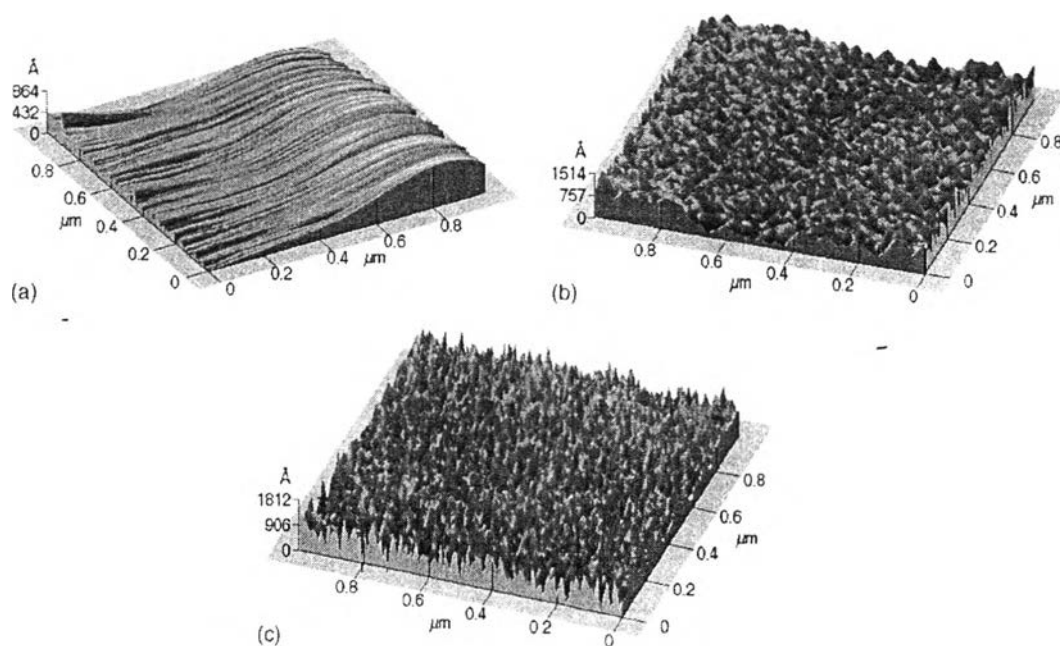

Figure 2.17 3-D views of AFM Images of PET Textile Surface. (a) Untreated Surface; (b) 60 s Treated Surface; (c) 120 s Treated Surface

Also in 2007, Park *et al.* studied on effect of dielectric barrier discharge on surface modification characteristic of polyimide film. The DBD plasma treatment power was fixed at 12 kV and medium frequency of 30 kHz, and the treatment temperature was kept below 35°C. It was found that the number of C=O and C–O–C species on the PI surface could be increased after the DBD plasma treatment because of the oxidation in air of the active species. Also, the R_a value of the PI film surfaces were confirm by AFM. They result that the adhesion of the PI film with the mixed gas between N_2 and air at treatment time 5 min was much higher than untreated sample.

Bae *et al.* (2001) reported that the TGA data where no significant deterioration of morphology of PP membranes was observed by plasma treatment. Both virgin and plasma treated PP membranes were thermally stable up to 200°C, even though slight weight loss was observed above 220°C for the plasma treated PP samples. This was probably due to the degradation of small amount of short

molecules not strongly bound to PP surface. Results shown that tensile strength of PP membranes before and after plasma treatment. Also, no significant difference was observed in mechanical strength between the two types of PP membranes.

In 2008, Khorasani *et al.* modified the surface of poly (L-lactic acid) (PLLA) and poly (D, L-lactic acid-coglycolic acid) (PLGA) for improvement of nerve cell adhesion by using Radio frequency (RF) plasma treatment in O₂. It was found that the hydrophilicity increase greatly after O₂ plasma treatment. The results showed that improved cell adhesion was attributed to the combination of surface chemistry and surface wettability during plasma treatment. Cell culture result showed that B65 nervous cell attachment and growth on the plasma treated PLLA was much higher than an unmodified sample and PLGA.

Yang *et al.* (2009) investigated the effect of a glow discharge plasma treatment can incorporated polar functional group onto the surface of the PET film causing decrease in the contact angle and rise in surface free energy. The decrease of contact angle suggests that the formation of hydrophilic groups on the plasma treated polymer film surface. They explained that the plasma creates radical species on the polymer surface, mainly through polymer chain scission or hydrogen abstraction by bombardment of plasma particle. This species can combine with oxygen in the air, thus also contributing to increase the amount of polar groups such as -OH, C=O, COOH and COO⁻ on the plasma treated polymer surfaces.

Zhang and Fang (2009) reported the modification of polyester fabrics by plasma treated with a dielectric barrier discharge (DBD) in air/Ar at atmospheric pressure and at a power of 300 W. The SEM images shown that the untreated polyester fiber had smooth surface (Figure 2.18 a.) but the treated with plasma had an evident change with the presence of grooves in the fiber surface morphology (Figure 2.18 b.). The roughness indicated that etching action had occurred to the fiber surface.

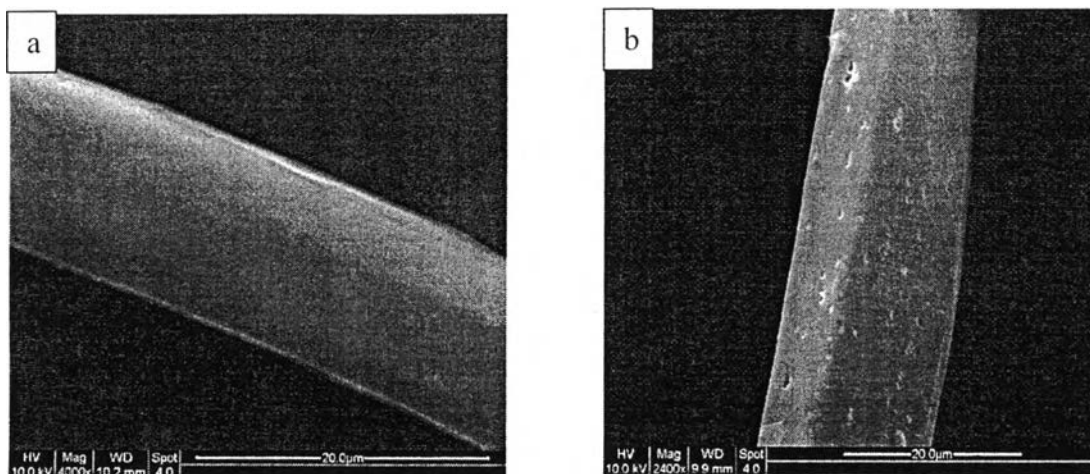

Figure 2.18 SEM images of the Polyester Fibers, (a) Untreated; (b) air/Ar Plasma Treated at a Dielectrics Space of 3 mm for 150 s.